

CATALOG

International pin and sleeve devices

UL/CSA standard



- Safe products tested and approved by third party testing laboratories
- Durable in tough conditions and environments
- Reliable thanks to high quality contacts
- Cost-saving, designed for quick and easy installation

Our international pin and sleeve devices are part of the comprehensive program of high quality low voltage products for demanding users. These products are used for connection of equipment in all kind of applications where it 's necessary to connect and disconnect. Reliable, durable and safe, Amphenol's industrial plugs and receptacles are the perfect choice for your application.

Table of contents

004-007	Introduction and catalog number guide - International pin and sleeve devices
008 009-012	Easy and Safe Description and ordering information
013-017	Tough and Safe Description and ordering information
018-019	Accessories
020-021	Tough and Safe Food and Beverage Description and ordering information
022 023-024	Critical and Safe Description and ordering information
025-026	Critical & Safe Food and Beverage Description and ordering information
027-031	Technical specifications
032-037	Approximate dimensions Drawings
038	Technical characteristics Easy and Safe
039	Tough and Safe
040	Tough and Safe Food and Beverage
041	Critical & Safe
042	Critical & Safe Food and Beverage
043	Notes

International pin and sleeve devices

A perfect choice

Our international pin and sleeve devices are a part of the comprehensive program of high quality low voltage products for demanding users.

The design and materials of our plugs and receptacles have been continuously improved during the more than 60 years we have been in this business. The range covers products up to 100 A and 690 V, and are certified for applicable IEC and UL standards by external certification bodies. We aim to meet customers' requirements while taking environmental aspects into consideration.

Our industrial plugs and receptacles are the right choice for applications with high demand for safety, durability, reliability and cost saving for the end user.

- **Safety** - Tested and approved by third-party certification bodies.
- **Durability** - Materials chosen for high resistance to most chemicals, to UV light and to impact.
- **Reliability** - High quality self-cleaning and calibrated contacts ensure reliability.
- **Cost saving** - Designed for easy installation and long time use, ABB's complete portfolio of plugs and sockets are available worldwide.

Perfect for the job

Different applications and environments require different products. To make your choice easier, we have categorized our range into three groups. All groups have one feature in common : safety.

Superior performance

Our plugs and receptacles comply with high quality standards required for reliability and safety. Some are made of heavy-duty plastic (PBT), others of metal. Some have a straightforward functionality while others have advanced features, perfect for demanding applications.

Drives productivity

The reliability of our plugs and receptacles will help you maintain high up-time in operations. You will avoid unwanted interruptions.

Safety first

Safety is always important. By choosing our plugs and receptacles, you minimize the risk of short circuits. You ensure maximum personal safety for anyone near your equipment.



**EASY
& SAFE**

- Select Easy & Safe products for adequate functionality and ergonomic design.



**TOUGH
& SAFE**

- Select Tough & Safe products for best performance in demanding and heavy-duty applications.



**CRITICAL
& SAFE**

- Select Critical & Safe products for the highest safety in fixed installations.

The structure of our main catalog is based on these three groups. Look for the three different symbols to make your choice.

**Our industrial plugs and receptacles —
a complete offering**

- Approved according to IEC 60 309-1, -2, -4
- Ranging from 20 A up to 100 A
- IP44 (splashproof), IP67 and IP69K (watertight)
- With contacts that are self-cleaning and calibrated to maintain accurate contact pressure, quality and performance over time
- Critical & Safe and Tough & Safe products have stainless steel external screw.
- Clearly marked terminals
- Interlocked receptacles for vertical mounting



Catalog number guide

Part number configuration

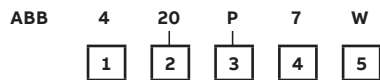

Catalog number guide		
1 Number of wires	3	2 Poles, 3 Wire
	4	3 Poles, 4 Wire
	5	4 Poles, 5 Wire
2 Ampere rating	20	20A
	30	30A
	60	60A
	100	100A
3 Type	P	Plugs
	C	Connectors
	Rx	Receptacles
	Bx	Inlets
	Mechanical interlocked receptacles	MI
	MF	Fused
	MB	Breakered
4 Position of earthing sleeve		According to IEC 60 309-2 clock1
5 Degree of protection	W	IP67 and IP69K2
5 Degree of protection	WN	IP67 and IP69K NSF (Food and beverage)
		SP IP44 Splashproof
		E IP67 Watertight

1 See clock on next page.

Note: 5 Degree of protection WN IP67 and IP69K NSF (Food and beverage)
 SP IP44 Splashproof
 E IP67 Watertight

Industrial plugs and receptacles

IEC 60309-2 “clock”

$I_e = 20A, 30A, 60A, 100A$
 $U_e = 50 - 600 V$

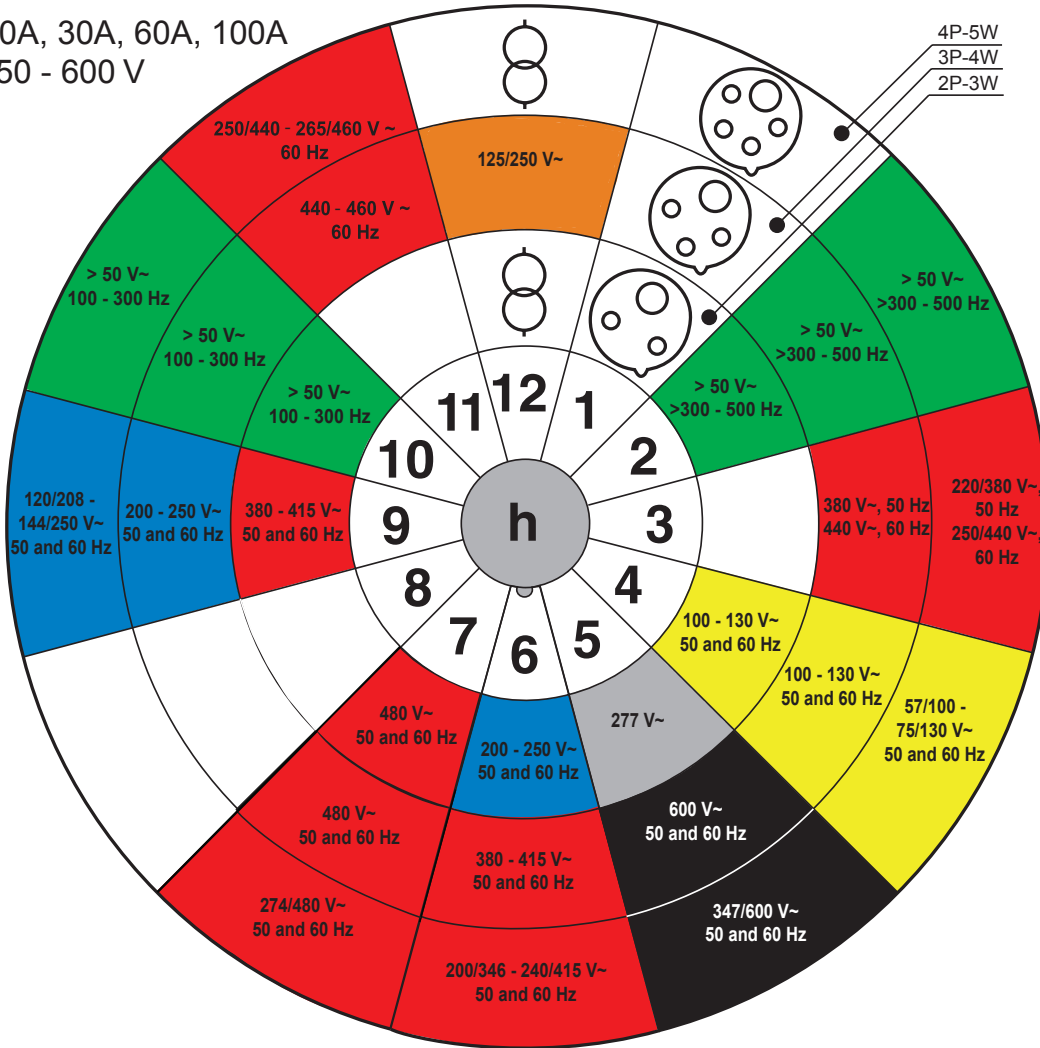

Standard voltages - Color codes according to IEC60309-1, -2

Position of earthing sleeve according to IEC 60309-2 (clock)	2P-3W	3P-4W	4P-5W
1	<input type="checkbox"/> Optional voltage (not stated below)	<input type="checkbox"/> Optional voltage (not stated below)	<input type="checkbox"/> Optional voltage (not stated below)
2	<input checked="" type="checkbox"/> >50 V~ >300 - 500 Hz	<input checked="" type="checkbox"/> >50 V~ >300 - 500 Hz	<input checked="" type="checkbox"/> >50 V~ >300 - 500 Hz
3	<input type="checkbox"/> Not used	<input checked="" type="checkbox"/> 380 V~ 50 Hz, 440 V 60 Hz	<input checked="" type="checkbox"/> 220/380 V~ 50 Hz, 250/440 V 60 Hz
4	<input checked="" type="checkbox"/> 100 - 130 V~ 50 and 60 Hz	<input checked="" type="checkbox"/> 100 - 130 V~ 50 and 60 Hz	<input checked="" type="checkbox"/> 57/100 - 75/130 V~ 50 and 60 Hz
5	<input type="checkbox"/> 277 V~ 60 Hz	<input checked="" type="checkbox"/> 600 V~ 50 and 60 Hz	<input checked="" type="checkbox"/> 600 V~ 50 and 60 Hz
6	<input checked="" type="checkbox"/> 200 - 250 V~ 50 and 60 Hz	<input checked="" type="checkbox"/> 380 - 415 V~ 50 and 60 Hz	<input checked="" type="checkbox"/> 200/346 - 240/415 V~ 50 and 60 Hz
7	<input checked="" type="checkbox"/> 480 V~ 60 Hz	<input checked="" type="checkbox"/> 480 V~ 50 and 60 Hz	<input checked="" type="checkbox"/> 480 V~ 50 and 60 Hz
8	<input type="checkbox"/> Not used		<input type="checkbox"/> Not used
9	<input checked="" type="checkbox"/> 380 - 415 V~ 50 and 60 Hz	<input checked="" type="checkbox"/> 200 - 250 V~ 50 and 60 Hz	<input checked="" type="checkbox"/> 120/208 - 144/250 V~ 50 and 60 Hz
10	<input checked="" type="checkbox"/> >50 V~ 100 - 300 Hz	<input checked="" type="checkbox"/> >50 V~ 100 - 300 Hz	<input checked="" type="checkbox"/> >50 V~ 100 - 300 Hz
11 Mainly for marine installations	<input type="checkbox"/> Not used	<input checked="" type="checkbox"/> 440 - 460 V~ 50 and 60 Hz	<input checked="" type="checkbox"/> 250/440 - 265/460 V~ 50 and 60 Hz
12 Supply from isolating transformer	<input type="checkbox"/> Supply from isolating transformer	<input checked="" type="checkbox"/> 125/250 V~ 50 and 60	<input type="checkbox"/> Supply from isolating transformer



Industrial plugs and receptacles

Easy & Safe

Our **International Pin and Sleeve devices** implement a strong low-voltage offer. Easy & Safe is a high quality product range for basic applications.

In most installations, industrial plugs and receptacles are part of the exterior, for this reason, it is important that they are well designed. The modern design add value to each installation or OEM equipment.

Protect your contacts with Easy & Safe IP67

The biggest addition in this series is the new designed products with IP67 ingress protection. IP67 is a protection class that guarantees protection from water and dust. Although water or dust rarely occur in some applications, the liquids or dirt may get into the contacting surfaces during the products lifetime, which can affect the contacts performance. This in turn can lead to overheating, burnt contacts and the need to replace plugs and receptacles.

In the worst scenario fluids or dust reach the contact parts, which can lead to accidents with injuries and damage the connected equipment.

Electrical contacts protected against liquids and dirt retain their performance over time. High contact performance means reliability, reduced downtime and reduced maintenance costs. Contact parts of our connectors are manufactured with high precision from solid brass. The innovative design means that the contacts seem self-cleaning during connection and disconnection while keeping the contact area

free from arching.

Next generation of IP44 plugs and connectors

Some features of the IP67 products are also implemented in the IP44 plugs and connectors. The new cable gland offers improved sealing and strain and relief, functions with a wider span of cables. We have also implemented the new family design of our Industrial plugs and receptacles.

Applications

Easy & Safe series is an excellent choice in most applications where high reliability and safety are required.

For example:

- Data centers
- Industrial applications
- Food and beverage industries
- Infrastructure applications
- Construction sites
- Mines
- Marine applications connection of reefer containers

For tough applications with specific requirements for UV resistance, chemical resistance, mechanical resistance, our Tough & Safe series is still the best option.



Easy & Safe

Product Overview

Plugs



Type ABB_P_SP
20A-30A, IP44



Type ABB_P_E
20A-30A, IP67

Connectors



Type ABB_C-SP
20A-30A, IP44



Type ABB_C-E
20A-30A, IP67

Inlets

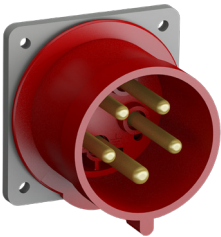

For panel mounting with unified straight flange, Type ABB_BU-SP
20A-30A, IP44

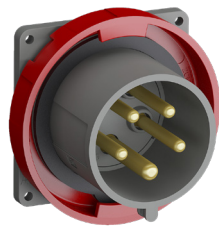

For panel mounting with unified straight flange, Type ABB_B-E
20A-30A, IP67

Receptacles

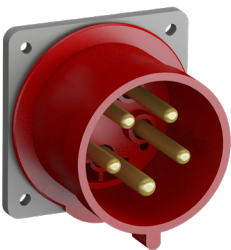

For panel mounting with unified straight flange, Type ABB_RU-SP
20A-30A, IP44



For panel mounting with unified straight flange, Type ABB_R-E
20 A - 30A, IP67

Easy & Safe Features



A complete range of IP44 and IP67 Industrial plugs, connectors, receptacles outlets and inlets in a new attractive and functional design. IP67 products are perfect for applications where you need to protect contacts from water and dust. Robust design and unique self-cleaning calibrated contacts bring reliability, prevent arcing, reduce downtime and thus lower maintenance.

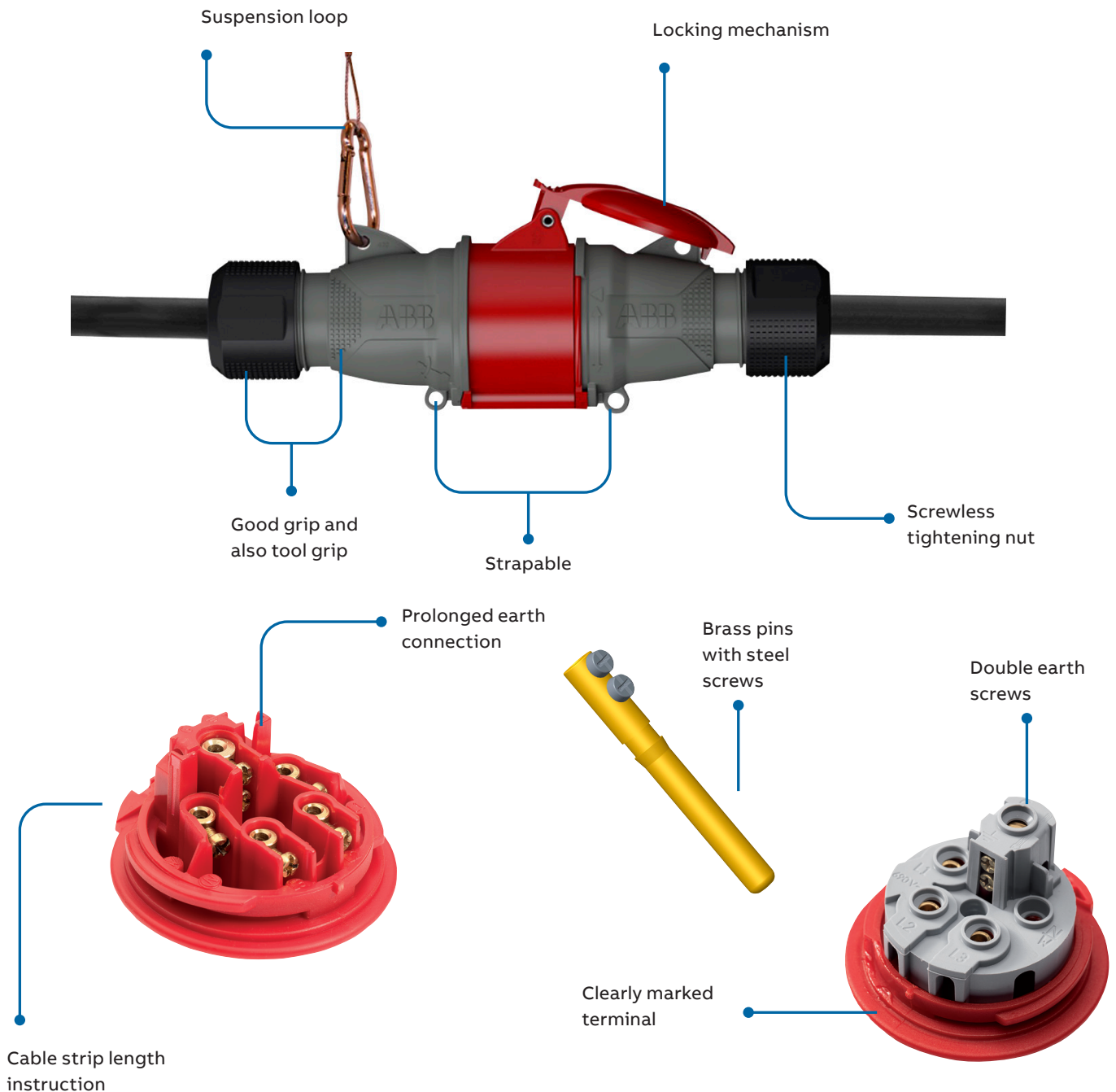

Easy & Safe IP44

Ordering Information



Easy
and Safe
Devices
IP44



Amp	Poles and wires	Voltage (VAC*)	Clock hour	Plugs	Connectors	Receptacle	Inlet
20	2P3W	100-130	4h	ABB320P4SP	ABB320C4SP	ABB320RU4SP	ABB320BU4SP
20	2P3W	277	5h	ABB320P5SP	ABB320C5SP	ABB320RU5SP	ABB320BU5SP
16/20*	2P3W	200-250	6h	ABB316P6SP	ABB316C6SP	ABB316RU6SP	ABB316BU6SP
20	2P3W	480	7h	ABB320P7SP	ABB320C7SP	ABB320RU7SP	ABB320BU7SP
20	3P4W	380 50 Hz/ 440 60 Hz	3h	ABB420P3SP	ABB420C3SP	ABB420RU3SP	ABB420BU3SP
20	3P4W	100-130	4h	ABB420P4SP	ABB420C4SP	ABB420RU4SP	ABB420BU4SP
20	3P4W	3Ø 600	5h	ABB420P5SP	ABB420C5SP	ABB420RU5SP	ABB420BU5SP
16/20*	3P4W	380-415	6h	ABB416P6SP	ABB416C6SP	ABB416RU6SP	ABB416BU6SP
20	3P4W	3Ø 480	7h	ABB420P7SP	ABB420C7SP	ABB420RU7SP	ABB420BU7SP
20	3P4W	3Ø 200-250	9h	ABB420P9SP	ABB420C9SP	ABB420RU9SP	ABB420BU9SP
20	3P4W	440 - 460	11h	ABB420P11SP	ABB420C11SP	ABB420RU11SP	ABB420BU11SP
20	3P4W	100/250	12h	ABB420P12SP	ABB420C12SP	ABB420RU12SP	ABB420BU12SP
20	4P5W	100-130	4h	ABB520P4SP	ABB520C4SP	ABB520RU4SP	ABB520BU4SP
20	4P5W	3ØY 347/600	5h	ABB520P5SP	ABB520C5SP	ABB520RU5SP	ABB520BU5SP
16/20*	4P5W	200/346-240/415	6h	ABB516P6SP	ABB516C6SP	ABB516RU6SP	ABB516BU6SP
20	4P5W	3ØY 277/480	7h	ABB520P7SP	ABB520C7SP	ABB520RU7SP	ABB520BU7SP
20	4P5W	3ØY 120/208-144/250	9h	ABB520P9SP	ABB520C9SP	ABB520RU9SP	ABB520BU9SP
20	4P5W	250/440 - 265/460	11h	ABB520P11SP	ABB520C11SP	ABB520RU11SP	ABB520BU11SP
30	2P3W	100-130	4h	ABB330P4SP	ABB330C4SP	ABB330RU4SP	ABB330BU4SP
30	2P3W	277	5h	ABB330P5SP	ABB330C5SP	ABB330RU5SP	ABB330BU5SP
30/32*	2P3W	200-250	6h	ABB332P6SP	ABB332C6SP	ABB332RU6SP	ABB332BU6SP
30	2P3W	480	7h	ABB330P7SP	ABB330C7SP	ABB330RU7SP	ABB330BU7SP
30	3P4W	380 50 Hz/440 60 Hz	3h	ABB430P3SP	ABB430C3SP	ABB430RU3SP	ABB430BU3SP
30	3P4W	100-130	4h	ABB430P4SP	ABB430C4SP	ABB430RU4SP	ABB430BU4SP
30	3P4W	3Ø 600	5h	ABB430P5SP	ABB430C5SP	ABB430RU5SP	ABB430BU5SP
30/32*	3P4W	380-415	6h	ABB430P6SP	ABB430C6SP	ABB430RU6SP	ABB430BU6SP
30	3P4W	3Ø 480	7h	ABB430P7SP	ABB430C7SP	ABB430RU7SP	ABB430BU7SP
30	3P4W	3Ø 200-250	9h	ABB430P9SP	ABB430C9SP	ABB430RU9SP	ABB430BU9SP
30	3P4W	440 - 460	11h	ABB430P11SP	ABB430C11SP	ABB430RU11SP	ABB430BU11SP
30	3P4W	100/250	12h	ABB430P12SP	ABB430C12SP	ABB430RU12SP	ABB430BU12SP
30	4P5W	100-130	4h	ABB530P4SP	ABB530C4SP	ABB530RU4SP	ABB530BU4SP
30	4P5W	3ØY 347/600	5h	ABB530P5SP	ABB530C5SP	ABB530RU5SP	ABB530BU5SP
30/32*	4P5W	200/346-240/415	6h	ABB532P6SP	ABB532C6SP	ABB532RU6SP	ABB532BU6SP
30	4P5W	3ØY 277/480	7h	ABB530P7SP	ABB530C7SP	ABB530RU7SP	ABB530BU7SP
30	4P5W	3ØY 120/208-144/250	9h	ABB530P9SP	ABB530C9SP	ABB530RU9SP	ABB530BU9SP
30	4P5W	250/440 - 265/460	11h	ABB530P11SP	ABB530C11SP	ABB530RU11SP	ABB530BU11SP

UL/CSA approved and CE compliant

* 16/20 - 30/32: Dual Certification



Easy & Safe IP67

Ordering Information

Easy and
Safe
Devices
IP67

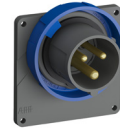

Amp	Poles and wires	Voltage (VAC*)	Clock hour	Plugs	Connectors	Receptacle	Inlet
20	2P3W	100-130	4h	ABB320P4E	ABB320C4E	ABB320R4E	ABB320B4E
20	2P3W	277	5h	ABB320P5E	ABB320C5E	ABB320R5E	ABB320B5E
16/20*	2P3W	200-250	6h	ABB316P6E	ABB316C6E	ABB316R6E	ABB316B6E
20	2P3W	480	7h	ABB320P7E	ABB320C7E	ABB320R7E	ABB320B7E
20	3P4W	380 50 Hz/440 60 Hz	3h	ABB420P3E	ABB420C3E	ABB420R3E	ABB420B3E
20	3P4W	100-130	4h	ABB420P4E	ABB420C4E	ABB420R4E	ABB420B4E
20	3P4W	3Ø 600	5h	ABB420P5E	ABB420C5E	ABB420R5E	ABB420B5E
16/20*	3P4W	380-415	6h	ABB416P6E	ABB416C6E	ABB416R6E	ABB416B6E
20	3P4W	3Ø 480	7h	ABB420P7E	ABB420C7E	ABB420R7E	ABB420B7E
20	3P4W	3Ø 200-250	9h	ABB420P9E	ABB420C9E	ABB420R9E	ABB420B9E
20	3P4W	440 - 460	11h	ABB420P11E	ABB420C11E	ABB420R11E	ABB420B11E
20	3P4W	100/250	12h	ABB420P12E	ABB420C12E	ABB420R12E	ABB420B12E
20	4P5W	100-130	4h	ABB520P4E	ABB520C4E	ABB520R4E	ABB520B4E
20	4P5W	3ØY 347/600	5h	ABB520P5E	ABB520C5E	ABB520R5E	ABB520B5E
16/20*	4P5W	200/346-240/415	6h	ABB516P6E	ABB516C6E	ABB516R6E	ABB516B6E
20	4P5W	3ØY 277/480	7h	ABB520P7E	ABB520C7E	ABB520R7E	ABB520B7E
20	4P5W	3ØY 120/208-144/250	9h	ABB520P9E	ABB520C9E	ABB520R9E	ABB520B9E
20	4P5W	250/440 - 265/460	11h	ABB520P11E	ABB520C11E	ABB520R11E	ABB520B11E
30	2P3W	100-130	4h	ABB330P4E	ABB330C4E	ABB330R4E	ABB330B4E
30	2P3W	277	5h	ABB330P5E	ABB330C5E	ABB330R5E	ABB330B5E
30/32*	2P3W	200-250	6h	ABB332P6E	ABB332C6E	ABB332R6E	ABB332B6E
30	2P3W	480	7h	ABB330P7E	ABB330C7E	ABB330R7E	ABB330B7E
30	3P4W	380 50 Hz/440 60 Hz	3h	ABB430P3E	ABB430C3E	ABB430R3E	ABB430B3E
30	3P4W	100-130	4h	ABB430P4E	ABB430C4E	ABB430R4E	ABB430B4E
30	3P4W	3Ø 600	5h	ABB430P5E	ABB430C5E	ABB430R5E	ABB430B5E
30/32*	3P4W	380-415	6h	ABB432P6E	ABB432C6E	ABB432R6E	ABB432B6E
30	3P4W	3Ø 480	7h	ABB430P7E	ABB430C7E	ABB430R7E	ABB430B7E
30	3P4W	3Ø 200-250	9h	ABB430P9E	ABB430C9E	ABB430R9E	ABB430B9E
30	3P4W	440 - 460	11h	ABB430P11E	ABB430C11E	ABB430R11E	ABB430B11E
30	3P4W	100/250	12h	ABB430P12E	ABB430C12E	ABB430R12E	ABB430B12E
30	4P5W	220/380 - 250/440	3h	ABB530P3E	ABB530C3E	ABB530R3E	ABB530B3E
30	4P5W	100-130	4h	ABB530P4E	ABB530C4E	ABB530R4E	ABB530B4E
30	4P5W	3ØY 347/600	5h	ABB530P5E	ABB530C5E	ABB530R5E	ABB530B5E
30/32*	4P5W	200/346-240/415	6h	ABB532P6E	ABB532C6E	ABB532R6E	ABB532B6E
30	4P5W	3ØY 277/480	7h	ABB530P7E	ABB530C7E	ABB530R7E	ABB530B7E
30	4P5W	3ØY 120/208-144/250	9h	ABB530P9E	ABB530C9E	ABB530R9E	ABB530B9E
30	4P5W	250/440 - 265/460	11h	ABB530P11E	ABB530C11E	ABB530R11E	ABB530B11E

UL/CSA approved and CE compliant

* 16/20 - 30/32: Dual Certification

Tough & Safe Features

Tough and Safe is the product range for application in environments that have high demand for functionality and safety.

The robust housing is made of PBT plastic. The range Tough & Safe is available as watertight (IP67, 20-100 A) and splashproof (IP44, 60 A). The devices are equipped with internal and external cable clamps. The 100 A devices are equipped with two screws on each terminal.

- IP67 Watertight or IP44 Splashproof
- 20-100 A, 50-690 VAC
- IEC 60 309-1, -2
- All external screws are made of stainless steel

Application examples

- Industry/workshops
- Harbours/shipyards
- Mines
- Food and beverage

Clear marking, at the front and the rear of the terminals
Ground \perp
Neutral N
Phase L1, L2, L3

External screws made of stainless steel

Internal and external cable clamp

Brass pins

Type: 463P6W

Rear terminals, raised lettering, identification contacts

Robust plastic housing that withstands most chemicals found in industrial environments

Two screws at each terminal to assure safe and reliable cable connection

Watertight chloroprene onion skin grommet

Type: 563C6W

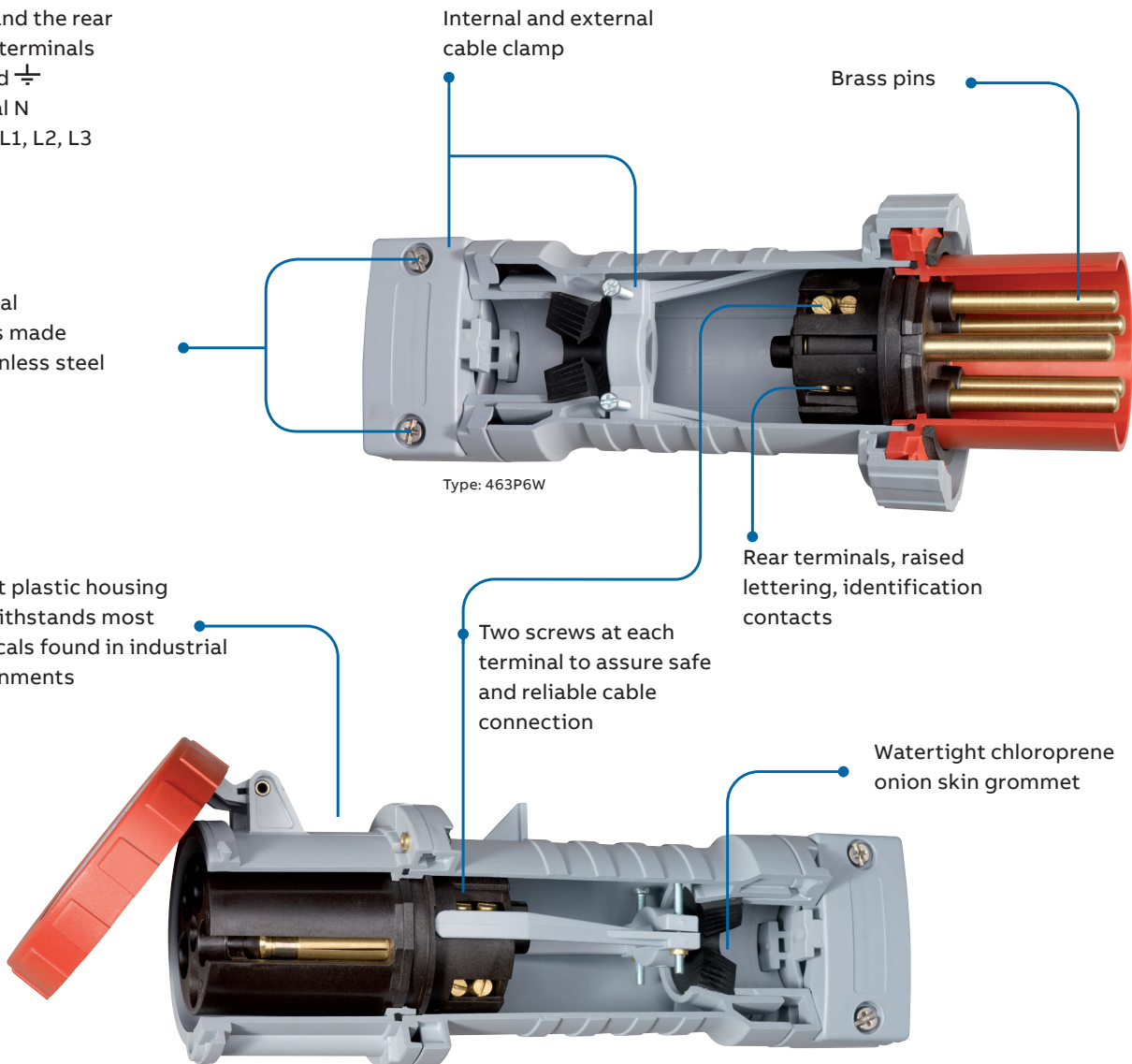



Tough & Safe

Product Overview

Plugs

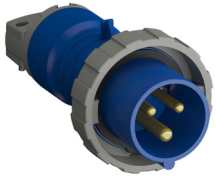

Type ABB_P,
20A-30A, IP67



Type ABB_P,
60A-100A, IP67

Connectors



Type ABB_C,
20A-30A, IP67



Type ABB_C, 60A-100A, IP67

Inlets



For panel mounting with
straight flange, Type ABB_B
60 A, IP44



For panel mounting with straight
flange, Type ABB_B_W,
20A-100A, IP67

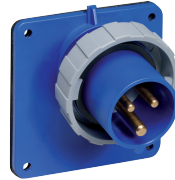

For panel mounting with
straight flange, Type ABB_B_W
20A-30A, IP67

Receptacles



For panel mounting with unified
straight flange, Type ABB_R
60 A, IP44



For panel mounting with unified
angled flange, Type ABB_R_W,
20A-30A



For panel mounting with unified
straight flange, Type ABB_R_W,
60A-100A



Tough & Safe IP44

Ordering information

Tough
and Safe
Devices
IP44



Amp	Poles and wires	Voltage (VAC*)	Clock hour	Plugs	Connectors	Receptacle	Inlet	Back Box + Flange
60	2P3W	100-130	4h	ABB360P4	ABB360C4	ABB360R4	ABB360B4	BB60+BBA60
60	2P3W	277	5h	ABB360P5	ABB360C5	ABB360R5	ABB360B5	BB60+BBA60
60/63*	2P3W	200-250	6h	ABB363P6	ABB363C6	ABB363R6	ABB363B6	BB60+BBA60
60	2P3W	480	7h	ABB360P7	ABB360C7	ABB360R7	ABB360B7	BB60+BBA60
60	3P4W	3Ø 600	5h	ABB460P5	ABB460C5	ABB460R5	ABB460B5	BB60+BBA60
60/63*	3P4W	380-415	6h	ABB463P6	ABB463C6	ABB463R6	ABB463B6	BB60+BBA60
60	3P4W	3Ø 480	7h	ABB460P7	ABB460C7	ABB460R7	ABB460B7	BB60+BBA60
60	3P4W	3Ø 200-250	9h	ABB460P9	ABB460C9	ABB460R9	ABB460B9	BB60+BBA60
60	3P4W	125/250	12h	ABB460P12	ABB460C12	ABB460R12	ABB460B12	BB60+BBA60
60	3P4W	3Ø 600	5h	ABB560P5	ABB560C5	ABB560R5	ABB560B5	BB60+BBA60
60/63*	3P4W	380-415	6h	ABB563P6	ABB563C6	ABB563R6	ABB563 B6	BB60+BBA60
60	3P4W	3Ø 480	7h	ABB560P7	ABB560C7	ABB560R7	ABB560B7	BB60+BBA60
60	3P4W	3Ø 200-250	9h	ABB560P9	ABB560C9	ABB560R9	ABB560B9	BB60+BBA60

UL, CSA approved and CE compliant

* 60/63: Dual Certification



Tough & Safe IP67

Ordering information

Tough
and Safe
Devices
IP67



Amp	Poles and wires	Voltage (VAC*)	Clock hour	Plugs	Connectors	Receptacle	Inlet	Back Box
20	2P3W	100-130	4h	ABB320P4W	ABB320C4W	ABB320R4W	ABB320B4W	BB30
20	2P3W	277	5h	ABB320P5W	ABB320C5W	ABB320R5W	ABB320B5W	BB30
16/20*	2P3W	200-250	6h	ABB316P6W	ABB316C6W	ABB316R6W	ABB316B6W	BB30
20	2P3W	480	7h	ABB320P7W	ABB320C7W	ABB320R7W	ABB320B7W	BB30
20	3P4W	3Ø 600	5h	ABB420P5W	ABB420C5W	ABB420R5W	ABB420B5W	BB30
16/20*	3P4W	380-415	6h	ABB416P6W	ABB416C6W	ABB416R6W	ABB416B6W	BB30
20	3P4W	3Ø 480	7h	ABB420P7W	ABB420C7W	ABB420R7W	ABB420B7W	BB30
20	3P4W	3Ø 200-250	9h	ABB420P9W	ABB420C9W	ABB420R9W	ABB420B9W	BB30
20	3P4W	125/250	12h	ABB420P12W	ABB420C12W	ABB420R12W	ABB420B12W	BB30
20	4P5W	3ØY 347/600	5h	ABB520P5W	ABB520C5W	ABB520R5W	ABB520B5W	BB30
16/20*	4P5W	200/346-240/415	6h	ABB516P6W	ABB516C6W	ABB516R6W	ABB516B6W	BB30
20	4P5W	3ØY 277/480	7h	ABB520P7W	ABB520C7W	ABB520R7W	ABB520B7W	BB30
20	4P5W	3ØY 120/208-144/250	9h	ABB520P9W	ABB520C9W	ABB520R9W	ABB520B9W	BB30
30	2P3W	100-130	4h	ABB330P4W	ABB330C4W	ABB330R4W	ABB330B4W	BB30
30	2P3W	277	5h	ABB330P5W	ABB330C5W	ABB330R5W	ABB330B5W	BB30
30/32*	2P3W	200-250	6h	ABB332P6W	ABB332C6W	ABB332R6W	ABB332B6W	BB30
30	2P3W	480	7h	ABB330P7W	ABB330C7W	ABB330R7W	ABB330B7W	BB30
30	3P4W	3Ø 600	5h	ABB430P5W	ABB430C5W	ABB430R5W	ABB430B5W	BB30
30/32*	3P4W	380-415	6h	ABB432P6W	ABB432C6W	ABB432R6W	ABB432B6W	BB30
30	3P4W	3Ø 480	7h	ABB430P7W	ABB430C7W	ABB430R7W	ABB430B7W	BB30
30	3P4W	3Ø 200-250	9h	ABB430P9W	ABB430C9W	ABB430R9W	ABB430B9W	BB30
30	3P4W	125/250	12h	ABB430P12W	ABB430C12W	ABB430R12W	ABB430B12W	BB30
30	4P5W	3ØY 347/600	5h	ABB530P5W	ABB530C5W	ABB530R5W	ABB530B5W	BB30
30/32*	4P5W	200/346-240/415	6h	ABB532P6W	ABB532C6W	ABB532R6W	ABB532B6W	BB30
30	4P5W	3ØY 277/480	7h	ABB530P7W	ABB530C7W	ABB530R7W	ABB530B7W	BB30
30	4P5W	3ØY 120/208-144/250	9h	ABB530P9W	ABB530C9W	ABB530R9W	ABB530B9W	BB30

UL, CSA, approved and CE compliant

* 16/20 - 30/32: Dual Certification



Tough & Safe IP67

Ordering information

Tough and Safe Devices IP67



Amp	Poles and wires	Voltage (VAC*)	Clock hour	Plugs	Connectors	Receptacle	Inlet	Back Box + Flange
60	2P3W	100-130	4h	ABB360P4W	ABB360C4W	ABB360R4W	ABB360B4W	BB60+BBA60
60	2P3W	277	5h	ABB360P5W	ABB360C5W	ABB360R5W	ABB360B5W	BB60+BBA60
60/63*	2P3W	200-250	6h	ABB363P6W	ABB363C6W	ABB363R6W	ABB363B6W	BB60+BBA60
60	2P3W	480	7h	ABB360P7W	ABB360C7W	ABB360R7W	ABB360B7W	BB60+BBA60
60	3P4W	3Ø 600	5h	ABB460P5W	ABB460C5W	ABB460R5W	ABB460B5W	BB60+BBA60
60/63*	3P4W	380-415	6h	ABB463P6W	ABB463C6W*	ABB463R6W*	ABB463B6W	BB60+BBA60
60	3P4W	3Ø 480	7h	ABB460P7W	ABB460C7W	ABB460R7W	ABB460B7W	BB60+BBA60
60	3P4W	3Ø 200-250	9h	ABB460P9W	ABB460C9W	ABB460R9W	ABB460B9W	BB60+BBA60
60	3P4W	125/250	12h	ABB460P12W	ABB460C12W	ABB460R12W	ABB460B12W	BB60+BBA60
60	4P5W	3ØY 347/600	5h	ABB560P5W	ABB560C5W	ABB560R5W	ABB560B5W	BB60+BBA60
60/63*	4P5W	200/346-240/415	6h	ABB563P6W	ABB563C6W	ABB563R6W	ABB563B6W	BB60+BBA60
60	4P5W	3ØY 277/480	7h	ABB560P7W	ABB560C7W	ABB560R7W	ABB560B7W	BB60+BBA60
60	4P5W	3ØY 120/208-144/250	9h	ABB560P9W	ABB560C9W	ABB560R9W	ABB560B9W	BB60+BBA60
100	2P3W	100-130	4h	ABB3100P4W	ABB3100C4W	ABB3100R4W	ABB3100B4W	BB100+BBA100
100	2P3W	277	5h	ABB3100P5W	ABB3100C5W	ABB3100R5W	ABB3100B5W	BB100+BBA100
100/125*	2P3W	200-250	6h	ABB3125P6W	ABB3125C6W	ABB3125R6W	ABB3125B6W	BB100+BBA100
100	2P3W	480	7h	ABB3100P7W	ABB3100C7W	ABB3100R7W	ABB3100B7W	BB100+BBA100
100	3P4W	3Ø 600	5h	ABB4100P5W	ABB4100C5W	ABB4100R5W	ABB4100B5W	BB100+BBA100
100/125*	3P4W	380-415	6h	ABB4125P6W	ABB4125C6W	ABB4125R6W	ABB4125B6W	BB100+BBA100
100	3P4W	3Ø 480	7h	ABB4100P7W	ABB4100C7W	ABB4100R7W	ABB4100B7W	BB100+BBA100
100	3P4W	3Ø 200-250	9h	ABB4100P9W	ABB4100C9W	ABB4100R9W	ABB4100B9W	BB100+BBA100
100	3P4W	125/250	12h	ABB4100P12W	ABB4100C12W	ABB4100R12W	ABB4100B12W	BB100+BBA100
100	4P5W	3ØY 347/600	5h	ABB5100P5W	ABB5100C5W	ABB5100R5W	ABB5100B5W	BB100+BBA100
100/125*	4P5W	200/346-240/415	6h	ABB5125P6W	ABB5125C6W	ABB5125R6W	ABB5125B6W	BB100+BBA100
100	4P5W	3ØY 277/480	7h	ABB5100P7W	ABB5100C7W	ABB5100R7W	ABB5100B7W	BB100+BBA100
100	4P5W	3ØY 120/208-144/250	9h	ABB5100P9W	ABB5100C9W	ABB5100R9W	ABB5100B9W	BB100+BBA100

UL, CSA, approved and CE compliant

* 60/63 - 100/125: Dual Certification

International pin and sleeve devices

Tough and Safe Accessories



Plugblocker

Lockout/tagout for plugs and inlets. Can be used for any IEC 60 309-1 and 60 309-2 plug or inlet.

To fit	Catalog number
Plugs 20A-100A	
Panel mounted inlets 20A-100A	CLF20-100
Surface mounted inlets 20A-100A	



Protective cover 20 – 100 A, IP44/67

Material in EPDM Rubber

For inlet and plug	Catalog number
20A, 2P+E	ABB GP320
20A, 3P+E	ABB GP420
20A, 3P+N+E	ABB GP520
30A, 2P+E and 3P+E	ABB GP330/430
30A, 3P+N+E	ABB GP530
60A, 2P+E, 3P+E and 3P+N+E	ABB GP60
100A, 2P+E, 3P+E and 3P+N+E	ABB GP100



Liquidtight adapter and wire mesh

For connector and plug	Liquidtight adapter Hub size	Liquidtight adapter Catalog number	Wire mesh Catalog number
20A 3-4W	½"	LAA12	5330WVG2
20A 5W, 30A 3-4W	½"	LAB12	5330WVG2
20A 5W, 30A 3-4W	¾"	LAB34	5333WVG3
30A 5W	¾"	LAC34	5333WVG3
30A 5W	1"	LAC100	5334WVG4
60A	1¼"	LAD125	5335WVG5
60A	¾"	LAD34	5333WVG3
100A	1¼"	LAE125	5335WVG5



Replacement lids for connector and receptacles

For connector and receptacle	Catalog number
3W 20A	CA320
4W 20A	CA420
5W 20A	CA520
3-4W 30A	CA343
5W 30A	CA530
60A	CA060
100A	CA100

International pin and sleeve devices

Tough and Safe Accessories



20° metal angle enclosure

For receptacle and inlet	Hub size	Catalog number
60A	1¼"	AE6-B125
60A	1½"	AE6-B150
100A	1½"	AE10-B150
100A	2"	AE10-B200



20° metal angle adapter

For receptacle and inlet	Catalog number
60A	AA6L
100A	AA10L



Junction box

For receptacle and inlet	Hub size	Catalog number
60A	1¼"	JB6-B125
60A	1½"	JB6-B150
100A	1½"	JB10-B150
100A	2"	JB10-B200



Non-metallic backbox adapter

For receptacle and inlet	Catalog number
60A	BBA60
100A	BBA100



Metal backbox adapter

For receptacle and inlet	Catalog number
20-30A	MBA3060*
60A	MBA60
100A	MBA100

*Connects to 60A 20° angle adapter and enclosure



Tough & Safe | Food and Beverage Product Overview

IP69 testing proves that our IP&S products are perfect in food and beverage applications.

For food and beverage applications with high demands on cleaning, it can be hard to find plugs and receptacles that can withstand the high pressure, high temperature spray downs and chemical detergents used to keep the environment up to industry sanitation standards. ABB IEC-60309 Pin & Sleeve devices have been around for years and have a proven history of use in these in these toughest of environments.

IP69 testing certifies our products resist high pressure and high temperature spray downs.

The connectors and receptacles from our Tough & Safe range and the heavy-duty mechanical interlocks from the Critical & Safe range have passed third party testing for IP69. They fulfill the IP69 requirements both as stand-alone and while mated with our Tough & Safe plugs or inlets. IP69 (formerly IP69K) means that the products withstand close-range high pressure and high temperature spray downs. IP69 is a common requirement across most food and beverage applications, however there are very few manufacturers of industrial plugs and receptacles who can offer products that fulfil this requirement.

Designed for tough applications

Tough & Safe Food and Beverage range housings and cable clamps are made of Valox®. The use of this material offers excellent corrosion protection, carries a UL94 V0 rating, and highly impact resistant, which all adds up to a ruggedized solution.

A Complete Range with Safety in Mind

The Tough and Safe Food and Beverage range offers a complete range of plugs, connectors, receptacles, inlets and backboxes. With amperages ranging from 20 through 100, we offer a full range of voltages per the IEC 6-0309-2 standard. Our product offers a dual cable clamp design featuring both internal and external cable clamps. Additional features include two screws at each terminal to ensure safe and reliable cable connection, watertight sealing grommets and stainless-steel clamp screws. All of this adds up to a safe, reliable, rugged solution for your food and beverage application.



Tough & Safe | Food and Beverage

Ordering information

Tough and Safe Devices IP67



Amp	Poles and wires	Voltage (VAC*)	Clock hour	Plugs	Connectors	Receptacle	Inlet	Back Box
20	2P3W	277	5h	ABB320P5WN	ABB320C5WN	ABB320R5WN	ABB320B5WN	BB30N
16/20*	2P3W	200-250	6h	ABB316P6WN	ABB316C6WN	ABB316R6WN	ABB316B6WN	BB30N
20	2P3W	480	7h	ABB320P7WN	ABB320C7WN	ABB320R7WN	ABB320B7WN	BB30N
20	3P4W	3Ø 600	5h	ABB420P5WN	ABB420C5WN	ABB420R5WN	ABB420B5WN	BB30N
16/20*	3P4W	380-415	6h	ABB416P6WN	ABB416C6WN	ABB416R6WN	ABB416B6WN	BB30N
20	3P4W	3Ø 480	7h	ABB420P7WN	ABB420C7WN	ABB420R7WN	ABB420B7WN	BB30N
20	3P4W	3Ø 200-250	9h	ABB420P9WN	ABB420C9WN	ABB420R9WN	ABB420B9WN	BB30N
20	4P5W	3ØY 347/600	5h	ABB520P5WN	ABB520C5WN	ABB520R5WN	ABB520B5WN	BB30N
16/20*	4P5W	200/346-240/415	6h	ABB516P6WN	ABB516C6WN	ABB516R6WN	ABB516B6WN	BB30N
20	4P5W	3ØY 277/480	7h	ABB520P7WN	ABB520C7WN	ABB520R7WN	ABB520B7WN	BB30N
20	4P5W	3ØY 120/208-144/250	9h	ABB520P9WN	ABB520C9WN	ABB520R9WN	ABB520B9WN	BB30N
30	2P3W	277	5h	ABB330P5WN	ABB330C5WN	ABB330R5WN	ABB330B5WN	BB30N
30/32*	2P3W	200-250	6h	ABB332P6WN	ABB332C6WN	ABB332R6WN	ABB332B6WN	BB30N
30	2P3W	480	7h	ABB330P7WN	ABB330C7WN	ABB330R7WN	ABB330B7WN	BB30N
30	3P4W	3Ø 600	5h	ABB430P5WN	ABB430C5WN	ABB430R5WN	ABB430B5WN	BB30N
30/32*	3P4W	380-415	6h	ABB432P6WN	ABB432C6WN	ABB432R6WN	ABB432B6WN	BB30N
30	3P4W	3Ø 480	7h	ABB430P7WN	ABB430C7WN	ABB430R7WN	ABB430B7WN	BB30N
30	3P4W	3Ø 200-250	9h	ABB430P9WN	ABB430C9WN	ABB430R9WN	ABB430B9WN	BB30N
30	4P5W	3ØY 347/600	5h	ABB530P5WN	ABB530C5WN	ABB530R5WN	ABB530B5WN	BB30N
30/32*	4P5W	200/346-240/415	6h	ABB532P6WN	ABB532C6WN	ABB532R6WN	ABB532B6WN	BB30N
30	4P5W	3ØY 277/480	7h	ABB530P7WN	ABB530C7WN	ABB530R7WN	ABB530B7WN	BB30N
30	4P5W	3ØY 120/208-144/250	9h	ABB530P9WN	ABB530C9WN	ABB530R9WN	ABB530B9WN	BB30N
60	2P3W	277	5h	ABB360P5WN	ABB360C5WN	ABB360R5WN	ABB360B5WN	BB60N
60/63*	2P3W	200-250	6h	ABB363P6WN	ABB363C6WN	ABB363R6WN	ABB363B6WN	BB30N
60	2P3W	480	7h	ABB360P7WN	ABB360C7WN	ABB360R7WN	ABB360B7WN	BB30N
60	3P4W	3Ø 600	5h	ABB460P5WN	ABB460C5WN	ABB460R5WN	ABB460B5WN	BB30N
60/63*	3P4W	380-415	6h	ABB463P6WN	ABB463C6WN	ABB463R6WN	ABB463B6WN	BB30N
60	3P4W	3Ø 480	7h	ABB460P7WN	ABB460C7WN	ABB460R7WN	ABB460B7WN	BB30N
60	3P4W	3Ø 200-250	9h	ABB460P9WN	ABB460C9WN	ABB460R9WN	ABB460B9WN	BB30N
60	4P5W	3ØY 347/600	5h	ABB560P5WN	ABB560C5WN	ABB560R5WN	ABB560B5WN	BB30N
60/63*	4P5W	200/346-240/415	6h	ABB563P6WN	ABB563C6WN	ABB563R6WN	ABB563B6WN	BB30N
60	4P5W	3ØY 277/480	7h	ABB560P7WN	ABB560C7WN	ABB560R7WN	ABB560B7WN	BB30N
60	4P5W	3ØY 120/208-144/250	9h	ABB560P9WN	ABB560C9WN	ABB560R9WN	ABB560B9WN	BB30N
100	2P3W	277	5h	ABB3100P5WN	ABB3100C5WN	ABB3100R5WN	ABB3100B5WN	BB100N
100/125*	2P3W	200-250	6h	ABB3125P6WN	ABB3125C6WN	ABB3125R6WN	ABB3125B6WN	BB100N
100	2P3W	480	7h	ABB3100P7WN	ABB3100C7WN	ABB3100R7WN	ABB3100B7WN	BB100N
100	3P4W	3Ø 600	5h	ABB4100P5WN	ABB4100C5WN	ABB4100R5WN	ABB4100B5WN	BB100N
100/125*	3P4W	380-415	6h	ABB4125P6WN	ABB4125C6WN	ABB4125R6WN	ABB4125B6WN	BB100N
100	3P4W	3Ø 480	7h	ABB4100P7WN	ABB4100C7WN	ABB4100R7WN	ABB4100B7WN	BB100N
100	3P4W	3Ø 200-250	9h	ABB4100P9WN	ABB4100C9WN	ABB4100R9WN	ABB4100B9WN	BB100N
100	4P5W	3ØY 347/600	5h	ABB5100P5WN	ABB5100C5WN	ABB5100R5WN	ABB5100B5WN	BB100N
100/125*	4P5W	200/346-240/415	6h	ABB5125P6WN	ABB5125C6WN	ABB5125R6WN	ABB5125B6WN	BB100N
100	4P5W	3ØY 277/480	7h	ABB5100P7WN	ABB5100C7WN	ABB5100R7WN	ABB5100B7WN	BB100N
100	4P5W	3ØY 120/208-144/250	9h	ABB5100P9WN	ABB5100C9WN	ABB5100R9WN	ABB5100B9WN	BB100N

UL, CSA, NSF approved and CE compliant

* 16/20 - 30/32 - 60/63 - 100/125: Dual Certification



Critical & Safe

Product Overview and Features

Critical and safe product range are mechanically interlocked receptacles. They are used to provide additional safety.

Critical & Safe product range is perfect for applications with frequent connections and disconnections.

The interlocks are designed to prevent disconnecting a plug until the switch is turned off and turning the switch to the on position when a plug is not properly connected. Hence it offers an additional level of safety for personnel and equipment.

Furthermore, the interlocks are housed in Valox® that withstand most corrosion due to most chemicals and abuse from an industrial setting.

Features

- IP67 Watertight or IP44 Splashproof
- 20-100A, 50-600 VAC
- UL and CSA
- All external screws are made of stainless steel

Application examples

- Heavy/chemical industry
- Sawmills
- Airports
- Hospitals

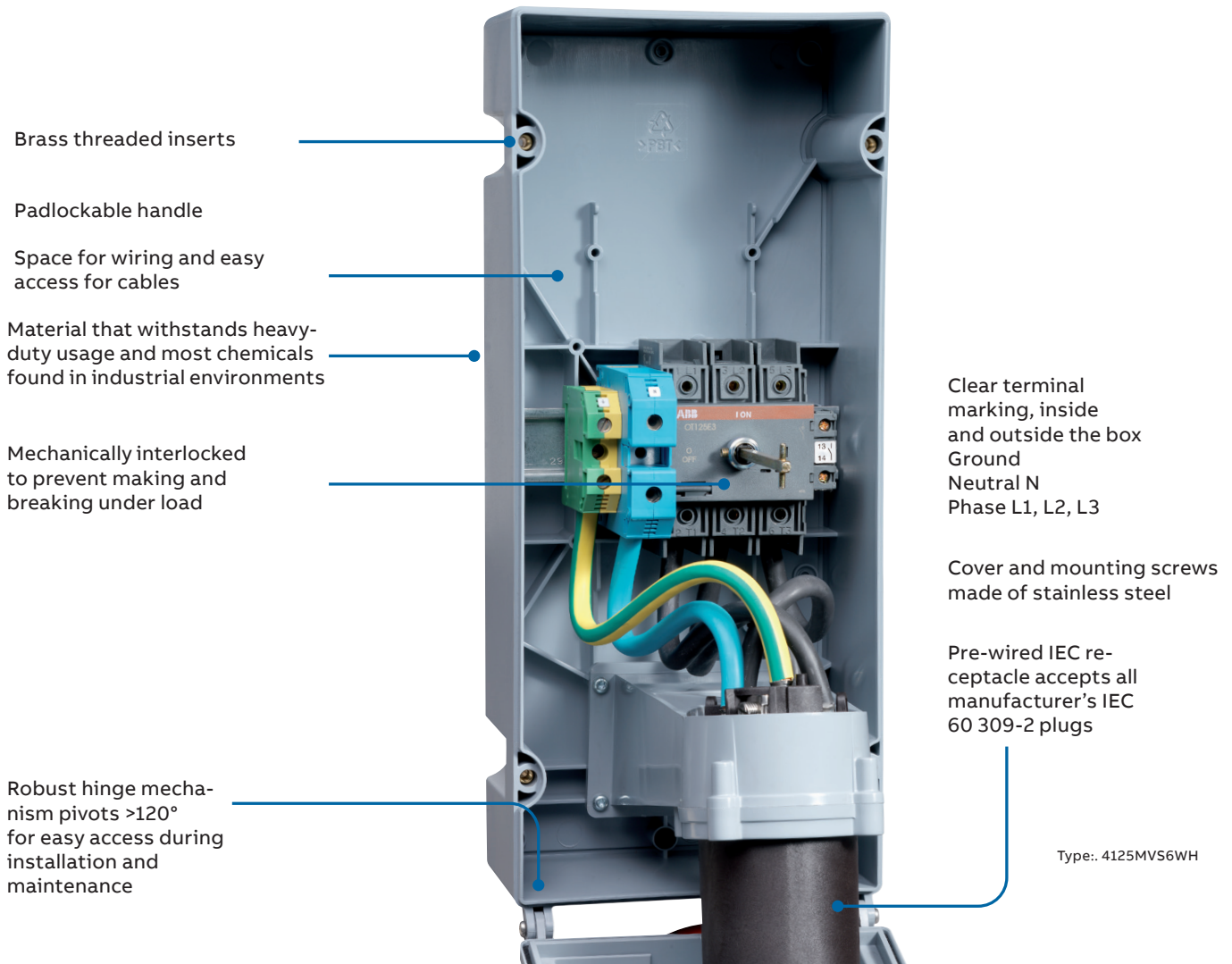

Brass threaded inserts

Padlockable handle

Space for wiring and easy access for cables

Material that withstands heavy-duty usage and most chemicals found in industrial environments

Mechanically interlocked to prevent making and breaking under load

Robust hinge mechanism pivots $>120^\circ$ for easy access during installation and maintenance

Clear terminal marking, inside and outside the box
Ground
Neutral N
Phase L1, L2, L3

Cover and mounting screws made of stainless steel

Pre-wired IEC receptacle accepts all manufacturer's IEC 60 309-2 plugs

Type: 4125MVS6WH



Critical & Safe IP67 - NSF

Ordering information



Critical and
Safe Devices
IP67/NSF

Amp	Poles and wires	Voltage (VAC*)	Clock hour	Switched interlocked outlet	Mating plug
20	2P3W	277	5h	ABB320MI5WN	ABB320P5WN
16/20*	2P3W	200-250	6h	ABB316MI6WN	ABB316P6WN
20	2P3W	480	7h	ABB320MI7WN	ABB320P7WN
20	3P4W	3Ø 600	5h	ABB420MI5WN	ABB420P5WN
16/20*	3P4W	380-415	6h	ABB416MI6WN	ABB416P6WN
20	3P4W	3Ø 480	7h	ABB420MI7WN	ABB420P7WN
20	3P4W	3Ø 200-250	9h	ABB420MI9WN	ABB420P9WN
20	4P5W	3ØY 347/600	5h	ABB520MI5WN	ABB520P5WN
16/20*	4P5W	200/346-240/415	6h	ABB516MI6WN	ABB516P6WN
20	4P5W	3ØY 277/480	7h	ABB520MI7WN	ABB520P7WN
20	4P5W	3ØY 120/208-144/250	9h	ABB520MI9WN	ABB520P9WN
30	2P3W	277	5h	ABB330MI5WN	ABB330P5WN
30/32*	2P3W	200-250	6h	ABB332MI6WN	ABB332P6WN
30	2P3W	480	7h	ABB330MI7WN	ABB330P7WN
30	3P4W	3Ø 600	5h	ABB430MI5WN	ABB430P5WN
30/32*	3P4W	380-415	6h	ABB432MI6WN	ABB432P6WN
30	3P4W	3Ø 480	7h	ABB430MI7WN	ABB430P7WN
30	3P4W	3Ø 200-250	9h	ABB430MI9WN	ABB430P9WN
30	4P5W	3ØY 347/600	5h	ABB530MI5WN	ABB530P5WN
30/32*	4P5W	200/346-240/415	6h	ABB532MI6WN	ABB532P6WN
30	4P5W	3ØY 277/480	7h	ABB530MI7WN	ABB530P7WN
30	4P5W	3ØY 120/208-144/250	9h	ABB530MI9WN	ABB530P9WN
60	2P3W	277	5h	ABB360MI5WN	ABB360P5WN
60/63*	2P3W	200-250	6h	ABB363MI6WN	ABB363P6WN
60	2P3W	480	7h	ABB360MI7WN	ABB360P7WN
60	3P4W	3Ø 600	5h	ABB460MI5WN	ABB460P5WN
60/63*	3P4W	380-415	6h	ABB463MI6WN	ABB463P6WN
60	3P4W	3Ø 480	7h	ABB460MI7WN	ABB460P7WN
60	3P4W	3Ø 200-250	9h	ABB460MI9WN	ABB460P9WN
60	4P5W	3ØY 347/600	5h	ABB560MI5WN	ABB560P5WN
60/63*	4P5W	200/346-240/415	6h	ABB563MI6WN	ABB563P6WN
60	4P5W	3ØY 277/480	7h	ABB560MI7WN	ABB560P7WN
60	4P5W	3ØY 120/208-144/250	9h	ABB560MI9WN	ABB560P9WN
100	2P3W	277	5h	ABB3100MI5WN	ABB3100P5WN
100/125*	2P3W	200-250	6h	ABB3125MI6WN	ABB3125P6WN
100	2P3W	480	7h	ABB3100MI7WN	ABB3100P7WN
100	3P4W	3Ø 600	5h	ABB4100MI5WN	ABB4100P5WN
100/125*	3P4W	380-415	6h	ABB4125MI6WN	ABB4125P6WN
100	3P4W	3Ø 480	7h	ABB4100MI7WN	ABB4100P7WN
100	3P4W	3Ø 200-250	9h	ABB4100MI9WN	ABB4100P9WN
100	4P5W	3ØY 347/600	5h	ABB5100MI5WN	ABB5100P5WN
100/125*	4P5W	200/346-240/415	6h	ABB5125MI6WN	ABB5125P6WN
100	4P5W	3ØY 277/480	7h	ABB5100MI7WN	ABB5100P7WN
100	4P5W	3ØY 120/208-144/250	9h	ABB5100MI9WN	ABB5100P9WN

* 16/20 - 30/32 - 60/63 - 100/125: Dual Certification

Critical & Safe IP67 - NSF

Ordering information



Critical
and Safe
Devices
IP67



Amp	Poles and wires	Voltage (VAC*)	Clock hour	Switch.Interlock. Broken	Switch.Interlock. Fused	Mating plug
16/20*	2P3W	200-250	6h			ABB316P6W
20	2P3W	480	7h			ABB320P7W
20	3P4W	3Ø 600	5h		ABB420MF5W	ABB420P5W
16/20*	3P4W	380-415	6h			ABB416P6W
20	3P4W	3Ø 480	7h		ABB420MF7W	ABB420P7W
20	3P4W	3Ø 200-250	9h		ABB420MF9W	ABB420P9W
20	3P4W	125/250	12h		ABB420MF12W	ABB420P12W
20	4P5W	3ØY 347/600	5h			ABB520P5W
16/20*	4P5W	200/346-240/415	6h			ABB516P6W
20	4P5W	3ØY 277/480	7h			ABB520P7W
20	4P5W	3ØY 120/208-144/250	9h			ABB520P9W
30	2P3W	277	5h			ABB330P5W
30/32*	2P3W	200-250	6h			ABB332P6W
30	2P3W	480	7h			ABB330P7W
30	3P4W	3Ø 600	5h		ABB430MF5W	ABB430P5W
30/32*	3P4W	380-415	6h			ABB432P6W
30	3P4W	3Ø 480	7h		ABB430MF7W	ABB430P7W
30	3P4W	3Ø 200-250	9h		ABB430MF9W	ABB430P9W
30	3P4W	125/250	12h		ABB430MF12W	ABB430P9W
30	4P5W	3ØY 347/600	5h		ABB530MF5W	ABB530P5W
30/32*	4P5W	200/346-240/415	6h			ABB532P6W
30	4P5W	3ØY 277/480	7h		ABB530MF7W	ABB530P7W
30	4P5W	3ØY 120/208-144/250	9h			ABB530P9W
60	2P3W	277	5h			ABB360P5W
60/63*	2P3W	200-250	6h		ABB363MF6W	ABB363P6W
60	2P3W	480	7h			ABB360P7W
60	3P4W	3Ø 600	5h		ABB460MF5W	ABB460P5W
60/63*	3P4W	380-415	6h			ABB463P6W
60	3P4W	3Ø 480	7h		ABB460MF7W	ABB460P7W
60	3P4W	3Ø 200-250	9h		ABB460MF9W	ABB460P9W
60	3P4W	125/250	12h		ABB460MF12W	ABB460P12W
60	4P5W	3ØY 347/600	5h			ABB560P5W
60/63*	4P5W	200/346-240/415	6h			ABB563P6W
60	4P5W	3ØY 277/480	7h			ABB560P7W
60	4P5W	3ØY 120/208-144/250	9h		ABB560MF9W	ABB560P9W
100	2P3W	277	5h			ABB3100P5W
100/125*	2P3W	200-250	6h			ABB3125P6W
100	2P3W	480	7h			ABB3100P7W
100	3P4W	3Ø 600	5h			ABB4100P5W
100/125*	3P4W	380-415	6h			ABB4125P6W
100	3P4W	3Ø 480	7h	ABB4100MB7W		ABB4100P7W
100	3P4W	3Ø 200-250	9h	ABB4100MB9W		ABB4100P9W
100	3P4W	125/250	12h	ABB4100MB12W		ABB4100P12W
100	4P5W	3ØY 347/600	5h			ABB5100P5W
100/125*	4P5W	200/346-240/415	6h			ABB5125P6W
100	4P5W	3ØY 277/480	7h	ABB5100MB7W		ABB5100P7W
100	4P5W	3ØY 120/208-144/250	9h	ABB5100MB9W		ABB5100P9W

* 16/20 - 30/32 - 60/63 - 100/125: Dual Certification

Critical & Safe IP67 - NSF | Food and Beverage Product Overview

Perfect for food and beverage applications

The heavy-duty mechanical interlocks from the

Critical & Safe range have received third party certification for IP69. Our IP&S can fulfill the IP69 requirements both as stand-alone device, as well as while mated with our Critical & Safe plugs. Our products withstand the rigorous close-range high pressure and high temperature spray downs prevalent in food and beverage applications. Critical and Safe also utilizes laser print product marking to ensure legibility of technical parameters.

When Safety Is Not an Option

Critical and Safe products for Food and Beverage applications are designed to prevent accidental disconnection. Utilizing a switch mechanism, users must turn the switch off to safely disconnect the devices. As well, the switch will not turn on without the proper connector being mated into the disconnect. This design provides an additional level of safety for applications that are used in public areas.

A Complete Range: Critical and Safe

The Critical and Safe Food and Beverage range offers a diverse range of plugs and switched interlocked outlets in amperages ranging from 20 through 125. Our voltages are specified per the IEC 60309-2 standard, ranging from 50 through 600 VAC. Our plugs offer a dual cable clamp design featuring both internal and external cable clamps. Our interlock is prewired with IEC receptacles, and accepts all approved IEC 60309-2 plugs.

Designed for Tough Applications

Critical & Safe Food and Beverage range housings and cable clamps are made of Valox®. The use of this material offers excellent corrosion protection, carries a UL94 V0 rating, and highly impact resistant, which all adds up to a ruggedized solution. In addition, the series offers a padlockable handle to provide an increased level of safety and protection.

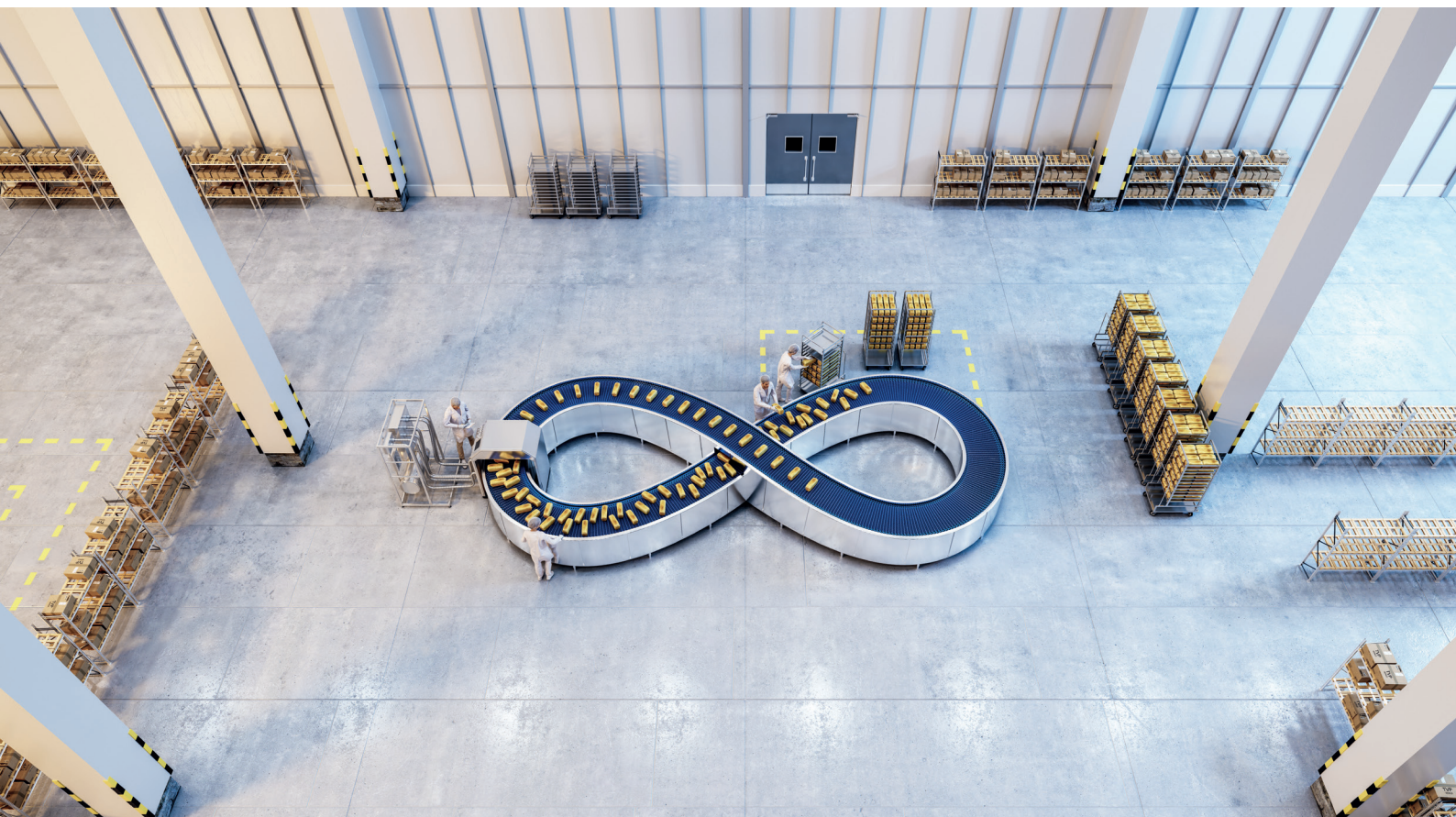

Critical & Safe IP67 - NSF | Food and Beverage

Ordering information

Critical and
Safe
Devices
IP67/NSF



Amp	Poles and wires	Voltage (VAC*)	Clock hour	Switched interlocked outlet	Mating plug
20	2P3W	277	5h	ABB320MI5WN	ABB320P5WN
16/20*	2P3W	200-250	6h	ABB316MI6WN	ABB316P6WN
20	2P3W	480	7h	ABB320MI7WN	ABB320P7WN
20	3P4W	3Ø 600	5h	ABB420MI5WN	ABB420P5WN
16/20*	3P4W	380-415	6h	ABB416MI6WN	ABB416P6WN
20	3P4W	3Ø 480	7h	ABB420MI7WN	ABB420P7WN
20	3P4W	3Ø 200-250	9h	ABB420MI9WN	ABB420P9WN
20	4P5W	3ØY 347/600	5h	ABB520MI5WN	ABB520P5WN
16/20*	4P5W	200/346-240/415	6h	ABB516MI6WN	ABB516P6WN
20	4P5W	3ØY 277/480	7h	ABB520MI7WN	ABB520P7WN
20	4P5W	3ØY 120/208-144/250	9h	ABB520MI9WN	ABB520P9WN
30	2P3W	277	5h	ABB330MI5WN	ABB330P5WN
30/32*	2P3W	200-250	6h	ABB332MI6WN	ABB332P6WN
30	2P3W	480	7h	ABB330MI7WN	ABB330P7WN
30	3P4W	3Ø 600	5h	ABB430MI5WN	ABB430P5WN
30/32*	3P4W	380-415	6h	ABB432MI6WN	ABB432P6WN
30	3P4W	3Ø 480	7h	ABB430MI7WN	ABB430P7WN
30	3P4W	3Ø 200-250	9h	ABB430MI9WN	ABB430P9WN
30	4P5W	3ØY 347/600	5h	ABB530MI5WN	ABB530P5WN
30/32*	4P5W	200/346-240/415	6h	ABB532MI6WN	ABB532P6WN
30	4P5W	3ØY 277/480	7h	ABB530MI7WN	ABB530P7WN
30	4P5W	3ØY 120/208-144/250	9h	ABB530MI9WN	ABB530P9WN
60	2P3W	277	5h	ABB360MI5WN	ABB360P5WN
60/63*	2P3W	200-250	6h	ABB363MI6WN	ABB363P6WN
60	2P3W	480	7h	ABB360MI7WN	ABB360P7WN
60	3P4W	3Ø 600	5h	ABB460MI5WN	ABB460P5WN
60/63*	3P4W	380-415	6h	ABB463MI6WN	ABB463P6WN
60	3P4W	3Ø 480	7h	ABB460MI7WN	ABB460P7WN
60	3P4W	3Ø 200-250	9h	ABB460MI9WN	ABB460P9WN
60	4P5W	3ØY 347/600	5h	ABB560MI5WN	ABB560P5WN
60/63*	4P5W	200/346-240/415	6h	ABB563MI6WN	ABB563P6WN
60	4P5W	3ØY 277/480	7h	ABB560MI7WN	ABB560P7WN
60	4P5W	3ØY 120/208-144/250	9h	ABB560MI9WN	ABB560P9WN
100	2P3W	277	5h	ABB3100MI5WN	ABB3100P5WN
100/125*	2P3W	200-250	6h	ABB3125MI6WN	ABB3125P6WN
100	2P3W	480	7h	ABB3100MI7WN	ABB3100P7WN
100	3P4W	3Ø 600	5h	ABB4100MI5WN	ABB4100P5WN
100/125*	3P4W	380-415	6h	ABB4125MI6WN	ABB4125P6WN
100	3P4W	3Ø 480	7h	ABB4100MI7WN	ABB4100P7WN
100	3P4W	3Ø 200-250	9h	ABB4100MI9WN	ABB4100P9WN
100	4P5W	3ØY 347/600	5h	ABB5100MI5WN	ABB5100P5WN
100/125*	4P5W	200/346-240/415	6h	ABB5125MI6WN	ABB5125P6WN
100	4P5W	3ØY 277/480	7h	ABB5100MI7WN	ABB5100P7WN
100	4P5W	3ØY 120/208-144/250	9h	ABB5100MI9WN	ABB5100P9WN

* 16/20 - 30/32 - 60/63 - 100/125: Dual Certification

Technical specifications

Easy & Safe

20A-30A, IP44 and IP67

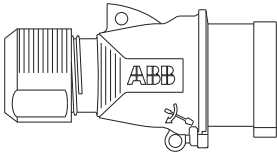

Plug 20A-30A IP44

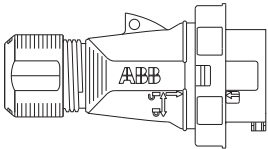

Plug 20A-30A IP67

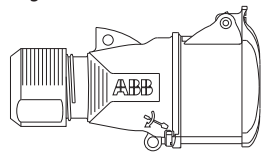

Connector 20A-30A IP44

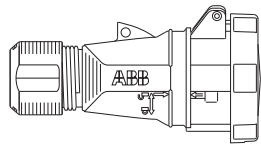

Connector 20A-30A IP67

Wire sizes

Tightening nut lbs	Terminal screws lbs	Wire size Inches	Cable area	AWG
44.2	30.9	0.66-1.29	6 - 16 mm ²	10-14

Tightening guide

Device	Terminal screws in.lbs.	Assembly screws in.lbs.	Cable gland torque in.lbs.	Cable dimension range Inches
320	7.08	1.06	35.4 - 53.1	0.31 - 0.51
420	7.08	1.06	35.4 - 53.1	0.51 - 0.66
520	7.08	1.06	35.4 - 53.1	0.51 - 0.66
330	1.06	1.06	35.4 - 53.1	0.51 - 0.84
430	1.06	1.06	35.4 - 53.1	0.51 - 0.84
530	1.06	1.06	35.4 - 53.1	0.51 - 0.84



Technical specifications

Tough & Safe

20A-100A IP67

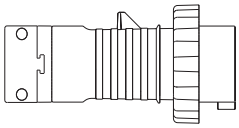

20A-30A Plug

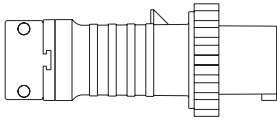

60A-100A Plug

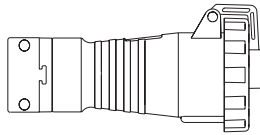

20A-30A Connector

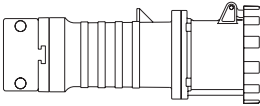

60A-100A Connector

Tightening guide

Device	Terminal screws in.lbs.	Internal cable clamp screws (in .lbs./nm)	External cable clamp screws (in. lbs./nm)	Assembly screws (in.lbs./nm)
20A	7.1/0.8	10.6/1.2	17.7/2.0	10.6/1.2
30A	10.6/1.2	10.6/1.2	17.7/2.0	10.6/1.2
60A	31/3.5	10.6/1.5	26.6/3.0	10.6/1.2
100A	50/5.6	17.7/2.0	26.6/3.0	17.7/2.0

Wire sizes

Device	Cable dimension range (in./mm)	AWG
20A (16A)	.350/.860/9-22	14-12
20A (16A)	.350/.860/9-22	14-12
20A (16A)	.437/1.187/11-30	14-12
30A (32A)	.437/1.187/11-30	12-10
30A (32A)	.437/1.187/11-30	12-10
30A (32A)	.437/1.450/11-37	12-10
60A (63A)	.670/1.625/17-41	8-4
60A (63A)	.670/1.625/17-41	8-4
60A (63A)	.670/1.625/17-41	8-4
100A (125A)	.950/1.875/24-48	3-1
100A (125A)	.950/1.875/24-48	3-1
100A (125A)	.950/1.875/24-48	3-1

Technical specifications

Tough & Safe | Food and Beverage

20A-100A IP67 NSF

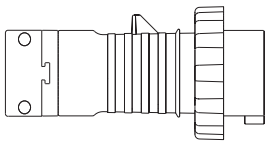

20A-30A Plug

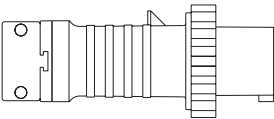

60A-100A Plug

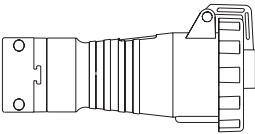

20A-30A Connector

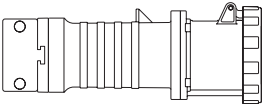

60A-100A Connector

Tightening guide

Device	Terminal screws in.lbs.	Internal cable clamp screws (in .lbs./nm)	External cable clamp screws (in. lbs./nm)	Assembly screws (in.lbs./nm)
20A	7.1/0.8	10.6/1.2	17.7/2.0	10.6/1.2
30A	10.6/1.2	10.6/1.2	17.7/2.0	10.6/1.2
60A	31/3.5	10.6/1.5	26.6/3.0	10.6/1.2
100A	50/5.6	17.7/2.0	26.6/3.0	17.7/2.0

Wire sizes

Device	Cable dimension range (in./mm)	AWG
20A (16A)	.350/.860/9-22	14-12
20A (16A)	.350/.860/9-22	14-12
20A (16A)	.437/1.187/11-30	14-12
30A (32A)	.437/1.187/11-30	12-10
30A (32A)	.437/1.187/11-30	12-10
30A (32A)	.437/1.450/11-37	12-10
60A (63A)	.670/1.625/17-41	8-4
60A (63A)	.670/1.625/17-41	8-4
60A (63A)	.670/1.625/17-41	8-4
100A (125A)	.950/1.875/24-48	3-1
100A (125A)	.950/1.875/24-48	3-1
100A (125A)	.950/1.875/24-48	3-1

Technical specifications

Critical & Safe

IP67 Mechanical interlock

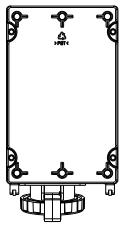
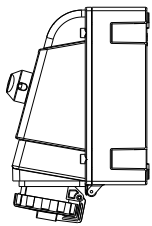
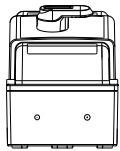
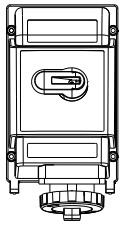

**Pin and Sleeve Mechanical Interlock
Receptacles in Watertight Enclosures**
Type MI, 20A, 30A, 60A & 100A (Non-Fused)
Type MF, 20A, 30A, & 60A (Fused)
Type MB, 100A (Breakered)

Tightening guide

Device	Terminal screws in.lbs.	Assembly screws (in.lbs./nm)
20A	7.1/0.8	10.6/1.2
30A	10.6/1.2	10.6/1.2
60A	31/3.5	10.6/1.2
100A	50/5.6	17.7/2.0

Wire sizes

Device	Cable dimension range (in./mm)	AWG
20A (16A)	.350/.860/9-22	14-12
20A (16A)	.350/.860/9-22	14-12
20A (16A)	.437/1.187/11-30	14-12
30A (32A)	.437/1.187/11-30	12-10
30A (32A)	.437/1.187/11-30	12-10
30A (32A)	.437/1.450/11-37	12-10
60A (63A)	.670/1.625/17-41	8-4
60A (63A)	.670/1.625/17-41	8-4
60A (63A)	.670/1.625/17-41	8-4
100A (125A)	.950/1.875/24-48	3-1
100A (125A)	.950/1.875/24-48	3-1
100A (125A)	.950/1.875/24-48	3-1

Technical specifications

Critical & Safe | Food and Beverage

IP67 Mechanical interlock, NSF

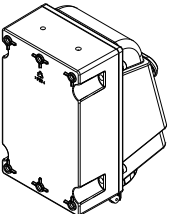
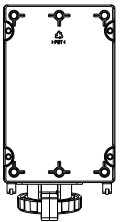
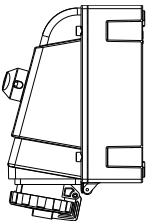
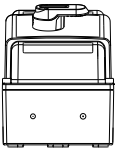
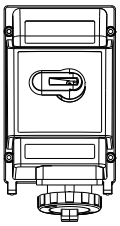

**Pin and Sleeve Mechanical Interlock
Receptacles in Watertight Enclosures**
 Type MI, 20A, 30A, 60A & 100A (Non-Fused)
 Type MF, 20A, 30A, & 60A (Fused)
 Type MB, 100A (Breakered)

Tightening guide

Device	Terminal screws in.lbs.	Assembly screws (in.lbs./nm)
20A	7.1/0.8	10.6/1.2
30A	10.6/1.2	10.6/1.2
60A	31/3.5	10.6/1.2
100A	50/5.6	17.7/2.0

Wire sizes

Device	Cable dimension range (in./mm)	AWG
20A (16A)	.350/.860/9-22	14-12
20A (16A)	.350/.860/9-22	14-12
20A (16A)	.437/1.187/11-30	14-12
30A (32A)	.437/1.187/11-30	12-10
30A (32A)	.437/1.187/11-30	12-10
30A (32A)	.437/1.450/11-37	12-10
60A (63A)	.670/1.625/17-41	8-4
60A (63A)	.670/1.625/17-41	8-4
60A (63A)	.670/1.625/17-41	8-4
100A (125A)	.950/1.875/24-48	3-1
100A (125A)	.950/1.875/24-48	3-1
100A (125A)	.950/1.875/24-48	3-1



Approximate dimensions

Easy & Safe

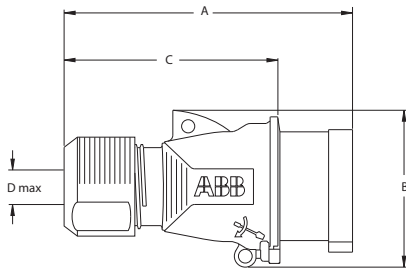

**20A-30A
Plug IP44**

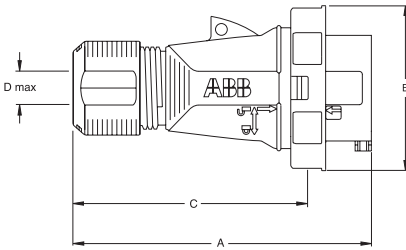

**20A-30A
Plug IP67**

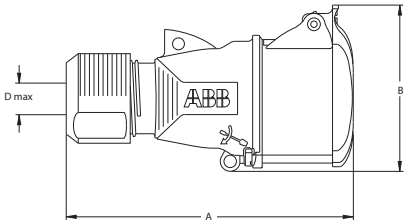

**20A-30A
Connector IP44**

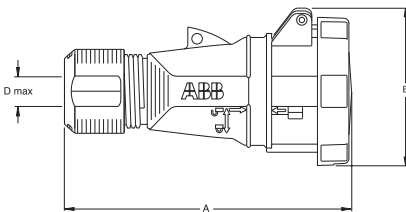

**20A-30A
Connector IP67**

Plugs

Type	A	B	C	Dmax
320P...SP	127	62.5	88.5	14
420P...SP	144	74.5	106	17
520P...SP	144	78	106	17

Type	A	B	C	Dmax
330P...SP	167	82.5	121	22
430P...SP	167	82.5	121	22
530P...SP	167	82.5	121	22

Connectors

Type	A	B	Dmax
320C...SP	135.5	74.5	14
420C...SP	155	87	17
520C...SP	156	90.5	17

Type	A	B	Dmax
330C...SP	182	93.5	22
430C...SP	182	93.5	22
530C...SP	182.5	99	22

Type	A	B	Dmax
320C...E	146	81	14
420C...E	169	88	17
520C...E	169	92	17

Type	A	B	Dmax
330C...E	195	98	22
430C...E	195	98	22
530C...E	195	104	22

Approximate dimensions

Tough & Safe

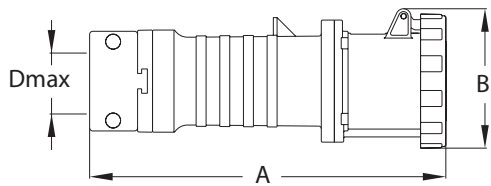
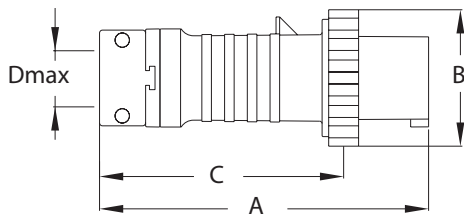
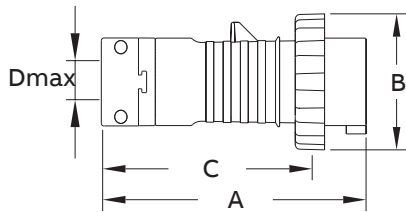

Plugs

Type	A (in./mm)	B (in./mm)	C (in./mm)	Dmax (in./mm)
20A, 2P3W	5.81/147.5	2.80/71	4.47/113.5	0.51/13
20A, 3P4W	6.46/164	3.11/79	5.16/131	0.67/17
20A, 4P5W	6.61/168	3.43/87	5.28/134	0.67/17
30A, 2P3W	6.85/174	3.70/94	4.74/120.5	0.85/21.5
30A, 3P4W	6.85/174	3.70/94	5.41/137.5	0.85/21.5
30A, 4P5W	7.40/188	3.98/101	5.47/139	0.85/21.5
60A, All	10.83/275	4.49/114	8.39/213	1.61/41
100, All	12.32/313	5.12/130	9.53/242	1.89/48

Connectors

Type	A (in./mm)	B (in./mm)	Dmax (in./mm)
20A, 2P3W	6.73/171	3.15/80	0.51/13
20A, 3P4W	7.40/188	3.46/88	0.67/17
20A, 4P5W	7.68/195	3.82/97	0.67/17
30A, 2P3W	7.76/197	3.94/100	0.85/21.5
30A, 3P4W	7.76/197	3.94/100	0.85/21.5
30A, 4P5W	8.27/210	4.29/109	0.85/21.5
60A, All	11.26/286	4.37/111	1.61/41
100A, All	12.80/325	4.80/122	1.89/48



Approximate dimensions

Tough & Safe

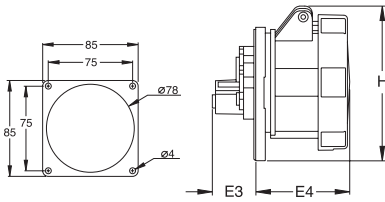

20A-30A

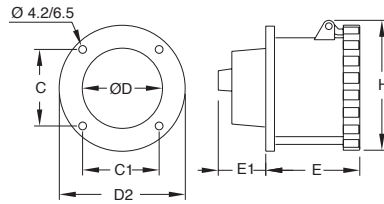

60A

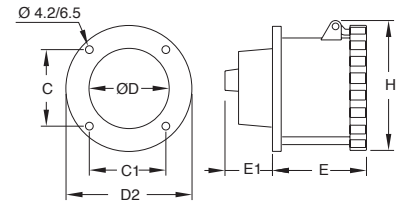

100A

Receptacles

Type	C (in./mm)	C1 (in./mm)	D (in./mm)	D2 (in./mm)	E (in./mm)	E1 (in./mm)	H (in./mm)
20A, 2P3W	3.13/79.5	3.13/79.5	3.27/83	3.74/95	1.77/45	2.24/57	3.74/95
20A, 3P4W	3.13/79.5	3.13/79.5	3.27/83	3.74/95	1.77/45	2.24/57	3.74/95
20A, 4P5W	3.13/79.5	3.13/79.5	3.27/83	3.74/95	1.85/47	2.24/57	3.90/99
30A, 2P3W	3.13/79.5	3.13/79.5	3.27/83	3.74/95	2.20/56	2.40/61	4.09/104
30A, 3P4W	3.13/79.5	3.13/79.5	3.27/83	3.74/95	2.20/56	2.40/61	4.09/104
30A, 4P5W	3.13/79.5	3.13/79.5	3.27/83	3.74/95	2.20/56	2.44/62	4.37/111
60A, All	2.40/61	2.40/61	2.76/70	4.09/104	3.50/89	1.89/48	4.37/111
100A, All	2.80/71	2.80/71	3.46/88	4.53/115	3.94/100	2.28/58	4.80/122

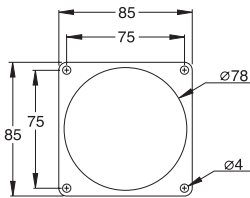

20A-30A

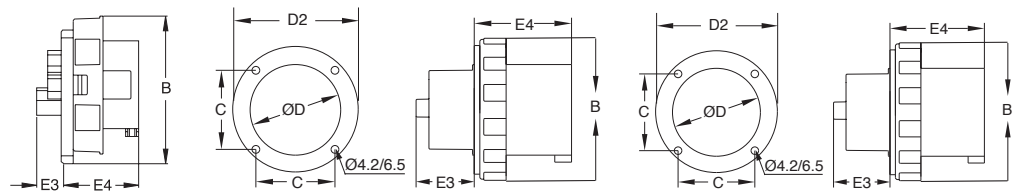

100A

60A

Inlets

Type	C (in./mm)	D (in./mm)	D2 (in./mm)	E3 (in./mm)	E4 (in./mm)	F (in./mm)
20A, 2P3W	3.13/79.5	3.27/83	3.74/95	0.40/10	1.85/47	2.80/71
20A, 3P4W	3.13/79.5	3.27/83	3.74/95	0.40/10	2.09/53	3.11/79
20A, 4P5W	3.13/79.5	3.27/83	3.74/95	0.40/10	3.43/87	3.43/87
30A, 2P3W	3.13/79.5	3.27/83	3.74/95	0.47/12	2.36/60	3.70/94
30A, 3P4W	3.13/79.5	3.27/83	3.74/95	0.47/12	2.36/60	3.70/94
30A, 4P5W	3.13/79.5	3.27/83	3.74/95	0.47/12	2.64/67	3.98/101
60A, All	4.41/112	2.40/61	2.76/70	3.86/98	1.97/50	3.15/80
100A, All	4.80/122	2.80/71	3.19/81	4.65/118	2.20/56	3.50/89

Approximate dimensions

Tough & Safe | Food and Beverage

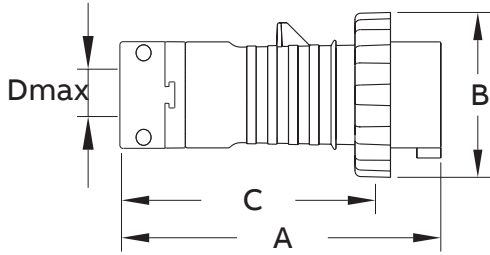

20A-30A

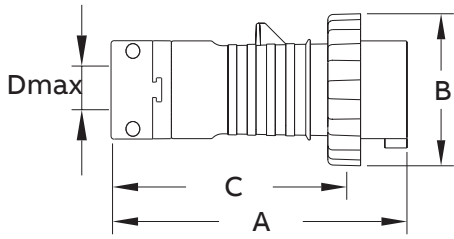

60A-100A

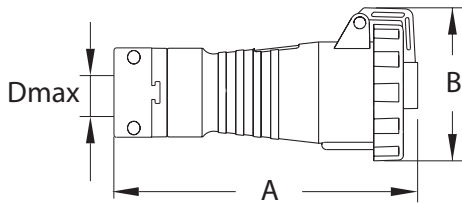

20A-30A

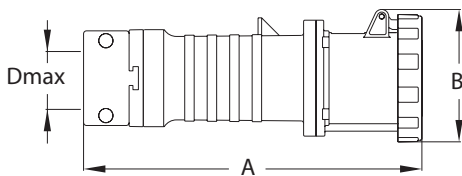

60A-100A

Plugs

Type	A (in./mm)	B (in./mm)	C (in./mm)	Dmax (in./mm)
20A, 2P3W	5.81/147.5	2.80/71	4.47/113.5	0.51/13
20A, 3P4W	6.46/164	3.11/79	5.16/131	0.67/17
20A, 4P5W	6.61/168	3.43/87	5.28/134	0.67/17
30A, 2P3W	6.85/174	3.70/94	4.74/120.5	0.85/21.5
30A, 3P4W	6.85/174	3.70/94	5.41/137.5	0.85/21.5
30A, 4P5W	7.40/188	3.98/101	5.47/139	0.85/21.5
60A, All	10.83/275	4.49/114	8.39/213	1.61/41
100, All	12.32/313	5.12/130	9.53/242	1.89/48

Connectors

Type	A (in./mm)	B (in./mm)	Dmax (in./mm)
20A, 2P3W	6.73/171	3.15/80	0.51/13
20A, 3P4W	7.40/188	3.46/88	0.67/17
20A, 4P5W	7.68/195	3.82/97	0.67/17
30A, 2P3W	7.76/197	3.94/100	0.85/21.5
30A, 3P4W	7.76/197	3.94/100	0.85/21.5
30A, 4P5W	8.27/210	4.29/109	0.85/21.5
60A, All	11.26/286	4.37/111	1.61/41
100A, All	12.80/325	4.80/122	1.89/48



Approximate dimensions

Tough & Safe | Food and Beverage

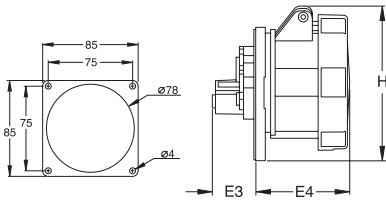

20A-30A

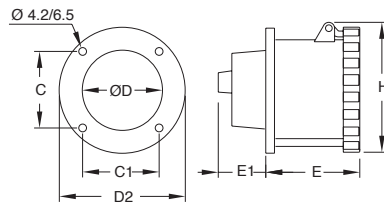

60A

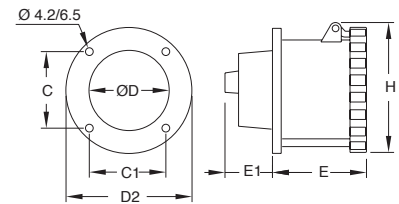

100A

Receptacles

Type	C (in./mm)	C1 (in./mm)	D (in./mm)	D2 (in./mm)	E (in./mm)	E1 (in./mm)	H (in./mm)
20A, 2P3W	3.13/79.5	3.13/79.5	3.27/83	3.74/95	1.77/45	2.24/57	3.74/95
20A, 3P4W	3.13/79.5	3.13/79.5	3.27/83	3.74/95	1.77/45	2.24/57	3.74/95
20A, 4P5W	3.13/79.5	3.13/79.5	3.27/83	3.74/95	1.85/47	2.24/57	3.90/99
30A, 2P3W	3.13/79.5	3.13/79.5	3.27/83	3.74/95	2.20/56	2.40/61	4.09/104
30A, 3P4W	3.13/79.5	3.13/79.5	3.27/83	3.74/95	2.20/56	2.40/61	4.09/104
30A, 4P5W	3.13/79.5	3.13/79.5	3.27/83	3.74/95	2.20/56	2.44/62	4.37/111
60A, All	2.40/61	2.40/61	2.76/70	4.09/104	3.50/89	1.89/48	4.37/111
100A, All	2.80/71	2.80/71	3.46/88	4.53/115	3.94/100	2.28/58	4.80/122

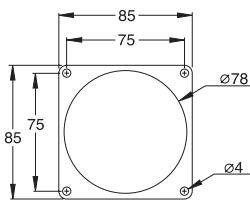

20A-30A

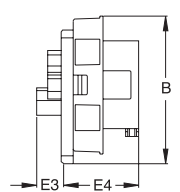

100A

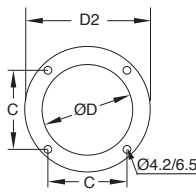

60A

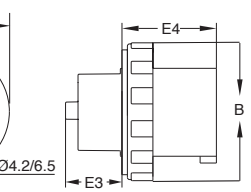
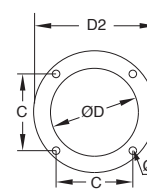
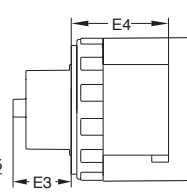

Inlets

Type	C (in./mm)	D (in./mm)	D2 (in./mm)	E3 (in./mm)	E4 (in./mm)	F (in./mm)
20A, 2P3W	3.13/79.5	3.27/83	3.74/95	0.40/10	1.85/47	2.80/71
20A, 3P4W	3.13/79.5	3.27/83	3.74/95	0.40/10	2.09/53	3.11/79
20A, 4P5W	3.13/79.5	3.27/83	3.74/95	0.40/10	3.43/87	3.43/87
30A, 2P3W	3.13/79.5	3.27/83	3.74/95	0.47/12	2.36/60	3.70/94
30A, 3P4W	3.13/79.5	3.27/83	3.74/95	0.47/12	2.36/60	3.70/94
30A, 4P5W	3.13/79.5	3.27/83	3.74/95	0.47/12	2.64/67	3.98/101
60A, All	4.41/112	2.40/61	2.76/70	3.86/98	1.97/50	3.15/80
100A, All	4.80/122	2.80/71	3.19/81	4.65/118	2.20/56	3.50/89

Approximate dimensions

Critical & Safe

Mechanical Interlock

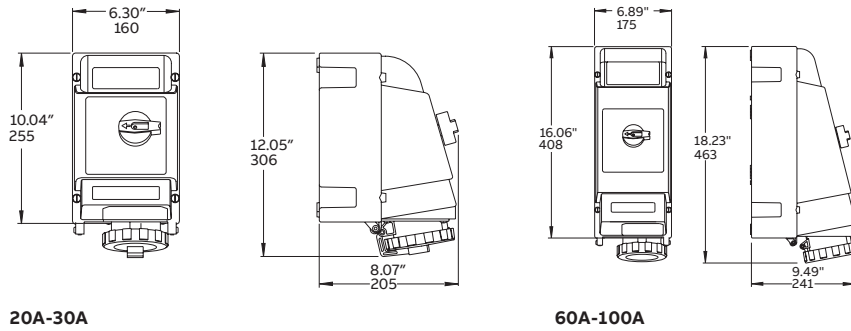

20A-30A

60A-100A

Approximate dimensions

Critical & Safe | Food and Beverage

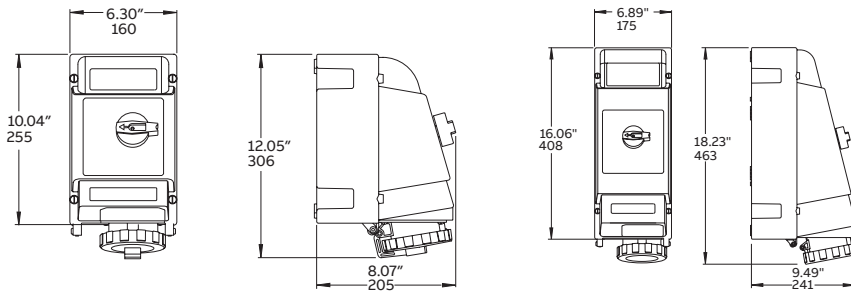

20A-30A

60A-100A



Technical Characteristics

Easy & Safe

Performance—Electrical	
Dielectric voltage withstand	3000 volts for 1 minute (devices > 300V) 2000 volts for 1 minute (devices ≤ 300V)
Maximum working voltage	600VAC/250VDC (minimum creepage and clearances per UL 840)
Current interrupting/ load breaking	Tested to 150% of full rated current for circuit interrupting
Temperature rise	Maximum 30 °C rise at full rated current after 50 cycles overload at 150% rated load at .75 pF
Endurance with load Per IEC 60 309-1 clause 21	20 amp: 5000 cycles—Rated current, voltage 30 amp: 1000 cycles—Rated current, voltage 60 amp: 1000 cycles—Rated current, voltage 100 amp: 250 cycles—Rated current, voltage

Performance—Mechanical	
Cold (-25 °C) impact resistance	Per UL 1682 Section 34 and IEC 60 309-1 Clause 24
Cable O.D. accommodation	Round portable service cord from .57" O.D. through 1.79" O.D.
Terminal identification	In accordance with UL 1682 standards and IEC 60 309-1: as L1-L2- L3-N-G
Cable pull-out force	Per UL 1682 Section 33 and IEC 60 309-1 Clause 23
Product identification	Product trademark(s) and UL approved product label

Performance—Environmental	
Moisture resistance	Splashproof IP44 to watertight IP67
Flammability	All components V2 for internal parts & V0 for external parts on 20A & 30A devices per UL94 or CSA 22.2 No. 0.6; V0 on 60A and 10 0A
Operating temperatures	-25 °C/-13 °F minimum to 40 °C/ 1 04 ° F maximum for continuous operations and up to 70 °C/1 58 °F for intermittent operation
Chemical resistance	Resists standard industrial hydrocarbons, acids, bases, and solvents
Corrosion resistance	All metallic components stainless steel or brass sleeve pressure spring of stainless steel
UV resistance	In accordance with UL 746C f1

Materials	
Housing	Polyamide 6
Contact carriers	Polyamide 6
Cable clamps	Polyamide 6
Cable tightening nut	TPE 40 shore
Pins and sleeves	Brass
Sleeve force ring	Stainless steel
Terminal screws	Zinc-plated steel
Flap/screw cover springs	Stainless steel
Mounting flanges	Polyamide 6

Approvals and compliances	
1682, 1686 E109667 E109550 E163435	
60 309-1, -2, -4 LVD 2014/35/EC EMC 2014/30/EC	
C22.2 No. 182.1 LR 51334	

Technical Characteristics

Tough & Safe

Performance—Electrical

Dielectric voltage withstand	3000 volts for 1 minute (devices > 300V) 2000 volts for 1 minute (devices ≤ 300V)
Maximum working voltage	600VAC/250VDC (minimum creepage and clearances per UL 840)
Current interrupting/ load breaking	Tested to 150% of full rated current for circuit interrupting
Temperature rise	Maximum 30 °C rise at full rated current after 50 cycles overload at 150% rated load at .75 pF
Endurance with load Per IEC 60 309-1 clause 21	20 amp: 5000 cycles—Rated current, voltage 30 amp: 1000 cycles—Rated current, voltage 60 amp: 1000 cycles—Rated current, voltage 100 amp: 250 cycles—Rated current, voltage

Performance—Mechanical

Cold (-25 °C) impact resistance	Per UL 1682 Section 34 and IEC 60 309-1 Clause 24
Cable O.D. accommodation	Round portable service cord from .57" O.D. through 1.79" O.D.
Terminal identification	In accordance with UL 1682 standards and IEC 60 309-1: as L1-L2- L3-N-G
Cable pull-out force	Per UL 1682 Section 33 and IEC 60 309-1 Clause 23
Product identification	Product trademark(s) and UL approved product label



Performance—Environmental

Moisture resistance	Watertight to IP67 and IP69K
Flammability	All components V2 for internal parts & V0 for external parts on 20A & 30A devices per UL94 or CSA 22.2 No. 0.6; V0 on 60A and 100A
Operating temperatures	-55 °C/-67 °F minimum to 55 °C/131 °F maximum for continuous operations and up to 70 °C/158 °F for intermittent operation
Chemical resistance	Resists standard industrial hydrocarbons, acids, bases, and solvents
Corrosion resistance	All metallic components stainless steel or brass sleeve pressure spring of stainless steel
UV resistance	In accordance with UL 746C f1

Materials

Housing	Valox®
Contact carriers	Polyamide nylon (Fiberglass reinforced for 60A to 125A)
Cable clamps	Valox®
Cable bushing	Chloroprene, onion-ring type
O-Ring, seals and gaskets	Solid chloroprene
Pins and sleeves	Brass
Sleeve force ring	Stainless steel
Terminal screws	Zinc-plated steel
Flap/screw cover springs	Stainless steel
Mounting flanges	Valox®

Approvals and compliances

1682, 1686 E109667 E109550 E163435	
60 309-1, -2, -4 LVD 2014/35/EC EMC 2014/30/EC	
C22.2 No. 182.1 LR 51334	



Technical Characteristics

Tough & Safe | Food and Beverage

Performance—Electrical	
Dielectric voltage withstand	3000 volts for 1 minute (devices > 300V) 2000 volts for 1 minute (devices ≤ 300V)
Maximum working voltage	600VAC/250VDC (minimum creepage and clearances per UL 840)
Current interrupting/ load breaking	Tested to 150% of full rated current for circuit interrupting
Temperature rise	Maximum 30 °C rise at full rated current after 50 cycles overload at 150% rated load at .75 pF
Endurance with load Per IEC 60 309-1 clause 21	20 amp: 5000 cycles—Rated current, voltage 30 amp: 1000 cycles—Rated current, voltage 60 amp: 1000 cycles—Rated current, voltage 100 amp: 250 cycles—Rated current, voltage

Performance—Mechanical	
Cold (-25 °C) impact resistance	Per UL 1682 Section 34 and IEC 60 309-1 Clause 24
Cable O.D. accommodation	Round portable service cord from .57" O.D. through 1.79" O.D.
Terminal identification	In accordance with UL 1682 standards and IEC 60 309-1: as L1-L2-L3-N-G
Cable pull-out force	Per UL 1682 Section 33 and IEC 60 309-1 Clause 23
Product identification	Product trademark(s) and UL approved product label

Performance—Environmental	
Moisture resistance	Watertight to IP67 and IP69K
Flammability	All components V2 for internal parts & V0 for external parts on 20A & 30A devices per UL94 or CSA 22.2 No. 0.6; V0 on 60A and 100A
Operating temperatures	-55 °C/-67 °F minimum to 55 °C/131 °F maximum for continuous operations and up to 70 °C/158 °F for intermittent operation
Chemical resistance	Resists standard industrial hydrocarbons, acids, bases, and solvents
Corrosion resistance	All metallic components stainless steel or brass sleeve pressure spring of stainless steel
UV resistance	In accordance with UL 746C f1

Materials	
Housing	Valox®
Contact carriers	Polyamide nylon (Fiberglass reinforced for 60A to 125A)
Cable clamps	Valox®
Cable bushing	Chloroprene, onion-ring type
O-Ring, seals and gaskets	Solid chloroprene
Pins and sleeves	Brass
Sleeve force ring	Stainless steel
Terminal screws	Zinc-plated steel
Flap/screw cover springs	Stainless steel
Mounting flanges	Valox®

Approvals and compliances	
1682, 1686 E109667 E109550 E163435	
60 309-1, -2, -4 LVD 2014/35/EC EMC 2014/30/EC	
C22.2 No. 182.1 LR 51334	
NSF/ANSI Standard 169	



Technical Characteristics

Critical & Safe

Performance—Electrical

Dielectric voltage withstand	3000 volts
Maximum working voltage	480 volts RMS (circuit breaker version) 600 volts RMS (switch version)
Current interrupting	Certified for current interrupting at full rated current and voltage
Short-circuit current rating operations	10,000 RMS symmetrical amperes Mechanical: 10,000 cycles Electrical: 6000 cycles
HP ratings (switch version)	Complies with NEC® 430–151 ratings
Circuit breaker UL listed interrupting rating	22,000 AIC

Performance—Mechanical

Cold (-25 °C) impact resistance	In accordance with UL® 746C
Wiring accommodations	Suitable for metallic conduit. Conduit entry locations at enclosure top and bottom
Terminal identification	In accordance with UL, CSA and IEC 60 309 conventions
Product identification	Identification, ratings and color code in accordance with UL, CSA and IEC 60 309 requirements
Lockout/tagout	“ON” and “OFF” lockout/tagout capability at switch handle. Complies with OSHA Reg. 29CFR 1910.147
Mounting	External adjustable feet

Performance—Environmental

Moisture resistance	Screw cap version: UL Type 4X and 12K, IP67 and IP69K
Flammability	UL 94-5VA and V0 classifications
Operating temperatures	Maximum continuous: 60 °C (140 °F) Minimum continuous: -40 °C (-40 °F)
UV resistance	UV-stabilized material in accordance with UL 746C f1
Chemicals	UV-stabilized material in accordance with UL 746C f1

Materials

Enclosure (all exterior components)	UL 94-5VA/V0, UV-stabilized, impact-modified Valox®
Contact carrier	Polyamide nylon (Fiberglass reinforced for 60A to 125A devices)
Gaskets	Chloroprene or EPDM
Contacts (sleeves)	Brass
Hardware (screws and springs)	Steel with zinc-plated blue chromate or nickel plating

Approvals and compliances

UL 508 and UL 98 (switch version) UL 231 and UL 489 (circuit breaker version) UL 1682, 1686	
IEC 60 309-1, -2, -4	
CSA C22.2 No. 14, 182.1	



Technical Characteristics



Critical & Safe | Food and Beverage

Performance—Electrical	
Dielectric voltage withstand	3000 volts
Maximum working voltage	480 volts RMS (circuit breaker version) 600 volts RMS (switch version)
Current interrupting	Certified for current interrupting at full rated current and voltage
Short-circuit current rating operations	10,000 RMS symmetrical amperes Mechanical: 10,000 cycles Electrical: 6000 cycles
HP ratings (switch version)	Complies with NEC® 430–151 ratings
Circuit breaker UL listed interrupting rating	22,000 AIC

Performance—Mechanical	
Cold (-25 °C) impact resistance	In accordance with UL® 746C
Wiring accommodations	Suitable for metallic conduit. Conduit entry locations at enclosure top and bottom
Terminal identification	In accordance with UL, CSA and IEC 60 309 conventions
Product identification	Identification, ratings and color code in accordance with UL, CSA and IEC 60 309 requirements
Lockout/tagout	“ON” and “OFF” lockout/tagout capability at switch handle. Complies with OSHA Reg. 29CFR 1910.147
Mounting	External adjustable feet

Performance—Environmental	
Moisture resistance	Screw cap version: UL Type 4X and 12K, IP67 and IP69K
Flammability	UL 94-5VA and V0 classifications
Operating temperatures	Maximum continuous: 60 °C (140 °F) Minimum continuous: -40 °C (-40 °F)
UV resistance	UV-stabilized material in accordance with UL 746C f1
Chemicals	UV-stabilized material in accordance with UL 746C f1

Materials	
Enclosure (all exterior components)	UL 94-5VA/V0, UV-stabilized, impact-modified Valox®
Contact carrier	Polyamide nylon (Fiberglass reinforced for 60A to 125A devices)
Gaskets	Chloroprene or EPDM
Contacts (sleeves)	Brass
Hardware (screws and springs)	Steel with zinc-plated blue chromate or nickel plating

Approvals and compliances	
UL 508 and UL 98 (switch version) UL 231 and UL 489 (circuit breaker version) UL 1682, 1686	
IEC 60 309-1, -2, -4	
CSA C22.2 No. 14, 182.1	
NSF/ANSI Standard 169	