

Product Range Overview

Sub-Series Name	USB Type A	USB Type B	Micro USB Swift	Micro USB Swift-MU
Mating Style	Screw Thread & 2 Points Lock	Screw Thread & 2 Points Lock	-	Snap-in
Plastic Version	✓	✓	-	✓
Metal Version	✓	✓	✓	-
Plating of Contacts	Gold Plated	Gold Plated	Gold Plated	Gold Plated
Transmission Rate	USB 2.0 USB 3.2 Gen 1	USB 2.0 USB 3.2 Gen 1	USB 2.0	USB 2.0
Operating Voltage (AC/DC)	30V	30V	30V AC 5V DC	30V AC 5V DC
Nominal Current	USB 2.0: 1.5A USB 3.2 Gen 1: 1A	USB 2.0: 1.5A	1 & 5 Pin: 1.8A 2, 3 & 4 Pin: 1A	1 & 5 Pin: 1.8A 2, 3 & 4 Pin: 1A
Operating Temperature	Receptacle: Nylon+GF: -40°C ~ 105°C M-PPE: -40°C ~ 105°C ABS: -40°C ~ 105°C Receptacle With Cable: Nylon+GF: -20°C ~ 85°C ABS: -20°C ~ 85°C Overmolded, Field Serviceable/Installable: -20°C ~ 85°C		-30°C~80°C SMD: 260°C / 5sec	-40°C~80°C
Fasten Style	Front	Front	-	-
Receptacle	✓	✓	✓	-
Overmolded Receptacle	✓	✓	-	-
Overmolded Cable	✓	✓	-	✓
Field Serviceable/Installable	✓	✓	-	-
Applicable Wire Gauge	28AWG*1P + 24AWG*2C (0.08mm ²) + (0.25mm ²)		-	28AWG (0.08mm ²)
Mating Cycles (Pin Contact)	1,500 Cycles	1,500 Cycles	10,000 Cycles	10,000 Cycles
IP Rating	Receptacle, Receptacle With Cable: IP68 (Unmated) Overmolded With Cable, Field Serviceable/Installable: IP67 (Mated)		IP67 (Unmated, 1M / 30mins) IP68 (Unmated, 1M / 24h) IP68 (Unmated, 5M / 24h) IP68 (Unmated, 10M / 3h)	IP67 (Mated)
Salt Spray (Connector, Mated)	48h	48h	48h	48h
Flammability	UL 94V-0	UL 94V-0	UL 94V-0	UL 94V-0
Vibration Resistant	Frequency Range 10 ~ 55Hz / Amplitude 1.52mm			
EMI Option	✓	✓	✓	✓
ROHS 2.0 Compliant	✓	✓	✓	✓
REACH Compliant	✓	✓	✓	✓
Accessories	✓	✓	-	-
Self-closing Cap	✓	✓	-	-

Product Range Overview





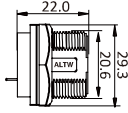
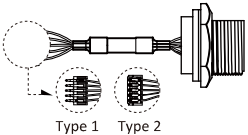
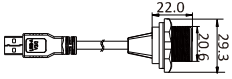
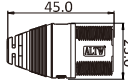
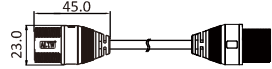
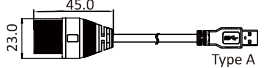
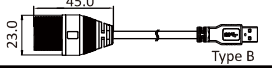
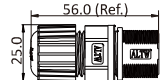
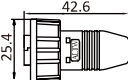
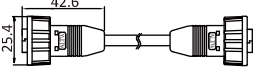
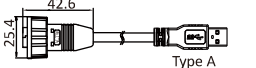
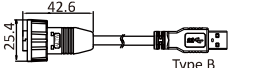













Sub-Series Name	Mini USB Type B	USB Type C Swift-LP	USB Type C Swift-LA	USB Type C Swift-GG	USB Type C Swift-XL
Mating Style	Screw Thread	-	Snap-in	Screw Thread	Push Lock
Plastic Version	✓	-	✓	✓	✓
Metal Version	-	✓	-	✓	-
Plating of Contacts	Gold Plated	Gold Plated	Gold Plated	Gold Plated	Gold Plated
Transmission Rate	USB 2.0	USB 3.2 Gen 2	USB 2.0 USB 3.2 Gen 1	USB 3.2 Gen 1 / Gen 2	USB 3.2 Gen 1
Operating Voltage (AC/DC)	30V	30V DC	30V DC	30V DC	30V DC
Nominal Current	USB 2.0: 1.5A	Up To 5A	Up To 3A	Up To 5A	Up To 3A
Operating Temperature	Receptacle: Nylon+GF: -40°C ~ 105°C M-PPE: -40°C ~ 105°C ABS: -40°C ~ 105°C Receptacle With Cable: Nylon+GF: -20°C ~ 85°C ABS: -20°C ~ 85°C Overmolded, Field Serviceable/Installable: -20°C ~ 85°C	-40°C ~ 85°C SMD: 260°C / 5sec	Receptacle: -40°C ~ 85°C Overmolded: -20°C ~ 80°C	Overmolded: -20°C ~ 85°C	
Fasten Style	Front	-	-	Front	-
Receptacle	✓	✓	✓	✓	-
Overmolded Receptacle	✓	-	-	-	-
Overmolded Cable	✓	-	✓	✓	✓
Field Serviceable/Installable	✓	-	-	-	-
Applicable Wire Gauge	28AWG*1P + 28AWG*3C (0.08mm ²)	-	32AWG*1P + 24AWG*1C + 28AWG*1D (0.03mm ²) + (0.25mm ²) + (0.08mm ²)		
Mating Cycles (Pin Contact)	5,000 Cycles	10,000 Cycles	10,000 Cycles	10,000 Cycles	10,000 Cycles
IP Rating	Receptacle, Receptacle With Cable: IP68 (Unmated) Overmolded With Cable, Field Serviceable/Installable: IP67 (Mated)	IP67 (Unmated) IP68 (Unmated)	Receptacle: IP68 (Unmated) Overmolded: IP67 (Mated)	Receptacle: IP67 (Unmated) Overmolded: IP67 (Mated)	IP68 (Mated, 1M / 24h)
Salt Spray (Connector, Mated)	48h	48h	48h	48h	48h
Flammability	UL 94VHB	UL 94V-0	UL 94V-0	UL 94V-0	UL 94V-0
Vibration Resistant	Frequency Range 10~55Hz / Amplitude 1.52mm				
EMI Option	✓	✓	✓	✓	✓
ROHS 2.0 Compliant	✓	✓	✓	✓	✓
REACH Compliant	✓	✓	✓	✓	✓
Accessories	✓	-	-	✓	✓
Self-closing Cap	-	-	-	-	-

Type A & B Screw Threaded (13/16"28 UNS)

Size	Middle Size				
Specification	Type A				
Rated Voltage (AC/DC)	30V				
Nominal Current	1.5A	1A	1.5A	1A	
Data Transfer Rate	2.0	3.2 Gen 1	2.0	3.2 Gen 1	
Plastic / Metal	Plastic			Metal	
Receptacle, Circular Flange, FRONT Fastened Nut, IP68 (Unmated) Connector/Contact Gender: Male Connector Female Contact Nut Torque Value: 3.5 ~ 5 kgf.cm Recommended Panel Thickness: with cap: 2.8mm, without cap: 4.0mm					
	Solder Type Without Cable	UA-20PMFS-SC8001*	-	USA-20PMFS-SC8001*	-
	180° PCB Type Without Cable	UA-20PMFP-SC8001	UA-30PMFP-SC8001*	USA-20PMFP-SC8001*	USA-30PMFP-SC8001*
	180° PCB Type (Type 1) With Wire And Housing (Press Fit Pin, Harness: 50mm)	UA-20PMFP-SC8002	UA-30PMFP-SC8002*	USA-20PMFP-SC8002*	USA-30PMFP-SC8002*
	180° PCB Type (Type 2) With Wire And Housing (Jack, Harness: 50mm)	UA-20PMFP-SC8003	UA-30PMFP-SC8003*	USA-20PMFP-SC8003*	USA-30PMFP-SC8003*
Receptacle with Cable, Circular Backshell, FRONT Fastened Nut, IP67 (Unmated) Connector/Contact Gender: Male Connector Female Contact With Plug ⑩ Cable Length: (15) 150mm ~ (30) 300mm					
	PVC Jacket Non-waterproof	UA-20PMFL-SC7A⑩*	UA-30PMFL-SC7B⑩	USA-20PMFL-SC7A⑩*	USA-30PMFL-SC7B⑩*
STRAIGHT , Overmolded Cable Assembly, Free Cable End, With Strain Relief, IP67 (Mated) Connector/Contact Gender: Male Connector Female Contact ⑩ Cable Length: USB 2.0: (01) 1M ~ (05) 5M, USB 3.2 Gen 1: (01) 1M ~ (03) 3M					
	PVC Jacket	UA-20AMFM-SL7A⑩	UA-30AMFM-SL7B⑩	USA-20AMFM-SL7A⑩*	USA-30AMFM-SL7B⑩*
STRAIGHT , Overmolded Double-Ended Cable Assembly Connector/Contact Gender: Male Connector Female Contact ⑩ Cable Length: USB 2.0: (A05) 0.5M ~ (005) 5M, USB 3.2 Gen 1: (A05) 0.5M ~ (003) 3M					
	PVC Jacket IP67 (Mated)	UA20ML-UAML-SA⑩*	UA30ML-UAML-SB⑩*	USA20ML-UAML-SA⑩*	USA30ML-USAML-SB⑩*
	PVC Jacket Non-waterproof Type A	UA20ML-NAML-SA⑩	UA30ML-NAML-SB⑩	USA20ML-NAML-SA⑩*	USA30ML-NAML-SB⑩*
	PVC Jacket Non-waterproof Type B	UA20ML-NBML-SA⑩	UA30ML-NBML-SB⑩*	USA20ML-NBML-SA⑩*	USA30ML-NBML-SB⑩*
Field Serviceable/Installable, STRAIGHT , Without Strain Relief, IP68 (Mated) Connector/Contact Gender: Male Connector Female Contact Sealing Nut Torque Value: 3.5 ~ 5 kgf.cm Recommended Cable O.D.: 5.0 ~ 10.8mm					
	Solder Type	UA-20BMFA-SL8001	UA-30BMFA-SL8001*	USA-20BMFA-SL8001*	USA-30BMFA-SL8001*
STRAIGHT , Overmolded Cable Assembly, Free Cable End, Without Strain Relief, IP67 (Mated) Connector/Contact Gender: Female Connector Male Contact ⑩ Cable Length: USB 2.0: (01) 1M ~ (05) 5M, USB 3.2 Gen 1: (01) 1M ~ (03) 3M					
	PVC Jacket	UA-20BFMM-SL7A⑩	UA-30BFMM-SL7B⑩	USA-20BFMM-SL7A⑩	USA-30BFMM-SL7B⑩*
STRAIGHT-TO-STRAIGHT , Overmolded Double-Ended Cable Assembly Connector/Contact Gender: Female Connector Male Contact ⑩ Cable Length: USB 2.0: (A05) 0.5M ~ (005) 5M, USB 3.2 Gen 1: (A05) 0.5M ~ (003) 3M					
	PVC Jacket IP67 (Mated)	UA20FL-UAFL-SA⑩	UA30FL-UAFL-SB⑩*	USA20FL-UAFL-SA⑩*	USA30FL-UAFL-SB⑩*
	PVC Jacket Non-waterproof Type A	UA20FL-NAML-SA⑩	UA30FL-NAML-SB⑩	USA20FL-NAML-SA⑩	USA30FL-NAML-SB⑩*
	PVC Jacket Non-waterproof Type B	UA20FL-NBML-SA⑩	UA30FL-NBML-SB⑩*	USA20FL-NBML-SA⑩*	USA30FL-NBML-SB⑩*

* Upon Request

Type A & B Screw Threaded (13/16"28 UNS)

Middle Size			
Type B			
30V			
1.5A	1A	1.5A	1A
2.0	3.2 Gen 1	2.0	3.2 Gen 1
Plastic		Metal	
UB-20PMFS-SC8001*	-	USB-20PMFS-SC8001*	-
UB-20PMFP-SC8001	UB-30PMFP-SC8001*	USB-20PMFP-SC8001*	USB-30PMFP-SC8001*
UB-20PMFP-SC8002	UB-30PMFP-SC8002*	USB-20PMFP-SC8002*	USB-30PMFP-SC8002*
UB-20PMFP-SC8003	USB-30PMFP-SC8003	USB-20PMFP-SC8003*	USB-30PMFP-SC8003*
-	-	-	-
UB-20AMFM-SL7A 	UB-30AMFM-SL7B 	USB-20AMFM-SL7A 	-
UB20ML-UBML-SA 	-	USB20ML-USBML-SA 	-
UB20ML-NAML-SA 	-	USB20ML-NAML-SA 	-
UB20ML-NBML-SA 	-	USB20ML-NBML-SA 	-
UB-20BMFA-SL8001	UB-30BMFA-SL8001*	USB-20BMFA-SL8001*	USB-30BMFA-SL8001*
UB-20BFMM-SL7A 	UB-30BFMM-SL7B 	USB-20BFMM-SL7A 	USB-30BFMM-SL7B 
UB20FL-UBFL-SA 	-	USB20FL-USBFL-SA 	-
UB20FL-NAML-SA 	-	USB20FL-NAML-SA 	-
UB20FL-NBML-SA 	-	USB20FL-NBML-SA 	-

Mating

Pair

Panel Cut Out

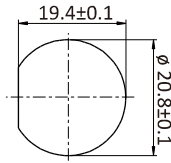

(Unit: mm)

Type A & B Lock Bayonet (2 Points)

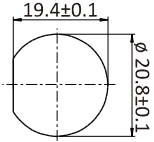
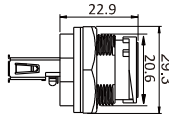
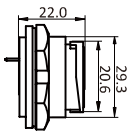
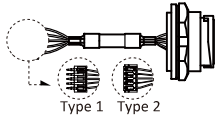
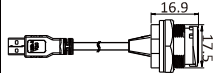
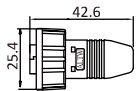
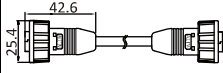
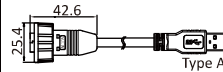
Size	Middle Size (Nut OD: 25.4mm)				
Specification	Panel Cut Out 	Type A			
Rated Voltage (AC/DC)		30V			
Nominal Current		1.5A	1A	1.5A	1A
Data Transfer Rate		2.0	3.2 Gen 1	2.0	3.2 Gen 1
Plastic / Metal		Plastic		Metal	
Receptacle, Circular Flange, FRONT Fastened Nut Connector/Contact Gender: Male Connector Female Contact Nut Torque Value: 3.5 ~ 5 kgf.cm Recommended Panel Thickness: with cap: 2.8mm, without cap: 4.0mm					
Jack, IP67 (Unmated) Without Cable		UA-20PMFJ-NC7001	UA-30PMFJ-NC7001*	USA-20PMFJ-NC7001*	USA-30PMFJ-NC7001*
Solder Type, Without Cable Middle: IP67 (Unmated) Large: IP68 (Unmated)		UA-20PMF5-NC7001*	-	USA-20PMF5-NC7001*	-
180° PCB Type, IP67 (Unmated)		UA-20PMFP-NC7001*	-	USA-20PMFP-NC7001*	-
180° PCB Type, IP67 (Unmated) (Type 1) With Wire And Housing (Press Fit Pin, Harness: 50mm)		UA-20PMFP-NC7002*	-	USA-20PMFP-NC7002*	-
180° PCB Type, IP67 (Unmated) (Type 2) With Wire And Housing (Jack, Harness: 50mm)		UA-20PMFP-NC7003*	-	USA-20PMFP-NC7003*	-
Receptacle with Cable, Circular Backshell, FRONT Fastened Nut, IP67 (Unmated) Male Connector Female Contact Cable Length: (15) 150mm ~ (30) 300mm Recommended Panel Thickness: (With Cap) 2.8mm, (Without Cap) 4.0mm					
PVC Jacket Non-waterproof		UA-20PMFL-NC7A 10*	UA-30PMFL-NC7B 10*	USA-20PMFL-NC7A 10*	USA-30PMFL-NC7B 10*
STRAIGHT, Overmolded Cable Assembly, Free Cable End, With Strain Relief, IP67 (Mated) Connector/Contact Gender: Female Connector Male Contact Middle Size: Without Strain Relief Large Size: With Strain Relief Cable Length: USB 2.0: (01) 1M ~ (05) 5M, USB 3.2 Gen 1: (01) 1M ~ (03) 3M					
PVC Jacket		UA-20BFMM-NL7A 10	UA-30BFMM-NL7B 10*	USA-20BFMM-NL7A 10*	USA-30BFMM-NL7B 10*
RIGHT ANGLE, Overmolded Cable Assembly, Free Cable End, IP67 (Mated) Connector/Contact Gender: Female Connector Male Contact Large Size: With Strain Relief Cable Length: USB 2.0: (01) 1M ~ (05) 5M, USB 3.2 Gen 1: (01) 1M ~ (03) 3M					
PVC Jacket	N/A	-	-	-	-
STRAIGHT-TO-STRAIGHT, Overmolded Double-Ended Cable Assembly Connector/Contact Gender: Female Connector Male Contact Cable Length: USB 2.0: (A05) 0.5M ~ (005) 5M, USB 3.2 Gen 1: (A05) 0.5M ~ (003) 3M					
PVC Jacket IP67 (Mated)		UA20FL-UAFL-NA 10*	-	USA20FL-USAFL-NA 10*	-
PVC Jacket Non-waterproof		UA20FL-NAML-NA 10*	-	USA20FL-NAML-NA 10*	-
RIGHT ANGLE-TO-STRAIGHT, Overmolded Double-Ended Cable Assembly Connector/Contact Gender: Female Connector Male Contact Cable Length: USB 2.0: (A05) 0.5M ~ (005) 5M, USB 3.2 Gen 1: (A05) 0.5M ~ (003) 3M					
PVC Jacket IP67 (Mated)	N/A	-	-	-	-
PVC Jacket Non-waterproof	N/A	-	-	-	-

* Upon Request

Type A & B Lock Bayonet (2 Points)

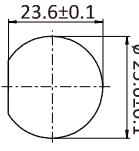
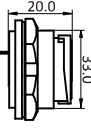
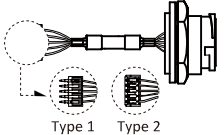
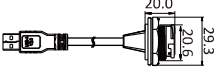
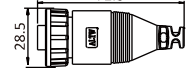
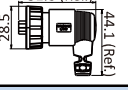
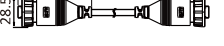
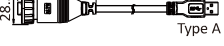
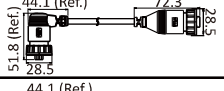
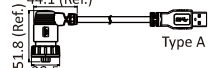

Large Size (Nut OD: 28.5mm)						
Panel Cut Out 	Type A				Type B	
	30V					
	1.5A	1A	1.5A	1A	1.5A	
	2.0	3.2 Gen 1	2.0	3.2 Gen 1	2.0	2.0
Plastic		Metal		Plastic	Metal	
N/A	-	-	-	-	-	-
	UA-20PMFS-LC8001*	-	USA-20PMFS-LC8001*	-	UB-20PMFS-LC7001*	USB-20PMFS-LC7001*
	UA-20PMFP-LC7001	-	USA-20PMFP-LC7001*	-	UB-20PMFP-LC7001	USB-20PMFP-LC7001*
	UA-20PMFP-LC7002	-	USA-20PMFP-LC7002*	-	UB-20PMFP-LC7002	USB-20PMFP-LC7002*
	UA-20PMFP-LC7003	-	USA-20PMFP-LC7003*	-	UB-20PMFP-LC7003	USB-20PMFP-LC7003*
	UA-20PMFL-LC7A 10*	UA-30PMFL-LC7B 10	USA-20PMFL-LC7A 10*	USA-30PMFL-LC7B 10*	-	-
	UA-20AFMM-LL7A 10	UA-30AFMM-LL7B 10	USA-20AFMM-LL7A 10*	USA-30AFMM-LL7B 10*	UB-20AFMM-LL7A 10	USB-20AFMM-LL7A 10*
	UA-20AFMM-LR7A 10	-	USA-20AFMM-LR7A 10*	-	UB-20AFMM-LR7A 10	USB-20AFMM-LR7A 10*
	UA20FL-UAFL-LA 10*	-	USA20FL-USAFL-LA 10*	-	UB20FL-UBFL-LA 10*	USB20FL-USBFL-LA 10*
	UA20FL-NAML-LA 10*	UA30FL-NAML-LB 10	USA20FL-NAML-LA 10*	USA30FL-NAML-LB 10*	UB20FL-NBML-LA 10*	USB20FL-NBML-LA 10*
	UA20FR-UAML-LA 10*	-	USA20FR-USAML-LA 10*	-	UB20FR-UBML-LA 10*	USB20FR-USBML-LA 10*
	UA20FR-NAML-LA 10*	-	USA20FR-NAML-LA 10*	-	UB20FR-NBML-LA 10*	USB20FR-NBML-LA 10*

Mating

Pair

(Unit: mm)

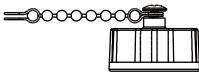
Waterproof Cap

   							
None		With Chain		With Rubber Lead		With Fish Line	
Size	Mating Pair	Mating Style	Gender of Mating Pair	Attachment	Part Number		
Middle Size (13/16"28 UNS)	Receptacle	Screw Thread	Male	With Chain	CAP-WACMSPB1		
	Receptacle & Overmolded with Cable		Male	With Rubber Lead	CAP-WACMSPC1		
	Overmolded with Cable		Male	None	CAP-WACMSMA1		
			Female	With Rubber Lead	CAP-WUSFSCC1		
			Female	With Chain	CAP-WUSFSCB1		
		Male	With Fish Line	CAP-WACMSPD1			
Middle Size	Receptacle	2 Points Lock	Male	With Chain	CAP - WACMLPB1*		
	Receptacle & Overmolded with Cable			With Rubber Lead	CAP - WACMLPC1*		
				None	CAP - WACMLMA1		
Large Size (1/20" UNEF)	Receptacle			With Chain	CAP-WADMLPB2		
	Receptacle & Overmolded with Cable			With Rubber Lead	CAP-WADMLPC2		
				None	CAP-WADMLMA2		

USB With Self-closing Cap (IP67 / 69K)

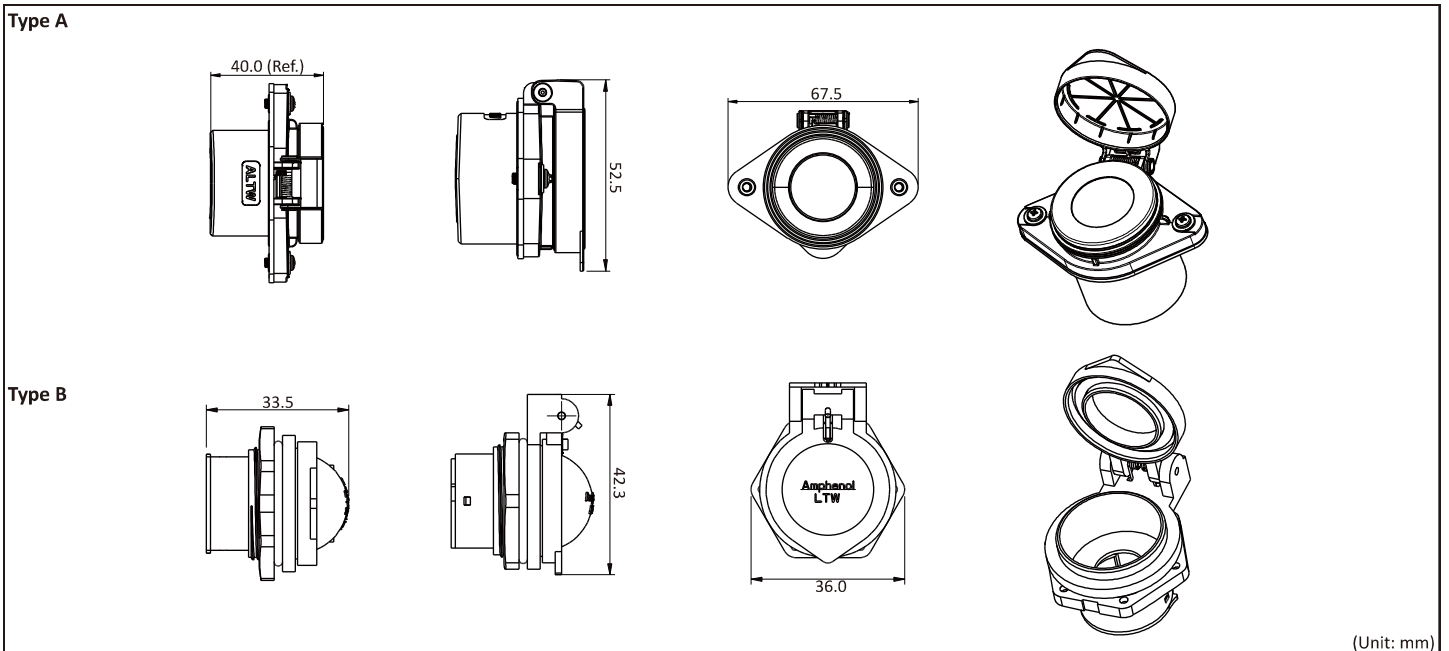

IP Rating	① Connector Style	② Transmission Speed	③ Port No.	Part Number
IP67	(A) Style A	(UA20) USB Type A 2.0	(S) Single	W ①-②-③ 7001*
		(UA30) USB Type A 3.2 Gen 1		
	(B) Style B	(UB20) USB Type B 2.0	(D) Dual	

Distribution Box

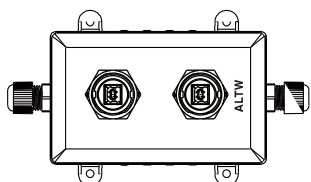

USB Type B 2.0*

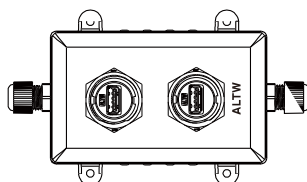

USB Type A 2.0*

*Upon Request

Mini USB Type B Screw Threaded

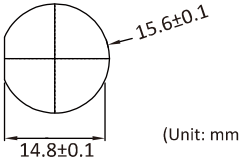
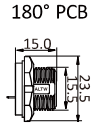
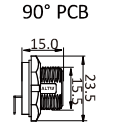
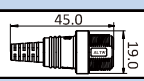
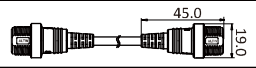
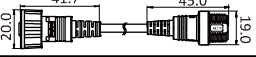
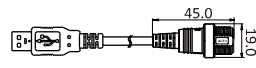
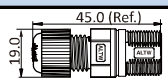
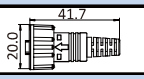
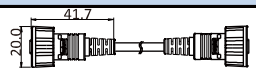
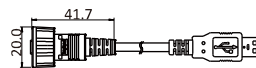
Specification	Panel Cut Out	Type A	Type B
Rated Voltage (AC/DC)		30V	
Nominal Current		1.5A	
Data Transfer Rate		2.0	
Plastic / Metal		Plastic	Plastic
Receptacle, Jack, FRONT Fastened Nut, IP67 (Unmated)		Nut Torque Value: 3.5 ~ 5 kgf.cm Recommended Panel Thickness: (With Cap) 1.3mm, (Without Cap) 2.5mm	
 	180° PCB Type Male Connector Female Contact	-	NUB-20PMFP-SC7001
	90° PCB Type Male Connector Female Contact	-	NUB-20PMFR-SC7001
STRAIGHT , Overmolded Cable Assembly, Free Cable End, With Strain Relief, IP67 (Mated)			
⑩ Cable Length: (01) 1M ~ (04) 4M			
	PVC Jacket Male Connector Female Contact	-	NUB-20AMFM-SL7A ⑩
STRAIGHT-TO-STRAIGHT , Overmolded Double-Ended Cable Assembly, Jack, With Strain Relief, IP67 (Mated)			
⑩ Cable Length: (01) 1M ~ (05) 5M			
	End 1: Male Connector Female Contact End 2: Male Connector Female Contact	-	NUB20ML-NUBML-SA ⑩*
	End 1: Male Connector Female Contact End 2: Female Connector Male Contact	-	NUB20ML-NUBFL-SA ⑩*
	End 1: Male Connector Female Contact End 2 Non-Waterproof Type A: Male Connector Male Contact	NUB20ML-NAML-SA ⑩*	-
Field Serviceable/Installable, Jack, STRAIGHT , Without Strain Relief, IP67 (Mated)			
Sealing Nut Torque Value: 3.5 ~ 5 kgf.cm Cable O.D.: 3.8 ~ 5.5mm Wire Size: 28 ~ 22AWG (0.08 ~ 0.34mm ²)			
	Solder Type Male Connector Female Contact	-	NUB-20BMFA-SL7001
STRAIGHT , Overmolded Cable Assembly, Free Cable End, With Strain Relief, IP67 (Mated)			
⑩ Cable Length: (01) 1M ~ (04) 4M			
	PVC Jacket Female Connector Male Contact	-	NUB-20AFMM-SL7A ⑩
STRAIGHT-TO-STRAIGHT , Overmolded Double-Ended Cable Assembly, With Strain Relief, IP67 (Mated)			
⑩ Cable Length: (A05) 0.5M ~ (005) 5M			
	End 1: Female Connector Male Contact End 2: Female Connector Male Contact	-	NUB20FL-NUBFL-SA ⑩*
	End 1: Male Connector Female Contact End 2 Non-Waterproof Type A: Male Connector Male Contact	NUB20FL-NAML-SA ⑩	-

Mating

Pair

Accessories Waterproof Cap

Size	Mating Part	Mating Style	Gender of Mating Part	Attachment	Part Number
Standard Size 5/8"-27 UNS	Receptacle	Screw Thread	Male	With Chain	CAP-WABMSPB1
			Male	With Rubber Lead	CAP-WABMSPC1
	Female		With Rubber Lead	CAP-WABFSPC1	
	Male		None	CAP-WABMSMA1	

Micro USB SWIFT

Packing Information

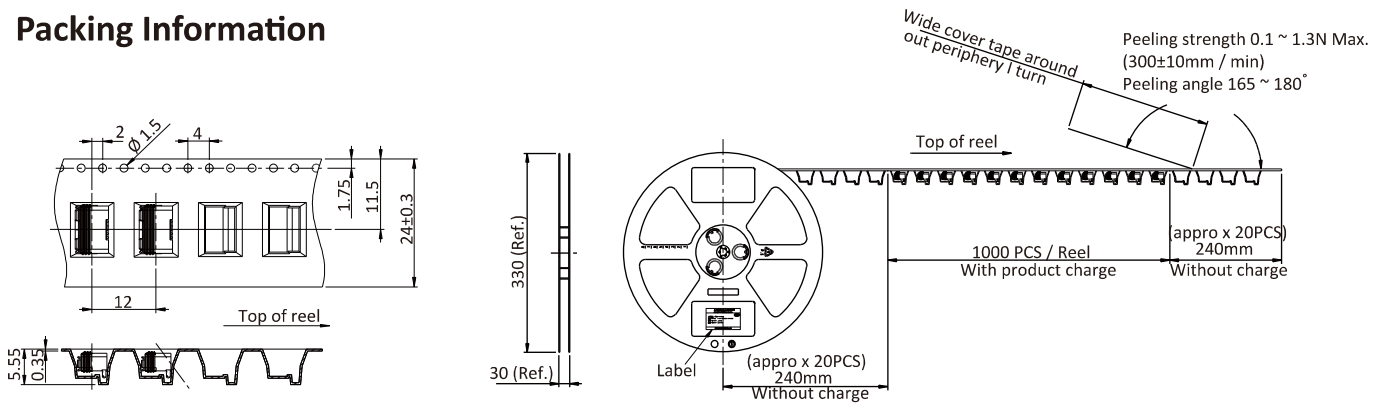

One Carton can put in the 5PCS(Max.) Box

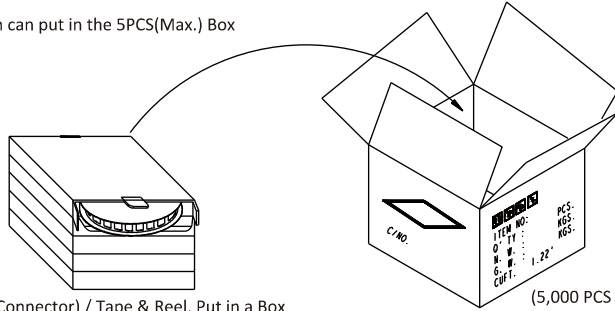

1,000 PCS (Connector) / Tape & Reel, Put in a Box

(5,000 PCS / Carton)

(Unit: mm)

Panel Cut Out

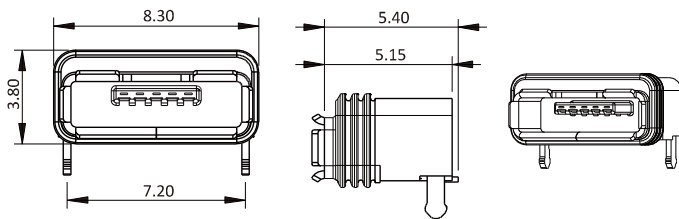

Waterproof Rating	Part Number
IP67 (Unmated, 1M / 30mins)	MUC-20PFFR-JS7002
IP68 (Unmated, 1M / 24h)	MUC-20PFFR-JS8A02
IP68 (Unmated, 5M / 24h)	MUC-20PFFR-JS8B02
IP68 (Unmated, 10M / 3h)	MUC-20PFFR-JS8C02

Connector/Contact Gender: Female Connector Female Contact

Panel Cut Out

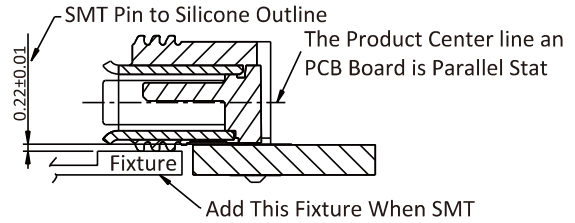
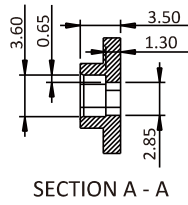
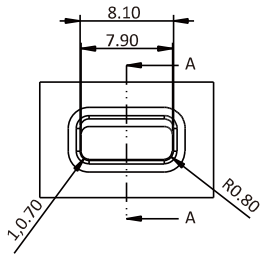

TOLERANCE Recommended Case Cut Out
.XX±0.05 SCALE 2 : 1

(Unit: mm)

Specification	Micro USB Type B	
Rated Voltage (AC/DC)	30V (AC), 5V (DC)	
Nominal Current	(1.8A) 1 & 5 Pin (1.0A) 2, 3 & 4 Pin	
Data Transfer Rate	2.0	
Plastic / Metal	Plastic	
STRAIGHT, Overmolded Cable Assembly, Free Cable End, With Strain Relief, IP67 (Mated)		
⑩ Cable Length: (01) 1M ~ (05) 5M		
	PVC Jacket Connector/Contact Gender: Male	MUB-20AMMM-QL7A ⑩
STRAIGHT-TO-STRAIGHT, Overmolded Double-Ended Cable Assembly, With Strain Relief, IP67 (Mated)		
⑩ Cable Length: (A05) 0.5M ~ (005) 5M		
	PVC Jacket End 1: Male Connector Male Contact End 2: Male Connector Male Contact	MUB20ML-MUBML-QA ⑩*
	PVC Jacket End 1: Male Connector Male Contact End 2: Female Connector Female Contact	MUB20ML-MUBFL-QA ⑩*
	PVC Jacket End 1: Male Connector Male Contact End 2: Non-waterproof Type A Male Connector Male Contact	MUB20ML-NAML-QA ⑩
STRAIGHT, Overmolded Cable Assembly, Free Cable End, With Strain Relief, IP67 (Mated)		
⑩ Cable Length: (01) 1M ~ (05) 5M		
	PVC Jacket Connector/Contact Gender: Female	MUB-20AFFM-QL7A ⑩
STRAIGHT-TO-STRAIGHT, Overmolded Double-Ended Cable Assembly, With Strain Relief, IP67 (Mated)		
⑩ Cable Length: (A05) 0.5M ~ (005) 5M		
	End 1: Female Connector Female Contact End 2: Female Connector Female Contact	MUB20FL-MUBFL-QA ⑩*
	End 1: Female Connector Female Contact End 2: Non-waterproof Type A Male Connector Male Contact	MUB20FL-NAML-QA ⑩

* Upon Request

Type C SWIFT - LP

SWIFT - LP

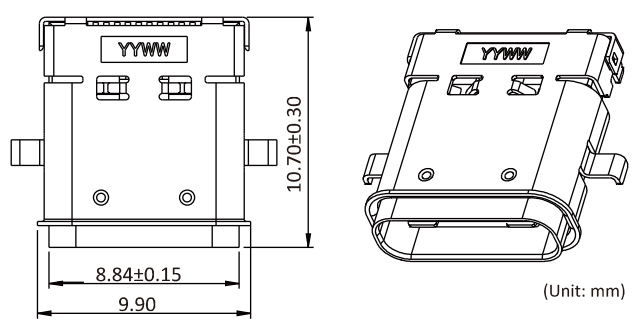
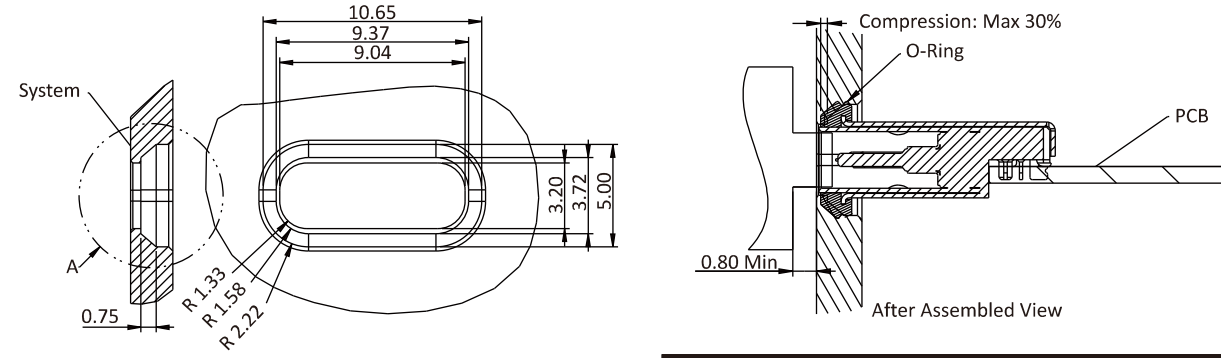

Assembly Type	Transfer Speed	Nominal Current	Part Number
<small>Connector/Contact Gender: Female Connector Female Contact</small>			
Snap In	Up To 10Gbps	Up To 5A	Receptacle, IP67 (Unmated)
			UC-00PFFH-QF7001 (PCB Pin Length: 0.6mm)
			UC-00PFFH-QF7002 (PCB Pin Length: 1.2mm)
			Receptacle, IP68 (Unmated)
			UC-00PFFH-QF8001 (PCB Pin Length: 0.6mm)
			UC-00PFFH-QF8002 (PCB Pin Length: 1.2mm)

Packing Information

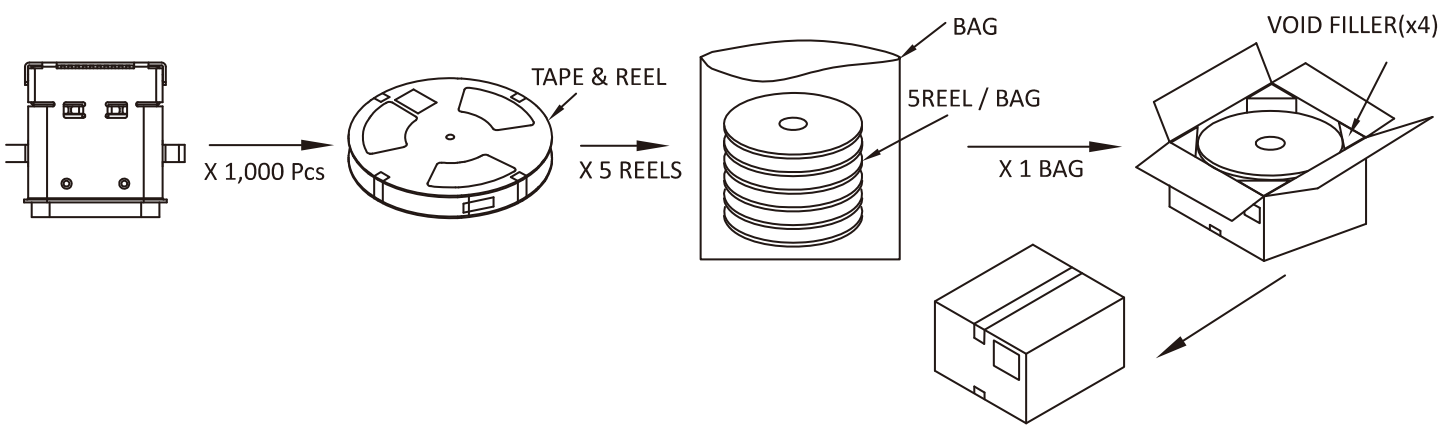
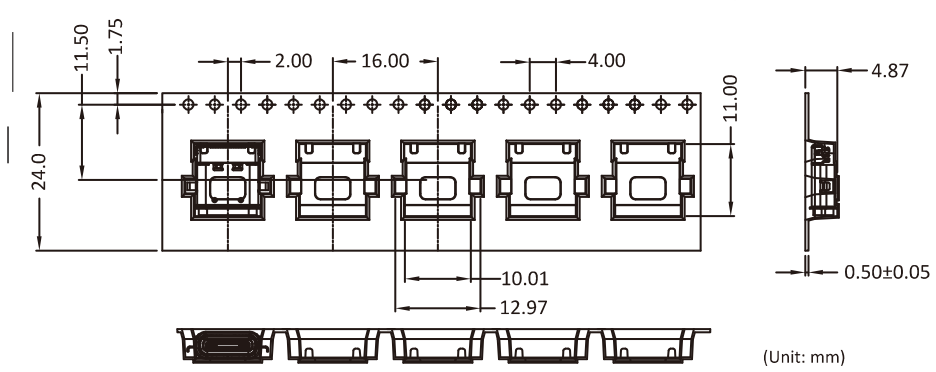
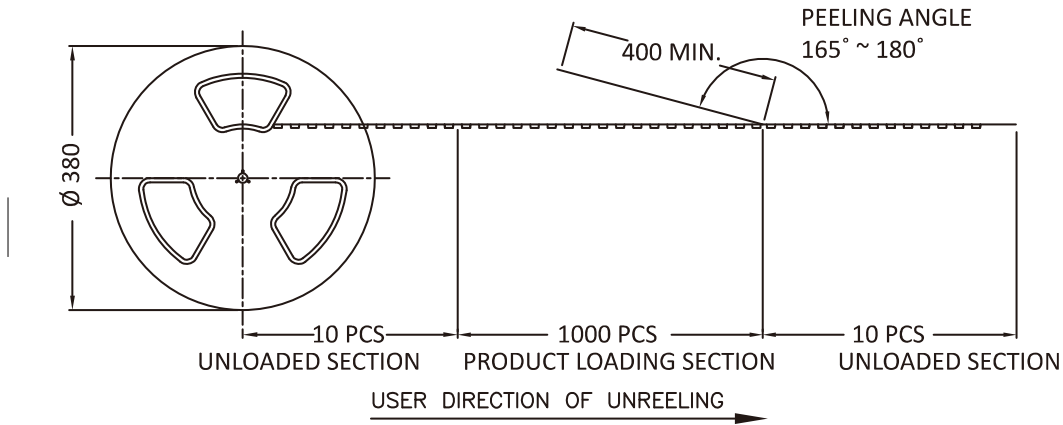

Panel Cut Out

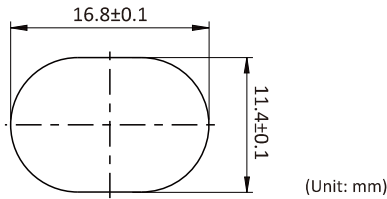

Specification		Type C
Rated Voltage (AC/DC)		30V (DC)
Nominal Current		Up to 3A
Data Transfer Rate		Up to 5Gbps
Plastic / Metal		Plastic
Receptacle, Square Flange, USB 3.2 Gen 2, IP68 (Unmated)		
Nut Torque Value: 3.5 ~ 5 kgf.cm Recommended Panel Thickness: max 4.0mm		
	180° PCB Type Female Connector Female Contact	UC-00PFFP-QS8001
	Y-beam, Flex. PCB Female Connector Female Contact	UC-00PFFY-QS8001*
STRAIGHT-TO-NON-WATERPROOF PLUG, Overmolded With Cable Double Ended, IP67 (Mated)		
⑩ Cable Length: USB 2.0: (A05) 0.5M ~ (005) 5M, USB 3.2 Gen 1: (A05) 0.5M ~ (003) 3M		
	End 1 Type C (2.0): Female Connector Female Contact End 2 Non-Waterproof Type A: Male Connector Male Contact	UC20FL-NAML-QA ⑩
	End 1 Type C (3.2 Gen 1): Female Connector Female Contact End 2 Non-Waterproof Type A: Male Connector Male Contact	UC30FL-NAML-QB ⑩*
	End 1 Type C (3.2 Gen 1): Female Connector Female Contact End 2 Non-Waterproof Type C: Male Connector Male Contact	UC30FL-NCML-QB ⑩
STRAIGHT-TO-STRAIGHT, Overmolded Double-Ended Cable Assembly, IP67 (Mated)		
⑩ Cable Length: USB 3.2 Gen 2: (A05) 0.5M ~ (003) 3M		
	End 1 Type C: Female Connector Female Contact End 2 Type C: Female Connector Female Contact	UC30FL-UCFL-QA ⑩*
STRAIGHT-TO-NON-WATERPROOF PLUG, Overmolded With Cable Double Ended, IP67 (Mated)		
⑩ Cable Length: USB 2.0: (A05) 0.5M ~ (005) 5M, USB 3.2 Gen 2: (A05) 0.5M ~ (003) 3M		
	End 1 Type C (2.0): Male Connector Male Contact End 2 Non-Waterproof Type A: Male Connector Male Contact	UC20ML-NAML-QA ⑩
	End 1 Type C (3.2 Gen 1): Male Connector Male Contact End 2 Non-Waterproof Type A: Male Connector Male Contact	UC30ML-NAML-QB ⑩
	End 1 Type C (3.2 Gen 1): Male Connector Male Contact End 2 Non-Waterproof Type C: Male Connector Male Contact	UC30ML-NCML-QB ⑩*
STRAIGHT-TO-WATERPROOF PLUG, Overmolded With Cable Double Ended, IP67 (Mated)		
⑩ Cable Length: USB 2.0: USB 3.2 Gen 2: (A05) 0.5M ~ (003) 3M		
	End 1 Type C: Male Connector Male Contact End 2 Type C: Male Connector Male Contact	UC30ML-UCML-QB ⑩*
	End 1 Type C: Male Connector Male Contact End 2 Type C: Female Connector Female Contact	UC30ML-UCFL-QB ⑩*

M a t i n g

P a i r

Panel Cut Out

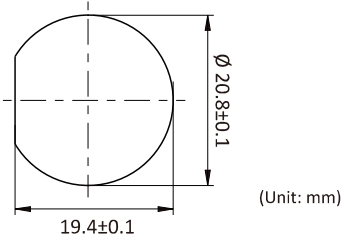

Specification		Type C	
Rated Voltage (AC/DC)		30V (DC)	
Nominal Current		Up To 5A	
Data Transfer Rate		3.2 Gen 2	
Plastic / Metal		Plastic	Metal
Receptacle, Square Flang, FRONT Fastened Nut, IP67 (Unmated) Connector/Contact Gender: Male Connector Female Contact Screw Thread Nut Torque Value: 3.5 ~ 5 kgf.cm Recommended Panel Thickness: with cap: 2.8mm, without cap: 4.0mm			
 Y-beam (Packed With Finish Product)	Y-beam, Flex. PCB	UC-00PMFY-SC7001	USC-00PMFY-SC7001*
STRAIGHT-TO-STRAIGHT , Overmolded Double-Ended Cable Assembly, IP67 (Mated), With Plastic Interlocking Conduit ⑩ Cable Length: USB 3.2 Gen 2: (A05) 0.5M ~ (003) 3M			
	End 1 Type C: Male Connector Female Contact End 2 Type C: Male Connector Male Contact	UC30ML-UCML-SC ⑩*	USC30ML-USCML-SC ⑩*
	End 1 Type C: Male Connector Female Contact End 2 Type C: Female Connector Male Contact	UC30ML-UCFL-SC ⑩*	USC30ML-USCFL-SC ⑩*
	End 1 Type C: Male Connector Female Contact End 2 Non-Waterproof Type C: Male Connector Male Contact	UC30ML-NCML-SC ⑩*	USC30ML-NCML-SC ⑩*
STRAIGHT-TO-STRAIGHT , Overmolded Double-Ended Cable Assembly, IP67 (Mated), Without Conduit ⑩ Cable Length: USB 3.2 Gen 2: (A05) 0.5M ~ (003) 3M			
	End 1 Type C: Male Connector Female Contact End 2 Type C: Male Connector Female Contact	UC30ML-NUCML-SC ⑩*	USC30ML-NUCML-SC ⑩*
	End 1 Type C: Male Connector Female Contact End 2 Type C: Female Connector Male Contact	UC30ML-NUCFL-SC ⑩*	USC30ML-NUCFL-SC ⑩*
	End 1 Type C: Male Connector Female Contact End 2 Non-Waterproof Type C: Male Connector Male Contact	UC30ML-NNCML-SC ⑩*	USC30ML-NNCML-SC ⑩*
STRAIGHT-TO-STRAIGHT , Overmolded Double-Ended Cable Assembly, IP67 (Mated), With Plastic Interlocking Conduit ⑩ Cable Length: USB 3.2 Gen 2: (A05) 0.5M ~ (003) 3M			
	End 1 Type C: Female Connector Male Contact End 2 Type C: Female Connector Male Contact	UC30FL-UCFL-SC ⑩*	USC30FL-USCFL-SC ⑩*
	End 1 Type C: Female Connector Male Contact End 2 Non-Waterproof Type C: Male Connector Male Contact	UC30FL-NCML-SC ⑩	USC30FL-NCML-SC ⑩
STRAIGHT-TO-STRAIGHT , Overmolded Double-Ended Cable Assembly, IP67 (Mated), Without Conduit ⑩ Cable Length: USB 3.2 Gen 2: (A05) 0.5M ~ (003) 3M			
	End 1 Type C: Female Connector Male Contact End 2 Type C: Female Connector Male Contact	UC30FL-NUCFL-SC ⑩*	USC30FL-NUCFL-SC ⑩*
	End 1 Type C: Female Connector Male Contact End 2 Non-Waterproof Type C: Male Connector Male Contact	UC30FL-NNCML-SC ⑩*	USC30FL-NNCML-SC ⑩*

Mating

Pair

* Upon Request

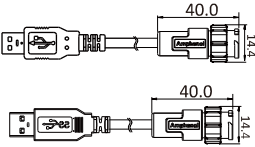
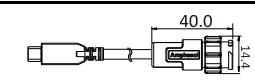
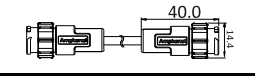
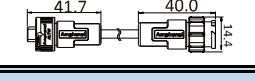
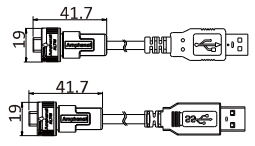
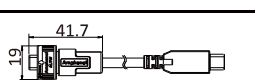
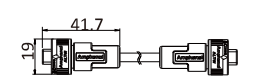
Specification		Type C	
Rated Voltage (AC/DC)		30V (DC)	
Nominal Current		Up to 3A	
Data Transfer Rate		2.0	3.2 Gen1
Plastic / Metal		Plastic	Plastic
STRAIGHT-TO-NON-WATERPROOF SOCKET, Overmolded Double-Ended Cable Assembly, IP68 (Mated)			
⑩ Cable Length: USB 2.0: (A05) 0.5M ~ (005) 5M, USB 3.2 Gen 1: (A05) 0.5M ~ (003) 3M			
	End 1 Type C: Male Connector Male Contact End 2 Non-Waterproof Type A: Male Connector Male Contact	UC20ML-NAML-KA ⑩	UC30ML-NAML-KB ⑩*
	End 1 Type C: Male Connector Male Contact End 2 Non-Waterproof Type C: Male Connector Male Contact	UC20ML-NCML-KA ⑩*	UC30ML-NCML-KB ⑩
STRAIGHT-TO-WATERPROOF SOCKET, Overmolded Double-Ended Cable Assembly, IP68 (Mated)			
⑩ Cable Length: USB 2.0: (A05) 0.5M ~ (005) 5M, USB 3.2 Gen 1: (A05) 0.5M ~ (003) 3M			
	End 1 Type C: Male Connector Male Contact End 2 Type C: Male Connector Male Contact	UC20ML-UCML-KA ⑩*	UC30ML-UCML-KB ⑩*
	End 1 Type C: Male Connector Male Contact End 2 Type C: Female Connector Female Contact	UC20ML-UCFL-KA ⑩*	UC30ML-UCFL-KB ⑩*
STRAIGHT-TO-NON-WATERPROOF SOCKET, Overmolded Double-Ended Cable Assembly, IP68 (Mated)			
⑩ Cable Length: USB 2.0: (A05) 0.5M ~ (005) 5M, USB 3.2 Gen 1: (A05) 0.5M ~ (003) 3M			
	End 1 Type C: Female Connector Female Contact End 2 Non-Waterproof Type A: Male Connector Male Contact	UC20FL-NAML-KA ⑩	UC30FL-NAML-KB ⑩*
	End 1 Type C: Female Connector Female Contact End 2 Non-Waterproof Type C: Male Connector Male Contact	UC20FL-NCML-KA ⑩*	UC30FL-NCML-KB ⑩
STRAIGHT-TO-WATERPROOF SOCKET, Overmolded Double-Ended Cable Assembly, IP68 (Mated)			
⑩ Cable Length: USB 2.0: (A05) 0.5M ~ (005) 5M, USB 3.2 Gen 1: (A05) 0.5M ~ (003) 3M			
	End 1 Type C: Female Connector Female Contact End 2 Type C: Female Connector Female Contact	UC20FL-UCFL-KA ⑩*	UC30FL-UCFL-KB ⑩*

M
a
t
i
n
g

P
a
i
r