

---

# PRODUCT APPLICATION

[www.ct-micro.com](http://www.ct-micro.com)

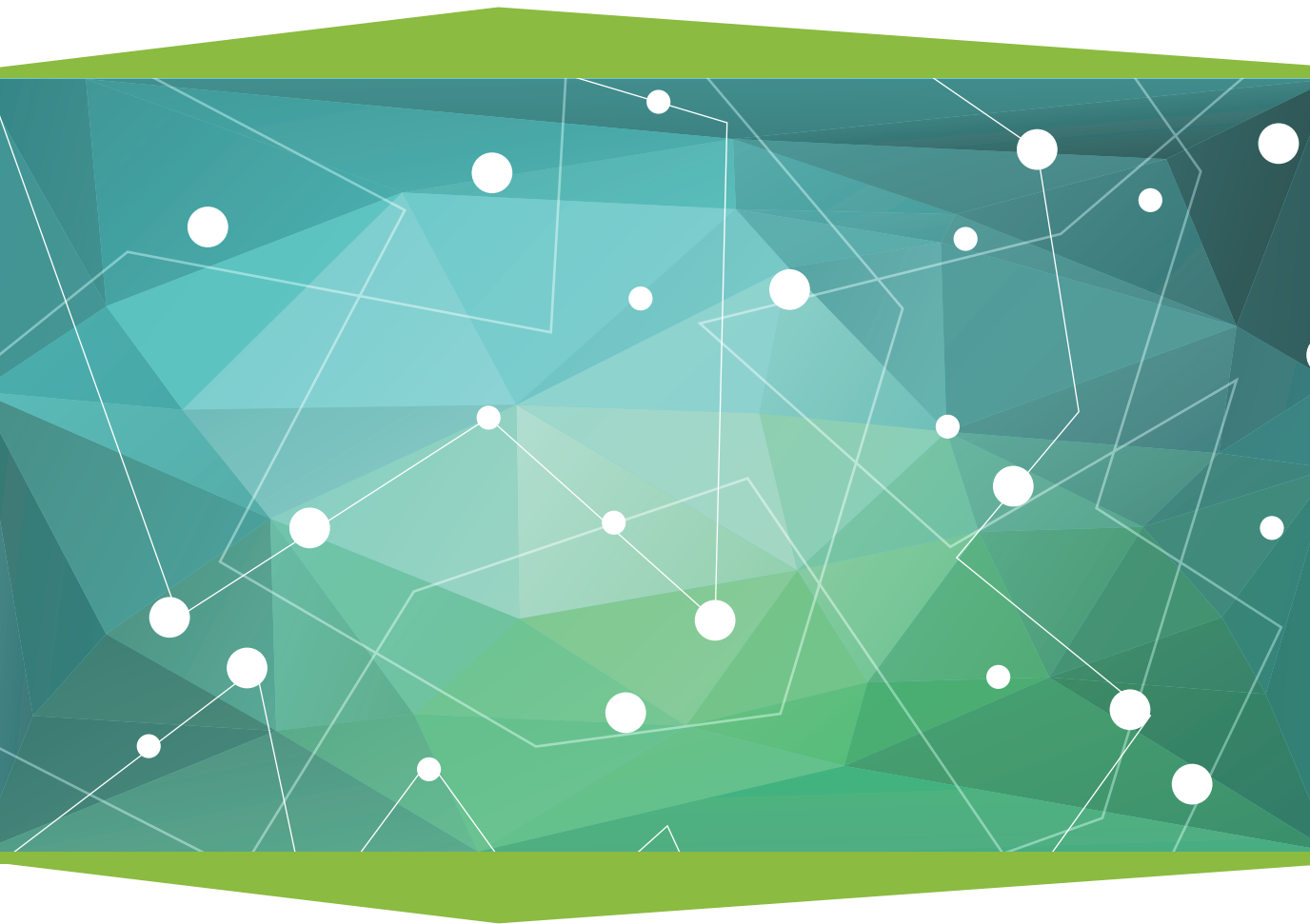



# IRPD / MOSFET TOUCH PANEL APPLICATION

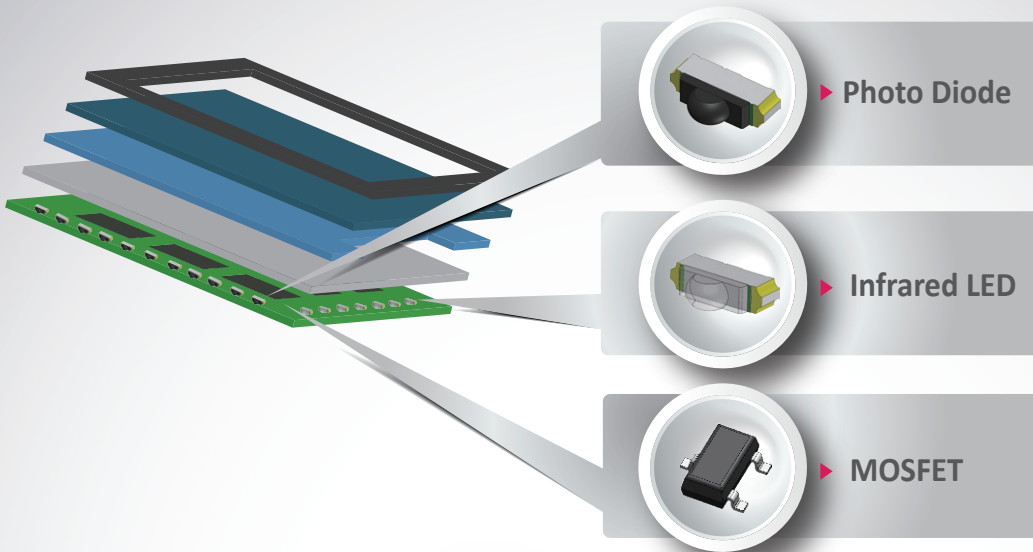

## CUSTOMIZED LED

High Intensity / Wide Viewing Angle / Slim Package

### EMITTER

Product Name	Dimension (mm)	Viewing Angle (°)	Peak Wavelength (nm @I <sub>f</sub> =20mA)
1608-09	1.60*0.80*0.94	75	850/880/940/1050/1350
1608-11	1.60*0.80*1.11	100/70	850/880/940
2406-14	2.40*0.60*1.39	150/110	850/880/940
3010-20	3.00*1.00*2.00	160/150	850/880/940/1050/1350
3015-12	3.00*1.50*1.21	85	850/880/940/1050/1350
3016-24	3.00*1.60*2.34	60	850/880/940/1050/1350

### RECEIVER

Product Name	Dimension (mm)	Spectrum Sensitivity (nm)
1608-09	1.60*0.80*0.94	400~1100
1608-11	1.60*0.80*1.11	400~1100
2406-14	2.40*0.60*1.39	400~1100
3010-20	3.00*1.00*2.00	400~1100
3015-12	3.00*1.50*1.21	400~1100
3016-24	3.00*1.60*2.34	400~1100
3328-11	3.20*2.70*1.10	400~1100
3930-11	3.90*3.00*1.10	400~1100

### MOSFET

Product Name	Dimension (mm)	Type	V <sub>DS</sub> (V)	I <sub>DS</sub> (A)
CTL0422PS-R3	SOT-23	P	-20	-4.2
CT3A01-R3	SOT-23	N	20	3.2
CTL0383NS-R3	SOT-23	N	30	3.8
CT3400A-R3	SOT-23	N	30	5.8

# CUSTOMIZED LED HEALTHCARE MANAGEMENT APPLICATION



## CUSTOMIZED LED EMITTER

Product Name	Dimension (mm)	Viewing Angle (°)	Peak Wavelength (nm @I <sub>f</sub> =20mA)
1608-09	1.60*0.80*0.94	75	520/620/660/850/880/940/1050
1615-07	1.60*1.50*0.70	120	520/620/660/910/940
3015-12	3.00*1.50*1.21	85	520/620/660/880/940/1050/1350
3328-11	3.30*2.70*1.10	120	520/620/660/880/940/1050/1350

## RECEIVER

Product Name	Dimension (mm)	Spectrum Sensitivity (nm)
3328-11	3.20*2.70*1.10	400~1100
3930-11	3.90*3.30*1.10	400~1100
4437-06	4.40*3.70*0.54	400~1100

# IR / PHOTO COUPLER IoT (INTERNET of THINGS) APPLICATION



## CUSTOMIZED LED EMITTER

Product Name	Dimension (mm)	Viewing Angle (°)	Peak Wavelength (nm @ <sub>I<sub>f</sub></sub> = 20mA)
1608-09	1.60*0.80*0.94	75	940
3015-12	3.00*1.50*1.21	85	940

## RECEIVER

Product Name	Dimension (mm)	Spectrum Sensitivity (nm)
3328-11	3.20*2.70*1.10	400~1100
3930-11	3.90*3.30*1.10	400~1100

## PHOTO COUPLER

Product Name	Package	V <sub>iso</sub> (rms) (V)
CT3053	DIP-6*	5000
CT3063	DIP-6*	5000
CT816	DIP-4*	5000
CT357	Full Pitch MFP-4L	3750
CTH217	Half Pitch MFP-4L	3750

Note: \*Different lead forming options available.

# PHOTO COUPLER HOME APPLIANCES APPLICATION

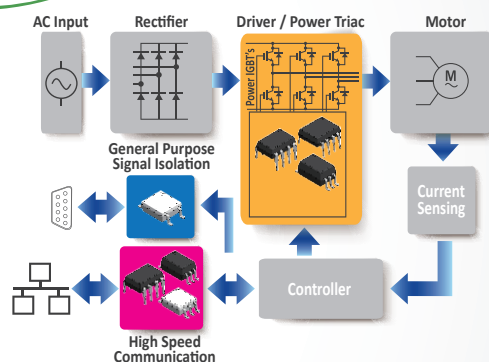

## GATE DRIVER

Product Name	Package	V <sub>iso</sub> (rms) (V)
CT3120	DIP-8*	5000
CT3150	DIP-8*	5000
CTS700	SDIP-6	5000
CTS701	SDIP-6	5000
CTW3120	Widebody-8L	5000

Note: \*Different lead forming options available.

## HIGH SPEED COUPLER

Product Name	Package	V <sub>iso</sub> (rms) (V)
CTS601	SDIP-6	5000
CTM611	Full Pitch MFP-5L	3750
CTM452	Full Pitch MFP-5L	3750
6N137	DIP-8*	5000

Note: \*Different lead forming options available.

## GENERAL PURPOSE COUPLER

Product Name	Package	V <sub>iso</sub> (rms) (V)
CT357	Full Pitch MFP-4L	3750
CT816	DIP-4*	5000
CTH217	Half Pitch MFP-4L	3750

Note: \*Different lead forming options available.

## PHOTO TRIAC

Product Name	Package	V <sub>iso</sub> (rms) (V)
CT3053	DIP-6*	5000
CT3063	DIP-6*	5000
CTT0223		
CTT1213	DIP-7*	5000
CTT3223		

Note: \*Different lead forming options available.

# PHOTO COUPLER POWER SUPPLY / CHARGER / INVERTER / BMS APPLICATION

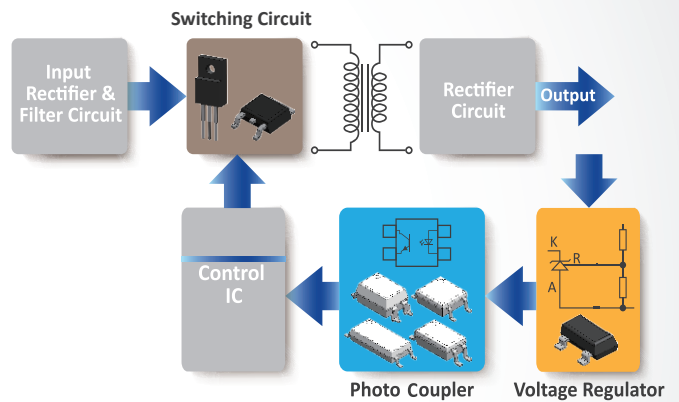
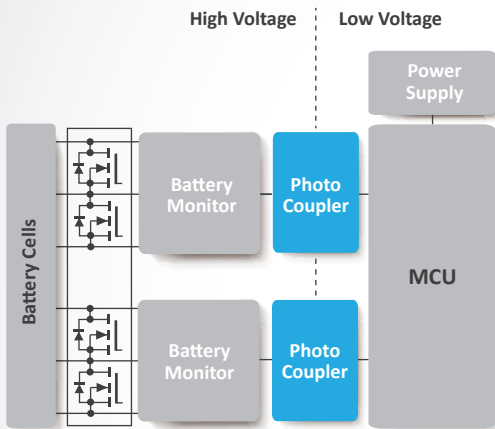
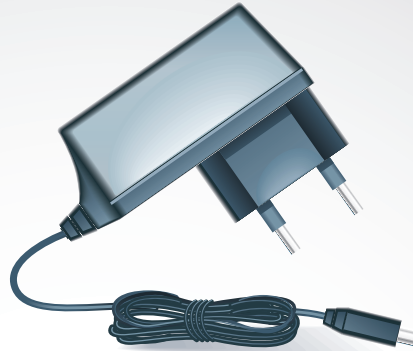
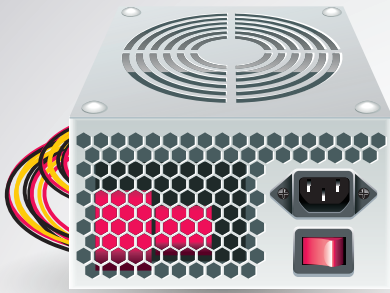

## PHOTO COUPLER

Product Name	Package	V <sub>iso</sub> (rms) (V)
CT816	DIP-4*	5000
CT817	DIP-4*	5000
CT357	Full Pitch MFP-4L	3750
CTH217	Half Pitch MFP-4L	3750
CT1010-W, CT1011-W, CT1012-W, CT1013-W, CT1014-W, CT1015-W, CT1016-W, CT1017-W, CT1018-W, CT1019-W.	Long Creepage-4L	5000

Note: \*Different lead forming options available.

## VOLTAGE REGULATOR

Product Name	Package
CT431L	SOT-23
CT432	SOT-23

## SWITCHING CIRCUIT

Product Name	Package
CTV0270NS	TO-220F
CTV0470NS	TO-220F, TO-252
CTV0670NS	TO-220F, TO-252
CTV0265NS	TO-220F, TO-252
CTV0465NS	TO-220F, TO-252
CTV0865NS	TO-220F
CTV0260NS	TO-220F, TO-252
CTV0460NS	TO-220F, TO-252
CTV1060NS	TO-220F
CTV1260NS	TO-220F
CTV0150NS	TO-220F, TO-252
CTV0350NS	TO-220F, TO-252
CTV0450NS	TO-220F, TO-252
CTV0550NS	TO-220F, TO-252

## GENERAL PURPOSE COUPLER

Product Name	Package	V <sub>iso</sub> (rms) (V)
CT816	DIP-4*	5000
CT817	DIP-4*	5000

Note: \*Different lead forming options available.

## GATE DRIVER

Product Name	Package	V <sub>iso</sub> (rms) (V)
CT3120	DIP-8*	5000
CT3150	DIP-8*	5000
CTS700	SDIP-6	5000
CTS701	SDIP-6	5000

Note: \*Different lead forming options available.

# PHOTO COUPLER SMART METERING SYSTEM APPLICATION



## CUSTOMIZED LED

### EMITTER

Product Name	Dimension (mm)	Viewing Angle (°)	Peak Wavelength (nm @IF=20mA)
1608-06	1.60*0.80*0.60	130	880/940
1608-09	1.60*0.80*0.94	75	880/940

### RECEIVER

Product Name	Dimension (mm)	Spectrum Sensitivity (nm)
1608-06	1.60*0.80*0.60	400~1100
1608-09	1.60*0.80*0.94	400~1100

### PHOTO COUPLER

Product Name	Package	V <sub>iso</sub> (rms) (V)
CT816	DIP-4*	5000
CT817	DIP-4*	5000
CT357	Full Pitch MFP-4L	3750
CTH217	Half Pitch MFP-4L	3750
CT1010-W, CT1011-W, CT1012-W, CT1013-W, CT1014-W, CT1015-W, CT1016-W, CT1017-W, CT1018-W, CT1019-W.	Long Creepage-4L	5000

Note: \*Different lead forming options available.

### VOLTAGE REGULATOR

Product Name	Package
CT431L	SOT-23
CT432	SOT-23

### HIGH SPEED COUPLER

Product Name	Package	V <sub>iso</sub> (rms) (V)
6N137	DIP-8*	5000
CT2531	DIP-8*	5000
CT2561	DIP-8*	5000

Note: \*Different lead forming options available.



# INFRARED COMPONENT



**MID 2219-09**  
2.20\*1.95\*0.90mm

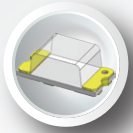

**SMD 1608-06**  
1.60\*0.80\*0.60mm

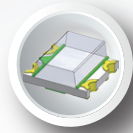

**SMD 1615-07**  
1.60\*1.50\*0.70mm

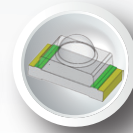

**SMD 1608-09**  
1.60\*0.80\*0.94mm



**SMD 1608-11**  
1.60\*0.80\*1.11mm

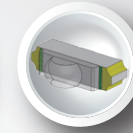

**SMD 2406-14**  
2.40\*0.60\*1.39mm

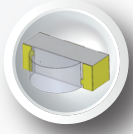

**SMD 3010-20**  
3.00\*1.00\*2.00mm

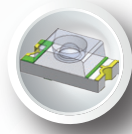

**SMD 3015-12**  
3.00\*1.50\*1.21mm

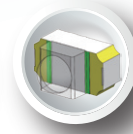

**SMD 3016-24**  
3.00\*1.60\*2.34mm

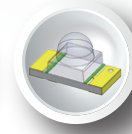

**SMD 3216-18**  
3.20\*1.60\*1.86mm

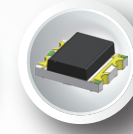

**SMD 3328-11**  
3.20\*2.70\*1.10mm



**SMD 3427-01**  
3.40\*2.70\*1.62mm



**SMD 3528-19**  
3.50\*2.80\*1.90mm

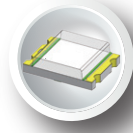

**SMD 3930-11**  
3.90\*3.30\*1.10mm

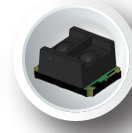

**SMD 4030-20**  
4.00\*3.00\*2.00mm

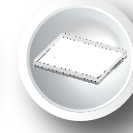

**SMD 4437-06**  
4.40\*3.70\*0.54mm

# PHOTO COUPLER



**DIP-4 (Standard)**  
6.50\*4.58\*3.50mm  
5.0 kVrms



**M Type**  
Forming Option  
5.0 kVrms

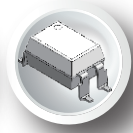

**S Type**  
Forming Option  
5.0 kVrms

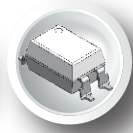

**SL Type**  
Forming Option  
5.0 kVrms



**SLM Type**  
Forming Option  
5.0 kVrms



**DIP-5 (Standard)**  
6.50\*7.12\*3.50mm  
5.0 kVrms



**DIP-6 (Standard)**  
6.50\*7.12\*3.50mm  
5.0 kVrms

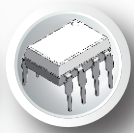

**DIP-8 (Standard)**  
6.60\*9.76\*3.50mm  
5.0 kVrms

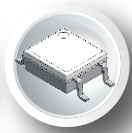

**MFP-4L**  
4.40\*3.60\*1.90mm  
3.75 kVrms

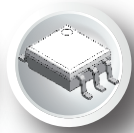

**MFP-5L**  
4.40\*3.60\*1.90mm  
3.75 kVrms



**Half Pitch MFP-4L**  
4.40\*2.35\*1.90mm  
3.75 kVrms



**Half Pitch MFP-16L**  
4.40\*10.30\*1.90mm  
3.75 kVrms



**Long Creepage-4L**  
7.60\*3.60\*1.86mm  
5.0 kVrms

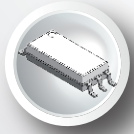

**Long Creepage-5L**  
7.60\*3.60\*1.86mm  
5.0 kVrms

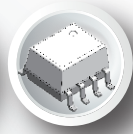

**SOP-8**  
3.92\*4.88\*3.18mm  
3.75 kVrms



**CTP17**  
4.00\*2.50\*1.50mm  
2.5 kVrms

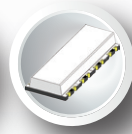

**CTP47**  
4.00\*10.30\*1.50mm  
2.5 kVrms

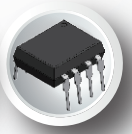

**Widebody (Standard)**  
9.00\*11.15\*3.90mm  
5.0 kVrms

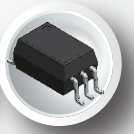

**SDIP-6**  
6.80\*4.58\*3.50mm  
5.0 kVrms

# MOSFET



**TO-263**  
15.40\*9.95\*4.53mm

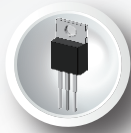

**TO-220**  
27.80\*10.10\*4.57mm

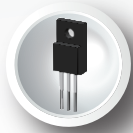

**TO-220F**  
27.60\*10.10\*4.60mm

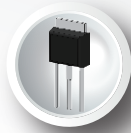

**TO-251**  
13.50\*6.50\*2.30mm

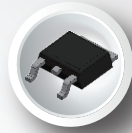

**TO-252**  
9.50\*6.50\*2.30mm

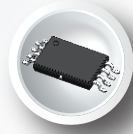

**TSSOP-8**  
3.00\*6.40\*0.85mm

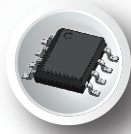

**SOP-8**  
4.90\*6.00\*1.67mm



**SOT-26**  
2.90\*2.80\*1.15mm



**SOT-23**  
2.90\*2.80\*1.15mm



**SOT-363**  
2.10\*2.10\*1.00mm

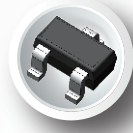

**SOT-523**  
1.60\*1.70\*0.80mm



**SOT-723**  
1.20\*1.20\*0.40mm

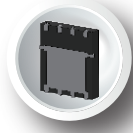

**PDFN5060**  
5.00\*6.00\*1.00mm

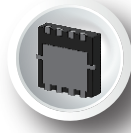

**PDFN3030**  
3.10\*3.30\*0.75mm

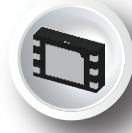

**DFN2030**  
2.00\*3.00\*0.75mm



[www.ct-micro.com](http://www.ct-micro.com)



### Malaysia

F-3A-3A, Jalan C180/1,  
Dataran C180,  
43200 Cheras, Selangor,  
Malaysia  
TEL: +60 3 9082 3333  
FAX: +60 3 9082 1021

### Taiwan

8F., No.87, Zhongcheng Rd.,  
Tucheng Dist., New Taipei City 23674,  
Taiwan  
TEL: +886 2 22684958  
FAX: +886 2 22684959

### Shenzhen

1203- 1204, Block A,  
Jiabin Road, City Square Complex,  
Luohu District, Shenzhen 518001,  
China  
TEL: +86 755 61620062  
FAX: +86 755 61620061

### Korea

#4206, Ma-Dong,  
Chungang Circulation Complex,  
1258, Guro 2-Dong, Guro-Gu,  
Seoul, Korea 08217  
TEL: +82 10 3160 6399

### Germany

Weipertstrasse 8 – 10,  
74076 Heilbronn,  
Germany  
TEL: +49 7131 7669 310

### USA

5900 South Lake Forest Drive,  
Suite 300, Mckinney, Texas 75070,  
USA  
TEL: +1 469 931 5089

CT Micro International Corporation is a Customer oriented and Technology driven company who is dedicated in Design, Manufacturing, Marketing & Sales (DM<sup>2</sup>S) of Optoelectronic components, Discrete Semiconductor, and its related products in world-wide market.

