

852nm SM VCSEL Laser diode for Cesium D2 transition Line CPT



Description:

The PL-VCSEL-0852-1-A81-TO46 852nm VCSEL is a vertical emitting MOVPE grown GaAsP/AlGaAs Single Mode diode laser. The chips are mounted in TO5 can. Wavelength tuning can be achieved via laser current and temperature tuning. package with TEC and PD Built in. It is special designed for TDLAS Application. Good Narrow linewidth and wide tunability with TEC made it a great low cost choice for Rubidium Spectroscopy D1 transition.

Features:

- Vertical Cavity Surface-Emitting Laser
- Internal TEC and Thermistor, ESD protection
- Narrow linewidth
- 2 nm tunability with TEC
- Selection for Rubidium D1 transition

Applications:

- Tunable diode laser absorption spectroscopy
- Rubidium Spectroscopy
- Optical Clock (Rubidium)

E/O Specifications:

Condition: TO P = 20°C, IO P = 2.0 mA unless otherwise stated (TO P = chip backside temperature, controlled by the TEC)

Parameters	Symbol	Min	Typ	Max	Unit	Remark
Emission Wavelength	λ_R	852nm				
Threshold current	ITH		0.5		mA	
Output Power	Popt	0.25			mW	
Threshold Voltage	UTH		1.8		V	
Driving Current	IOP			2	mA	Popt = 0.3 mW
Laser voltage	UOP		2		V	Popt = 0.3 mW
Electro optic conversion rate	η_{WP}		12		%	Popt = 0.3 mW
Slope efficiency	η_S		0.3		W/A	
Differential series resistance	RS		250		Ω	Popt = 0.3 mW
3dB bandwidth	v3dB	0.10			GHz	Popt = 0.3 mW, Due to ESD protection diode
Relative intensity noise	RIN		-130	-120	dB/Hz	Popt = 0.3 mW @ 1 GHz
Wavelength tuning over current			0.6		nm/mA	
Wavelength tuning over temperature			0.06		nm/K	
Thermal resistance (VCSEL chip)	Rthermal	3		5	K/mW	
Side mode supression		25			dB	I = 2 mA
Beam divergence	θ	10		25	°	Popt = 0.3 mW, full width 1/e2
Spectral Width			100		MHz	Popt = 0.3 mW

Tec Characteristics	Unit	Min	Typ	Max	Remark
Tec Current	mA	-150(Heating)		+300(Cooling)	Proper Heart Sink Required
NTC Thermistor Resistance	K Ω	9.5	10.0	10.5	T=25°C @10 K Ω
NTC Thermistor Resistance	K Ω	$10/\exp\{3892-(1/289K-I/TO P)\}$			

Spectrum:

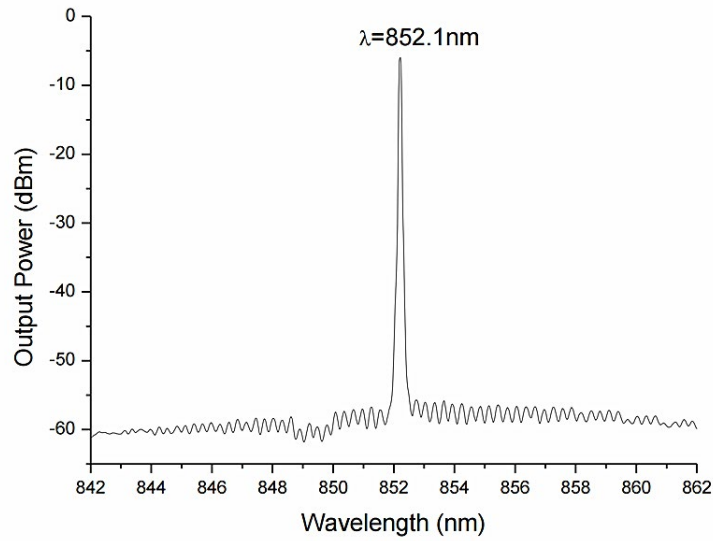

L-I Curve(T@25°C):

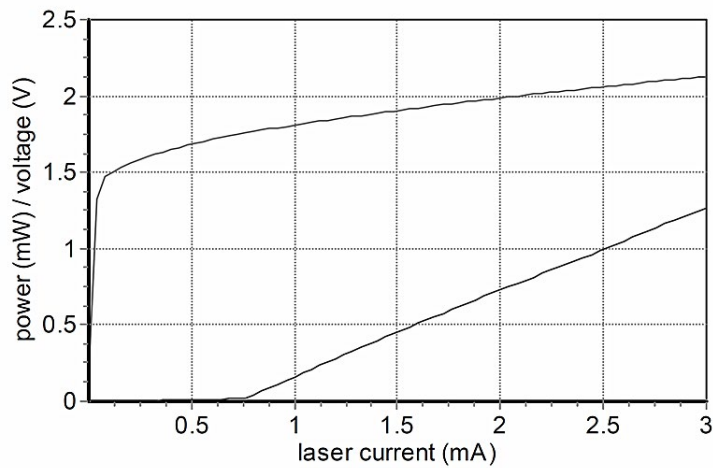

Temperature / wavelength tuning over TEC current*:

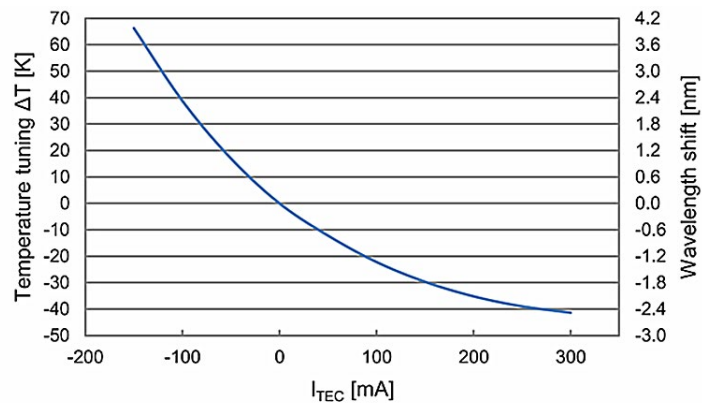

* TEC performance is dependent on heat load, ambient temperature and heatsink properties

Fabry Perot Spectrum:

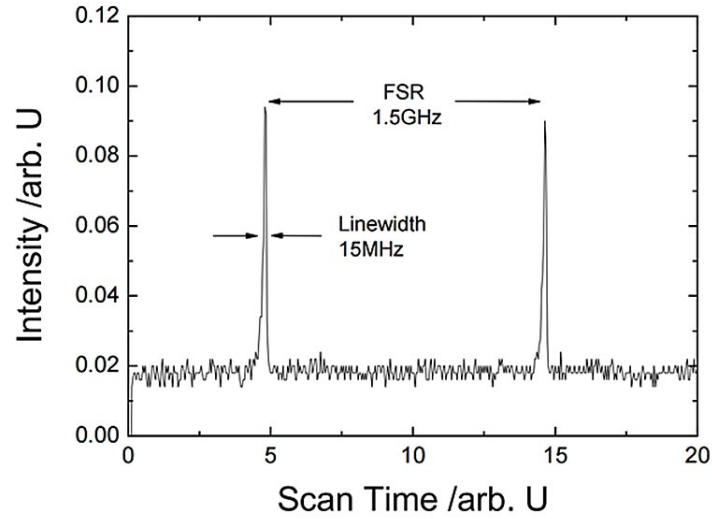

Package Size:

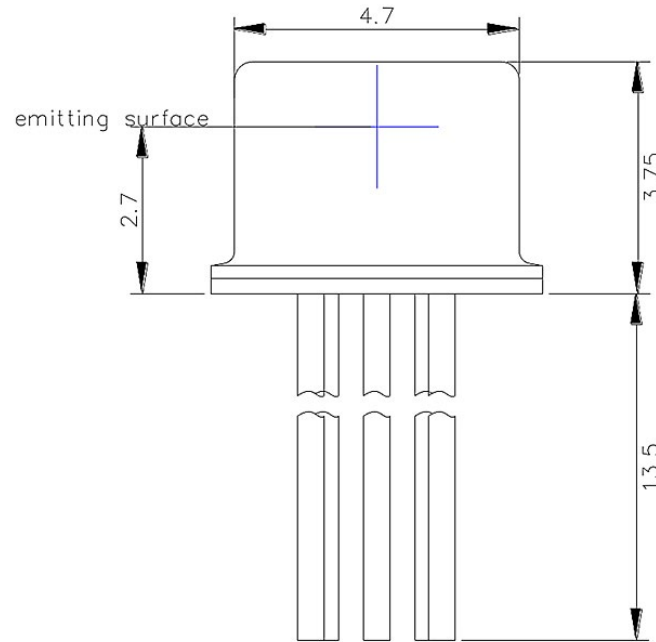

(Dimensions Unit in: mm)

Pin definition:

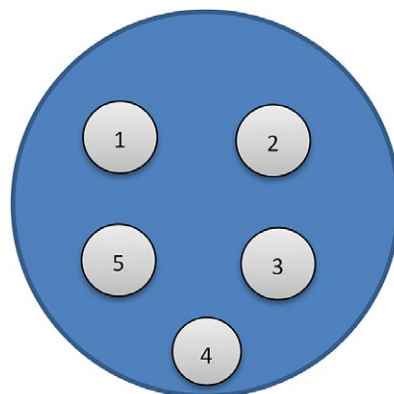

1	Thermistor-	4	NTC Thermistor -, Laser Cathode (-)
2	Thermistor+	5	Laser Anode (+)
3	NTC Thermistor +10kΩ at 25°C		

Without TEC Pin configuration:

Pin configuration

Unit :mm

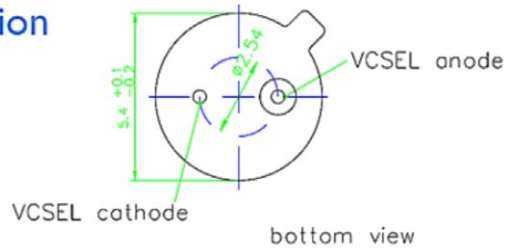

Absolute Maximum Ratings:

Item	Symbol	Unit	Min	Typ	Max	Testing Condition
Chip Temperature	TOP	°C	+10	25	40	
Forward Voltage	VR	V	0.8	1.2	1.8	
Electrical Power Dissipation	Pc	mw		-	5	
TEC Forward Current	IPF	mA	-150	-	+300	
Lead Soldering time		S		-	10s	260 °C
Store Temperature	TSTG	°C	-40	-	+85	2000hr
Operating Temperature	TOP	°C	-55	-	+125	

Ordering Info:

PL-VCSEL- □□□□-☆-▽- XX

□□□□: Wavelength

0760:760nm

0795:794.7nm

0852:852nm

1653.7: 1653.7nm

☆ : TEC

0: Without TEC

1: With TEC

▽ : Wavelength Tolerance

1: ±0.5nm

2: ±1.5nm

XX: Package

TO46

User Safety:

Safety and Operating Considerations

This device operates under reverse bias voltage, and the polarity of the device can't be reversed.

Operating the Photodiode outside of its maximum ratings may cause device failure or a safety hazard. Power supplies used with this component cannot exceed maximum peak optical power.

ESD PROTECTION—Electrostatic discharge (ESD) is the primary cause of unexpected laser diode failure. Take extreme precaution to prevent ESD. Use wrist straps, grounded work surfaces, and rigorous antistatic techniques when handling Photodiodes.