

850-940nm 200mW Mixed VCSEL Diode

MV-8594A-200M-4L-0A0

MV-8594A-200M-4L-0A0 consists of two VCSEL chips, one is 850nm 200mW and the other is 940nm 200mW, incorporated into in one 3528 packaging (P/Cu).

Features

- Single wavelength
- Low wavelength drift
- Dual VCSEL package
- Low threshold current
- High reliability
- Easy to collimate

Applications

- Proximity sensors
- Wristband pulse oximeter
- Gas sensor
- PM2.5/10 detector
- Smoke detector
- Steam sensor

PRODUCT IDENTIFY

Part Number	Description
MV-8594A-200M-4L-0A0	850-940nm 200mW mixed VCSEL Diode

CODE RULES

MV - 8594A - 200M - 4 L - 0 A 0

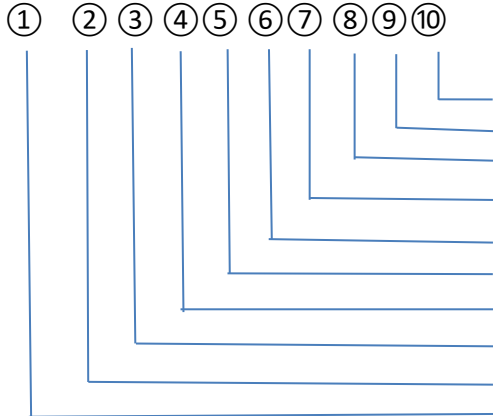

⑩ Annex, option 0
 ⑨ Product version, A
 ⑧ Accessories, 0= standard
 ⑦ Package type, 3528
 ⑥ Substrate, 4= P/Cu
 ⑤ Power units, M =milliwatts
 ④ Power, 200
 ③ Number of chips, A
 ② 1st Wavelength, 850 nm, 2nd wavelength, 940 nm
 ① Product classification, **Multi VCSEL**

No of chips	First wavelength	Second wavelength
A	1	1
B	0	2
C	0	3

I. Absolute maximum ratings

Parameter	Symbol	Rating	Unit
Case Operating Temp	Top	-40 to +85	°C
Storage Temp	Tsto	-40 to +105	°C



Reflow Soldering Temperature	Tsdr	260°C(10s)	°C
Reverse Voltage	Vr	5	V
Maximum Continuous Current	I _{max}	500	mA
ESD exposure (Human body) model	ESD	2K	V

Note:

1. Stresses greater than those listed under “Absolute Maximum Ratings” may cause permanent damage to the device. This is a stress rating only and functional operation of the device at these or other conditions above those indicated in the operations section for extended periods of time may affect reliability.
2. In its maximum rating diode laser operation could damage its performance or cause potential safety hazard such as equipment failure.
3. Electrostatic discharge is the main reason for the laser fault of the diode. Take effective precautions against ESD. When dealing with laser diodes, use the wrist strap, grounding work surface and strict antistatic technology.

II. Optical-electrical characteristics @25°C

850nm 200mW (CW mode)

Parameters	Symbol	Test Conditions	Min.	Typ.	Max.	Units
Optical Power Output	P _o	I _F =300mA		200	220	mW
Threshold Current	I _{TH}	-	-	500	-	mA
Forward Current	I _F	-	-	320	-	mA
Slope Efficiency	η	P _o =200mW	-	0.58	-	mW/mA
Power Conversion Efficiency	PCE	I _F =300mA	-	24		%
Peak Wavelength	λ _P	I _F =300mA	840	850	860	nm
Laser Forward Voltage	V _F	I _F =300mA	2.2	2.4	2.6	V
Series Resistance	R _S	I _F =300mA	-	8		Ohm
Beam Angle	θ	I _F =300mA	-	25	-	Degrees
Wavelength shift	∂λ _P /∂T	I _F =300mA	-	-	0.07	nm/°C

940nm 200mW (CW mode)

Parameters	Symbol	Conditions	Min.	Typ.	Max.	Unit
Optical Power	P _o	I _F =300mA	-	200	220	mW
Threshold Current	I _{th}	-	-	500	-	mA
Forward Current	I _F	-	-	300	-	mA
Power conversion efficiency	η	I _F =300mA	-	27	-	%
Slope efficiency	-	P _o =200mW	-	0.68	-	mW/mA
Peak Wavelength	-	I _F =300mA	930	940	950	nm
Laser Forward Voltage	V _f	I _F =300mA	2.2	2.4	2.6	V
Series Resistance	R	I _F =300mA	-	8	-	Ω
Original Beam Angle	-	I _F =300mA	-	25	-	Degrees
Wavelength Temp. drift	-	I _F =300mA	-	0.07	-	nm/°C
Soldering Temperature	-	-	-	-	260 (10s)	°C

- Note:**
1. Forward Voltage (V_F) measurement allowance is ±0.1 V.
 2. Peak Wavelength (λ_P) measurement allowance is ±1.5 nm.
 3. Others measurement allowance is ±10%.

III. LIV Graph and Wavelength

850nm 200mW:

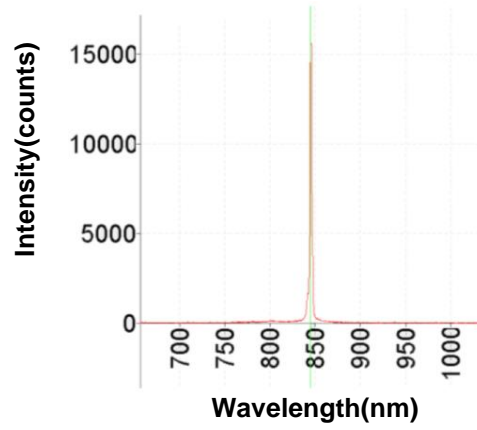
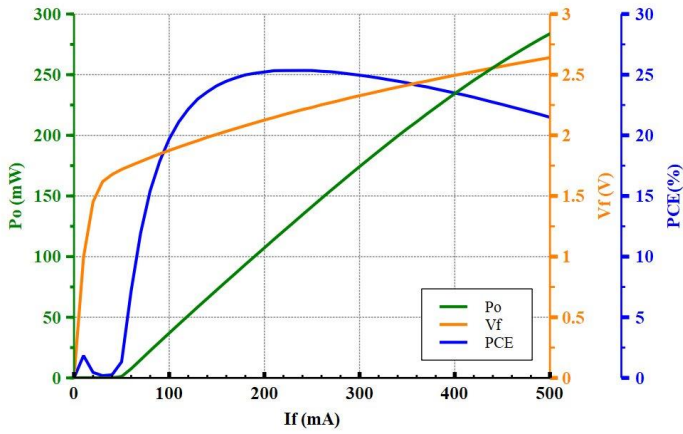

940nm 200mW:

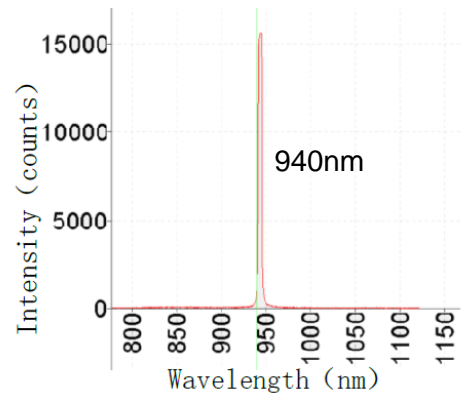
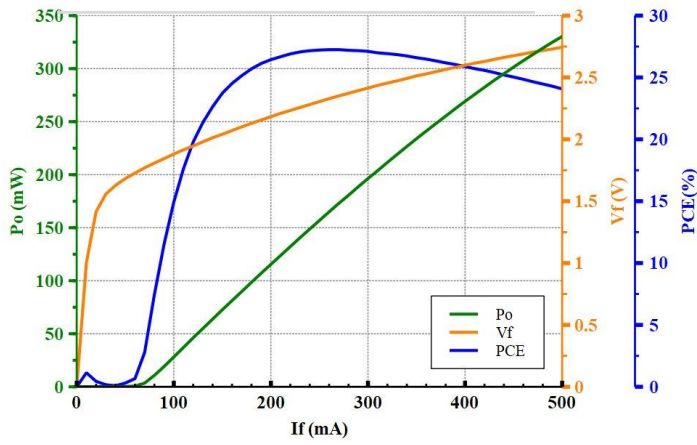

IV. Mechanical Schematics (3528 packaging, unit:mm)

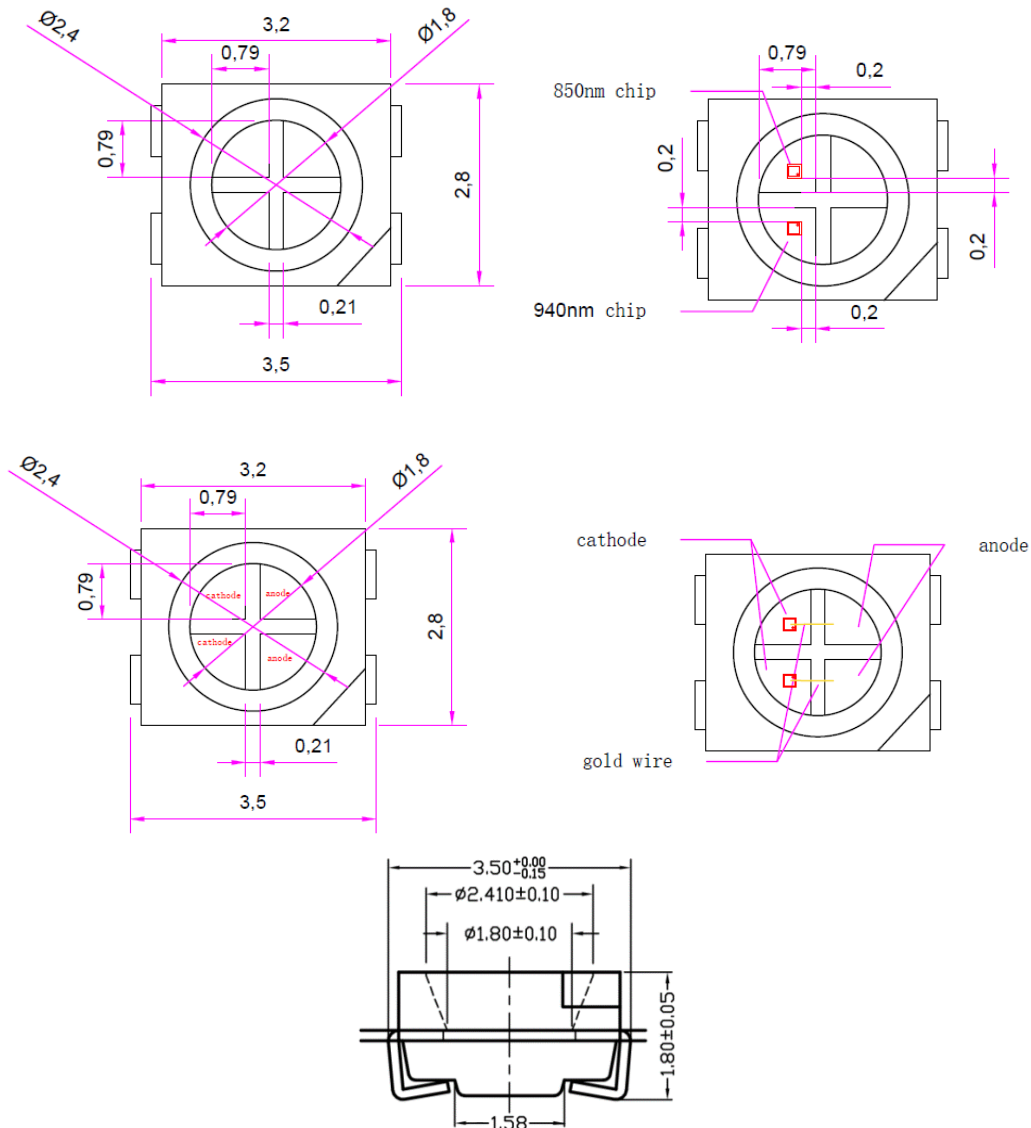

Note: There may be some changes between sample and drawing, thus, the actual spec please refer to the sample that you received. And if any question please contact us.

V. SMT reflow soldering curve

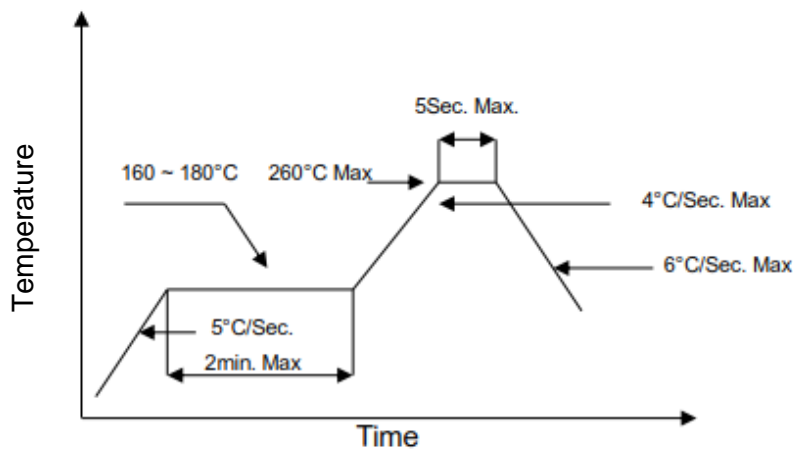

Note: Reflow soldering can be operated only one time. During the temperature ramp-up, no forces may

be exerted on the LD which could deform or damage them. After soldering completed, please also do not process until the product temperature ramp down to room temperature.

VI. Treatment and protection measures

Soldering precautions

The temperature of soldering iron must be controlled under 300°C during manual soldering. Also, VCSEL can be only soldered one time with the soldering time less than 3s. However, it is very hard to control the soldering temperature and homogenize solder paste because of the smaller size of VCSEL. In addition, it is easy to damage VCSEL structure even causes VCSEL losing efficacy. So, we advise you to use re-flow soldering machine for operation.

Storage precautions

Our products were sealed by aluminum foil bag attaching packed desiccant, they are moisture proof and anti-static. Please handle these gently to avoid damage. At the same time, please be ready for storage and take some moisture-proof measures to keep VCSEL away from dampness that may causes reliability failure.

Before opening, VCSEL must be saved for at least 90 days below 30°C with 60% RH.

After opening, VCSEL must be kept in an environment that temperature lower than 30°C and humidity lower than 60% RH and used up within 24 hours. When the storage humidity reaches and exceeds 60%, the products must be dehumidified at 60 °C for more than 24 hours before use.

Others

1. Please use solder paste to cure the laser diode.
2. Please make sure that the heat of VD has been completely conducted to metal shell, to avoid affecting the optical power output.
3. This VD can be only used in constant voltage and current.
4. Operating voltage and current, refer to the table in paragraph II .
5. Please do not aim the laser to people or animal.
6. You can observe the laser spot through an image monitoring equipment.
7. Please do not touch VD surface by naked hands or squeeze the sealant on LD surface, or it may cause wrong optical angle and distorted laser spot, even damage the VD.
8. Please use ceramic suction nozzle to absorb the VD, so as to avoid VD sticking to the nozzle.
9. Please add a 0.02 s blowing action after locating the laser diode to aluminum substrate.

VII. Revision history

Revision	Date	Description
V.01	2020/06/26	The first official edition (0003C5, 0011C1.19)

**Brightlaser reserves the right to make modification at any time due to improved design from time to time, the merit behind is to supply the best product possible.