

## 1572nm DFB Laser diode for CO<sub>2</sub> Sensing

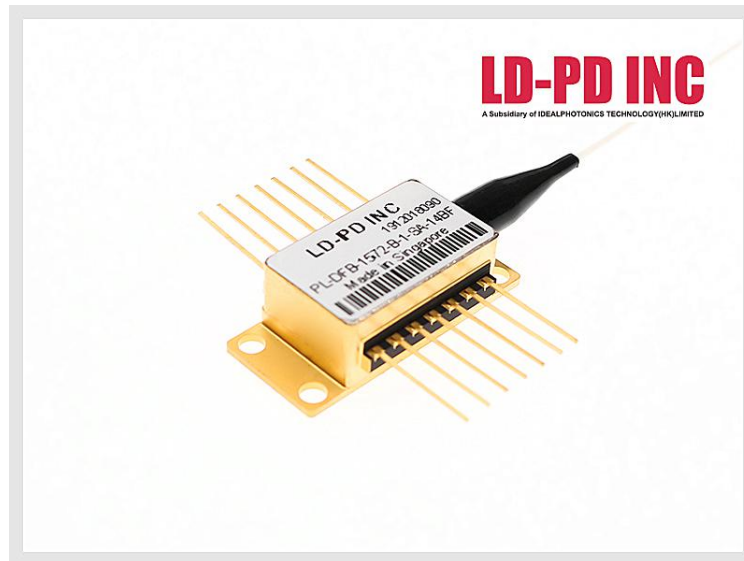

### Description

The PL-DFB-1572-A-1- SA-14BF 1572nm DFB laser diode module made by LD-PD is a cost effective, highly coherent laser source. The DFB laser diode chip is packaged in an industry standard hermetically sealed 14 pin butterfly package with TEC and PD Built in.

### Features

- Narrow Linewidth < 2MHz
- Excellent wavelength control and stability
- Industry Standard 14 pin Butterfly package
- Mode-Hop free tuning
- Excellent reliability
- Customer specific wavelengths available

### Application

- Tunable diode laser absorption spectroscopy
- CO<sub>2</sub> Monitoring

## Laser Specifications

Tsub=25°C, CW bias unless stated otherwise

Parameter	Symbol	Min	Typ	Max	Unit
Centre Wavelength	$\lambda$	1571.5	1572.0	1572.5	nm
Side Mode Suppression Ratio	SMSR	30	40		dB
Threshold Current	I <sub>th</sub>		20	30	mA
Operating Current	I <sub>op</sub>		80	120	mA
Chip output Power	P <sub>f</sub>	10	15	30	mW
Quantum Efficiency	$\eta$	0.08	0.12		mW/mA
Current Tuning Coefficient	$\Delta\lambda/\Delta I$		0.015		nm/mA
Temperature Tuning Coefficient	$\Delta\lambda/\Delta T$		0.12		nm/K
Forward Voltage	V <sub>f</sub>		1.3	2	V
Thermistor Resistance	R <sub>T</sub>	9.5	10	10.5	K $\Omega$
Thermistor Temp. Coefficient			-4.4		%/°C
Connector	FC/APC				

## Spectrum

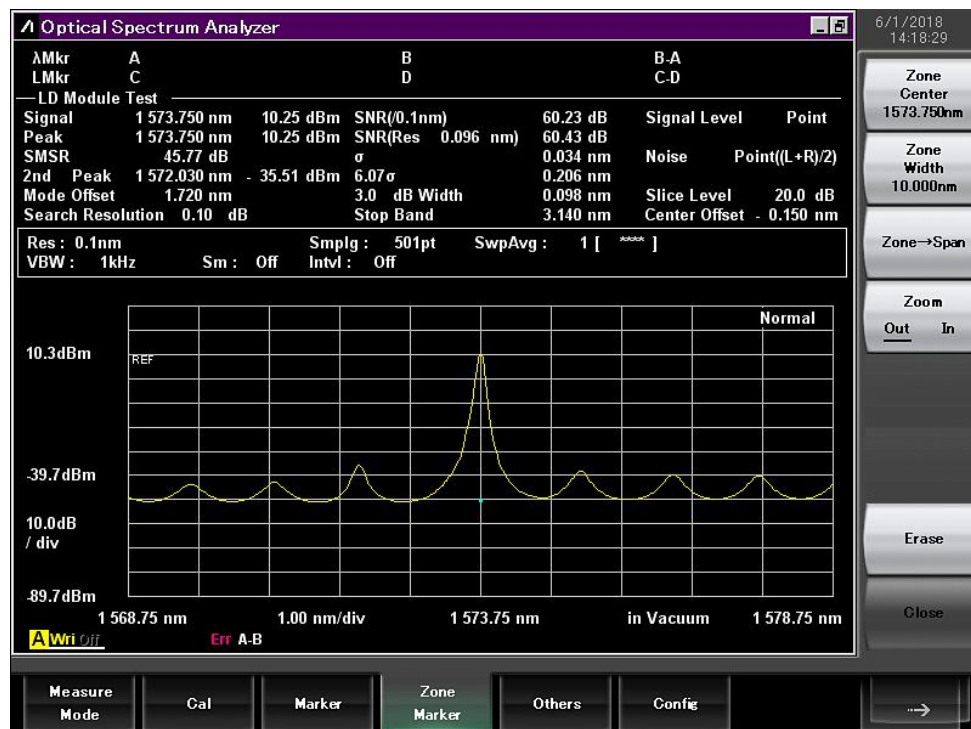

**Wavelength Stability**

30 mins Wavelength Stability

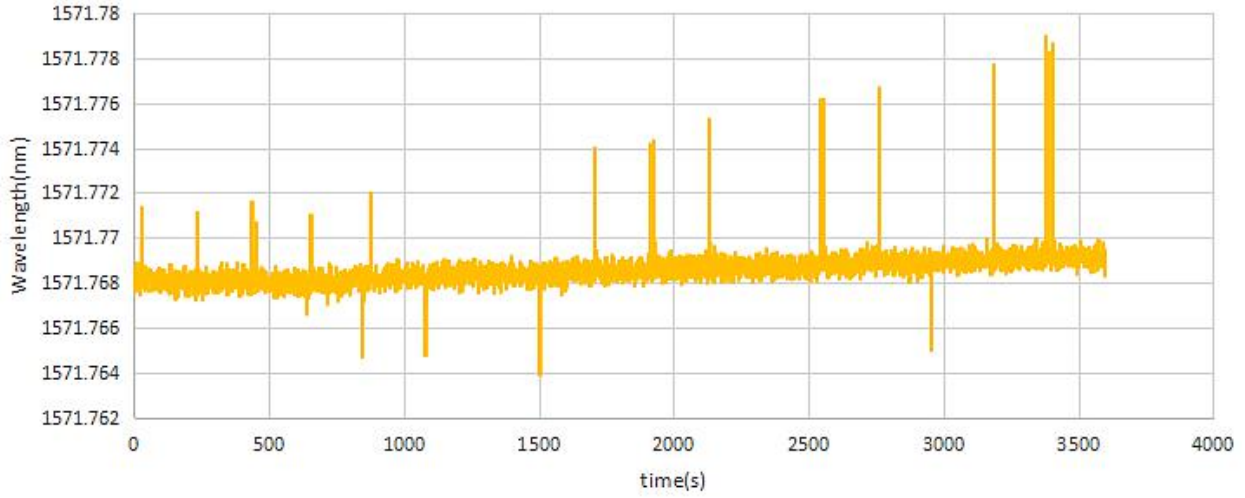

**L-I Curve**

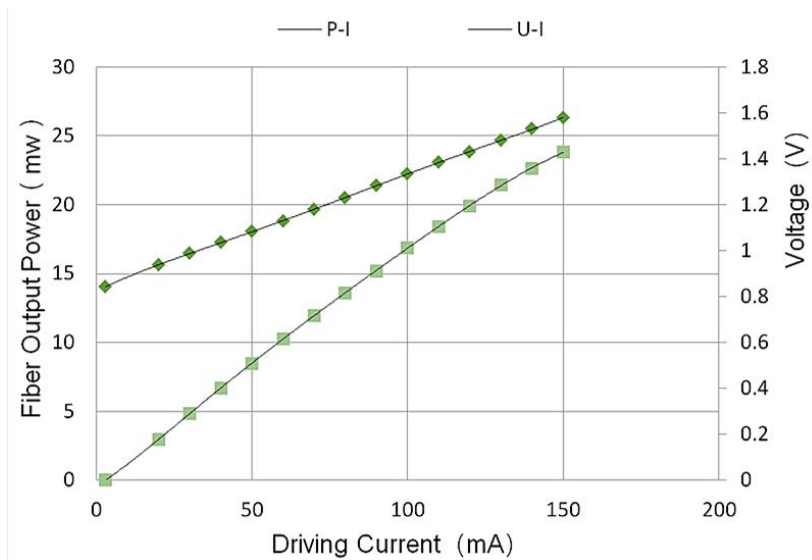

**Central Wavelength**

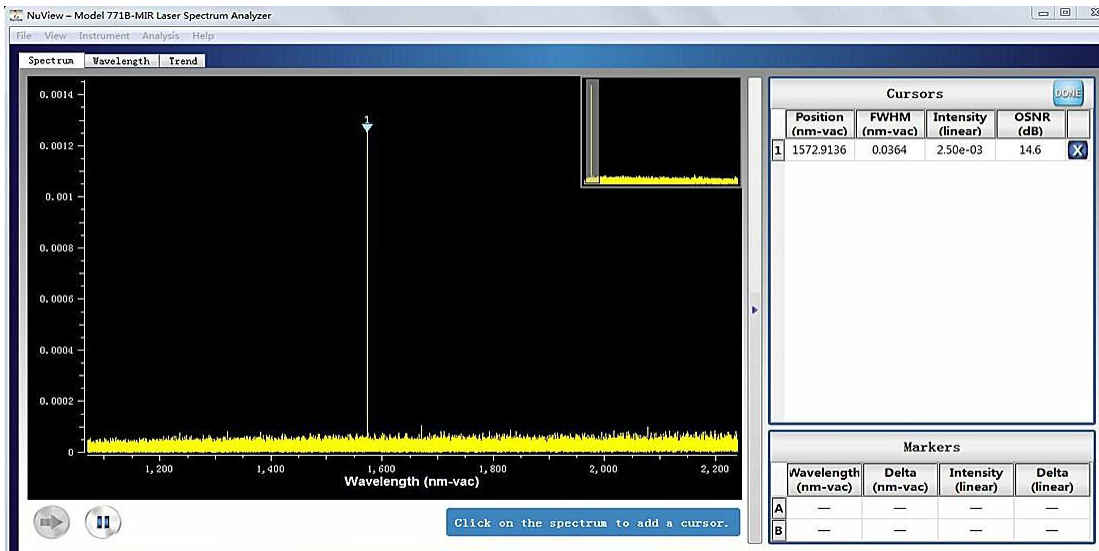

**DFB Linewidth Testing Result**

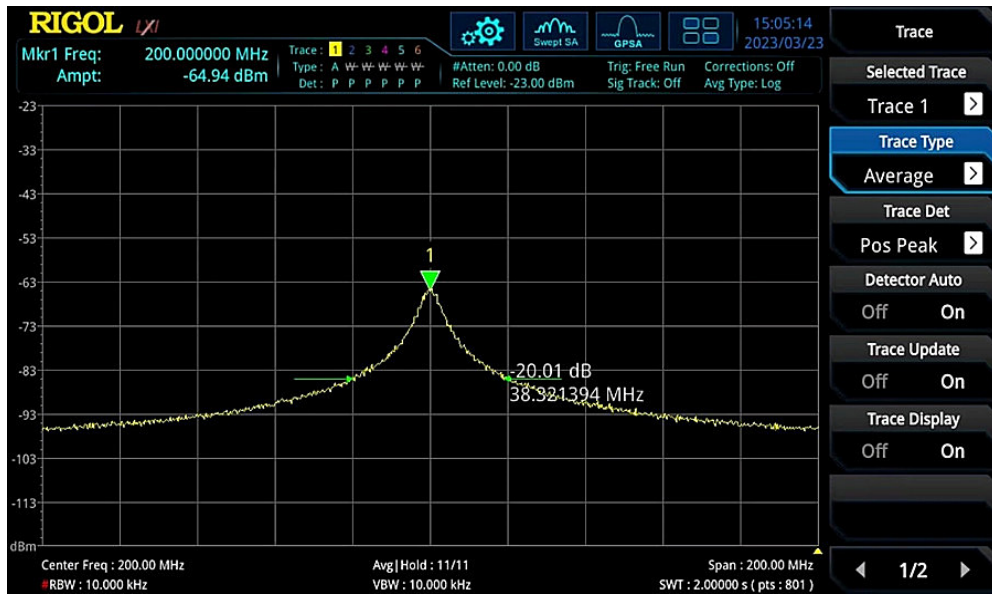

**Beam Quality**

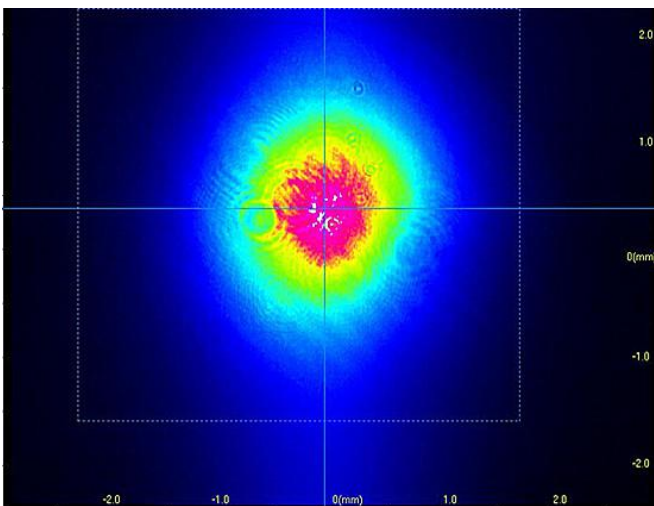

2D

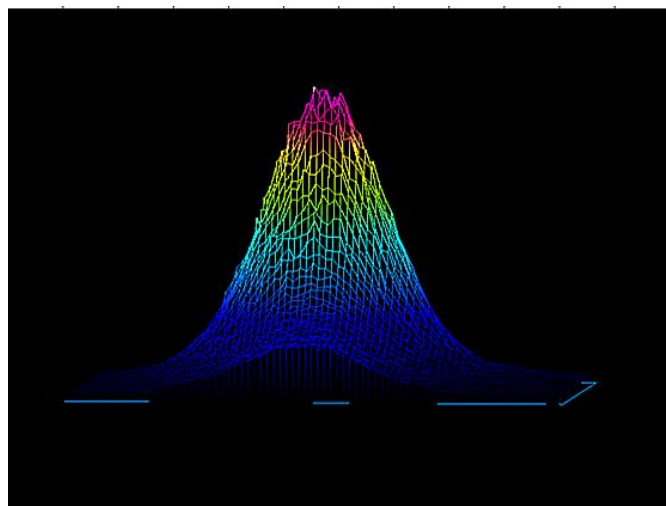

3D

**Camera Analysis**

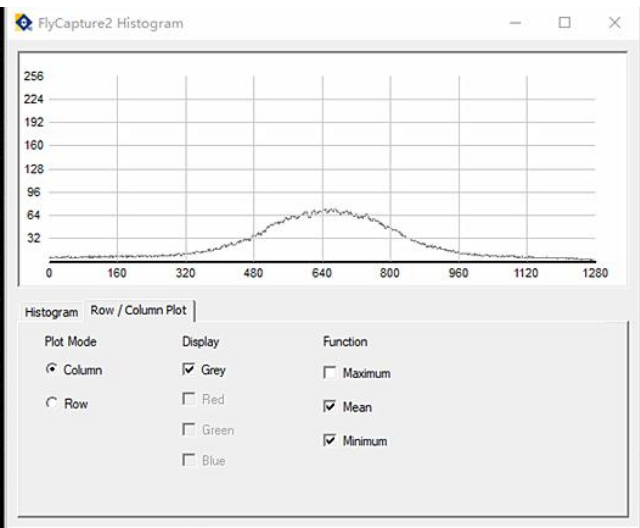
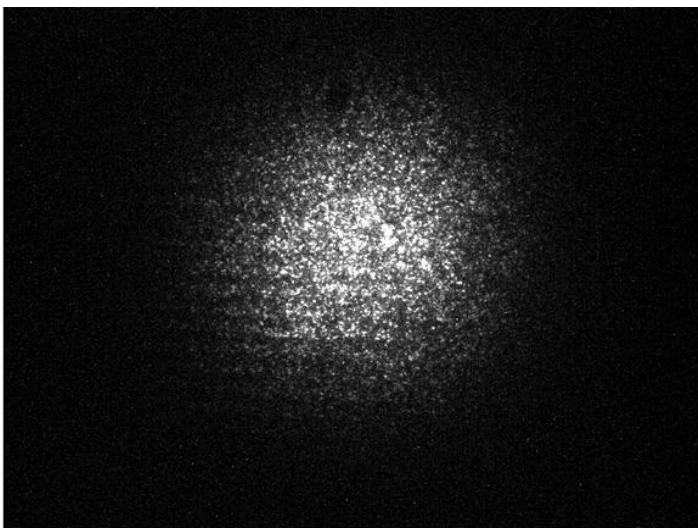

**Package Size**

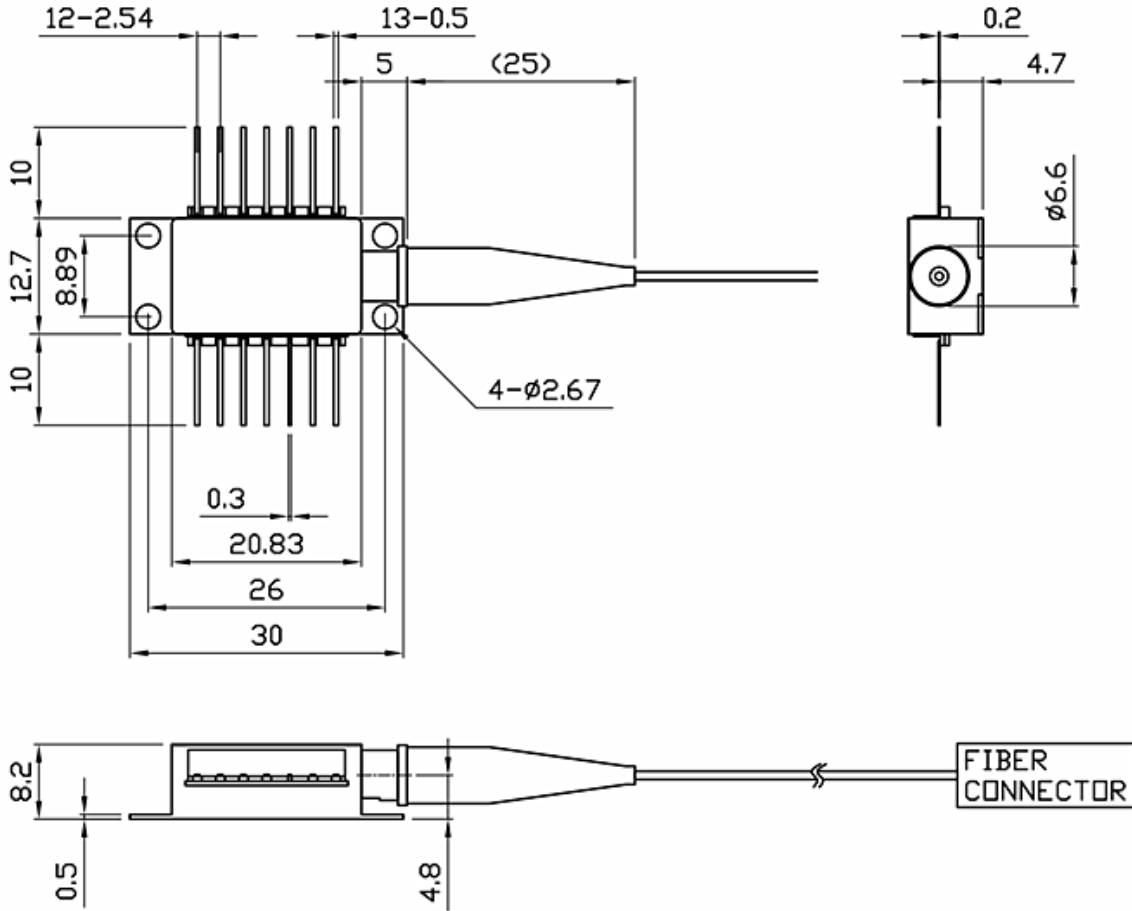

**Pin definition**

**Schematic Diagram (Top View)**

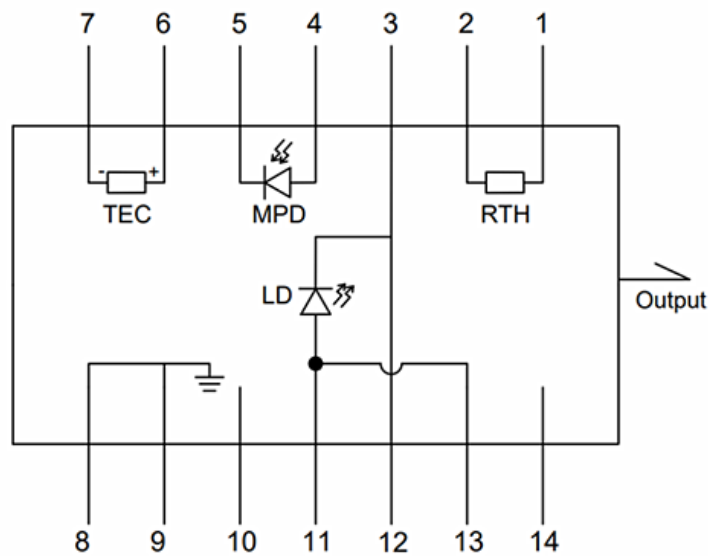

PIN#	Function	PIN#	Function
1	Thermistor	8	Case Ground
2	Thermistor	9	Case Ground
3	LD(-)	10	NC
4	Detector (+)	11	LD(+)
5	Detector (-)	12	LD (-), RF
6	TEC (+)	13	LD(+)
7	TEC (-)	14	NC

**Absolute Maximum Ratings**

Item	Unit	Min	Typ	Max
Case Temperature	°C	-5	25	70
Chip Temperature	°C	+10	25	40
Operating Current	mA	0	100	120
Forward Voltage	V	0.8	1.2	1.8
TEC Current	A	-	-	1.2
Reverse Voltage (LD)	V	-	-	2.0
Reverse Voltage (PD)	V	-	-	20

**CO<sub>2</sub>**

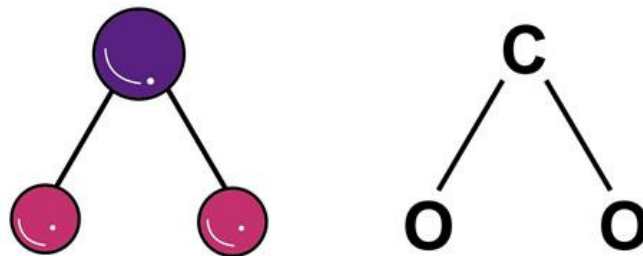
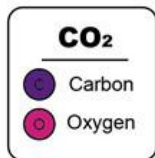

**TDLAS: 1572/1578/1580nm**

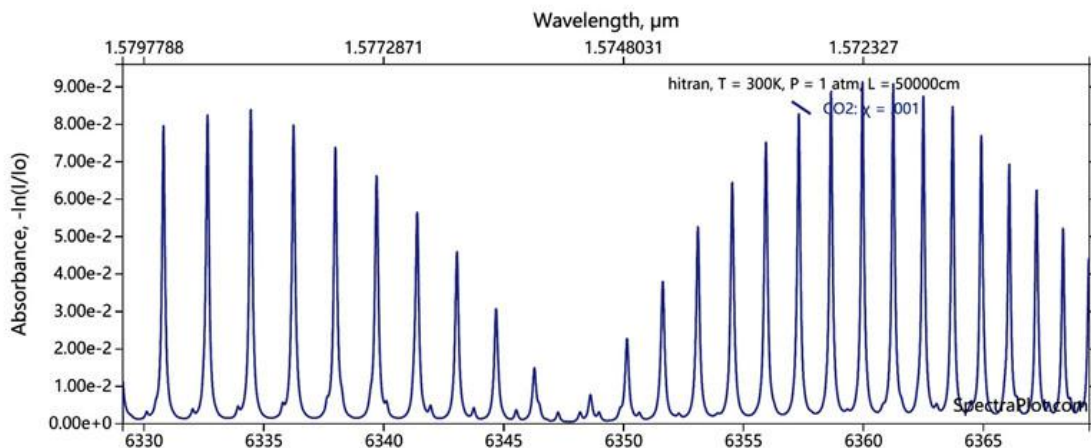

**Ordering Info****PL-DFB-□□□□-☆-▽- xx-14BF**

□□□□:Wavelength

1392:1392nm

1512:1512nm

1567:1567nm

1572:1572nm

\*\*\*\*\*

1653.7:1653.7nm

☆ :Output Power

A:10mW

B:20mW

▽:Wavelength Tolerance

1:±1nm

2:±2nm

XX: Fiber and Connector Type

SA=SMF-28E+ FC/APC

SP=SMF-28E+ FC/PC

PP=PM Fiber+ FC/PC

PA=PM Fiber+ FC/APC