

Features

- Ultra High Efficiency (Up to 96%)
- Full Power at Wide Output Current Range (Constant Power)
- Thermal Sensing and Protection for LED Module
- Isolated 0-10V/PWM/3-Timer-Modes Dimmable
- Dim-to-Off with Standby Power $\leq 2.5W$
- Output Lumen Compensation
- Input Surge Protection: DM 6kV, CM 10kV
- All-Around Protection: OVP, SCP, OTP
- IP67
- 5 Years Warranty



Description

The EFD-1K2SxxxDV series is a 1200W, constant-current, programmable LED driver that operates from 180-528Vac input with excellent power factor. Created for many lighting applications including high mast, sports, horticulture and aquaculture, etc, it provides a dim-to-off mode with low standby power. The high efficiency of these drivers and compact metal case enables them to run cooler, significantly improving reliability and extending product life. To ensure trouble-free operation, protection is provided against input surge, under voltage lock out, input over voltage, output over voltage, short circuit, and over temperature.

Models

Adjustable Output Current Range	Full-Power Current Range(1)	Default Output Current	Input Voltage Range(2)	Output Voltage Range	Max. Output Power	Typical Efficiency (3)	Typical Power Factor		Model Number
							277Vac	480Vac	
0.336-4.2A	3.36-4.20A	4.2A	180~528Vac/ 255~500Vdc	143~357Vdc	1200W	96.0%	0.96	0.95	EFD-1K2S420DV
0.448-5.60A	4.48~5.60A	5.6A	180~528Vac/ 255~500Vdc	108~268Vdc	1200W	95.5%	0.96	0.95	EFD-1K2S560DV
0.592-7.40A	5.92~7.4A	7.0 A	180~528Vac/ 255~500Vdc	81~202Vdc	1200W	95.0%	0.96	0.95	EFD-1K2S740DV

- Notes:** (1) Output current range with constant power at 1200W.
 (2) Certified voltage range: 200-480Vac or 255-500Vdc.
 (3) Measured at 100%load and 480Vac input (see below "General Specifications" for details).

I-V Operating Area

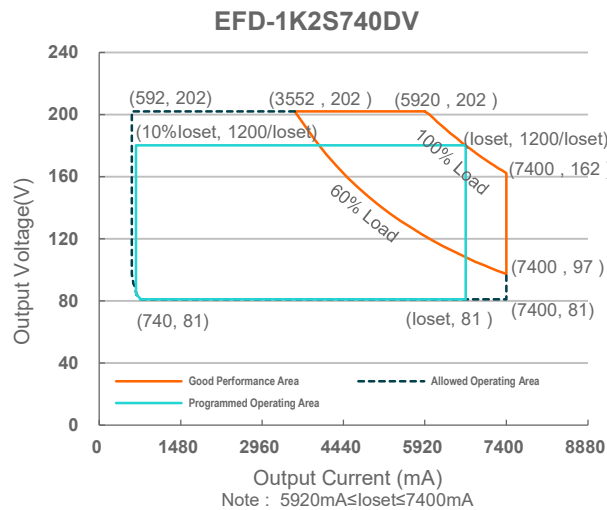
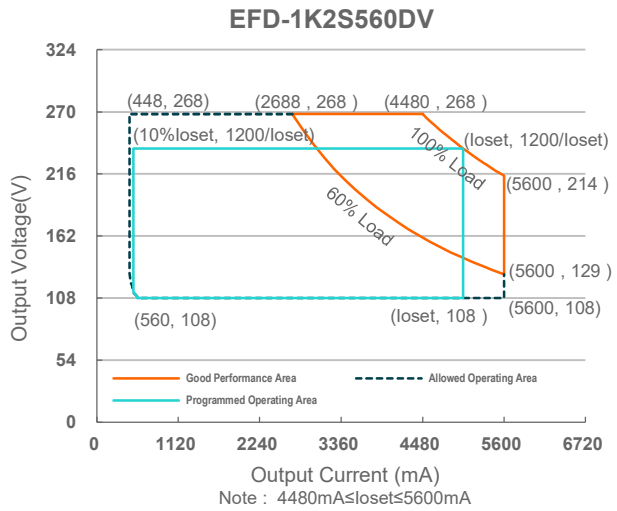
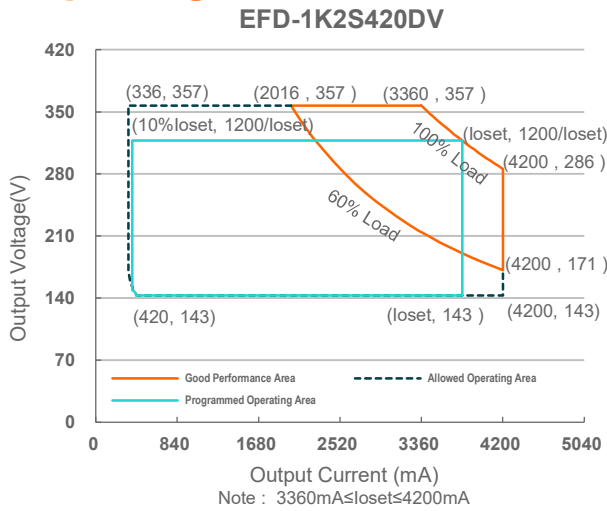

Input Specifications

Parameter	Min.	Typ.	Max.	Notes
Input AC Voltage	180 Vac	-	528 Vac	
Input DC Voltage	255 Vdc	-	500 Vdc	
Input Frequency	47 Hz	-	63 Hz	
Leakage Current	-	-	0.70 mA	IEC 60598-1; 480Vac/ 60Hz, grounding effectively
Input AC Current	-	-	5.5 A	Measured at 100%load and 240Vac input.
	-	-	4.7 A	Measured at 100%load and 277Vac input.
	-	-	2.7 A	Measured at 100%load and 480Vac input.

Input Specifications (Continued)

Parameter	Min.	Typ.	Max.	Notes
Inrush Current(I ² t)	-	-	37.5 A ² s	At 480Vac input, 25°C cold start, duration=1.18ms, 10%Ipk-10%Ipk. See Inrush Current Waveform for the details.
PF	0.90	-	-	At 200-480Vac, 50-60Hz, 60%-100% Load (720 – 1200W)
THD	-	-	20%	

Output Specifications

Parameter	Min.	Typ.	Max.	Notes
Output Current Tolerance	-5%loset	-	5%loset	100% load
Output Current Setting(loset) Range				
EFD-1K2S420DV	336 mA	-	4200 mA	
EFD-1K2S560DV	448 mA	-	5600 mA	
EFD-1K2S740DV	592 mA	-	7400 mA	
Output Current Setting Range with Constant Power				
EFD-1K2S420DV	3360 mA	-	4200 mA	
EFD-1K2S560DV	4480 mA	-	5600 mA	
EFD-1K2S740DV	5920 mA	-	7400 mA	
Total Output Current Ripple (pk-pk)	-	5%Iomax	10%Iomax	100%load , 20 MHz BW
Output Current Ripple at < 200 Hz (pk-pk)	-	2%Iomax	-	100%load
Startup Overshoot Current	-	-	10%Iomax	100%load
No Load Output Voltage				
EFD-1K2S420DV	-	-	390 V	
EFD-1K2S560DV	-	-	300 V	
EFD-1K2S740DV	-	-	230 V	
Line Regulation	-	-	±0.5%	100%load
Load Regulation	-	-	±1.5%	
Turn-on Delay Time	-	-	0.75 s	Measured at 200-480Vac input, 60%-100% Load
Temperature Coefficient of loset	-	0.03%/°C	-	Case temperature = 0°C ~Tc max
12V Auxiliary Output Voltage	10.8 V	12 V	13.2 V	
12V Auxiliary Output Source Current	0 mA	-	200 mA	Return terminal is "Dim"

General Specifications

Parameter	Min.	Typ.	Max.	Notes				
Efficiency at 240 Vac input: EFD-1K2S420DV lo= 3360 mA lo= 4200 mA EFD-1K2S560DV lo= 4480 mA lo= 5600 mA EFD-1K2S740DV lo= 5920 mA lo= 7400 mA	91.5% 91.5% 91.5% 91.0% 91.0% 91.0%	93.5% 93.5% 93.5% 93.0% 93.0% 93.0%	- - - - - -	Measured at 100% load and steady-state temperature in 25°C ambient; (Efficiency will be about 2.0% lower if measured immediately after startup.)				
Efficiency at 277 Vac input: EFD-1K2S420DV lo= 3360 mA lo= 4200 mA EFD-1K2S560DV lo= 4480 mA lo= 5600 mA EFD-1K2S740DV lo= 5920 mA lo= 7400 mA	92.5% 92.0% 92.0% 91.5% 92.0% 91.5%	94.5% 94.0% 94.0% 93.5% 94.0% 93.5%	- - - - - -		Measured at 100% load and steady-state temperature in 25°C ambient; (Efficiency will be about 2.0% lower if measured immediately after startup.)			
Efficiency at 347 Vac input: EFD-1K2S420DV lo= 3360 mA lo= 4200 mA EFD-1K2S560DV lo= 4480 mA lo= 5600 mA EFD-1K2S740DV lo= 5920 mA lo= 7400 mA	93.0% 93.0% 93.0% 92.5% 93.5% 92.0%	95.0% 95.0% 95.0% 94.5% 94.5% 94.0%	- - - - - -			Measured at 100% load and steady-state temperature in 25°C ambient; (Efficiency will be about 2.0% lower if measured immediately after startup.)		
Efficiency at 480 Vac input: EFD-1K2S420DV lo= 3360 mA lo= 4200 mA EFD-1K2S560DV lo= 4480 mA lo= 5600 mA EFD-1K2S740DV lo= 5920 mA lo= 7400 mA	94.0% 93.0% 93.5% 93.0% 93.0% 92.5%	96.0% 95.0% 95.5% 95.0% 95.0% 94.5%	- - - - - -				Measured at 100% load and steady-state temperature in 25°C ambient; (Efficiency will be about 2.0% lower if measured immediately after startup.)	
Standby power	-	-	2.5 W					Measured at 480Vac/50Hz; Dimming off
MTBF	-	212,000 Hours	-					Measured at 480Vac input, 80%load and 25°C ambient temperature (MIL-HDBK-217F)
Lifetime	-	100,000 Hours	-	Measured at 480Vac input, 80%load and 70°C case temperature; See lifetime vs. Tc curve for the details				
Operating Case Temperature for Safety Tc_s	-40°C	-	+90°C					
Operating Case Temperature for Warranty Tc_w	-40°C	-	+75°C	Case temperature for 5 years warranty Humidity: 10%RH to 95%RH				
Storage Temperature	-40°C	-	+85°C	Humidity: 5%RH to 95%RH				

General Specifications (Continued)

Parameter	Min.	Typ.	Max.	Notes
Dimensions Inches (L × W × H) Millimeters (L × W × H)	11.02 × 6.89 × 2.99 280 × 175 × 76			With mounting ear 11.02 × 9.06 × 2.99 280 × 230 × 76
Net Weight	-	6570 g	-	

Dimming Specifications

Parameter	Min.	Typ.	Max.	Notes	
Absolute Maximum Voltage on the Vdim (+) Pin	-20 V	-	20 V		
Source Current on Vdim (+) Pin	200 μA	300 μA	450 μA	Vdim(+) = 0 V	
Dimming Output Range	EFD-1K2S420DV EFD-1K2S560DV EFD-1K2S740DV	10%loset	-	loset	3360mA ≤ loiset ≤ 4200mA 4480mA ≤ loiset ≤ 5600mA 5920mA ≤ loiset ≤ 7400mA
	EFD-1K2S420DV EFD-1K2S560DV EFD-1K2S740DV	336 mA 448 mA 592 mA	-	loset	336mA ≤ loiset < 3360mA 448mA ≤ loiset < 4480mA 592mA ≤ loiset < 5920mA
	Recommended Dimming Input Range	0 V	-	10 V	Default 0-10V dimming mode.
Dim off Voltage	0.35 V	0.5 V	0.65 V		
Dim on Voltage	0.55 V	0.7 V	0.85 V		
Hysteresis	-	0.2 V	-		
PWM_in High Level	3 V	-	10 V	Dimming mode set to PWM in Inventronics Programing Software.	
PWM_in Low Level	-0.3 V	-	0.6 V		
PWM_in Frequency Range	200 Hz	-	1KHz		
PWM_in Duty Cycle	1%	-	99%		
PWM Dimming off (Positive Logic)	3%	5%	8%		
PWM Dimming on (Positive Logic)	5%	7%	10%		
PWM Dimming off (Negative Logic)	92%	95%	97%		
PWM Dimming on (Negative Logic)	90%	93%	95%		
Hysteresis	-	2%	-		

Safety & EMC Compliance

Safety Category	Standard
ENEC & CE ⁽¹⁾	EN 61347-1, EN 61347-2-13
CB	IEC 61347-1, IEC 61347-2-13
CCC	GB 19510.1, GB 19510.14

Safety & EMC Compliance (Continued)

Safety Category	Standard
PSE	J 61347-1, J 61347-2-13
KC	K 61347-1, K 61347-2-13
Performance	Standard
ENEC	EN IEC 62384
EMI Standards	Notes
EN IEC 55015/GB/T 17743/KS C 9815 ⁽²⁾	Conducted emission Test & Radiated emission Test
EN IEC 61000-3-2/GB 17625.1	Harmonic current emissions
EN 61000-3-3	Voltage fluctuations & flicker
EMS Standards	Notes
EN 61000-4-2	Electrostatic Discharge (EFD): 8 kV air discharge, 4 kV contact discharge
EN 61000-4-3	Radio-Frequency Electromagnetic Field Susceptibility Test-RS
EN 61000-4-4	Electrical Fast Transient / Burst-EFT
EN 61000-4-5	Surge Immunity Test: AC Power Line: Differential Mode 6 kV, Common Mode 10 kV ⁽³⁾
EN 61000-4-6	Conducted Radio Frequency Disturbances Test-CS
EN 61000-4-8	Power Frequency Magnetic Field Test
EN 61000-4-11	Voltage Dips
EN 61547/KS C 9547	Electromagnetic Immunity Requirements Applies To Lighting Equipment

Note: (1) For compliance with EU Directive 2009/125/EC (eco-design requirements for energy-related products) the Dim-to-Off function shall not be used or alternatively be interrupted through use of a relay or similar device to prevent excessive standby power consumption.

(2) This LED driver meets the EMI specifications above, but EMI performance of a luminaire that contains it depends also on the other devices connected to the driver and on the fixture itself.

(3) To perform electric strength (hi-pot) testing, the "GDT ground disconnect" (nut and metal lock sheet) on the driver end-cap should be removed temporarily to prevent the internal gas discharge tube from conducting (as allowed by IEC 60598-1 Clause 10.2). After testing is completed, these items must be reinstalled to restore line-to-earth surge protection and secure the end cap.

Derating

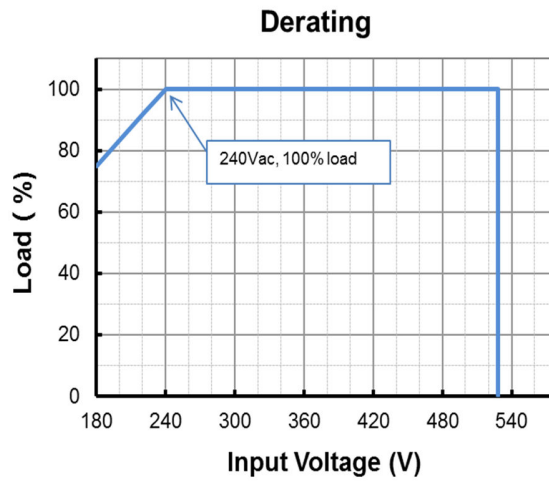

Lifetime vs. Case Temperature

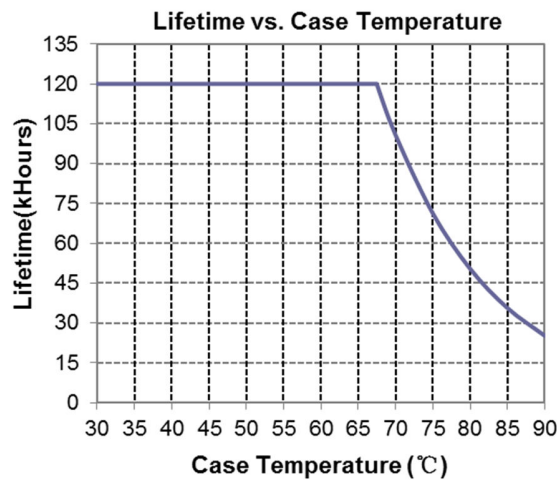

Inrush Current Waveform

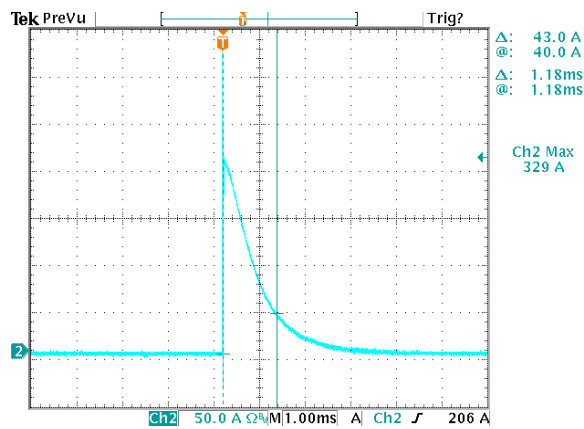

Efficiency vs. Load

EFD-1K2S420DV($I_o=3360mA$)
Efficiency vs. Output Voltage

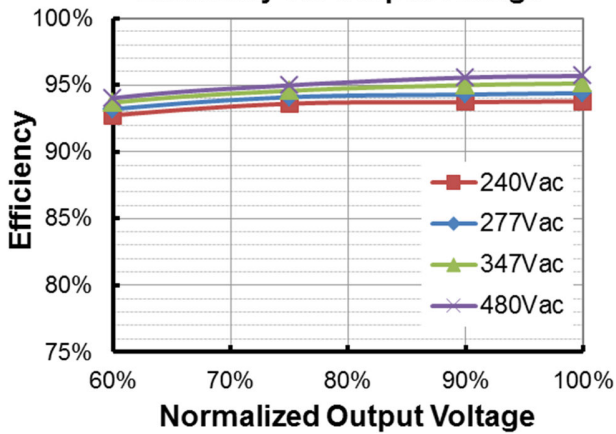

EFD-1K2S420DV($I_o=4200mA$)
Efficiency vs. Output Voltage

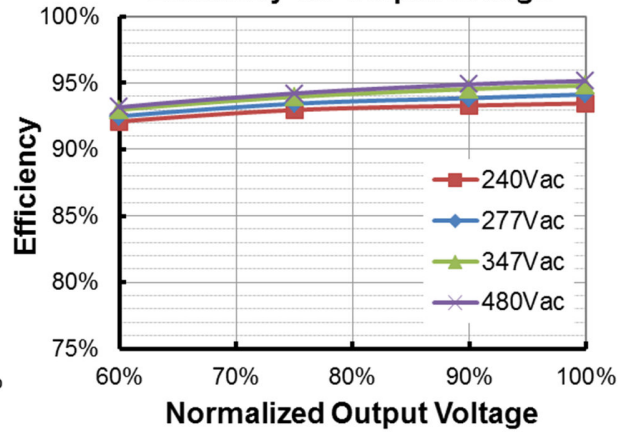

EFD-1K2S560DV($I_o=4480mA$)
Efficiency vs. Output Voltage

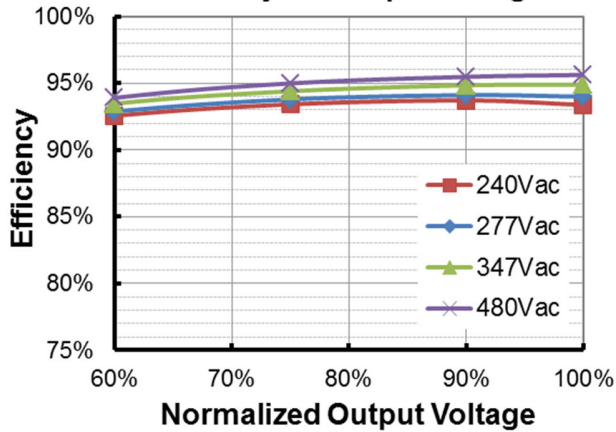

EFD-1K2S560DV($I_o=5600mA$)
Efficiency vs. Output Voltage

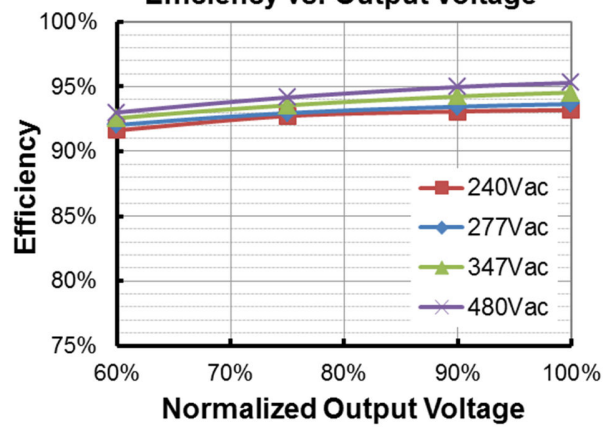

EFD-1K2S740DV($I_o=5920mA$)
Efficiency vs. Output Voltage

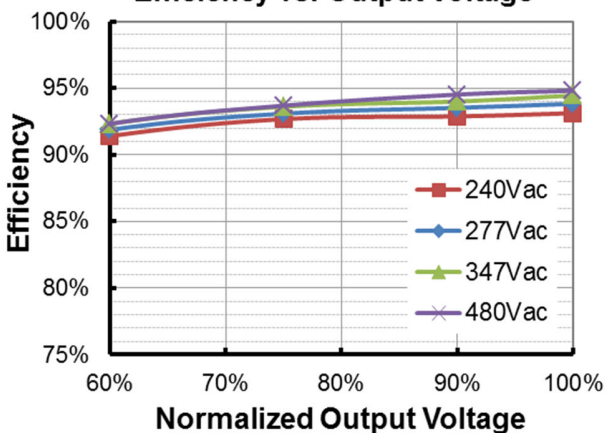

EFD-1K2S740DV($I_o=7400mA$)
Efficiency vs. Output Voltage

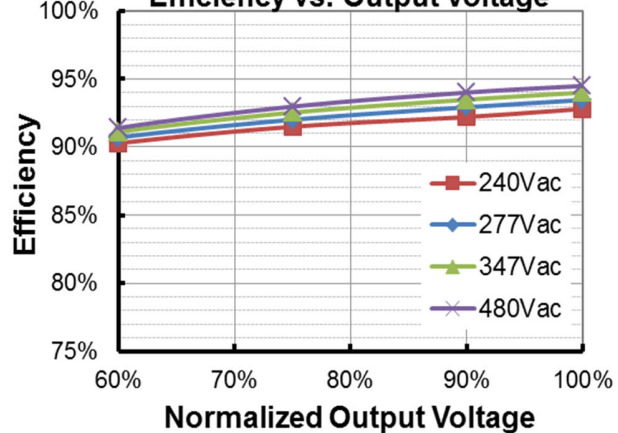

Power Factor

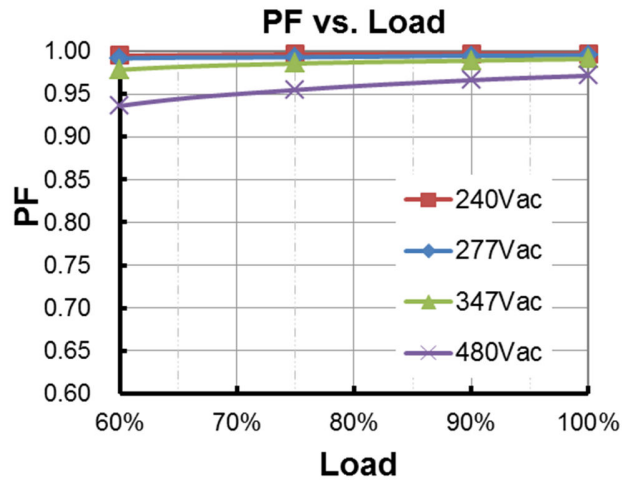

Total Harmonic Distortion

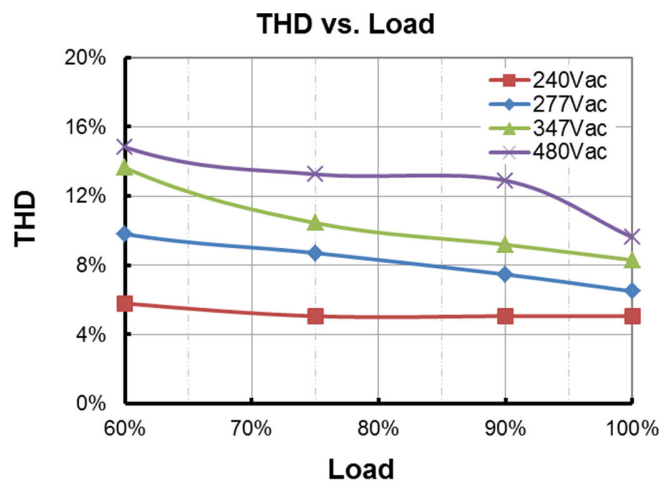

Protection Functions

Parameter		Min.	Typ.	Max.	Notes
External Thermal Protection NTC	R1	-	7.81 kOhm	-	When R_NTC falls below R1, External Thermal Protection is triggered, reducing output current until R2 is reached.
	R2	-	4.16 kOhm	-	When R_NTC is less than R2, output current is reduced to the programmed "Protection Current Floor."
	Protection Current Floor	10%loset	60%loset	100%loset	10%loset > lomin (default setting is 60%)
		lomin	60%loset	100%loset	10%loset ≤ lomin (default setting is 60%)
Over Temperature Protection		Decreases output current, returning to normal after over temperature is removed.			
Short Circuit Protection		Auto Recovery. No damage will occur when any output is short circuited. The output shall return to normal when the fault condition is removed.			
Over Voltage Protection		Limits output voltage at no load and in case the normal voltage limit fails.			

Dimming

● 0-10V Dimming

The recommended implementation of the dimming control is provided below.

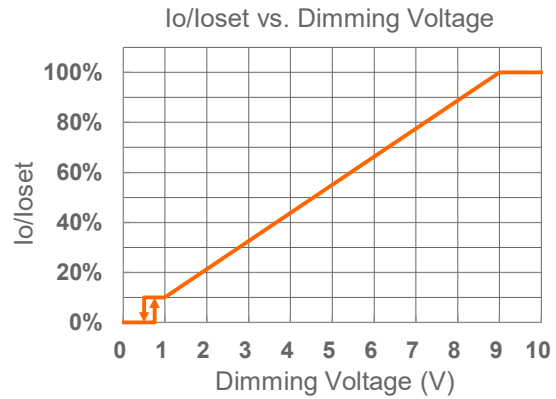
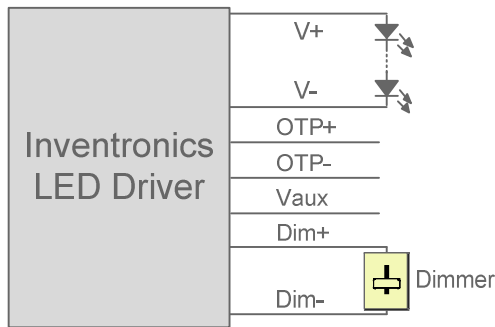

Implementation 1: DC Input

Notes:

1. Do NOT connect Dim- to the output V- or V+, otherwise the driver will not work properly.
2. The dimmer can also be replaced by an active 0-10V voltage source signal or passive components like zener.

● PWM Dimming

The recommended implementation of the dimming control is provided below.

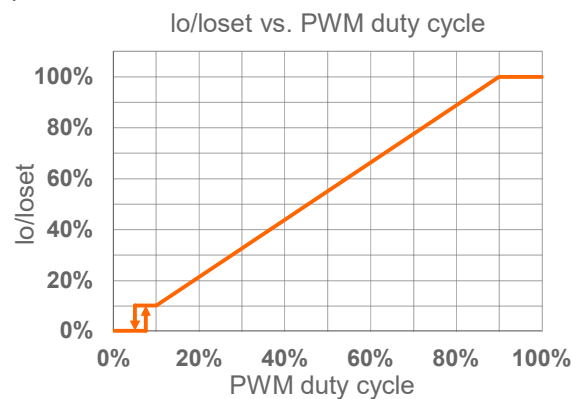
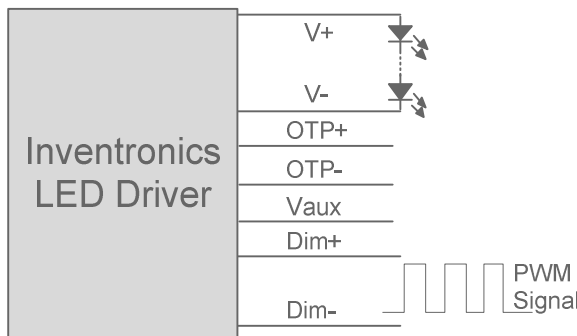

Implementation 2: Positive logic

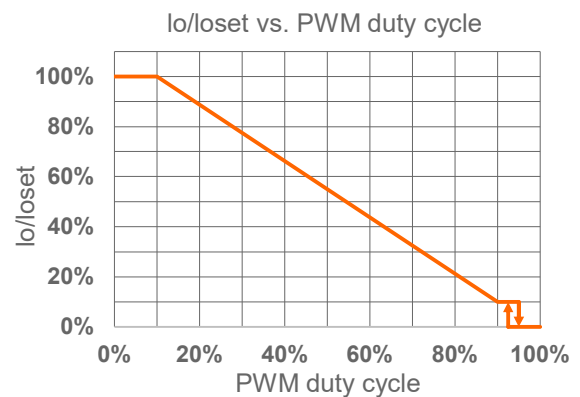
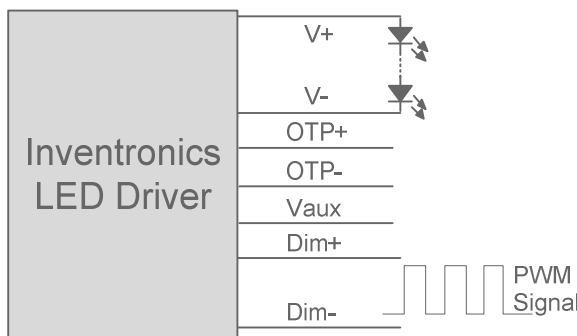

Implementation 3: Negative logic

Notes:

1. Do NOT connect Dim- to the output V- or V+, otherwise the driver will not work properly.
2. When PWM negative logic dimming mode and Dim+ is open, the driver will dim to off and be standby.

● **Time Dimming**

Time dimming control includes 3 kinds of modes, they are Self Adapting-Midnight, Self Adapting-Percentage and Traditional Timer.

- **Self Adapting-Midnight:** Automatically adjusts the dimming curve based on the on-time of past two days (if difference <15 minutes), assuming that the center point of the dimming curve is midnight local time.
- **Self Adapting-Percentage:** Automatically adjusts the on-time of each step by a constant percentage = (actual on-time for the past 2 days if difference <15 min) / (programmed on-time from the dimming curve).
- **Traditional Timer:** Follows the programmed timing curve after power on with no changes.

● **0% Light Brightness**

If the brightness of the LED lighting fixture down to 0%, please refer to the following wiring method. The lamp can be turned on/off using a switch and relay.

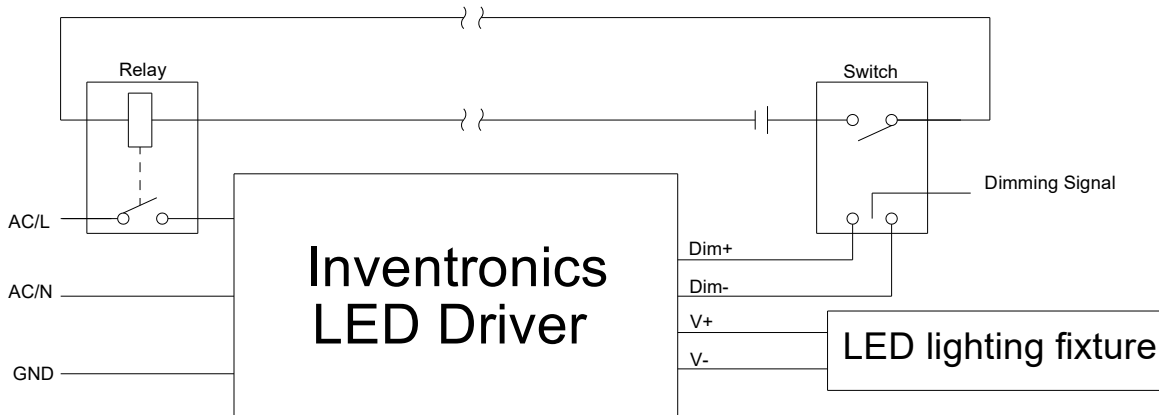

● **Output Lumen Compensation**

Output Lumen Compensation (OLC) may be used to maintain constant light output over the life of the LEDs by driving them at a reduced current when new, then gradually increasing the drive current over time to counteract LED lumen degradation.

Programming Connection Diagram

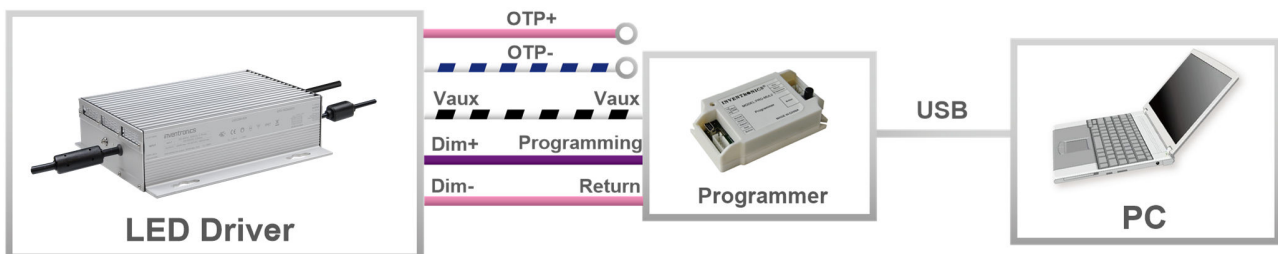

Note: The driver does not need to be powered on during the programming process.

● Please refer to [PRG-MUL2 \(Programmer\) datasheet](#) for details.

Mechanical Outline

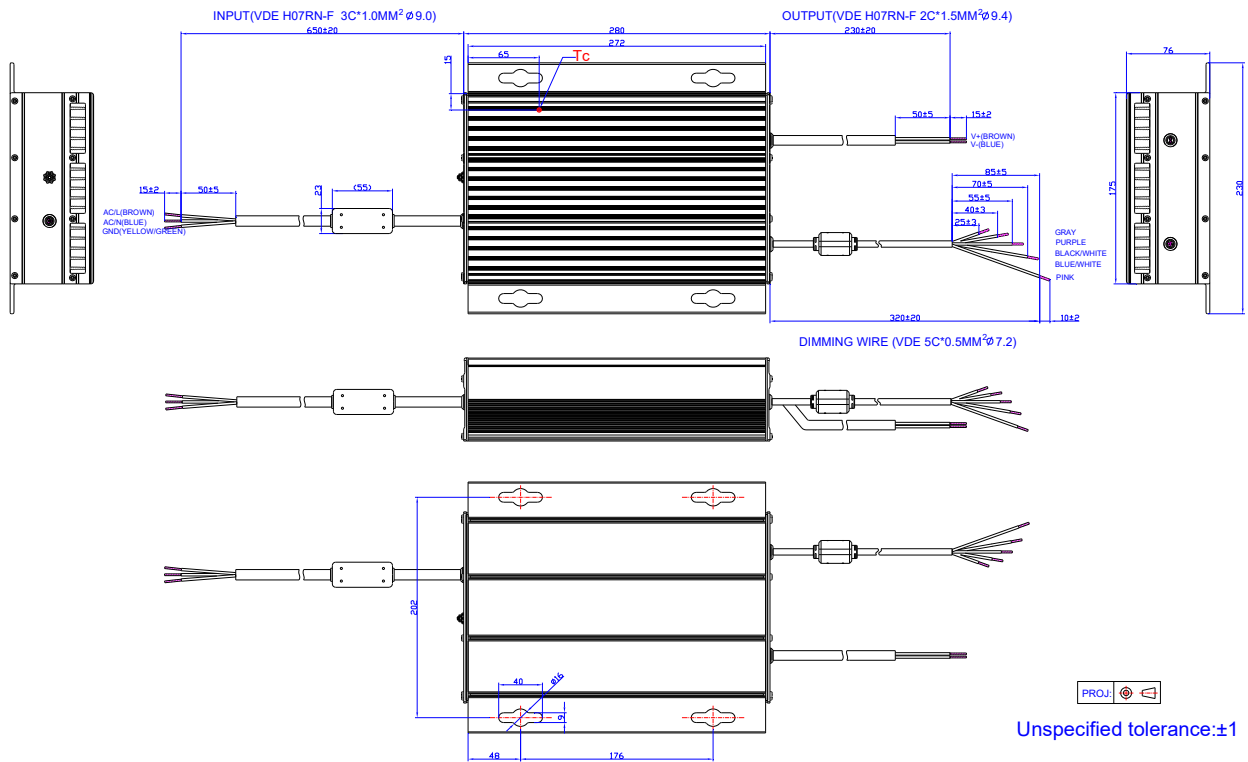

RoHS Compliance

Our products comply with reference to RoHS Directive (EU) 2015/863 amending 2011/65/EU, calling for the elimination of lead and other hazardous substances from electronic products.

Revision History

Change Date	Rev.	Description of Change		
		Item	From	To
2018-03-12	A	Datasheet Release	/	/
2018-03-16	B	Programming Connection Diagram	/	Updated
2018-03-21	C	Features	Dim-to-Off with Standby Power ≤ 2.4 W	Dim-to-Off with Standby Power ≤ 2.5 W
		Standby power	2.4 W	2.5 W
2018-04-25	D	PSE	/	Updated
		Models	/	Updated
2019-12-02	E	CCC Logo	/	Updated
		PSE Logo	/	Updated
		EAC Logo	/	Added
		Independent Logo	/	Added
		Features	0-10V/PWM/Timer Dimmable (3 Timer Modes, Isolated design)	Isolated 0-10V/PWM/3-Timer Modes Dimmable
		Features	6kV line-line, 10kV line-earth	DM 6kV, CM 10kV
		Features	Waterproof (IP67)	IP67
		Features	Suitable for Independent Use	Deleted
		Safety & EMC Compliance	ENEC	Added
		Safety & EMC Compliance	TUV	Added
		Safety & EMC Compliance	CB	Added
		Safety & EMC Compliance	PSE	Added
		Safety & EMC Compliance	KC	Added
		Safety & EMC Compliance	EAC	Added
		Safety & EMC Compliance	EN 55015 ⁽¹⁾	EN 55015/GB 17743/KN 15 ⁽¹⁾
		Safety & EMC Compliance	EN 61000-3-2	EN 61000-3-2/GB 17625.1
		Safety & EMC Compliance	EN 61000-4-5	Updated
RoHS Compliance	/	Updated		
2021-10-22	F	Safety & EMC Compliance	Note(1)	Added
		Dimming	0% Light Brightness	Added
2023-07-05	G	TUV logo	/	Deleted
		UKCA logo	/	Added
		Safety & EMC Compliance	/	Updated

Revision History (Continued)

Change Date	Rev.	Description of Change		
		Item	From	To
2023-07-05	G	Programming Connection Diagram	/	Updated
2025-01-09	H	Format	/	Updated
		Product Photograph	/	Updated
		EAC Logo	/	Deleted
		Safety &EMC Compliance	/	Updated