

**Harvatek Surface Mount CHIP LEDs Data Sheet  
B2972USUG20D000114E0118**

Official Product	HT Part No. B2972USUG20D000114E0118		
Tentative Product	*****	*****	*****
Specifications are subject to changes for improvement without advance notice. Proprietary data, drawings, company confidential all rights reserved.		05/20/2024	Version 1.6 Page 1/14

<b>DISCLAIMER</b> .....	<b>3</b>
<b>LIFE SUPPORT POLICY</b> .....	<b>3</b>
<b>PRODUCT SPECIFICATIONS</b> .....	<b>4</b>
<b>ATTENTION: ELECTROSTATIC DISCHARGE (ESD) PROTECTION</b> .....	<b>4</b>
<b>LABEL SPECIFICATIONS</b> .....	<b>5</b>
<b>SPECIFICATIONS RANGE</b> .....	<b>6</b>
<b>PRODUCT FEATURES</b> .....	<b>7</b>
<b>ELECTRO-OPTICAL CHARACTERISTICS</b> .....	<b>7</b>
<b>PACKAGE OUTLINE DIMENSION AND RECOMMENDED SOLDERING PATTERN FOR REFLOW</b>	
<b>SOLDERING</b> .....	<b>7</b>
<b>ABSOLUTE MAXIMUM RATINGS</b> .....	<b>7</b>
<b>CHARACTERISTICS OF B2972USUG</b> .....	<b>8</b>
<b>PRECAUTION FOR USE</b> .....	<b>9</b>
<b>PACKAGING</b> .....	<b>10</b>
<b>TAPE DIMENSION</b> .....	<b>10</b>
<b>REEL DIMENSION</b> .....	<b>11</b>
<b>PACKING</b> .....	<b>11</b>
<b>DRY PACK</b> .....	<b>12</b>
<b>BAKING</b> .....	<b>12</b>
<b>PRECAUTIONS</b> .....	<b>12</b>
<b>REFLOW SOLDERING</b> .....	<b>13</b>
<b>REWORKING</b> .....	<b>13</b>
<b>CLEANING</b> .....	<b>13</b>
<b>CAUTIONS OF PICK AND PLACE</b> .....	<b>14</b>
<b>REVISE HISTORY</b> .....	<b>14</b>

Official Product	HT Part No. B2972USUG20D000114E0118		
Tentative Product	*****	*****	
Specifications are subject to changes for improvement without advance notice. Proprietary data, drawings, company confidential all rights reserved.		05/20/2024	Version 1.6 Page 2/14

## DISCLAIMER

HARVATEK reserves the right to make changes without further notice to any products herein to improve reliability, function or design. HARVATEK does not assume any liability arising out of the application or use of any product or circuit described herein; neither does it convey any license under its patent rights, nor the rights of others.

## Life Support Policy

HARVATEK's products are not authorized for use as critical components in life support devices or systems without the express written approval of the President of HARVATEK or HARVATEK INTERNATIONAL. As used herein:

1. Life support devices or systems are devices or systems which, (a) are intended for surgical implant into the body, or (b) support or sustain life, and (c) whose failure to perform when properly used in accordance with instructions for use provided in the labeling, can be reasonably expected to result in a significant injury of the user.
2. A critical component in any component of a life support device or system whose failure to perform can be reasonably expected to cause the failure of the life support device or system, or to affect its safety or effectiveness.

Official Product	HT Part No. B2972USUG20D000114E0118		
Tentative Product	*****	*****	*****
Specifications are subject to changes for improvement without advance notice. Proprietary data, drawings, company confidential all rights reserved.	05/20/2024	Version 1.6	Page 3/14

## Product Specifications

Item	Specification	Material	Quantity
Luminous Intensity(Iv)	US:45.0-180.0 mcd UG:28.5-180.0 mcd @20mA/ T <sub>s</sub> = 25°C;Tolerance: ± 10%		
Wavelength	US:615.0-630.0 nm UG:567.5-579.5 nm @20mA/ T <sub>s</sub> = 25°C;Tolerance: ± 0.5nm		
Vf	US:1.6-2.4V UG:1.6-2.4V @20mA/ T <sub>s</sub> = 25°C ;Tolerance: ± 0.05V		
Ir	< 10 μA @ V <sub>R</sub> = 5 V		
Resin	Diffused	Epoxy	
Carrier tape	EIA 481-1A specs	Conductive black tape	
Reel	EIA 481-1A specs	Conductive black	
Label	HT standard	Paper	
Packing bag	250x230mm	Aluminum laminated bag/ no-zipper	One reel per bag
Carton	HT standard	Paper	Non-specified

**Others:**

Each immediate box consists of 5 reels. The 5 reels may not necessarily have the same lot number or the same bin combinations of I<sub>v</sub>, λ<sub>D</sub> and V<sub>f</sub>. Each reel has a label identifying its specification; the immediate box consists of a product label as well.

Note :This is shipped test conditions

※Remarks: This product should be operated in forward bias. If a reverse voltage is continuously applied to the product, such operation can cause migration resulting in LED damage.

**ATTENTION: Electrostatic Discharge (ESD) protection**



The symbol to the left denotes that ESD precaution is needed. ESD protection for GaP and AlGaAs based chips is necessary even though they are relatively safe in the presence of low static-electric discharge. Parts built with AlGaInP, GaN, or/and InGaN based chips are **STATIC SENSITIVE devices**. ESD precaution must be taken during design and assembly.

If manual work or processing is needed, please ensure the device is adequately protected from ESD during the process.

Official Product	HT Part No. B2972USUG20D000114E0118		
Tentative Product	*****	*****	*****
Specifications are subject to changes for improvement without advance notice. Proprietary data, drawings, company confidential all rights reserved.	05/20/2024	Version 1.6	Page 4/14

## Label Specifications

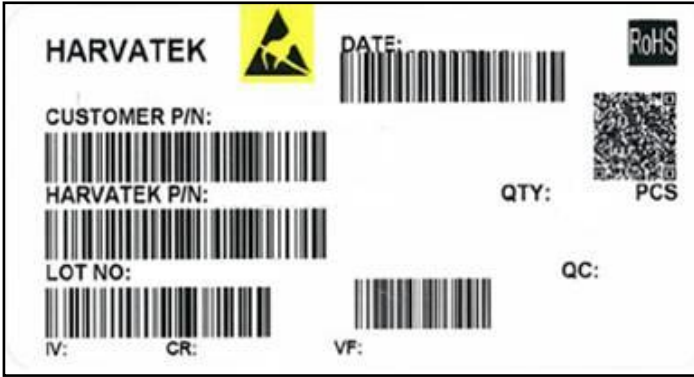

■ Harvatek P/N:

**B            297            2            USUG            20D-            0001            14**

Product	Package	Dice Q'ty	Color	Current	Series Number	Taping
PCB	1.6(L)x0.8(W)x0.5(H) mm	2: Bi	US: Ultra Bright Red UG: Ultra Bright Yellow Green	20mA	X001~XZZZ	1. Taping style 2. Q'ty

■ Lot No.:

1	2	3	4	5	6	7	8	9	10
<b>E</b>	<b>1</b>	<b>A</b>	<b>1</b>	<b>A</b>	<b>2</b>	<b>2</b>	<b>L</b>	<b>1</b>	<b>2</b>
Code 1 2		Code 3	Code 4	Code 5	Code 6	Code 7	Code 8	Code 9	Code 10
		Mfg. Year	Mfg. Month	Mfg. Date	Consecutive number		Special code		
Internal Tracing Code		2020-L 2021-M 2022-P 2023-Q ... 2026-T 2027-V ... 2030-Y 2031-Z ...	1:Jan. 2:Feb. ... ... A:Oct. B:Nov. C:Dec.	1:A 2:B 3:C ... 26:Z 27:7 28:8 29:9 30:3 31:4	01~ZZ		000~ZZZ		

Official Product	HT Part No. B2972USUG20D000114E0118		
Tentative Product	*****	*****	*****
Specifications are subject to changes for improvement without advance notice. Proprietary data, drawings, company confidential all rights reserved.		05/20/2024	Version 1.6    Page 5/14

## Specifications Range

### ■ Luminous Intensity (Iv) Bin:

Color	Bin Code	Spec. Range
US	P	45.00-71.50 mcd
	Q	71.50-112.5 mcd
	R	112.5-180.0 mcd
UG	N	28.50-45.00 mcd
	P	45.00-71.50 mcd
	Q	71.50-112.5 mcd
	R	112.5-180.0 mcd

Note: It maintains a tolerance of  $\pm 10\%$  on luminous intensity

### ■ Wavelength Bin:

Color	Bin Code	Spec. Range
US	AC	615.0-630.0 nm
UG	C	567.5-570.5nm
	D	570.5-573.5nm
	E	573.5-576.5 nm
	F	576.5-579.5 nm

Note: It maintains a tolerance of  $\pm 0.5\text{nm}$  on Wavelength Bin

### ■ Forward Voltage (Vf) Bin:

Color	Bin Code	Spec. Range
US	E18	1.6-2.4 V
UG	E18	1.6-2.4 V

Note: It maintains a tolerance of  $\pm 0.05\text{V}$  on forward voltage measurements

Official Product	HT Part No. B2972USUG20D000114E0118		
Tentative Product	*****	*****	*****
Specifications are subject to changes for improvement without advance notice. Proprietary data, drawings, company confidential all rights reserved.		05/20/2024	Version 1.6 Page 6/14

## Product Features

### Electro-Optical Characteristics

(T<sub>Soldering</sub>, 25 °C)

Series	Emitting Color	Material	V <sub>F</sub> (V)		Wavelength λ(nm)			I <sub>V</sub> (mcd)	Viewing Angle 2θ <sub>1/2</sub>
			typ	max	λ <sub>D</sub>	λ <sub>P</sub>	Δλ	Typical	
B2972USUG20	US	AlGaInP	2.0	2.4	624	632	20	71.5	X=105 Y=140
	UG	AlGaInP	2.1	2.4	571	573	15	71.5	X=105 Y=160

### Package Outline Dimension and Recommended Soldering Pattern for Reflow Soldering

(Unit:mm Tolerance: +/-0.1)

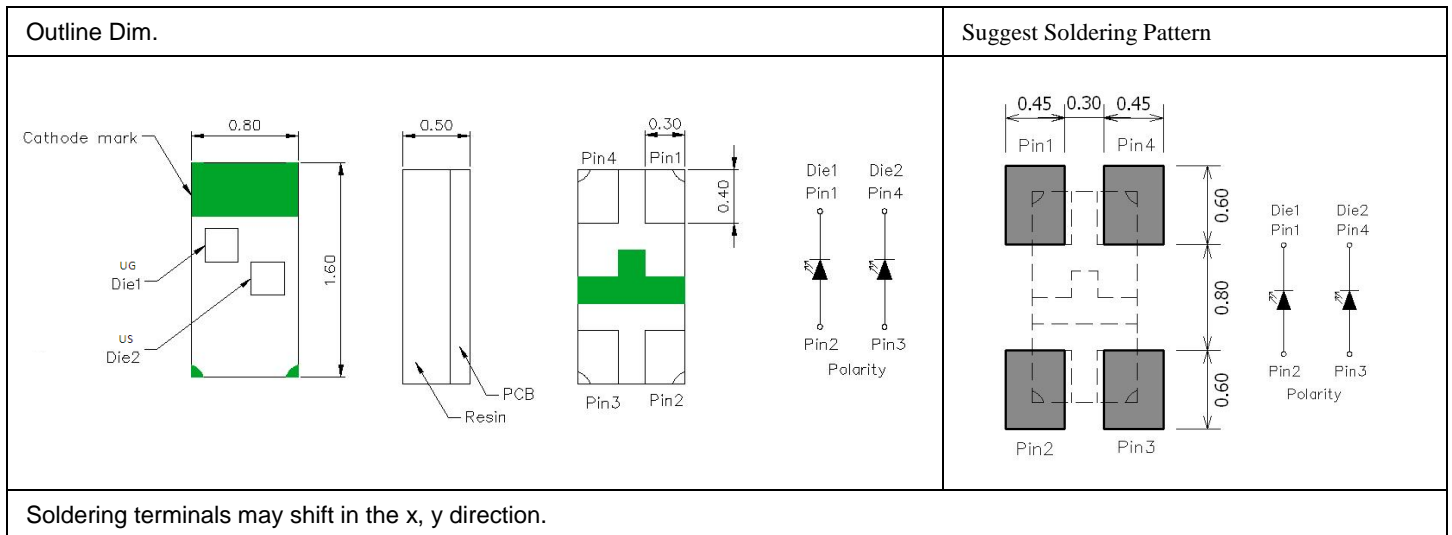

### Absolute Maximum Ratings

(T<sub>Soldering</sub> 25 °C)

Series	P <sub>D</sub> (mW)	I <sub>F</sub> (mA)	I <sub>FP</sub> (mA)*	T <sub>OP</sub> (°C)	T <sub>ST</sub> (°C)
Color	Power Dissipation	Forward Current	Pulse Forward Current	Operating Temperature	Storage Temperature
US	48	20	100	-40~+85	-40~+100
UG	48	20	100	-40~+85	-40~+100

\*Condition for I<sub>FP</sub> is pulse of 1/10 duty and 0.1msec width

Official Product	HT Part No. B2972USUG20D000114E0118		
Tentative Product	*****	*****	*****
Specifications are subject to changes for improvement without advance notice. Proprietary data, drawings, company confidential all rights reserved.		05/20/2024	Version 1.6 Page 7/14

## Characteristics of B2972USUG

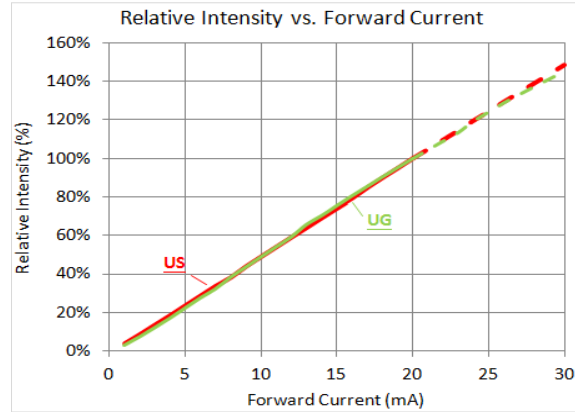
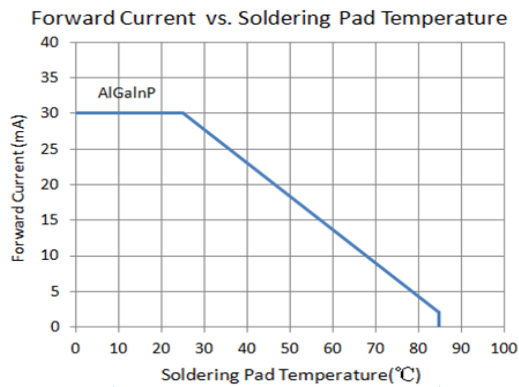
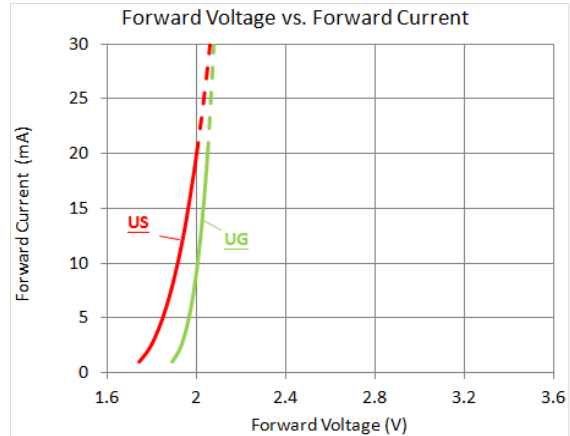
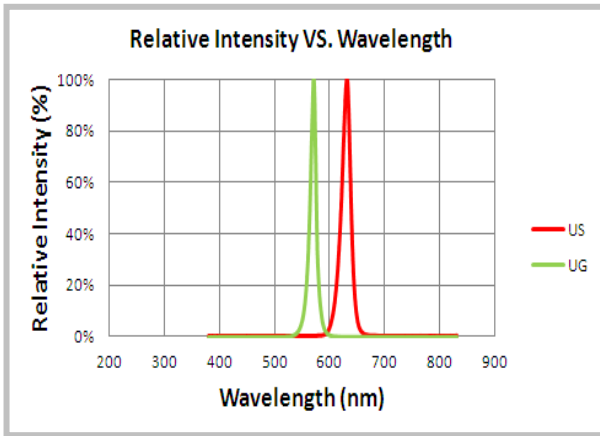

### Directive Characteristics

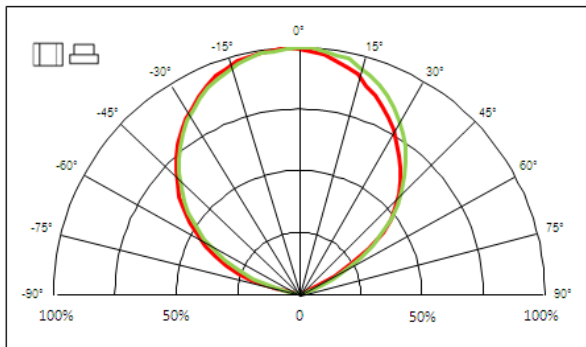

### Directive Characteristics

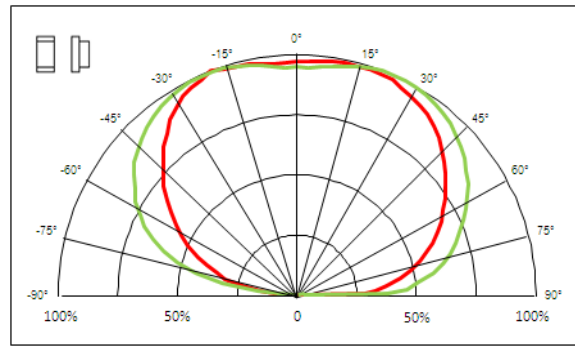

Official Product	HT Part No. B2972USUG20D000114E0118		
Tentative Product	*****	*****	*****
Specifications are subject to changes for improvement without advance notice. Proprietary data, drawings, company confidential all rights reserved.	05/20/2024	Version 1.6	Page 8/14



### Precaution for Use

1. The chips should not be used directly in any type of fluid such as water, oil, organic solvent, etc.
2. When the LEDs are illuminating, the maximum ambient temperature should be first considered before operation.
3. LEDs must be stored in a clean environment. A sealed container with a nitrogen atmosphere is necessary if the storage period is over 3 months after shipping.
4. The LEDs must be used within 4 weeks after unpacked. Unused products must be repacked in an anti-electrostatic package, folded to close any opening and then stored in a dry and cool space.
5. The appearance and specifications of the products may be modified for improvement without further notice.
6. The LEDs are sensitive to the static electricity and surge. It is strongly recommended to use a grounded wrist band and anti-electrostatic glove when handling the LEDs. If a voltage over the absolute maximum rating is applied to LEDs, it will damage LEDs. Damaged LEDs will show some abnormal characteristics such as remarkable increase of leak current, lower turn-on voltage and getting unlit at low current.

Official Product	HT Part No. B2972USUG20D000114E0118		
Tentative Product	*****	*****	*****
Specifications are subject to changes for improvement without advance notice. Proprietary data, drawings, company confidential all rights reserved.		05/20/2024	Version 1.6 Page 9/14

## Packaging Tape Dimension

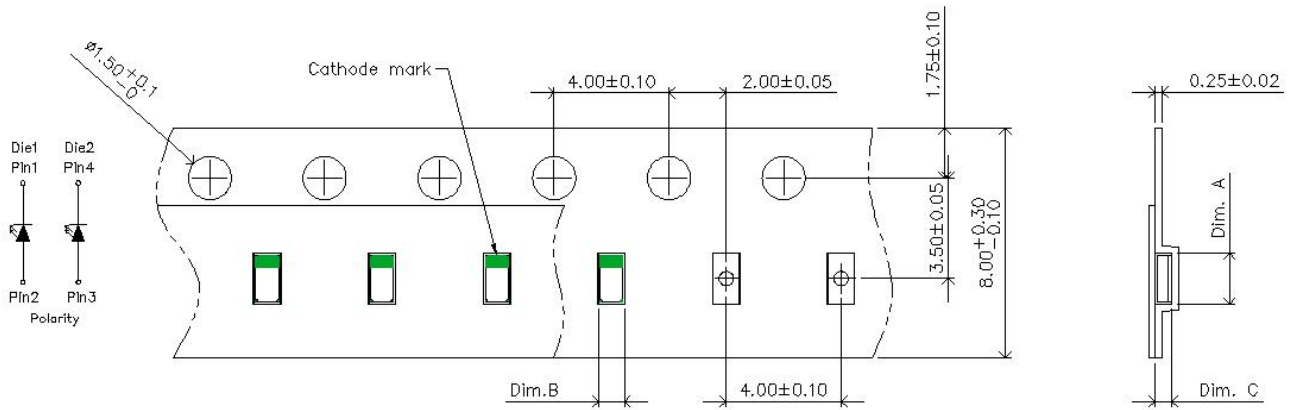

Dim. A	Dim. B	Dim. C	Q'ty/Reel
$1.75 \pm 0.05$	$0.90 \pm 0.05$	$0.65 \pm 0.05$	4K

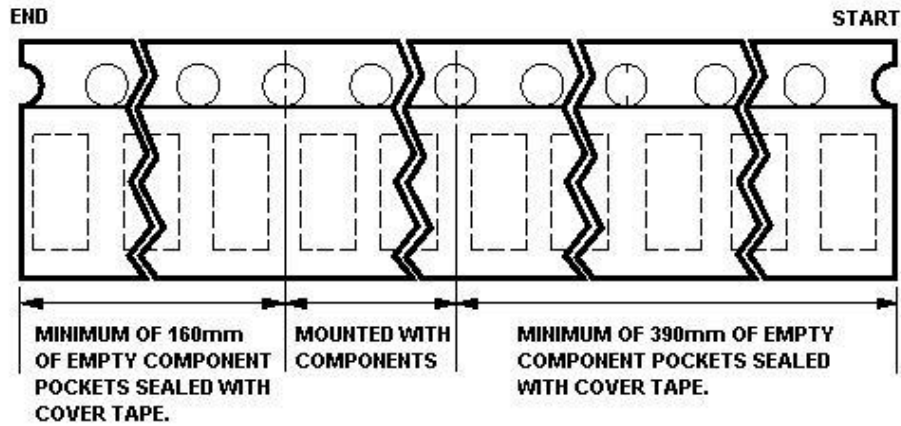

Official Product	HT Part No. B2972USUG20D000114E0118		
Tentative Product	*****	*****	*****
Specifications are subject to changes for improvement without advance notice. Proprietary data, drawings, company confidential all rights reserved.	05/20/2024	Version 1.6	Page 10/14

## Reel Dimension

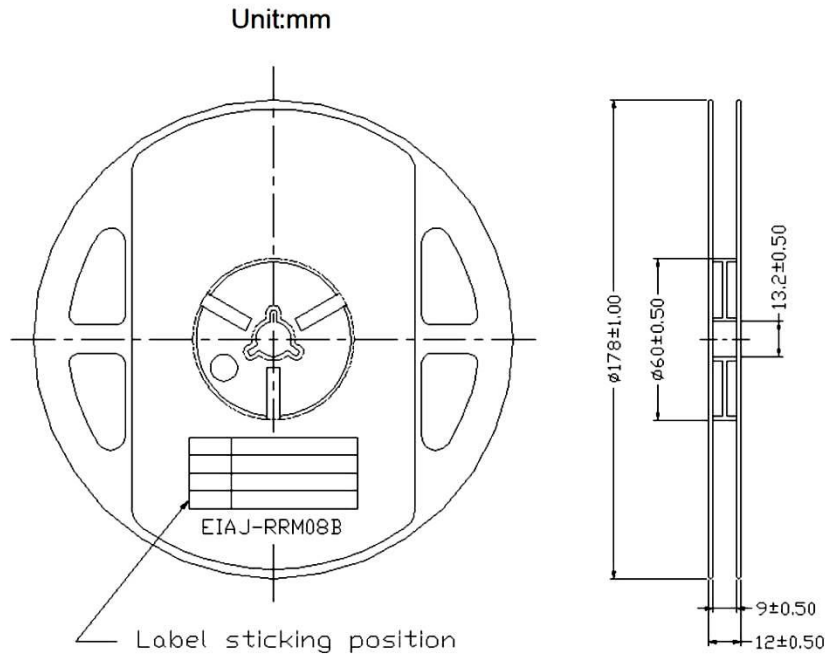

## Packing

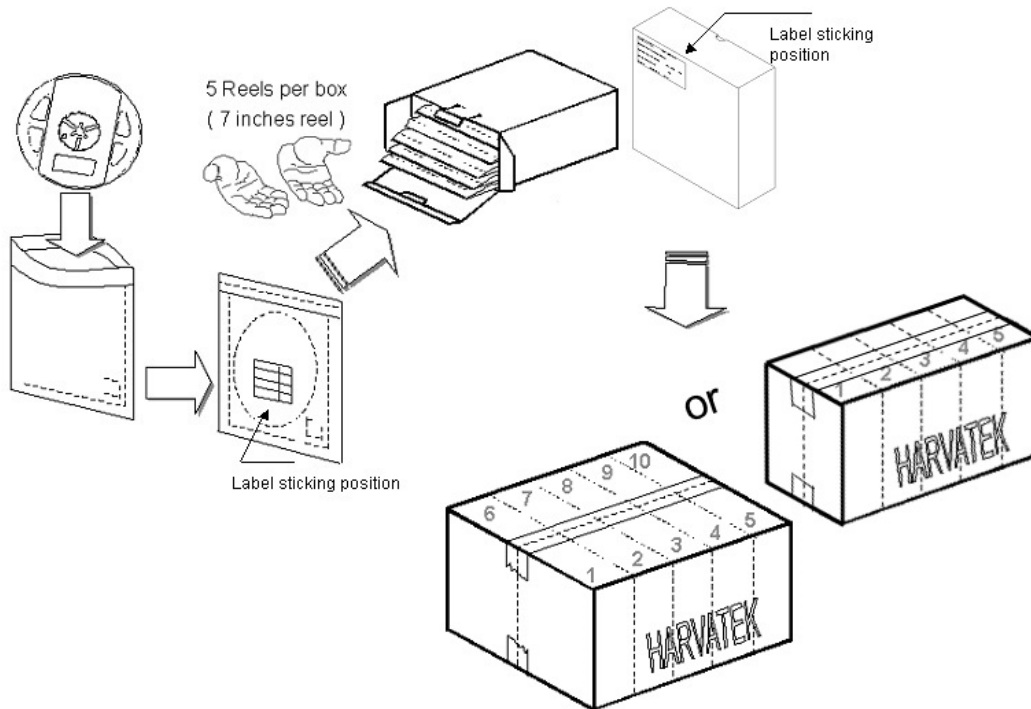

5 or 10 boxes per carton is available depending on shipment quantity.

Official Product	HT Part No. B2972USUG20D000114E0118		
Tentative Product	*****	*****	*****
Specifications are subject to changes for improvement without advance notice. Proprietary data, drawings, company confidential all rights reserved.		05/20/2024	Version 1.6 Page 11/14

**Dry Pack**

All SMD optical devices are **MOISTURE SENSITIVE**. Avoid exposure to moisture at all times during transportation or storage. Every reel is packaged in a moisture protected anti-static bag. Each bag is properly sealed prior to shipment.

A humidity indicator will be included in the moisture protected anti-static bag prior to shipment.

The packaging sequence is as follows:

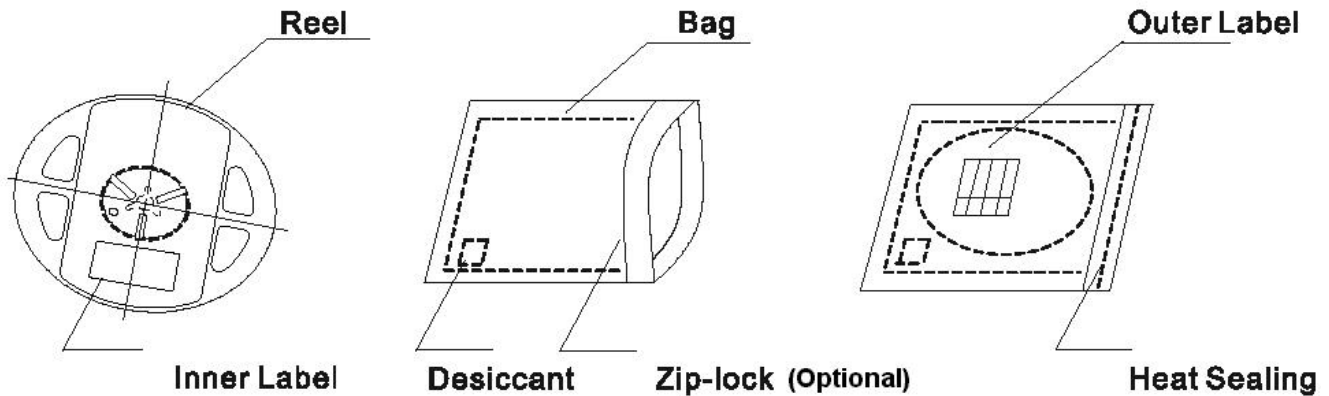

**Baking**

Baking before soldering is recommended when the package has been unsealed for 4 weeks.

The conditions are as followings:

1.  $60\pm 3^{\circ}\text{C} \times (12\sim 24\text{hrs})$  and  $<5\%RH$ , taped reel type.
2.  $100\pm 3^{\circ}\text{C} \times (45\text{min}\sim 1\text{hr})$ , bulk type.
3.  $130\pm 3^{\circ}\text{C} \times (15\text{min}\sim 30\text{min})$ , bulk type.

**Precautions**

1. Avoid exposure to moisture at all times during transportation or storage.
2. Anti-Static precaution must be taken when handling GaN, InGaN, and AlGaInP products.
3. It is suggested to connect the unit with a current limiting resistor of the proper size. Avoid applying a reverse voltage beyond the specified limit.
4. Avoid operation beyond the limits as specified by the absolute maximum ratings.
5. Avoid direct contact with the surface through which the LED emits light.
6. If possible, assemble the unit in a clean room or dust-free environment.

Official Product	HT Part No. B2972USUG20D000114E0118		
Tentative Product	*****	*****	*****
Specifications are subject to changes for improvement without advance notice. Proprietary data, drawings, company confidential all rights reserved.		05/20/2024	Version 1.6 Page 12/14

**Reflow Soldering**

Recommend soldering paste specifications:

1. Operating temp.: Above 217°C ,60~150 sec.
2. Peak temp.:260°C Max.,10sec Max.
3. Reflow soldering should not be done more than two times.
4. Never attempt next process until the component is cooled down to room temperature after reflow.
5. The recommended reflow soldering profile (measured on the surface of the LED terminal) is as following:

Lead-free Solder Profile

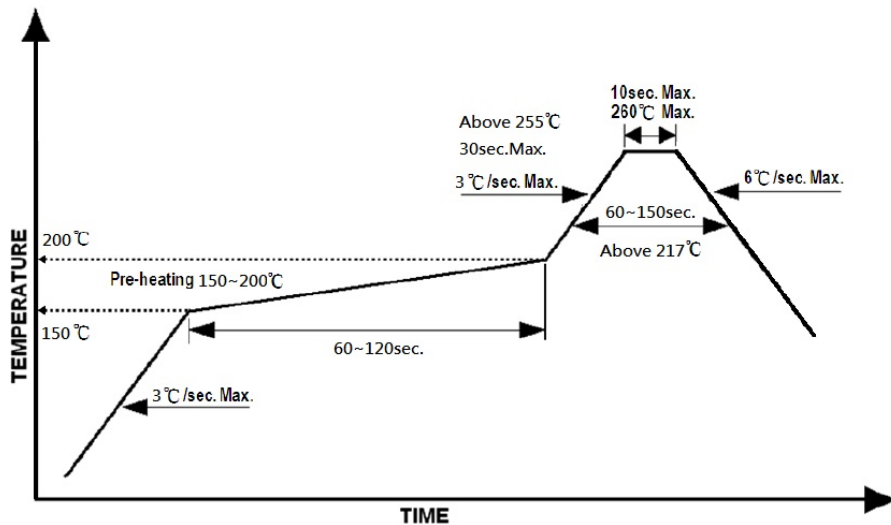

**Reworking**

- Rework should be completed within 5 seconds under 260 °C .
- The iron tip must not come in contact with the copper foil.
- Twin-head type is preferred.

**Cleaning**

Following are cleaning procedures after soldering:

- An alcohol-based solvent such as isopropyl alcohol (IPA) is recommended.
- Temperature x Time should be 50°C x 30sec. or <30°C x 3min
- Ultrasonic cleaning: < 15W/ bath; bath volume ≤ 1liter
- Curing: 100 °C max, <3min

Official Product	HT Part No. B2972USUG20D000114E0118		
Tentative Product	*****	*****	*****
Specifications are subject to changes for improvement without advance notice. Proprietary data, drawings, company confidential all rights reserved.	05/20/2024	Version 1.6	Page 13/14

### Cautions of Pick and Place

- Avoid stress on the resin at elevated temperature.
- Avoid rubbing or scraping the resin by any object.
- Electric-static may cause damage to the component. Please ensure that the equipment is properly grounded. Use of an ionizer fan is recommended.

### Revise History

Rev.	Descriptions	Date	Page
1.0	-	07/12/2013	-
1.1	New Form	05/22/2014	-
1.2	Renew form	03/18/2016	-
1.3	Renew form	12/21/2016	-
1.4	Renew Soldering Pattern	05/28/2018	P7
1.5	Renew form	05/08/2020	-
1.6	Add Customer Product Code	05/20/2024	-

Official Product	HT Part No. B2972USUG20D000114E0118		
Tentative Product	*****	*****	
Specifications are subject to changes for improvement without advance notice. Proprietary data, drawings, company confidential all rights reserved.		05/20/2024	Version 1.6 Page 14/14