

## ULTRA LOW CAPACITANCE STEERING DIODE/TVS ARRAY

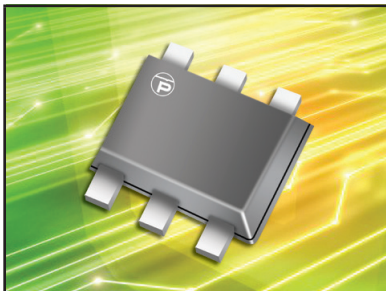

**SC-89 PACKAGE**

### DESCRIPTION

The PLR0502-6 is an ultra low capacitance (0.9pF typical) steering diode and TVS array combo. This device provides circuit protection for interfaces and wireless bus applications and portable electronics. The PLR0502 is ideally suited to protect USB(1.0-3.1), Gigabit Ethernet, HDMI (2.0 & 4K) data I/O ports against the effects of ESD and EFT.

The PLR0502-6 meets the requirements of IEC 61000-4-2 (ESD) and IEC 61000-4-4 (EFT). At higher operating frequencies or faster edge rates, insertion loss and signal integrity are a major concern. The PLR0502 offers an ultra low capacitance and low leakage current in a SC-89 package.

### FEATURES

- IEC 61000-4-2 (ESD) Compliant: Air  $\pm 15$ kV, Contact  $\pm 8$ kV
- IEC 61000-4-4 (EFT) Complaint
- IEC 61000-4-5 (Surge): 3A, 50W, 8/20 $\mu$ s
- Low Clamping Voltage
- Low Leakage Current
- Unidirectional Configuration
- Protects 2 I/O Ports and Power Supply
- Ultra Low Capacitance: 0.3pF (Typical I/O - I/O)
- RoHS Compliant
- REACH Compliant

### APPLICATIONS

- USB (1.0 to 3.1)
- HDMI (2.0 & 4K)
- Gigabit Ethernet
- DVI
- IEEE 1394 FireWire

### MECHANICAL CHARACTERISTICS

- Molded JEDEC SC-89 Package
- Approximate Weight: 3.05mg
- Lead-Free Pure-Tin Plating (Annealed)
- Solder Reflow Temperature:  
Pure-Tin - Sn, 100: 260-270°C
- 8mm Tape and Reel Per EIA Standard 481
- Flammability Rating UL 94V-0

### PIN CONFIGURATION

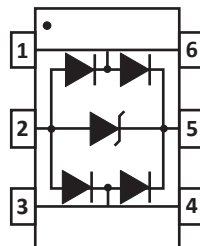

**TYPICAL DEVICE CHARACTERISTICS**
**MAXIMUM RATINGS @ 25°C Unless Otherwise Specified**

PARAMETER	SYMBOL	VALUE	UNITS
Operating Temperature	$T_J$	-55 to 125	°C
Storage Temperature	$T_{STG}$	-55 to 150	°C
Peak Pulse Power ( $t_p = 8/20\mu s$ ) - See Figure 1	$P_{PP}$	50	Watts
ESD per IEC 61000-4-2 (Air)	$V_{ESD}$	±25	kV
ESD per IEC 61000-4-2 (Contact)	$V_{ESD}$	±15	kV

**ELECTRICAL CHARACTERISTICS PER LINE @ 25°C Unless Otherwise Specified**

PART NUMBER	DEVICE MARKING	RATED STAND-OFF VOLTAGE $V_{WM}$ VOLTS	MINIMUM BREAKDOWN VOLTAGE @1mA $V_{(BR)}$ VOLTS	MAXIMUM CLAMPING VOLTAGE (Fig. 2) @ $I_p = 1A$ $V_c$ VOLTS	MAXIMUM CLAMPING VOLTAGE (Fig. 2) @ $I_p = 3A$ $V_c$ VOLTS	MAXIMUM LEAKAGE CURRENT @ $V_{WM}$ $I_D$ $\mu A$	MAXIMUM CAPACITANCE I/O - I/O (Note 1) @0V, 1MHz $C_j$ pF
PLR0502-6	P26	5.0	6.0	11.0	17.0	1	0.7

**NOTE**

1. Maximum capacitance between I/O to GND is 0.9pF.

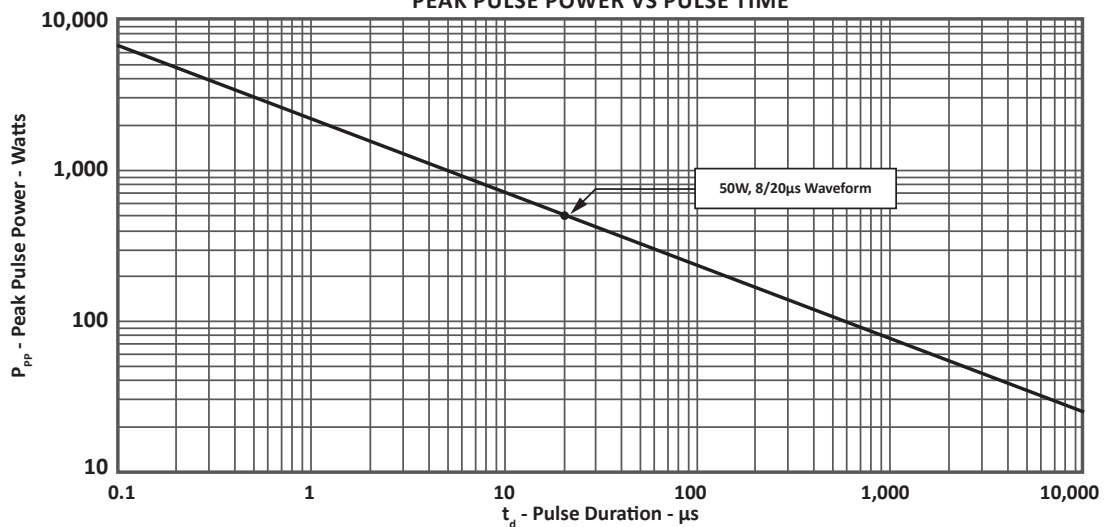
**FIGURE 1  
PEAK PULSE POWER VS PULSE TIME**

## TYPICAL DEVICE CHARACTERISTICS

FIGURE 2  
PULSE WAVE FORM

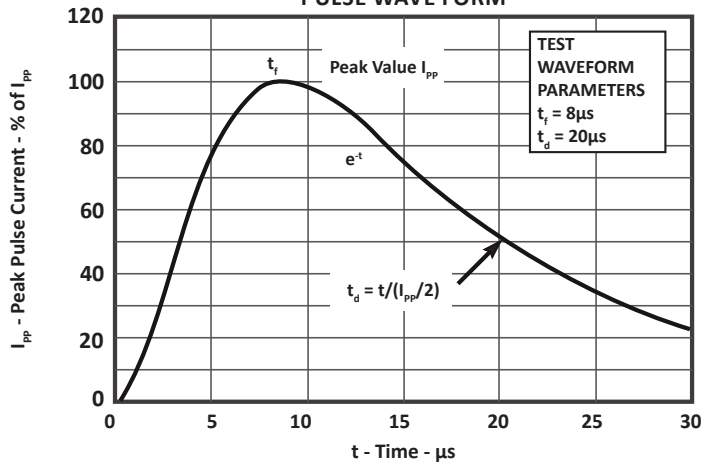
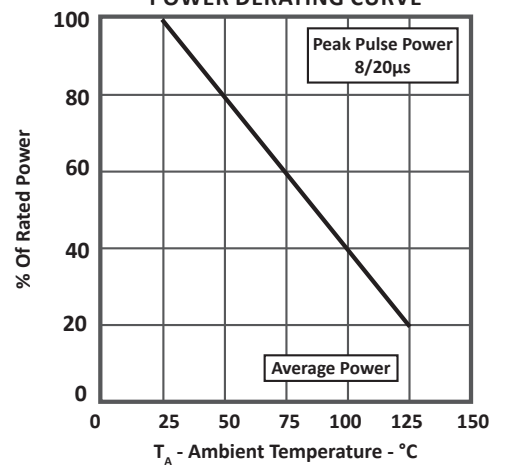

FIGURE 3  
POWER DERATING CURVE



## SC-89 PACKAGE INFORMATION

### OUTLINE DIMENSIONS

DIM	MILLIMETERS		INCHES	
	MIN	MAX	MIN	MAX
A	0.50	0.60	0.019	0.024
B	0.15	0.30	0.005	0.012
c	0.10	0.18	0.003	0.007
D	1.50	1.70	0.059	0.067
E	1.55	1.70	0.061	0.067
E1	1.10	1.25	0.043	0.049
e	0.50 BSC		0.020 BSC	
L	0.10	0.30	0.003	0.012
L1	0.10	0.20	0.003	0.008

#### NOTES

1. Controlling dimension: millimeters.
2. Dimensioning and tolerances per ANSI Y14.5M, 1985.
3. Dimensions are exclusive of mold flash and metal burrs.

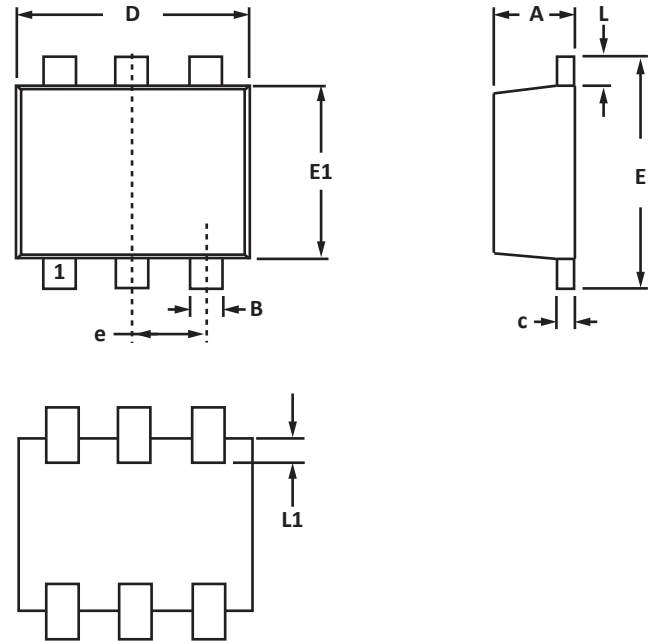

### PAD LAYOUT DIMENSIONS

DIM	MILLIMETERS	INCHES
	NOMINAL	NOMINAL
C	1.45	0.057
P	0.50	0.020
G	0.60	0.024
X	0.30	0.012
Y	0.85	0.033
Z	2.30	0.090

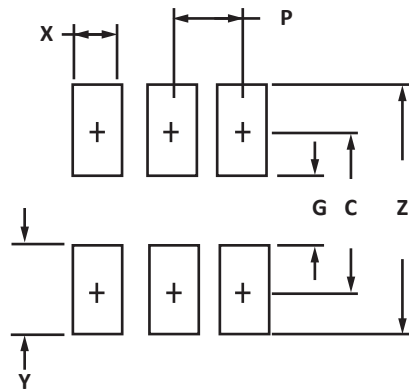

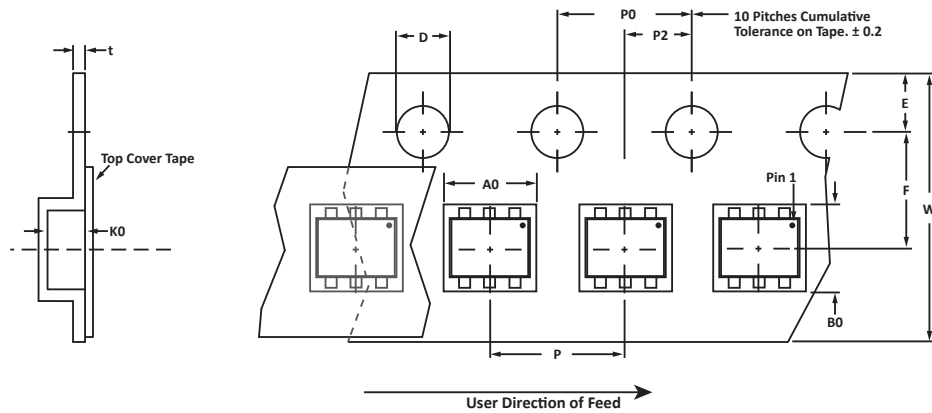
**TAPE AND REEL**

**SPECIFICATIONS**

REEL DIA.	TAPE WIDTH	A0	B0	K0	D	E	F	W	P0	P2	P	tmax
178mm (7")	8mm	1.77 ± 0.05	1.78 ± 0.05	0.67 ± 0.05	1.50 ± 0.10	1.75 ± 0.10	3.50 ± 0.05	8.00 ± 0.30	4.00 ± 0.10	2.00 ± 0.05	4.00 ± 0.10	0.25

**NOTES**

1. Dimensions are in millimeters.
2. Surface mount product is taped and reeled in accordance with EIA-481.
3. Suffix - T7 = 7" Reel - 3,000 pieces per 8mm tape.
4. Marking on Part - marking code (see page 2) and pin one defined by dot on package.

**ORDERING INFORMATION**

BASE PART NUMBER	LEADFREE SUFFIX	TAPE SUFFIX	QTY/REEL	REEL SIZE	TUBE QTY
PLR0502-6	N/A	-T7	3,000	7"	N/A

This device is only available in a Lead-Free configuration.

## COMPANY INFORMATION

---

### COMPANY PROFILE

In business more than 20 years, ProTek Devices™ is a privately held semiconductor company. The company offers a product line of overvoltage protection and overcurrent protection components. These include transient voltage suppressor array (TVS arrays) avalanche breakdown diode, steering diode TVS array and electronics SMD chip fuses. These components deliver circuit protection in electronic systems from numerous overvoltage and overcurrent events. They include lightning; electrostatic discharge (ESD); nuclear electromagnetic pulses (NEMP); inductive switching; and electromagnetic interference (EMI) / radio frequency interference (RFI). ProTek Devices also offers LED wafer die for ESD protection and related high frequency products.

### CONTACT US

#### Corporate Headquarters

2929 South Fair Lane  
Tempe, Arizona 85282  
USA

#### By Telephone

General: 602-431-8101  
Sales: & Marketing: 602-414-5109  
Customer Service: 602-414-5114  
Product Technical Support: 602-414-5107

#### By Fax

General: 602-431-2288

#### By E-mail:

Asia Sales: [asiasales@protekdevices.com](mailto:asiasales@protekdevices.com)  
Europe Sales: [europesales@protekdevices.com](mailto:europesales@protekdevices.com)  
U.S. Sales: [ussales@protekdevices.com](mailto:ussales@protekdevices.com)  
Distributor Sales: [distysales@protekdevices.com](mailto:distysales@protekdevices.com)  
Customer Service: [service@protekdevices.com](mailto:service@protekdevices.com)  
Technical Support: [support@protekdevices.com](mailto:support@protekdevices.com)

#### ProTek Devices (Asia Pacific) Pte. Ltd.

8 Ubi Road 2, #06-19  
Zervex  
Singapore - 408538  
Tel: +65-67488312  
Fax: +65-67488313

#### Web

[www.protekdevices.com](http://www.protekdevices.com)

COPYRIGHT © ProTek Devices 2016 - This literature is subject to all applicable copyright laws and is not for resale in any manner.

SPECIFICATIONS: ProTek reserves the right to change the electrical and or mechanical characteristics described herein without notice.

DESIGN CHANGES: ProTek reserves the right to discontinue product lines without notice and that the final judgement concerning selection and specifications is the buyer's and that in furnishing engineering and technical assistance. ProTek assumes no responsibility with respect to the selection or specifications of such products. ProTek makes no warranty, representation or guarantee regarding the suitability of its products for any particular purpose, nor does ProTek assume any liability arising out of the application or use of any product or circuit and specifically disclaims any and all liability without limitation special, consequential or incidental damages.

LIFE SUPPORT POLICY: ProTek Devices products are not authorized for use in life support systems without written consent from the factory.