

600 WATT TVS COMPONENT



APPLICATIONS

- Automotive

FEATURES

- **AEC-Q101 Qualified**
- UL File Recognition #E208219
- Compatible with IEC 61000-4-2 (ESD): Level 4: Air $\pm 15\text{kV}$, Contact $\pm 8\text{kV}$
- Compatible with IEC 61000-4-4 (EFT): 40A, 5/50ns
- Compatible with IEC 61000-4-5 (Surge): 8/20 μs Waveform
- Glass Passivated Chip
- 600 Watts Peak Pulse Power per Line ($t_p = 10/1000\mu\text{s}$)
- Low Leakage Current
- Bidirectional Configuration
- Excellent Clamping Capability
- Very Fast Response Time
- Available in Multiple Voltages
- RoHS Compliant
- REACH Compliant

MECHANICAL CHARACTERISTICS

- Molded JEDEC DO-214AA Package
- Approximate Weight: 0.103 grams
- Lead-Free Pure-Tin Plating (Annealed)
- Solder Reflow Temperature:
Pure-Tin - Sn, 100: 260-270°C
- 12mm Tape and Reel Per EIA Standard 481
- Terminal: Solderable per MIL-STD-750, Method 2026
- Flammability Rating UL 94V-0

PIN CONFIGURATION

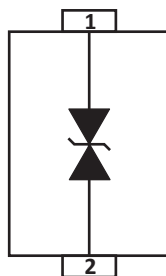

TYPICAL DEVICE CHARACTERISTICS

MAXIMUM RATINGS @ 25°C Unless Otherwise Specified

PARAMETER	SYMBOL	VALUE	UNITS
Operating Temperature	T_J	-55 to 150	°C
Storage Temperature	T_{STG}	-55 to 150	°C
Peak Pulse Power (tp =10/1000µs) - See Figure 1 and Note 1	P_{PP}	600	Watts
Power Dissipation on Infinite Heatsink at $T_L = 75^\circ\text{C}$	P_D	5.0	Watts

NOTE

1. Non-repetitive current pulse per Figure 2 and derated above $T_A = 25^\circ\text{C}$ per Figure 3.

ELECTRICAL CHARACTERISTICS PER LINE @ 25°C Unless Otherwise Specified

PART NUMBER (Note 1)	DEVICE MARKING	REVERSE STAND-OFF VOLTAGE V_{RWM} VOLTS	BREAKDOWN VOLTAGE $V_{(BR)} @ I_T$ VOLTS		TEST CURRENT @ I_T mA	MAXIMUM CLAMPING VOLTAGE (Fig. 2) @ I_P V_C VOLTS	MAXIMUM REVERSE SURGE CURRENT @ I_{PP} AMPS	MAXIMUM REVERSE LEAKAGE CURRENT @ V_{RWM} I_R µA
			MIN	MAX				
			PAM29DOAA26CA	CE				
PAM29DOAA28CA	CG	28.0	31.10	34.40	1	45.4	13.2	1
PAM29DOAA33CA	CM	33.0	36.70	40.60	1	53.3	11.3	1

NOTE

1. 5% tolerance.

FIGURE 1
PEAK PULSE POWER VS PULSE TIME

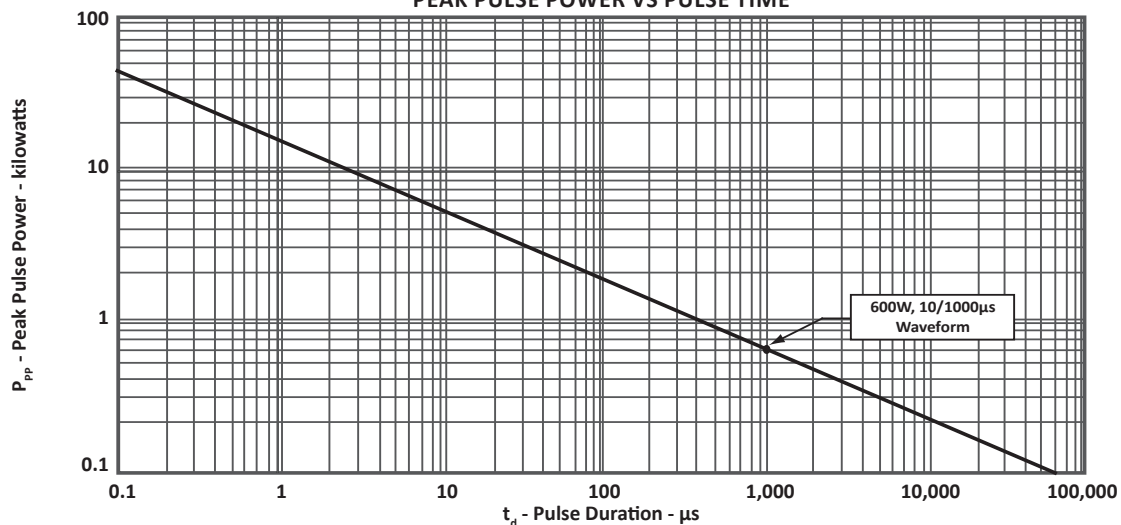

TYPICAL DEVICE CHARACTERISTICS

**FIGURE 2
PULSE WAVEFORM**

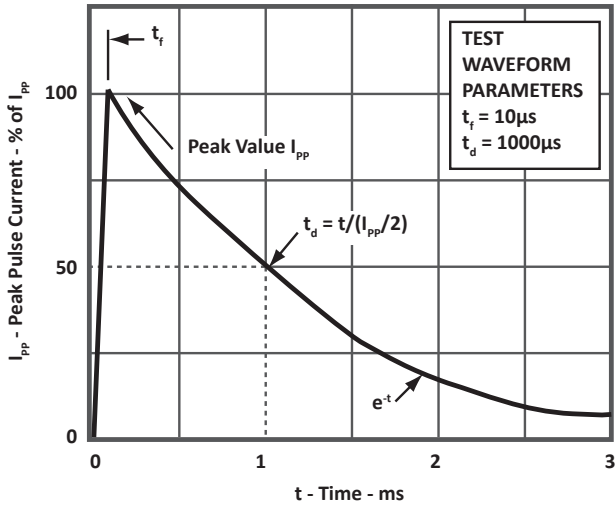

**FIGURE 3
POWER DERATING CURVE**

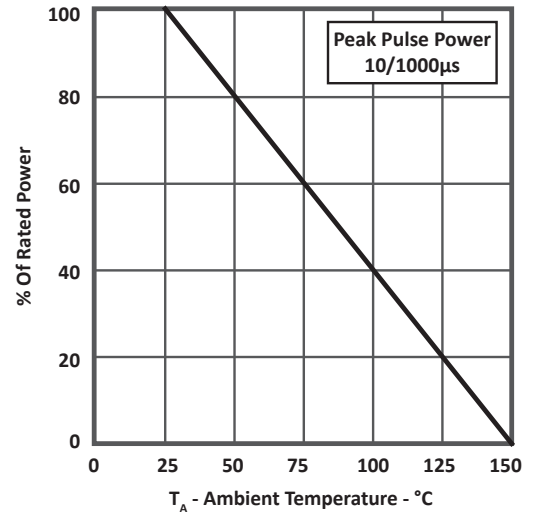

**FIGURE 4
TYPICAL JUNCTION CAPACITANCE**

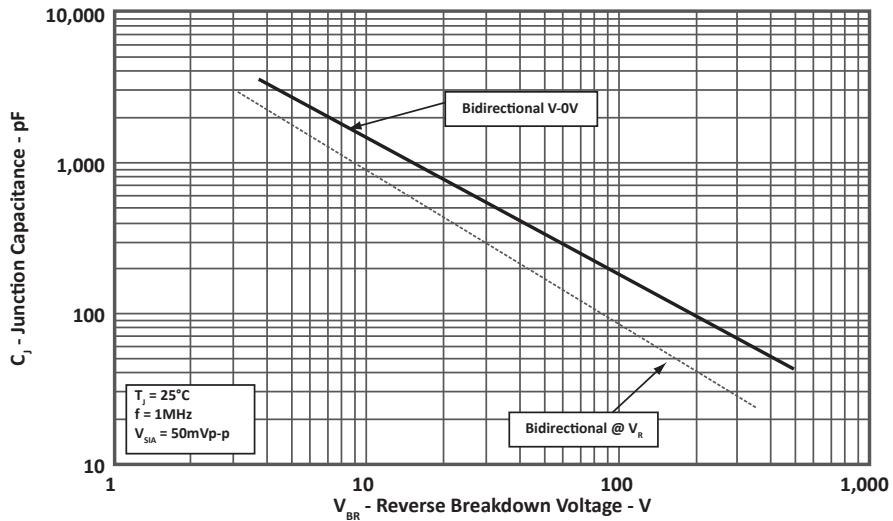

DO-214AA PACKAGE INFORMATION

OUTLINE DIMENSIONS

DIM	MILLIMETERS		INCHES	
	MIN	MAX	MIN	MAX
A	1.96	2.20	0.077	0.087
B	4.35	4.85	0.171	0.191
C	3.30	3.94	0.130	0.155
D	2.13	2.44	0.084	0.096
E	0.75	1.52	0.030	0.060
F	0.02	0.20	0.001	0.008
G	5.10	5.50	0.201	0.216
H	0.15	0.30	0.006	0.012

NOTES

1. Dimensions are exclusive of mold flash and metal burrs.

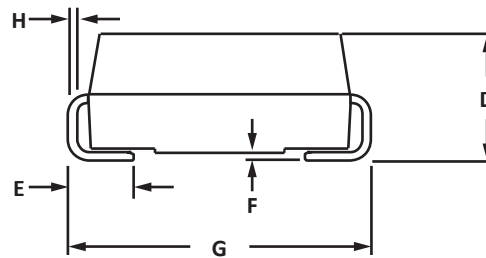
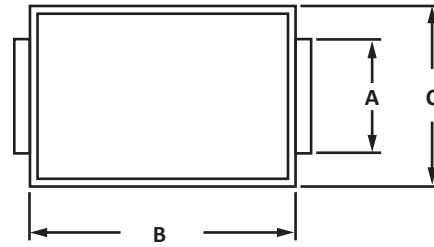

PAD LAYOUT DIMENSIONS

DIM	MILLIMETERS		INCHES	
	MIN	MAX	MIN	MAX
A	2.03	-	0.080	-
B	1.91	-	0.075	-
C	-	2.54	-	1.00
D	1.91	-	0.075	-

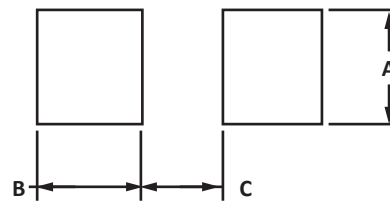

TAPE AND REEL

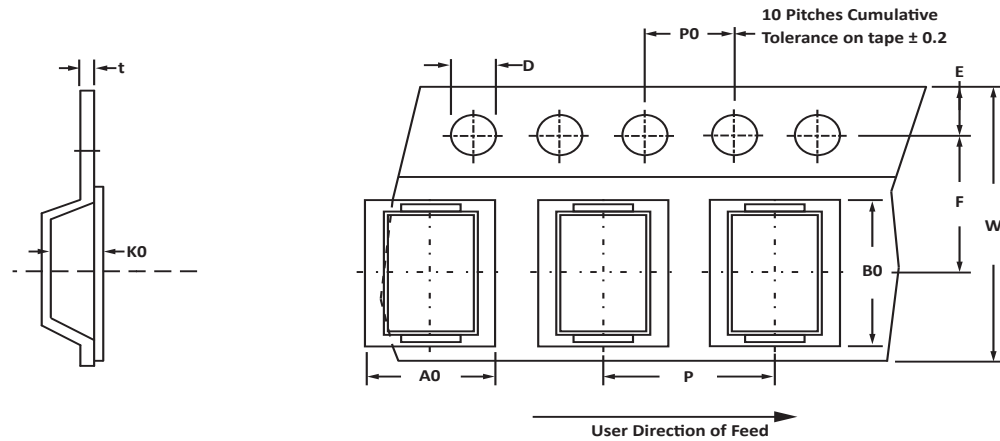

SPECIFICATIONS

REEL DIA.	TAPE WIDTH	A0	B0	K0	D	E	F	W	P0	P	tmax
330mm (13")	12mm	3.67 ± 0.10	5.69 ± 0.10	2.67 ± 0.10	1.55 ± 0.10	1.75 ± 0.10	5.5 ± 0.05	12.00 ± 0.30	4.00 ± 0.10	8.00 ± 0.10	0.4

NOTES

- Dimensions are in millimeters.
- Surface mount product is taped and reeled in accordance with EIA-481.
- Suffix - T13 = 13" Reel - 3,000 pieces and T500 = 7" Reel - 500 pieces per 16mm tape.
- Marking on Part - marking code (see page 2), date code and logo.

ORDERING INFORMATION

BASE PART NUMBER (Voltage = xx)	LEADFREE SUFFIX	TAPE SUFFIX	QTY/REEL	REEL SIZE	TUBE QTY
PAM29DOAAxxCA	N/A	-T500	500	7"	N/A
PAM29DOAAxxCA	N/A	-T13	3,000	13"	N/A

This device is only available in a Lead-Free configuration.

COMPANY INFORMATION

COMPANY PROFILE

In business more than 20 years, ProTek Devices™ is a privately held semiconductor company. The company offers a product line of overvoltage protection and overcurrent protection components. These include transient voltage suppressor array (TVS arrays) avalanche breakdown diode, steering diode TVS array and electronics SMD chip fuses. These components deliver circuit protection in electronic systems from numerous overvoltage and overcurrent events. They include lightning; electrostatic discharge (ESD); nuclear electromagnetic pulses (NEMP); inductive switching; and electromagnetic interference (EMI) / radio frequency interference (RFI). ProTek Devices also offers LED wafer die for ESD protection and related high frequency products.

CONTACT US

Corporate Headquarters

2929 South Fair Lane
Tempe, Arizona 85282
USA

By Telephone

General: 602-431-8101
Sales: & Marketing: 602-414-5109
Customer Service: 602-414-5114
Product Technical Support: 602-414-5107

By Fax

General: 602-431-2288

By E-mail:

Asia Sales: asiasales@protekdevices.com
Europe Sales: europesales@protekdevices.com
U.S. Sales: ussales@protekdevices.com
Distributor Sales: distysales@protekdevices.com
Customer Service: service@protekdevices.com
Technical Support: support@protekdevices.com

ProTek Devices (Asia Pacific) Pte. Ltd.

8 Ubi Road 2, #06-19
Zervex
Singapore - 408538
Tel: +65-67488312
Fax: +65-67488313

Web

www.protekdevices.com

COPYRIGHT © ProTek Devices 2017 - This literature is subject to all applicable copyright laws and is not for resale in any manner.

SPECIFICATIONS: ProTek reserves the right to change the electrical and or mechanical characteristics described herein without notice.

DESIGN CHANGES: ProTek reserves the right to discontinue product lines without notice and that the final judgement concerning selection and specifications is the buyer's and that in furnishing engineering and technical assistance. ProTek assumes no responsibility with respect to the selection or specifications of such products. ProTek makes no warranty, representation or guarantee regarding the suitability of its products for any particular purpose, nor does ProTek assume any liability arising out of the application or use of any product or circuit and specifically disclaims any and all liability without limitation special, consequential or incidental damages.

LIFE SUPPORT POLICY: ProTek Devices products are not authorized for use in life support systems without written consent from the factory.