





Product Specification			
	Model: GVTV57TPAF2R0	Rev. No.	Issued Date.
		A	2013,12,17
			Page. 1 / 25

**Thin-Film-Transistor LCD Module  
Model: GVTV57TPAF2R0**

Acceptance

**Solomon Goldentek Display Corp.**  
 NO. 18 Ta-Yeh St., Ta-Fa Industrial Park, Ta-Liao  
 Hsiang, Kaohsiung Hsien 831, TAIWAN , R.O.C.  
 FAX: 886-7-7886800

Approved and Checked by

Approved by	Checked by		Made by
			



Product Specification			
	Model: GVTV57TPAF2R0	Rev. No.	Issued Date.
		A	2013,12,17
			Page.
			3 / 25

## Contents

1	General Description and Features .....	4
1.1	Features .....	4
1.2	LCD Module.....	4
2	Mechanical Information.....	5
3	Electrical Specifications.....	6
3.1	Absolute Max. Ratings.....	6
3.2	Electrical Characteristics .....	8
3.3	AC Timing Characteristic of The LCD .....	9
3.4	Back-Light Unit .....	11
4	Optical Characteristics.....	12
4.1	Optical characteristic of the LCD .....	12
5	Input Terminal Pin Assignment .....	15
5.1	Pin Assignment.....	15
5.2	Back-light Unit (BLU) .....	16
5.3	Block Diagram .....	17
5.4	Basic Display Color and Gray Scale .....	18
6	Touch screen panel .....	19
6.1	Electrical Characteristics .....	19
6.2	Mechanical & Reliability Characteristics .....	19
6.3	Touch Panel Unit.....	19
7	Reliability Condition.....	20
8	Dimensional Outlines .....	21
9	Incoming Inspection Standards .....	22
9.1	Inspection and Environment Conditions.....	22

Product Specification				
	Model: GVTV57TPAF2R0	Rev. No.	Issued Date.	Page.
		A	2013,12,17	4 / 25

## 1 General Description and Features

GVTV57TPAF2R0 is a transmissive type color active matrix TFT (Thin Film Transistor) liquid crystal display (LCD) that uses amorphous silicon TFT as a switching device. This model is composed of a TFT-LCD module, a driver circuit and a back-light unit. Graphics and texts can be displayed on a VGA 640 (W) x 3 x 480 (H) dots with 262,144 colors by supplying 18 bits data signal (6bits/each color). The following table described the features of GVTV57TPAF2R0.

### 1.1 Features

- ◆ Transmissive and back-light with 30 LEDs are available
- ◆ TN (Twisted Nematic) mode.
- ◆ Digital RGB (6bits/color) data transfer
- ◆ Clock signal: latching data at the falling edge.
- ◆ RoHS Compliance

### 1.2 LCD Module

Item	Specification	Unit
Screen Size	5.7 inches	Diagonal
Display Resolution	640 (H) x 480 (V)	Pixel
Active Area	115.20 (H) x 86.40 (V)	mm
Outline Dimension	144.00 (H) x 104.60 (V) x 14.5 (T)	mm
Display Mode	Normally white mode/ Transmissive/ Wide view	--
Pixel Arrangement	R,G,B Vertical Tripe	--
Pixel size	181.5 x 181.5	um
Display Color	262K Colors	--
Viewing Direction	6 o'clock	--
Input Interface	Digital RGB (6bits/color) Data Transfer	--

Product Specification				
	Model: GVTV57TPAF2R0	Rev. No.	Issued Date.	Page.
		A	2013,12,17	5 / 25

## 2 Mechanical Information

Item	Min.	Typ.	Max.	Unit	Note	
Module Size	Horizontal (H)	--	144.00	--	mm	(1)
	Vertical (V)	--	104.60	--	mm	(1)
	Thickness (T)	--	14.5	--	mm	(1)
Weight	--	TBD	--	g	--	

Note (1) Excluding backlight cables. . Refer to the Outline Dimension Drawing as attached.

## Product Specification



Model: GVTV57TPAF2R0

Rev. No.	Issued Date.	Page.
A	2013,12,17	6 / 25

### 3 Electrical Specifications

#### 3.1 Absolute Max. Ratings

##### 3.1.1 Absolute Ratings of Environment

If the operating condition exceeds the following absolute maximum ratings, the TFT LCD module may be damaged permanently.

(Ta=25±2°C, V<sub>SS</sub>=GND=0)

Item	Symbol	Min.	Max.	Unit	Note
Storage temperature	T <sub>STG</sub>	-30	80	°C	(1)
Operating temperature	T <sub>OPR</sub>	-30	80	°C	(1,2,3)

Note (1) 90 % RH Max. ( 40 °C ≥ Ta ). Maximum wet-bulb temperature at 39 °C or less. (Ta > 40 °C) No condensation.

Note (2) In case of below 0°, the response time of liquid crystal (LC) becomes slower and the color of panel becomes darker than normal one. Level of retardation depends on temperature, because of LC's character

Note (3) Only operation is guaranteed at operating temperature. Contrast, response time, another display quality are evaluated at +25°C.

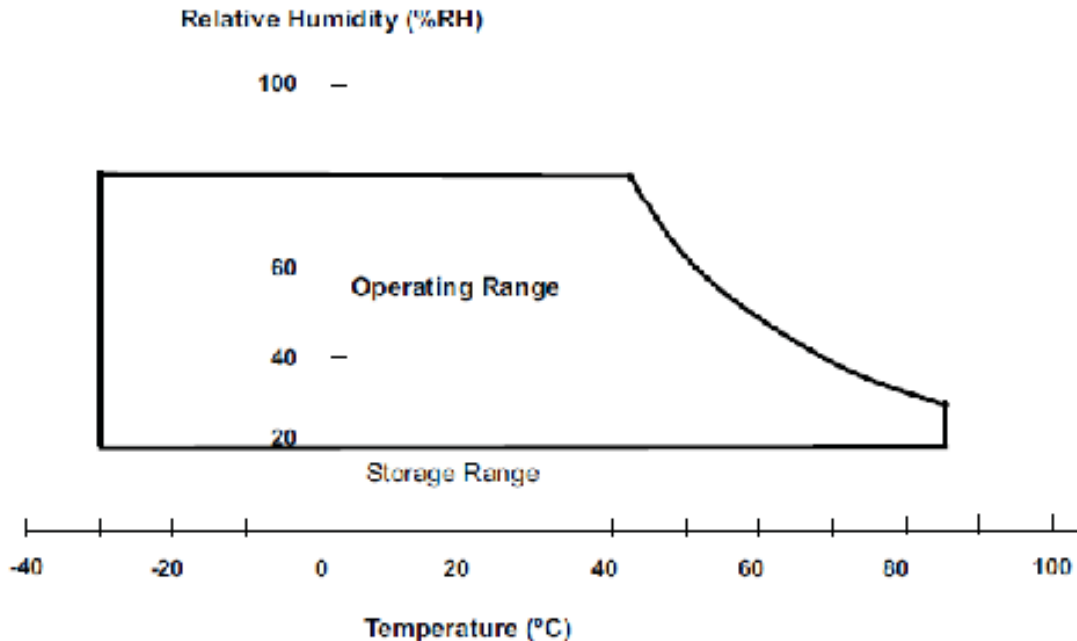

## Product Specification



Model: GVTV57TPAF2R0

Rev. No.

Issued Date.

Page.

A

2013,12,17

7 / 25

### 3.1.2 Electrical Absolute Maximum Ratings

( $V_{SS}=GND=0$ )

Parameter	Symbol	Min.	Max.	Unit	Remark
Power supply voltage	$V_{CC}$	-0.3	5.0	V	
Signal input voltage	R0-R5,G0-G5, B0-B5,DCLK,DE	-0.3	$V_{CC}+0.3$	V	--
Permissive input ripple voltage	$V_{RF}$	--	100	mVp-p	$V_{CC} = +3.3V$

Display On/Off Sequence :

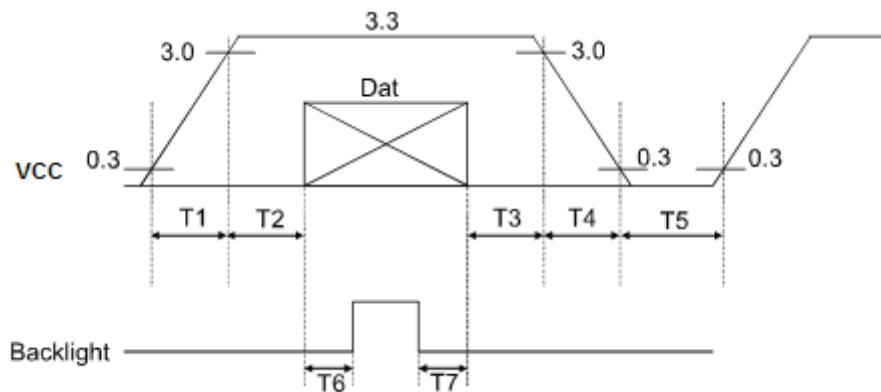

Data: DCLK, R0 ~ R5, G0 ~ G5, B0 ~ B5, DE

$T1 \leq 10ms$ ,  $50ms \leq T2$ ,  $0 < T3 \leq 50ms$ ,  $0 < T4 \leq 10ms$ ,  $1s \leq T5$ ,  $200ms \leq T6$ ,  $200ms \leq T7$

## Product Specification



Model: GVTV57TPAF2R0

Rev. No.	Issued Date.	Page.
A	2013,12,17	8 / 25

### 3.2 Electrical Characteristics

#### 3.2.1 DC Electrical Characteristics of the TFT LCD

(Ta=25±2°C, V<sub>SS</sub>=GND=0)

Item	Symbol	Min.	Typ.	Max.	Unit	Remark
Power supply	VCC	3.0	3.3	3.6	V	Note 1
Input Voltage for logic	H Level	V <sub>IH</sub>	0.7VCC	-	V	
	L Level	V <sub>IL</sub>	0	-	0.3VCC	V
Power Supply current	ICC		(120)	(160)	mA	Note 2

Note1: Vcc-dip conditions

Vcc-dip conditions should also follow the Vcc-turn-on conditions

T<sub>d</sub> ≤ 10ms

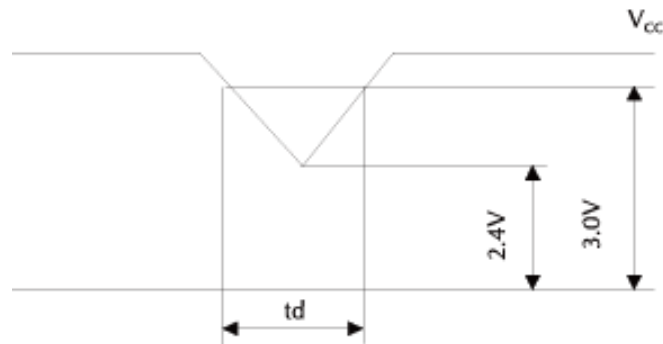

Note2: f<sub>v</sub> =60Hz , Ta=25°C , Display pattern : Black pattern

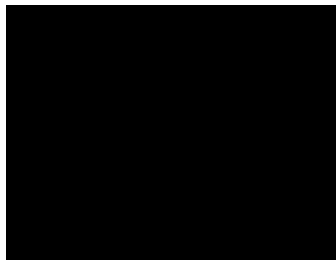



## Product Specification

	Model: GVTV57TPAF2R0	Rev. No.	Issued Date.	Page.
		A	2013,12,17	9 / 25

### 3.3 AC Timing Characteristic of The LCD

#### 3.3.1 Timing Condition

Parameter	Symbol	Min.	Typ.	Max.	Unit.	Remark
CLK frequency	$F_{CPH}$	22.66	25.175	27.69	MHZ	
CLK period	$T_{CPH}$	36.11	39.7	44.13	ns	
CLK pulse duty	$T_{CWH}$	40	50	60	%	
HS period	$T_H$	750	800	850	$T_{CPH}$	
HS pulse width	$T_{WH}$	5	30	--	$T_{CPH}$	
HS-first horizontal data time	$T_{HS}$	112	144	175	$T_{CPH}$	
Display period	$T_{HA}$	--	640	--	$T_{CPH}$	
HS setup time	$T_{HST}$	10	--	--	ns	
HS hold time	$T_{HHD}$	10	--	--	ns	
VS pulse width	$T_{WV}$	1	3	5	$T_H$	
First line data input time	$T_{STV}$	--	35	--	$T_H$	
VS period	$T_V$	515	525	535	$T_H$	
VS setup time	$T_{VST}$	10	--	--	ns	
VS hold time	$T_{VHD}$	10	--	--	ns	

Note : When SYNC mode is used, 1st data start from 144th CLK after HS falling (when  $STHD[5:0]=00000$ )

(DE mode)

Parameter	Symbol	Min.	Typ.	Max.	Unit.	Remark
DEN Period	$T_{DEN}$	--	800	--	$T_{CPH}$	
DEN pulse width	$T_{EP}$	--	640	--	$T_{CPH}$	
DEN frame active time	$T_{DEA}$	--	480	--	$T_{DEN}$	
DEN frame blanking time	$T_{DEB}$	--	45	--	$T_{DEN}$	
DEN setup time	$T_{ESU}$	10	--	--	ns	

# Product Specification



Model: GVTV57TPAF2R0

Rev. No.	Issued Date.	Page.
A	2013,12,17	10 / 25

### 3.3.2 Clock and Data input waveforms

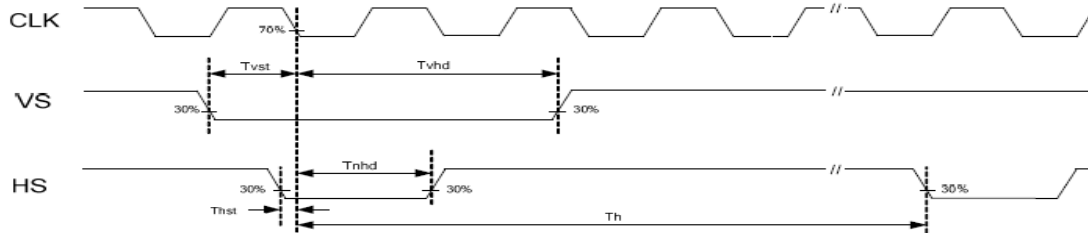
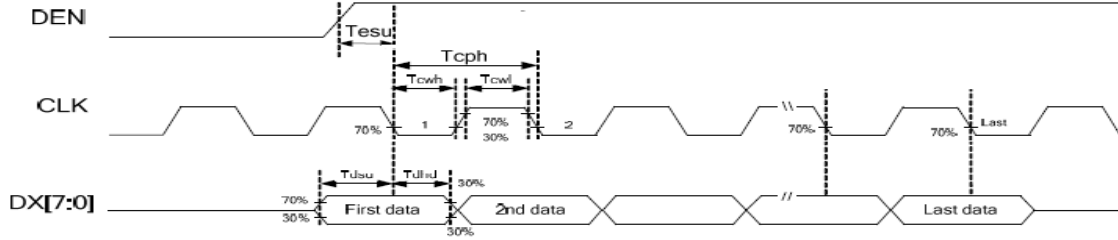

### 3.3.3 Parallel RGB SYNC Mode Horizontal Data Format

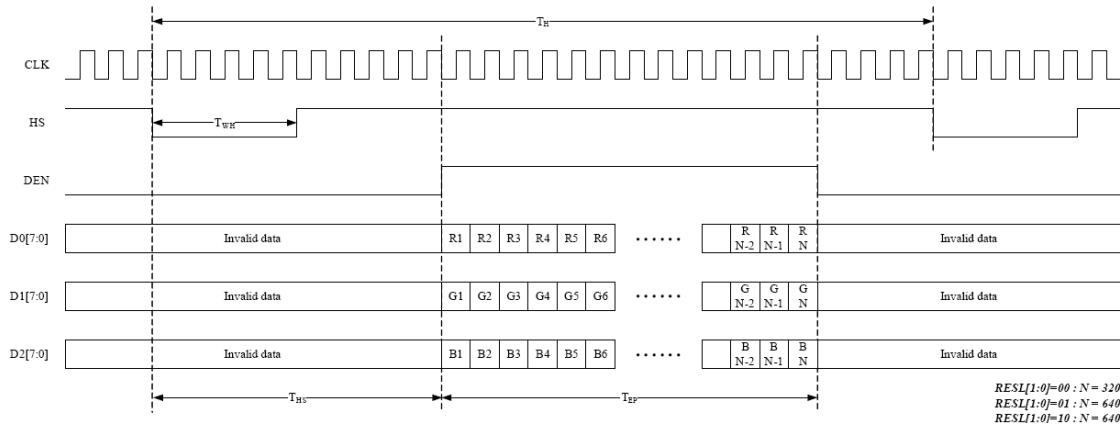

### 3.3.4 Parallel RGB DEN Mode Horizontal Data Format.

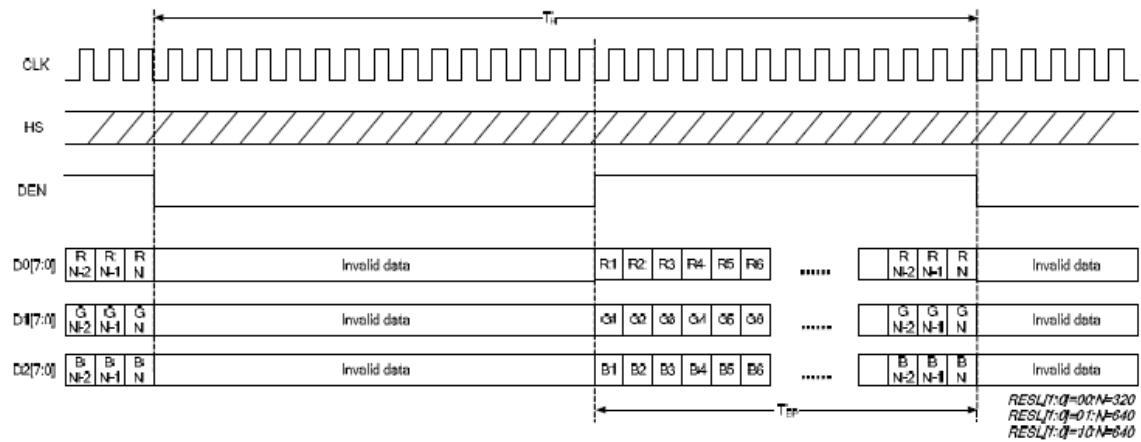

## Product Specification

	Model: GVTV57TPAF2R0	Rev. No.	Issued Date.	Page.
		A	2013,12,17	11 / 25

### 3.4 Back-Light Unit

The Back-light system is an edge-lighting type with 30 white LEDs(Light Emitting Diode).

The characteristics of 30 white LEDs are shown in the following tables.

(Ta= Room Temp)

Characteristics	Symbol	Min.	Typ.	Max.	Unit	Note
Current of Back-light Unit	$I_B$	-	200	250	mA	(1)
Voltage of Back-light Unit	$V_B$	-	(9.6)	(10.5)	V	
Power Consumption	$P_{BL}$	-	(1920)	(2625)	mW	(2)
LED Life Time	25°C	-	(30000)		hr	(3)

Note (1) LEDS in 3 series x 10 parallel type.

(2) Where  $I_B = 200\text{mA}$ ,  $V_B = 9.6$ ,  $P_{BL} = V_B \times I_B$

(3) The environmental conducted under ambient air flow ,at  $T_a=25\pm 2^\circ\text{C}$ ,60%RH $\pm 5\%$

## Product Specification

	Model: GVTV57TPAF2R0	Rev. No.	Issued Date.	Page.
		A	2013,12,17	12 / 25

### 4 Optical Characteristics

#### 4.1 Optical characteristic of the LCD

The following items are measured under stable conditions. The optical characteristics should be measured in a dark room or equivalent state.

Measuring equipment: BM-5A ,BM-7

Item	Symbol	Condition	Min	Typ	Max	Unit	Note
Brightness			560	(720)	--	cd/m <sup>2</sup>	
Response time	T <sub>r</sub>	θ=0°	-	15	20	ms	.
	T <sub>f</sub>		--	25	35	ms	
Contrast ratio	CR	At optimized viewing angle	400	(500)	--	--	
Color Gamut	NTSC %	--	--	50	--	%	
Luminance Uniformity	ΔL		80	85		%	
Color Chromaticity (CIE 1931)	Red	R <sub>x</sub>	θ=0° Normal Viewing Angle	0.565	0.615	0.665	--
		R <sub>y</sub>		0.294	0.344	0.394	
	Green	G <sub>x</sub>		0.257	0.307	0.357	--
		G <sub>y</sub>		0.512	0.562	0.612	
	Blue	B <sub>x</sub>		0.090	0.140	0.190	--
		B <sub>y</sub>		0.080	0.130	0.180	
	White	W <sub>x</sub>		0.259	0.309	0.359	--
		W <sub>y</sub>		0.300	0.350	0.400	
Viewing Angle (6H)	Hor.	θ <sub>R</sub>	CR≥10	55	65	--	Degree
		θ <sub>L</sub>		55	65	--	
	Ver.	φ <sub>H</sub>		40	50	--	
		φ <sub>L</sub>		55	65	--	

## Product Specification



Model: GVTV57TPAF2R0

Rev. No.

Issued Date.

Page.

A

2013,12,17

13 / 25

a. Test equipment setup

After stabilizing and leaving the panel alone shall be warmed up for the stable operation of LCM, the measurement should be executed. Measurement should be executed in a stable, windless, and dark room. Optical specifications are measured by Topcon BM-7(fast) with a viewing angle of 2° at a distance of 50cm and normal direction.

b. Definition of response time: Tr and Tf

The response time is defined as the following figure and shall be measured by switching the input signal for "black" and "white".

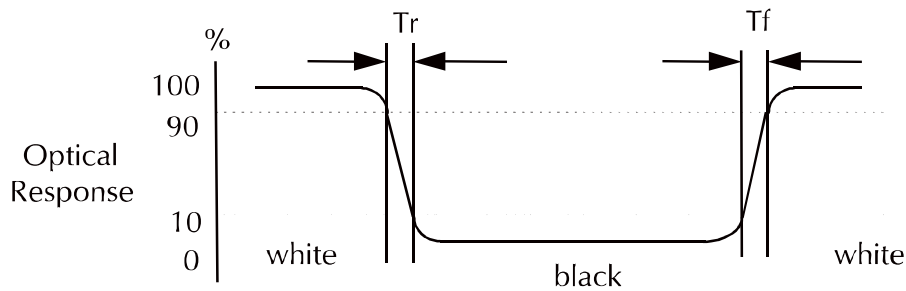

c. Definition of contrast ratio:

$$\text{Contrast Ratio (CR)} = \frac{\text{Brightness measured when LCD is at "white state"}}{\text{Brightness measured when LCD is at "black state"}}$$

d. Measured at the center area of the panel when all the input terminals of LCD panel are electrically opened.

## Product Specification



Model: GVTV57TPAF2R0

Rev. No.

Issued Date.

Page.

A

2013,12,17

14 / 25

e. View Angle

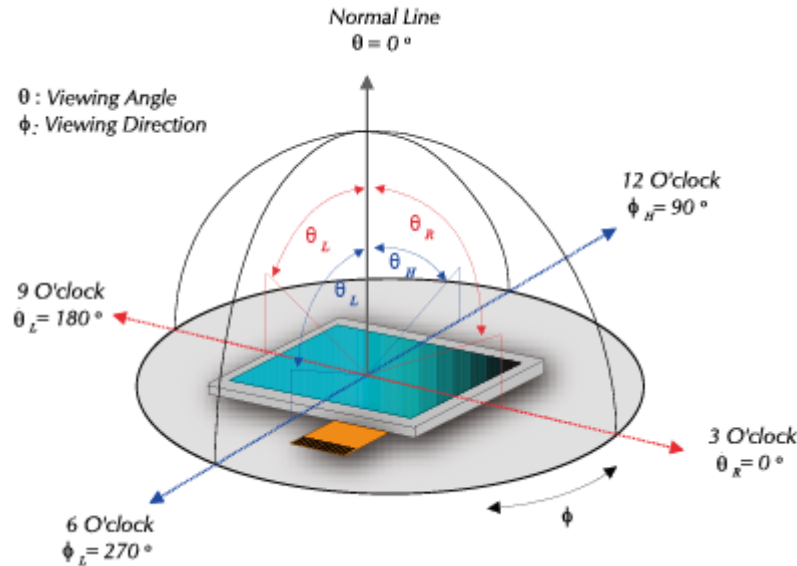

f. Definition of Luminance of White: Luminance of white at the center points

Light Source of Back-Light Unit	LED Type
---------------------------------	----------

g. Definition of White Uniformity

$$\text{White Uniformity} = \frac{\text{Min. luminance of white among 9-points}}{\text{Max. luminance of white among 9-points}}$$

h. The definition of Color Gamut -Color Chromaticity CIE 1931

Color coordinate of white & red, green, blue at center point.

$$\text{Color Gamut : NTSC(\%)} = (\text{RGB Triangle Area} / \text{NTSC Triangle Area}) \times 100$$

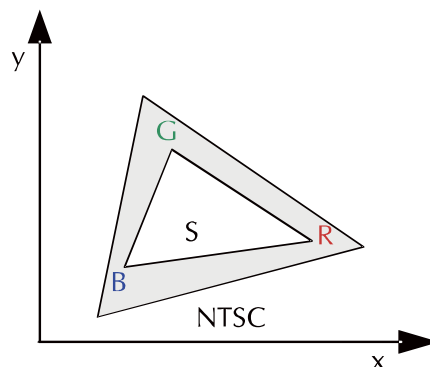

## Product Specification

	Model: GVTV57TPAF2R0	Rev. No.	Issued Date.	Page.
		A	2013,12,17	15 / 25

### 5 Input Terminal Pin Assignment

#### 5.1 Pin Assignment

Pin No.	Symbol	I/O	Function	Remark
1	VSS	P	GND	
2	DCLK	I	Clock signal for sampling each data signal	
3	IHS	I	Horizontal synchronous signal (Negative)	
4	IVS	I	Vertical synchronous signal (Negative)	
5	VSS	P	GND	
6	R0	I	RED data signal (LSB)	
7	R1	I	RED data signal	
8	R2	I	RED data signal	
9	R3	I	RED data signal	
10	R4	I	RED data signal	
11	R5	I	RED data signal (MSB)	
12	VSS	P	GND	
13	G0	I	GREEN data signal (LSB)	
14	G1	I	GREEN data signal	
15	G2	I	GREEN data signal	
16	G3	I	GREEN data signal	
17	G4	I	GREEN data signal	
18	G5	I	GREEN data signal (MSB)	
19	VSS	P	GND	
20	B0	I	BLUE data signal(LSB)	
21	B1	I	BLUE data signal	
22	B2	I	BLUE data signal	
23	B3	I	BLUE data signal	
24	B4	I	BLUE data signal	
25	B5	I	BLUE data signal(MSB)	
26	VSS	P	GND	
27	DEN	I	Signal to settle the horizontal display position (Positive)	
28	VCC	P	3.3V power supply	
29	VCC	P	3.3V power supply	
30	REV	I	Select horizontal and vertical scanning direction.	Note5-1
31	VSS	P	GND	
32	NC	--	No Connection	
33	VSS	P	GND	

## Product Specification

	Model: GVTV57TPAF2R0	Rev. No.	Issued Date.	Page.
		A	2013,12,17	16 / 25

Note 5 - 1

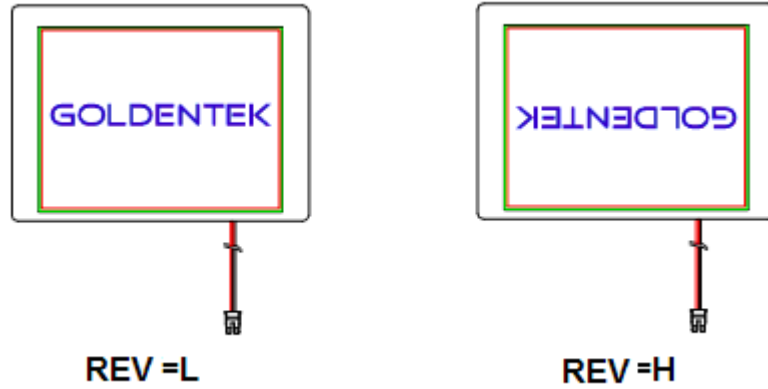

### 5.2 Back-light Unit (BLU)

Pin No.	Symbol	Function	Remark
1	LEDA	Power Supply for LED backlight	Red
2	LEDK	GND for LED backlight	Black

Connector: JST BHSR-02VS-1



Product Specification				
	Model: GVTV57TPAF2R0	Rev. No.	Issued Date.	Page.
		A	2013,12,17	17 / 25

5.3 Block Diagram

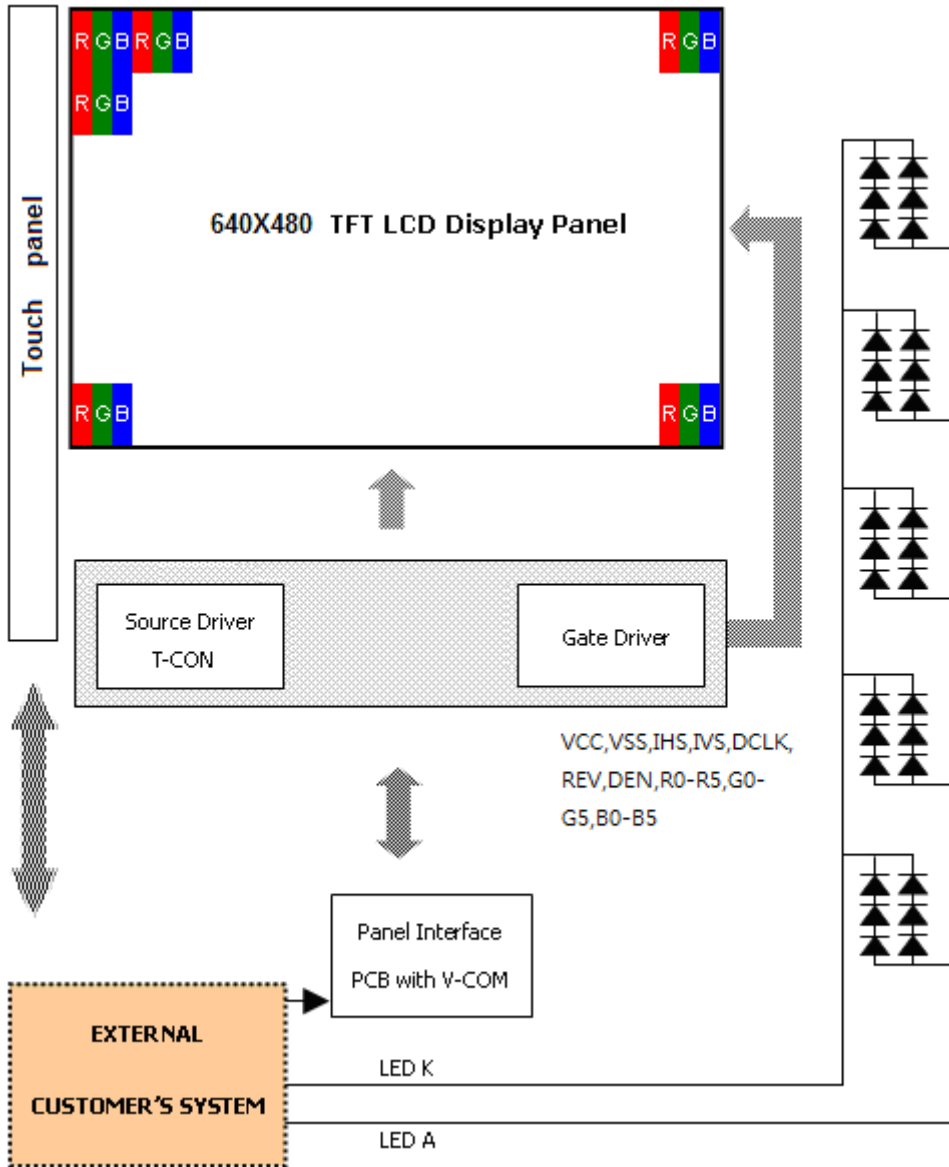

## Product Specification

	Model: GVTV57TPAF2R0	Rev. No.	Issued Date.	Page.
		A	2013,12,17	18 / 25

### 5.4 Basic Display Color and Gray Scale

	Color & Gray Scale	Data Signal																	
		R5	R4	R3	R2	R1	R0	G5	G4	G3	G2	G1	G0	B5	B4	B3	B2	B1	B0
Basic Color	Black	0	0	0	0	0	0	0	0	0	0	0	0	0	0	0	0	0	0
	Red(0)	1	1	1	1	1	1	0	0	0	0	0	0	0	0	0	0	0	0
	Green(0)	0	0	0	0	0	0	1	1	1	1	1	1	0	0	0	0	0	0
	Blue(0)	0	0	0	0	0	0	0	0	0	0	0	0	1	1	1	1	1	1
	Cyan	0	0	0	0	0	0	1	1	1	1	1	1	1	1	1	1	1	1
	Magenta	1	1	1	1	1	1	0	0	0	0	0	0	1	1	1	1	1	1
	Yellow	1	1	1	1	1	1	1	1	1	1	1	1	0	0	0	0	0	0
	White	1	1	1	1	1	1	1	1	1	1	1	1	1	1	1	1	1	1
Red	Black	0	0	0	0	0	0	0	0	0	0	0	0	0	0	0	0	0	0
	Red(1)	0	0	0	0	0	1	0	0	0	0	0	0	0	0	0	0	0	0
	Red(2)	0	0	0	0	1	0	0	0	0	0	0	0	0	0	0	0	0	0
	:	:	:	:	:	:	:	:	:	:	:	:	:	:	:	:	:	:	:
	Red(31)	0	1	1	1	1	1	0	0	0	0	0	0	0	0	0	0	0	0
	:	:	:	:	:	:	:	:	:	:	:	:	:	:	:	:	:	:	:
	Red(62)	1	1	1	1	1	0	0	0	0	0	0	0	0	0	0	0	0	0
	Red(63)	1	1	1	1	1	1	0	0	0	0	0	0	0	0	0	0	0	0
Green	Black	0	0	0	0	0	0	0	0	0	0	0	0	0	0	0	0	0	0
	Green(1)	0	0	0	0	0	0	0	0	0	0	0	1	0	0	0	0	0	0
	Green(2)	0	0	0	0	0	0	0	0	0	0	1	0	0	0	0	0	0	0
	:	:	:	:	:	:	:	:	:	:	:	:	:	:	:	:	:	:	:
	Green(31)	0	0	0	0	0	0	0	1	1	1	1	1	0	0	0	0	0	0
	:	:	:	:	:	:	:	:	:	:	:	:	:	:	:	:	:	:	:
	Green(62)	0	0	0	0	0	0	1	1	1	1	1	0	0	0	0	0	0	0
	Green(63)	0	0	0	0	0	0	1	1	1	1	1	1	0	0	0	0	0	0
Blue	Black	0	0	0	0	0	0	0	0	0	0	0	0	0	0	0	0	0	0
	Blue(1)	0	0	0	0	0	0	0	0	0	0	0	0	0	0	0	0	0	1
	Blue(2)	0	0	0	0	0	0	0	0	0	0	0	0	0	0	0	0	1	0
	:	:	:	:	:	:	:	:	:	:	:	:	:	:	:	:	:	:	:
	Blue(31)	0	0	0	0	0	0	0	0	0	0	0	0	0	1	1	1	1	1
	:	:	:	:	:	:	:	:	:	:	:	:	:	:	:	:	:	:	:
	Blue(62)	0	0	0	0	0	0	0	0	0	0	0	0	1	1	1	1	1	0
	Blue(63)	0	0	0	0	0	0	0	0	0	0	0	0	1	1	1	1	1	1

0 : Low level voltage, 1 :High level voltage

Each basic color can be displayed in 64 gray scales from 6 bit data signals. With the combination of total 18 bit data signals, the 262,144-color display can be achieved on the screen.

## Product Specification

	Model: GVTV57TPAF2R0	Rev. No.	Issued Date.	Page.
		A	2013,12,17	19 / 25

### 6 Touch screen panel

#### 6.1 Electrical Characteristics

Item	Min.	Typ.	Max.	Unit	Note
Linearity	-	-	1.5	%	Analog X and Y directions
Terminal resistance	200	-	900	$\Omega$	X
	200	-	900	$\Omega$	Y
Insulation resistance	20	-	-	M $\Omega$	DC 25V
Voltage	-	5.0	10	V	DC
Chattering	-	-	10	ms	100k $\Omega$ pull-up
Transparency	-	80	-	%	Glare & hard coating

#### 6.2 Mechanical & Reliability Characteristics

Item	Min.	Typ.	Max.	Unit	Note
Operation force	-	60	100	g	
Tapping durability	1,000,000	-	-	times	
Pen sliding durability	100,000				
Surface hardness	3	-	-	H	According to (JIS-K5400)

#### 6.3 Touch Panel Unit

Pin No.	Symbol	Function	Remark
1	YU	Touch panel Top	
2	XR	Touch panel Right	
3	YD	Touch panel Bottom	
4	XL	Touch panel Left	

## Product Specification

	Model: GVTV57TPAF2R0	Rev. No.	Issued Date.	Page.
		A	2013,12,17	20 / 25

### 7 Reliability Condition

No change on display and in operation under the following test condition.

Condition: Unless otherwise specified, tests will be conducted under the following condition.

Temperature: 20±5°C                      Humidity: 65±5%RH

Tests will be not conducted under functioning state.

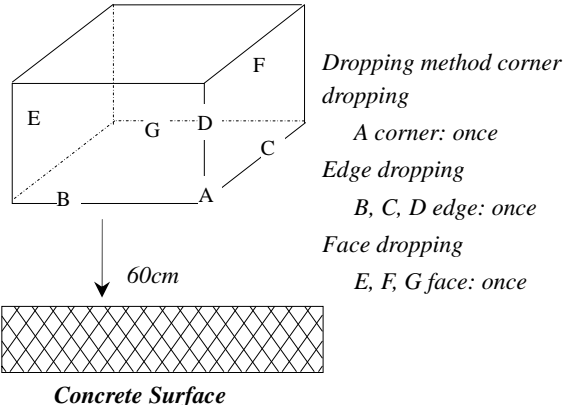
No.	Parameter	Condition	Notes
1	High Temperature Operating	80°C±2°C, 240hrs (Operation state)	-
2	Low Temperature Operating	-30°C±2°C, 240hrs (Operation state)	-
3	High Temperature Storage	80°C±2°C, 240hrs	-
4	Low Temperature Storage	-30°C±2°C, 240hrs	-
5	High Temperature and High Humidity Operation Test	60°C±2°C, 90%, 240hrs.	-
6	Vibration Test	Total fixed amplitude: 1.5mm Vibration Frequency: 10~55Hz One cycle 60 seconds to 3 direction of X, Y, Z each 15 minutes.	-
7.	Drop Test	<p>To be measured after dropping from 60cm high on the concrete surface in packing state.</p> <div style="text-align: center;">  </div>	-

# Product Specification



Model: GVTV57TPAF2R0

Rev. No.	Issued Date.	Page.
A	2013,12,17	21 / 25

## 8 Dimensional Outlines

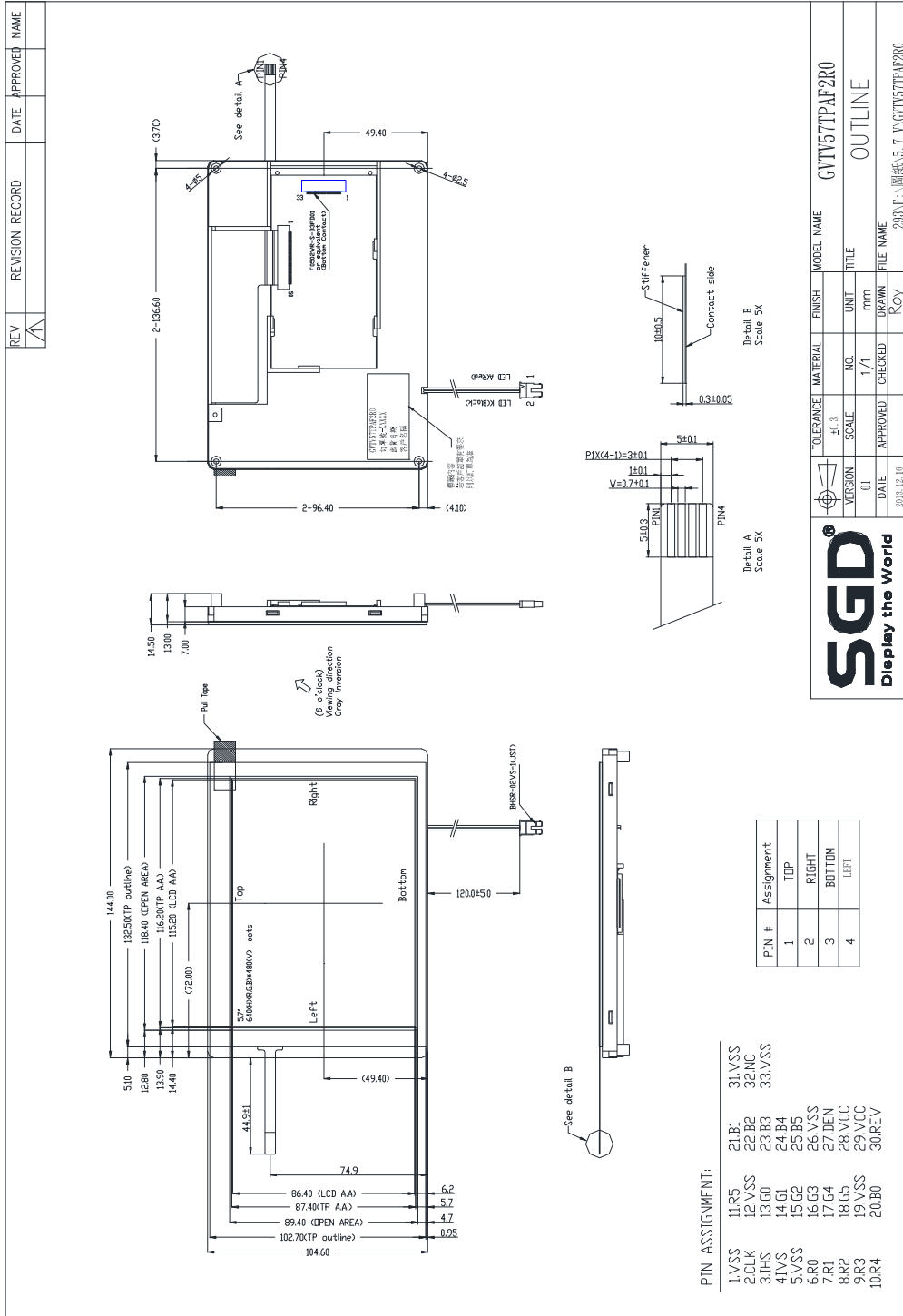

Product Specification				
	Model: GVTV57TPAF2R0	Rev. No.	Issued Date.	Page.
		A	2013,12,17	22 / 25

## 9 Incoming Inspection Standards

### 9.1 Inspection and Environment Conditions

#### 9.1.1 Inspection Conditions:

- (1) Inspection Distance: 35 cm±5cm
- (2) View Angle : Light-on Inspection Angle : ±5°  
Cosmetic Inspection Angle : ±45°

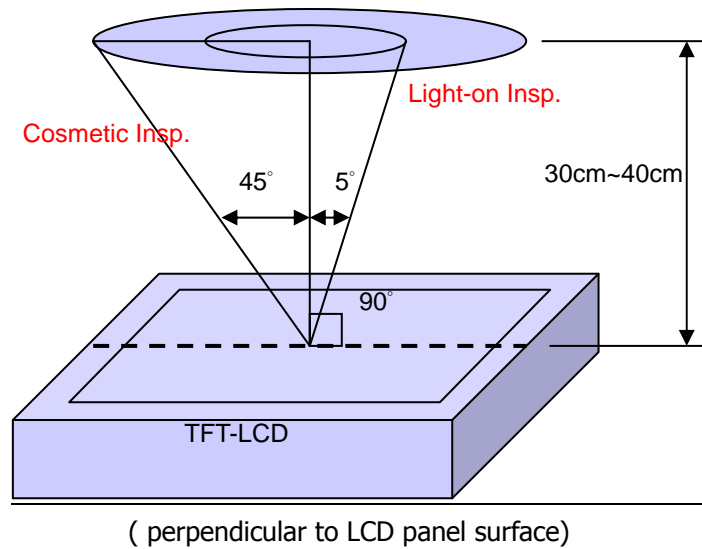

#### 9.1.2 Environment Conditions:

Ambient Temperature		23°C ±5°C
Ambient Humidity		55±10%RH
Ambient Illumination	Cosmetic Inspection	more than 600 Lux
	Functional Inspection	300~500 Lux

#### 9.1.3 Sampling Conditions:

- (1) Lot Size: Quantity of shipment lot per model
- (2) Sampling Method:

Sampling Plan		MIL-STD-105E
		Normal Inspection, Single Sampling
		Level II
AQL	Major Defect	1.0%
	Minor Defect	1.5%

(3) The classification of Major(MA) and Minor(MI) defects is shown as 3. Inspection Criteria.

## Product Specification



Model: GVTV57TPAF2R0

Rev. No.

Issued Date.

Page.

A

2013,12,17

23 / 25

### 9.1.4 Inspection Criteria

#### 9.1.4.1 Cosmetic Inspection(Panel):

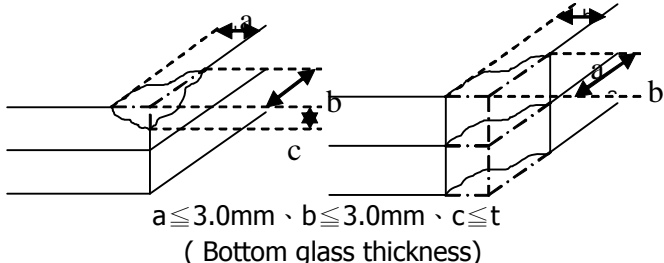
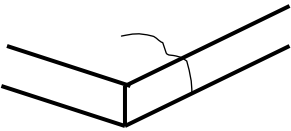
Item	Judgment Criteria	Classification
Chipping on Panel	 <p><math>a \leq 3.0\text{mm} \cdot b \leq 3.0\text{mm} \cdot c \leq t</math> ( Bottom glass thickness)</p>	MA
Scratch on Panel *Note-2	$W \leq 0.05\text{mm}$ or $L < 5\text{mm}$ : Ignored $0.05\text{mm} < W \leq 0.1\text{mm}$ and $L \leq 5\text{mm}$ : $N \leq 5$ $W > 0.1\text{mm}$ or $L > 5\text{mm}$ : Not allowed	MI
Bubble or Dent on Panel *Note-3	$D \leq 0.2\text{mm}$ : Ignored $0.2\text{mm} < D \leq 0.3\text{mm}$ : $N \leq 5$ $D > 0.3\text{mm}$ : Not allowed	MI
Panel Crack	 <p>Not Allowed crack</p>	MA
Bezel Deformation	Obvious deformation is not allowed.	MI
Bezel Oxidation	Not allowed if it rusts continuously over 1 cm (It is out of warranty with rusted tin plate)	MI
Bezel Scratch	$L \leq 20\text{mm}$ , $W \leq 0.2$ , $N \leq 3$	MI
Metal Squash Dent /Flange(Front Side)	$D(W) \leq 1, L \leq 3, N \leq 3;$	MI
B/L High Voltage Wire Denudation	Not allowed	MA
Polarizer flaw or leak out resin	Defect is defined as the active area.	MI
Outline Dimension	Must in Spec, refer to related product spec.	MI

Product Specification			
	Model: GVTV57TPAF2R0	Rev. No.	Issued Date.
		A	2013,12,17
			Page.
			24 / 25

9.1.4.2 Functional Inspection:

Item	Judgment Criteria			Classification
	Area(Note1)	I	O	
Point Defect	Bright dot	Random	2	
		2 dots adjacent	0	0
		3 dots adjacent or more	0	0
	Dark dot	Random	3	
		2 dots adjacent	0	
		3 dots adjacent or more	0	0
	Total Dot Defect		5	
	Distance	Distance between Bright and Bright dot	$L \geq 5\text{mm}$	
		Distance between Bright and Dark dot	$L \geq 5\text{mm}$	
		Distance between Dark dot	$L \geq 5\text{mm}$	
(1) It is defined as Point Defect if defect area $> 0.5\text{dot}$ (2) It is ignored if defect area $\leq 0.5\text{dot}$ (3) Weak point defect will be defined as Bright Dot if it can be observed through ND filter 5%( Full Screen Black Inspection)				MI
Line Defect	Obvious vertical or horizontal line defect is not allowed.			MA
Mura	Not allowed if it can be observed through ND Filter 5 %			MI
Foreign Material in spot shape *Note-3	$D \leq 0.2\text{mm}$ : Ignored $0.2\text{mm} < D \leq 0.5\text{mm}$ : $N \leq 8$ $D > 0.5\text{mm}$ : Not allowed			MI
Foreign Material in line or spiral shape *Note-4	$W \leq 0.05\text{mm}$ or $L \leq 5\text{mm}$ : Ignored $0.05\text{mm} < W \leq 0.2\text{mm}$ and $L 1.0\text{mm} \leq 5\text{mm}$ : $N \leq 8$ $W > 0.2\text{mm}$ or $L > 5\text{mm}$ : Not allowed			MI
Display Function Abnormal	No Malfunction can be allowed			MA



## Product Specification



Model: GVTV57TPAF2R0

Rev. No.

Issued Date.

Page.

A

2013,12,17

25 / 25

Note-1 : I/O Area Definition

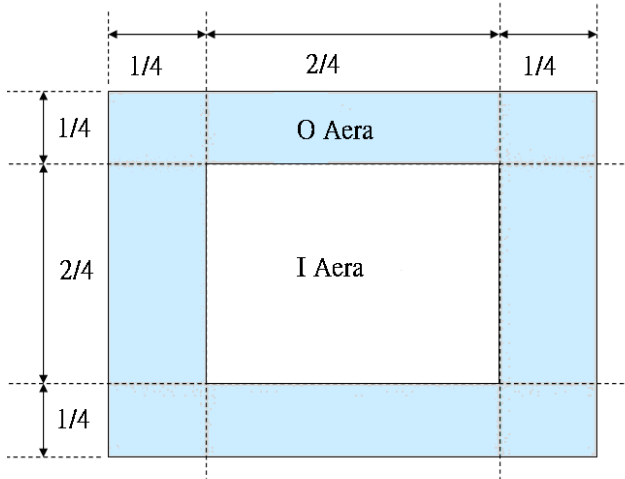

Note-2 : Polarizer Scratch

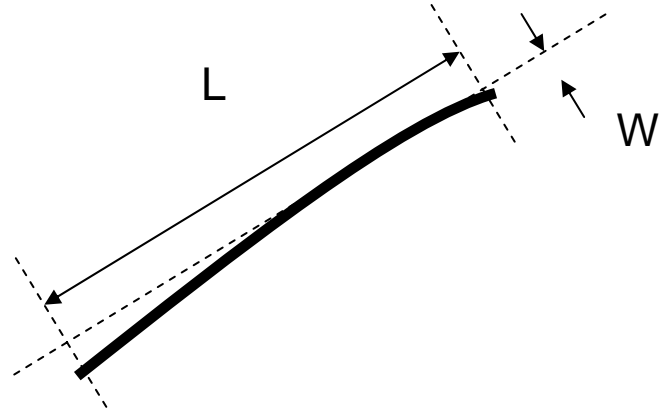

Note-3 : Spot Foreign Material  
( $W \geq L / 4$ )

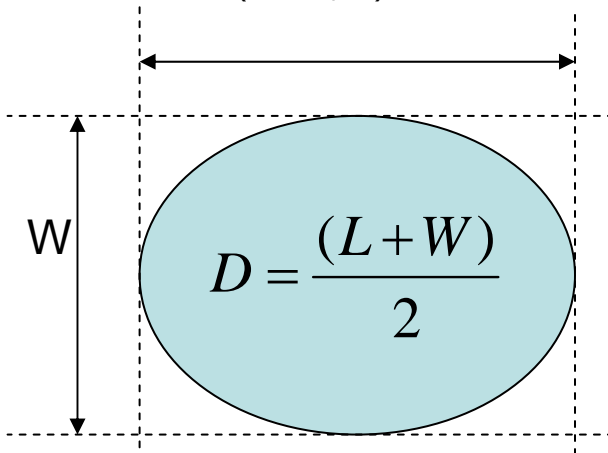

Note-4 : Line or Spiral Foreign Material  
( $W < L / 4$ )

