

ULTRA LOW CAPACITANCE STEERING DIODE/TVS ARRAY



DESCRIPTION

The PAM04ST430502 is an ultra low capacitance (0.6pF) steering diode and TVS array combo. This device provides circuit protection for automotive applications. The PAM04ST430502 is ideally suited to protect USB data I/O ports against the effects of ESD and EFT.

The PAM04ST430502 meets the requirements of IEC 61000-4-2 (ESD) and IEC 61000-4-4 (EFT). At higher operating frequencies or faster edge rates, insertion loss and signal integrity are a major concern. The PAM04ST430502 offers a ultra low capacitance and low leakage current in a SOT-543 package.

FEATURES

- Compatible with IEC 61000-4-2 (ESD): Air - 15kV, Contact - 8kV
- Compatible with IEC 61000-4-4 (EFT): 40A - 5/50ns
- Compatible with IEC 61000-4-5 (Surge): 24A, 8/20 μ s - Level 2(Line-Gnd) & Level 3(Line-Line)
- 200 Watts Peak Pulse Power per Line (tp = 8/20 μ s)
- ESD Protection > 25 kilovolts
- Low Clamping Voltage
- Unidirectional Configuration
- Protects 2 I/O Ports and Power Supply
- Ultra Low Capacitance: 0.6pF
- RoHS Compliant
- REACH Compliant

APPLICATIONS

- Automotive Applications

MECHANICAL CHARACTERISTICS

- Molded JEDEC SOT-543 Package
- Approximate Weight: 3 milligrams
- Lead-Free Pure-Tin Plating (Annealed)
- Solder Reflow Temperature:
Pure-Tin - Sn, 100: 260-270°C
- 8mm Tape and Reel Per EIA Standard 481
- Flammability Rating UL 94V-0

PIN CONFIGURATION

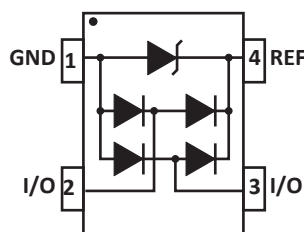

TYPICAL DEVICE CHARACTERISTICS
MAXIMUM RATINGS @ 25°C Unless Otherwise Specified

PARAMETER	SYMBOL	VALUE	UNITS
Operating Temperature	T_L	-55 to 150	°C
Storage Temperature	T_{STG}	-55 to 150	°C
Peak Pulse Power (tp = 8/20μs) - See Figure 1	P_{PP}	200	Watts
Peak Forward Voltage - $I_F = 1A$, 8/20μs	V_F	1.5	Volts

ELECTRICAL CHARACTERISTICS PER LINE @ 25°C Unless Otherwise Specified

PART NUMBER	DEVICE MARKING	RATED STAND-OFF VOLTAGE V_{WM} VOLTS	MINIMUM BREAKDOWN VOLTAGE @1mA $V_{(BR)}$ VOLTS	MAXIMUM CLAMPING VOLTAGE (Fig. 2) (Note 2) @ $I_P = 1A$ V_C VOLTS	MAXIMUM CLAMPING VOLTAGE (Fig. 2) (Note 2) @ 8/20μs $V_C @ I_{PP}$	MAXIMUM LEAKAGE CURRENT @ V_{WM} I_D μA	MAXIMUM CAPACITANCE (Per Data Line) (Fig. 5) (Note 1) @0V, 1MHz $C_{J(SD)}$ pF
PAM04ST430502	B5	5.0	6.0	9.8	20.0V @ 10.0A	1	0.6

NOTE

- As shown in Figure 5, REF 1 is connected to ground, REF 2 is connected to + V_{CC} and input applies to $V_{CC} = 5V$, $V_{SIGN} = 30mV$, $F = 1MHz$.
- Measured across pin 1 to pin 4.

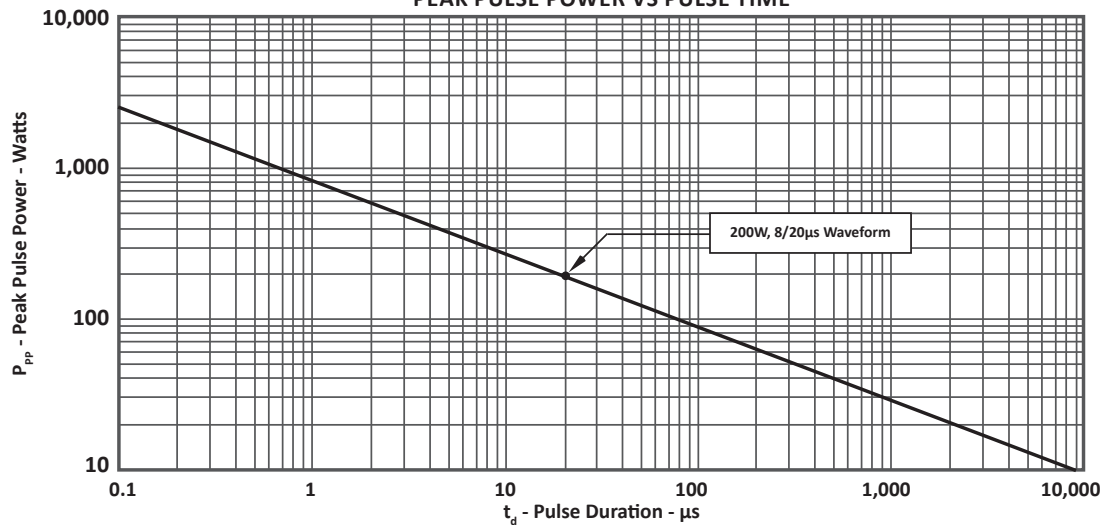
**FIGURE 1
PEAK PULSE POWER VS PULSE TIME**

TYPICAL DEVICE CHARACTERISTICS

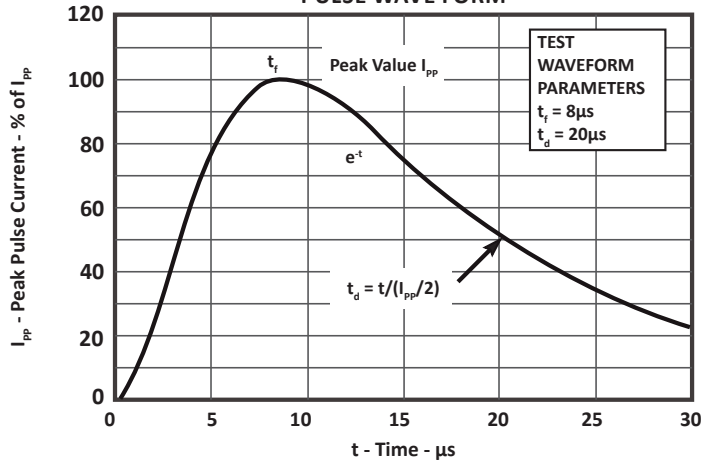
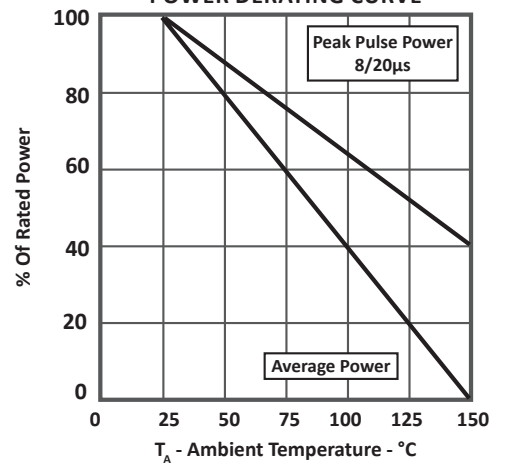
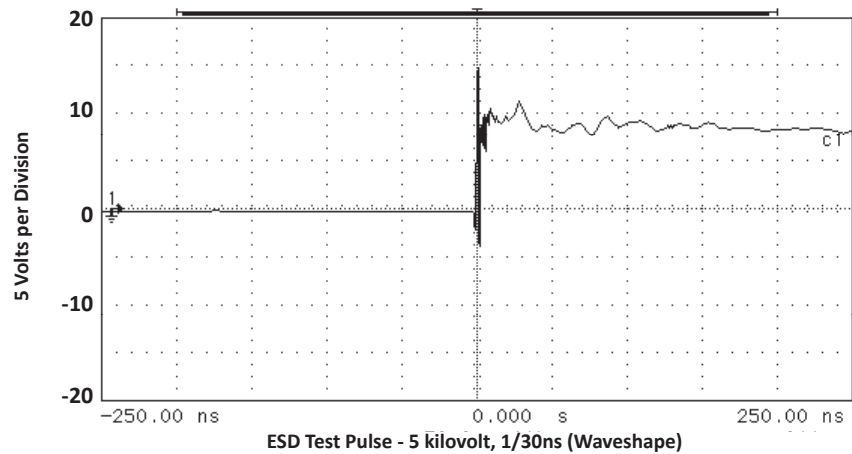
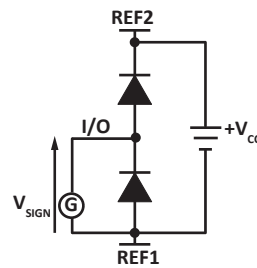
FIGURE 2
PULSE WAVE FORM

FIGURE 3
POWER DERATING CURVE

FIGURE 4
OVERSHOOT & CLAMPING VOLTAGE

FIGURE 5
INPUT CAPACITANCE CIRCUIT

SOT-543 PACKAGE INFORMATION
OUTLINE DIMENSIONS

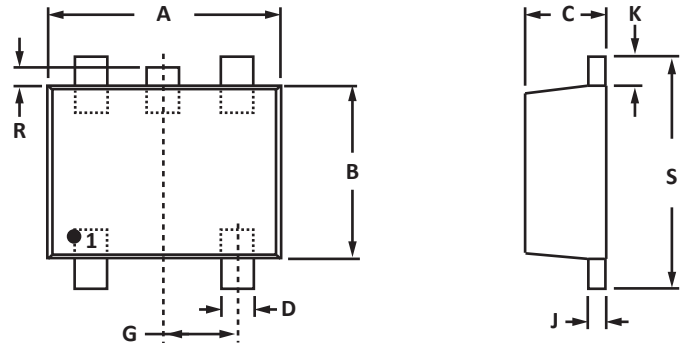
DIM	MILLIMETERS		INCHES	
	MIN	MAX	MIN	MAX
A	1.50	1.70	0.059	0.067
B	1.10	1.30	0.043	0.051
C	0.50	0.60	0.020	0.024
D	0.17	0.27	0.007	0.011
G	0.50 BSC		0.020 BSC	
J	0.08	0.18	0.003	0.007
K	0.10	0.30	0.004	0.012
S	1.50	1.70	0.059	0.067
R	0.05	0.15	0.002	0.006

NOTES

1. Controlling dimension: inches.
2. Dimensioning and tolerances per ANSI Y14.5M, 1985.
3. Dimensions are exclusive of mold flash and metal burrs.
4. Do not connect center stub.

PAD LAYOUT DIMENSIONS

DIM	MILLIMETERS	INCHES
	NOMINAL	NOMINAL
A	1.02	0.040
B	1.20	0.048
C	0.30	0.012
D	0.51	0.020

NOTES

1. Controlling dimension: inches.

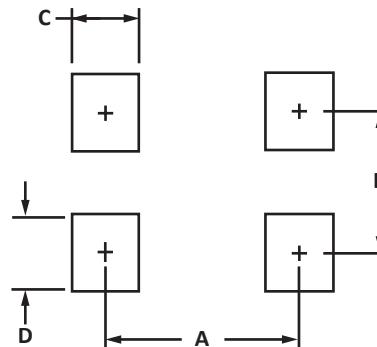

TAPE AND REEL

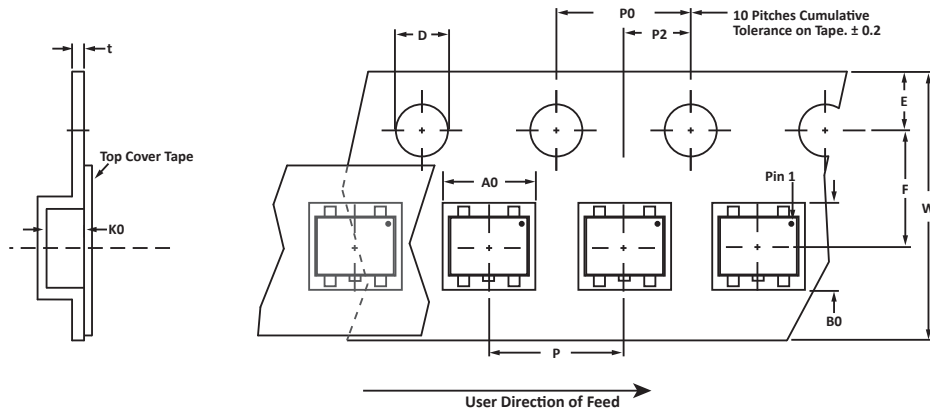

SPECIFICATIONS

REEL DIA.	TAPE WIDTH	A0	B0	K0	D	E	F	W	P0	P2	P	tmax
178mm (7")	8mm	1.78 ± 0.05	1.78 ± 0.05	0.69 ± 0.05	1.50 ± 0.10	1.75 ± 0.10	3.50 ± 0.05	8.00 ± 0.30	4.00 ± 0.10	2.00 ± 0.05	4.00 ± 0.10	0.25

NOTES

- Dimensions are in millimeters.
- Surface mount product is taped and reeled in accordance with EIA-481.
- Suffix - T7 = 7" Reel - 3,000 pieces per 8mm tape.
- Marking on Part - marking code (see page 2).

Package outline, pad layout and tape specifications per document number 06074.R3 3/11.

ORDERING INFORMATION

BASE PART NUMBER	LEADFREE SUFFIX	TAPE SUFFIX	QTY/REEL	REEL SIZE	TUBE QTY
PAM04ST430502-NQ	n/a	-T7	3,000	7"	n/a

This device is only available in a Lead-Free configuration.

Suffix -NQ = This is a commercial grade device and is not qualified to the AEC-Q101 standard. Please contact customer service for more information.

COMPANY INFORMATION

COMPANY PROFILE

In business more than 20 years, ProTek Devices™ is a privately-held company located in Tempe, Arizona, that offers a product line of transient voltage suppressors (TVS); avalanche breakdown diodes; steering diode TVS arrays and other surge suppressor component products. These TVS devices protect electronic systems from the effects of lightning, electrostatic discharge (ESD), nuclear electromagnetic pulses (NEMP), inductive switching and EMI / RFI. ProTek Devices also offers high performance interface and linear products that include analog switches; multiplexers; LED drivers; audio control ICs; RF and related high frequency products. The analog devices work in a host of consumer; industrial; automotive and other applications.

CONTACT US

Corporate Headquarters

2929 South Fair Lane
Tempe, Arizona 85282
USA

By Telephone

General: 602-431-8101
Sales: & Marketing: 602-414-5109
Customer Service: 602-414-5114
Product Technical Support: 602-414-5107

By Fax

General: 602-431-2288

By E-mail:

Sales: sales@protekdevices.com
Customer Service: service@protekdevices.com
Technical Support: support@protekdevices.com

ProTek Devices (Asia Pacific) Pte. Ltd.

8 Ubi Road 2, #06-19
Zervex
Singapore - 408538
Tel: +65-67488312
Fax: +65-67488313

Web

www.protekdevices.com

COPYRIGHT © ProTek Devices 2011 - This literature is subject to all applicable copyright laws and is not for resale in any manner.

SPECIFICATIONS: ProTek reserves the right to change the electrical and or mechanical characteristics described herein without notice.

DESIGN CHANGES: ProTek reserves the right to discontinue product lines without notice and that the final judgement concerning selection and specifications is the buyer's and that in furnishing engineering and technical assistance. ProTek assumes no responsibility with respect to the selection or specifications of such products. ProTek makes no warranty, representation or guarantee regarding the suitability of its products for any particular purpose, nor does ProTek assume any liability arising out of the application or use of any product or circuit and specifically disclaims any and all liability without limitation special, consequential or incidental damages.

LIFE SUPPORT POLICY: ProTek Devices products are not authorized for use in life support systems without written consent from the factory.