

PRODUCT SPECIFICATION

DATE : 05/02/2011

| | | | |
|---|--|--------------|--------|
| cosmo ELECTRONICS CORPORATION | SOLID STATE RELAY - MOSFET OUTPUT KAQV214S | NO.62M10005 | REV. 2 |
| | | SHEET 1 OF 7 | |

● OUTSIDE DIMENSION :

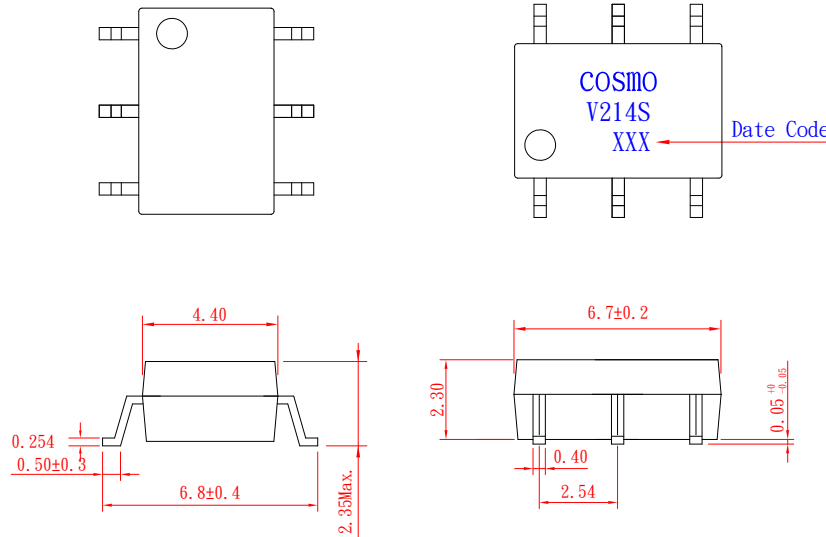

● Turn On / Turn Off time

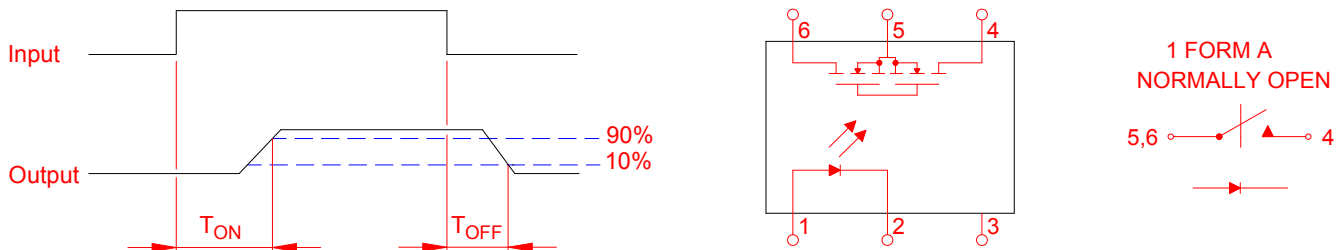

● Absolute Maximum Ratings

(Ta=25°C)

| Emitter (Input) | Detector (Output) |
|--|---|
| Reverse Voltage 5.0V | Output Breakdown Voltage ± 400V |
| Continuous Forward Current 50mA | Continuous Load Current ± 130mA |
| Peak Forward Current 1A | Power Dissipation 500mW |
| Power Dissipation 100mW | |
| Derate Linearly from 25°C 1.3mW/°C | |
| General Characteristics | |
| Isolation Test Voltage 1500VACrms | Storage Temperature Range -40°C to +125°C |
| Isolation Resistance | Operating Temperature Range ... -40°C to +85°C |
| Vio=500V, Ta=25°C ≥ 10 ¹⁰ Ω | Junction Temperature 100°C |
| Total Power Dissipation 550mW | Soldering Temperature , |
| Derate Linearly from 25°C 2.5mW/°C | 2mm from case , 10 sec 260°C |

PRODUCT SPECIFICATION

DATE : 05/02/2011

| | | | |
|---|--|--------------|------|
| cosmo ELECTRONICS CORPORATION | SOLID STATE RELAY - MOSFET OUTPUT KAQV214S | NO.62M10005 | REV. |
| | | SHEET 2 OF 7 | 2 |

● Electro-optical Characteristics

(Ta=25°C)

| Parameter | Symbol | Conditions | Min. | Typ. | Max. | Unit. | |
|--------------------------|-------------------|---|--|------|------|---------------|----------|
| Emitter (Input) | | | | | | | |
| Forward Voltage | V_F | $I_F=10\text{mA}$ | | 1.2 | 1.5 | V | |
| Operation Input Current | $I_{F\text{ON}}$ | $V_L=\pm 20\text{V}$, $I_L=100\text{mA}$, $t=10\text{ms}$ | | | 5.0 | mA | |
| Recovery Input Current | $I_{F\text{OFF}}$ | $V_L=\pm 20\text{V}$, $I_L \leq 5\mu\text{A}$ | 0.2 | | | mA | |
| Detector (Output) | | | | | | | |
| Output Breakdown Voltage | V_B | $I_B=50\mu\text{A}$ | 350 | | | V | |
| Output Off-State Leakage | $I_{T\text{OFF}}$ | $V_T=400\text{V}$, $I_F=0\text{mA}$ | | 0.2 | 1 | μA | |
| I/O Capacitance | C_{ISO} | $I_F=0$, $f=1\text{MHz}$ | | 6 | | pF | |
| ON Resistance | Connection | A | $I_L=100\text{mA}$, $I_F=10\text{mA}$ | | 20 | 30 | Ω |
| | | B | | | 10 | 15 | |
| | | C | | | 5 | 7.5 | |
| Turn-On Time | T_{ON} | $I_F=10\text{mA}$, $V_L=\pm 20\text{V}$ | | 0.3 | 1.0 | ms | |
| Turn-Off Time | T_{OFF} | $t=10\text{ms}$, $I_L=\pm 100\text{mA}$ | | 0.7 | 1.5 | ms | |

● Schematic and Wiring Diagrams

| Schematic | Output Configuration | Load | Connection | Wiring Diagrams |
|-----------|----------------------|-------|------------|-----------------|
| | 1a | AC/DC | A | |
| | | DC | B | |
| | | | | |
| DC | C | | | |

PRODUCT SPECIFICATION

DATE : 05/02/2011

cosmo
ELECTRONICS CORPORATION

SOLID STATE RELAY - MOSFET OUTPUT
KAQV214S

NO.62M10005
SHEET 3 OF 7

REV.
2

● Data Curve

Load current vs. ambient temperature
Allowable ambient Temperature :
-40°C to +85°C

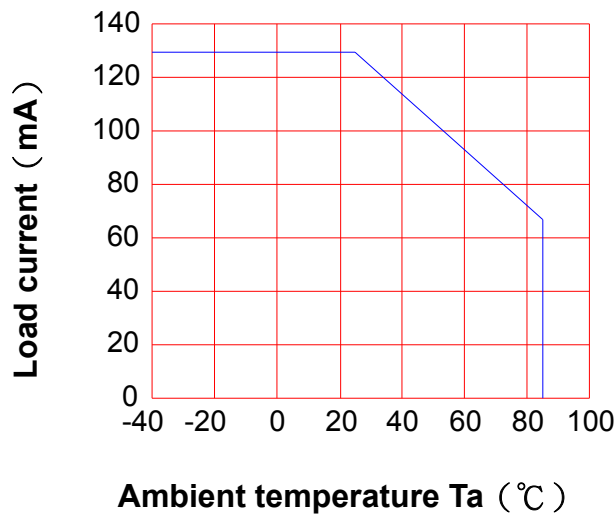

On resistance vs. ambient temperature
across terminals 4 and 6 pin
LED current : 5mA
Continuous load current : 130mA (DC)

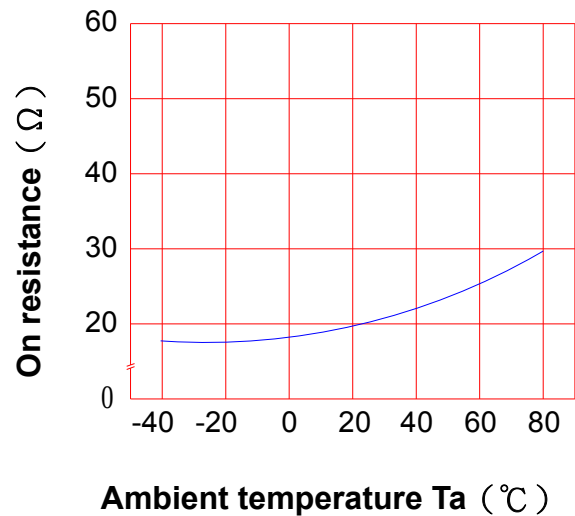

Turn On Time vs. ambient temperature
Load voltage 400V (DC)
LED current : 5mA
Continuous load current : 130mA (DC)

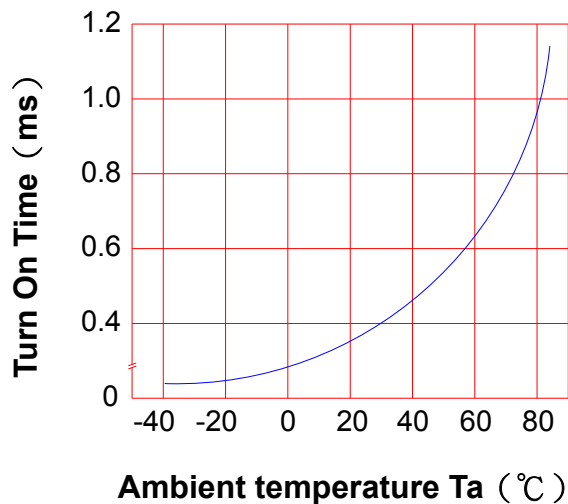

Turn Off Time vs. ambient temperature
Load voltage 400V (DC)
LED current : 5mA
Continuous load current : 130mA (DC)

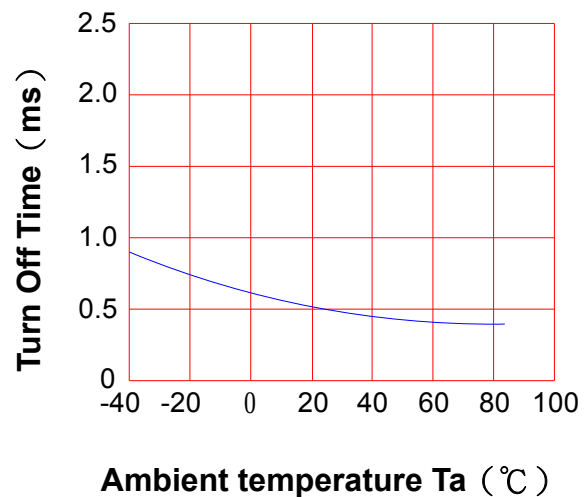

PRODUCT SPECIFICATION

DATE : 05/02/2011

cosmo
ELECTRONICS CORPORATION

SOLID STATE RELAY - MOSFET OUTPUT
KAQV214S

NO.62M10005
SHEET 4 OF 7

REV.
2

LED operate current vs.
ambient temperature

Load Voltage : 400V (DC)

Continuous load current : 130mA (DC)

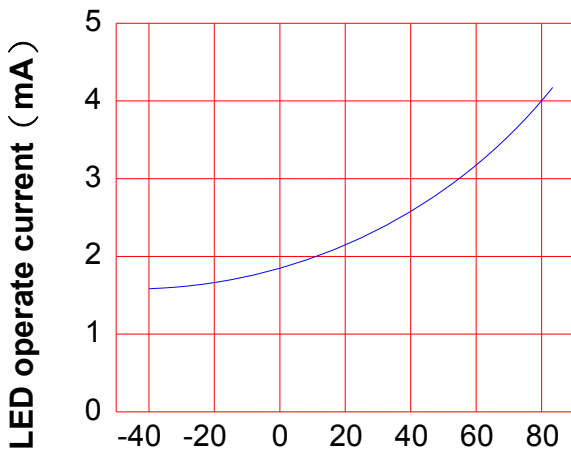

Ambient temperature Ta (°C)

LED Turn Off current vs.
ambient temperature

Load Voltage : 400V (DC)

Continuous load current : 130mA (DC)

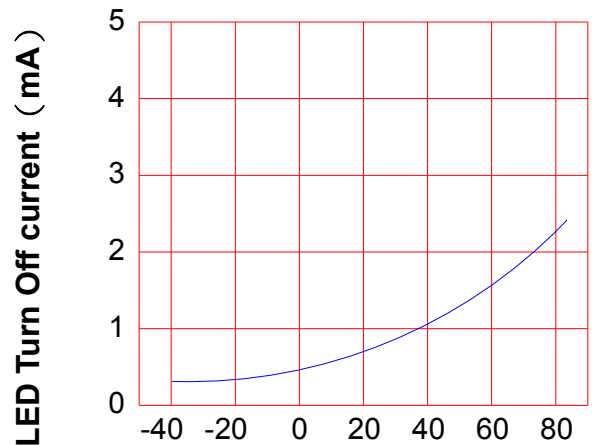

Ambient temperature Ta (°C)

LED dropout voltage vs.
ambient temperature

LED current : 5 to 50mA

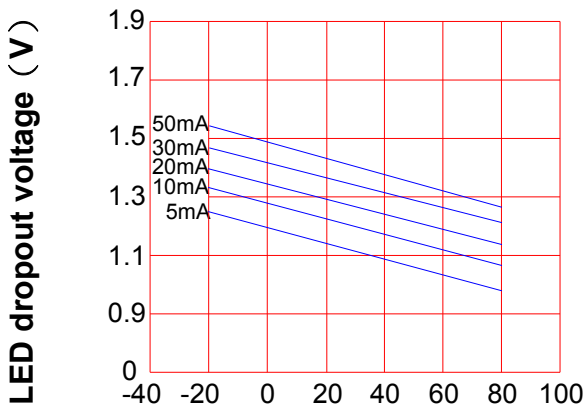

Ambient temperature Ta (°C)

Voltage vs. current characteristics
of output at MOSFET portion

Measured portion : across terminals
4 and 6 pin

Ambient temperature : 25°C

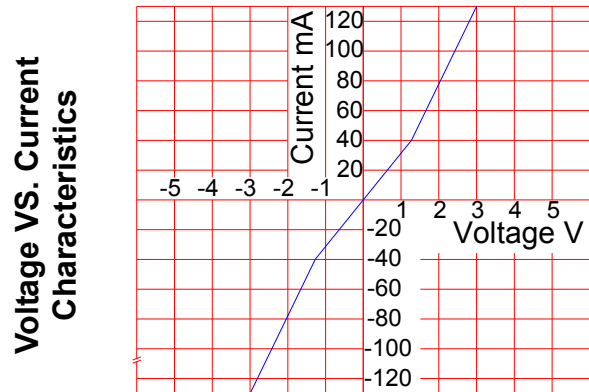

Ambient temperature : 25°C

PRODUCT SPECIFICATION

DATE : 05/02/2011

cosmo
ELECTRONICS CORPORATION

SOLID STATE RELAY - MOSFET OUTPUT
KAQV214S

NO.62M10005
SHEET 5 OF 7

REV.
2

LED forward current vs. Turn On Time

Across terminals 4 and 6pin

Load voltage : 400V (DC)

Continuous load current : 130mA (DC)

Ambient temperature : 25°C

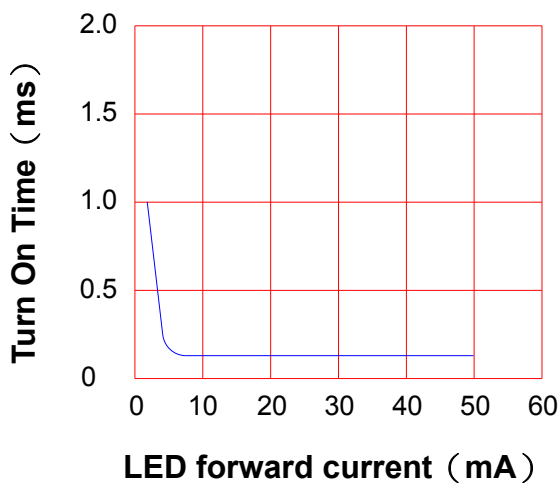

Off state leakage current

Across terminals 4 and 6 pin

Ambient temperature : 25°C

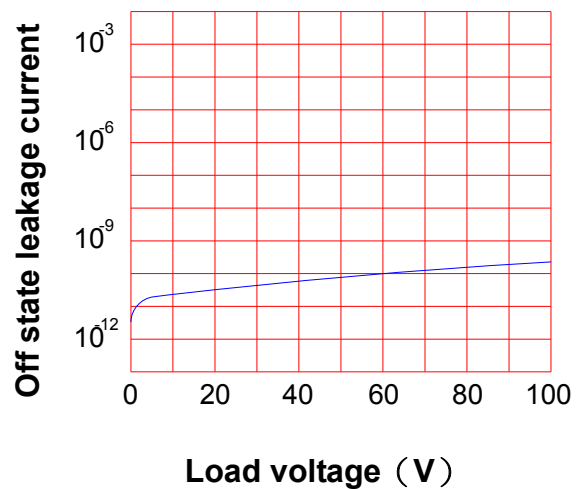

LED forward current vs. reverse(ON) time

Across terminals 4 and 6 pin

Load voltage : 400V (DC)

Continuous load current : 130mA (DC)

Ambient temperature : 25°C

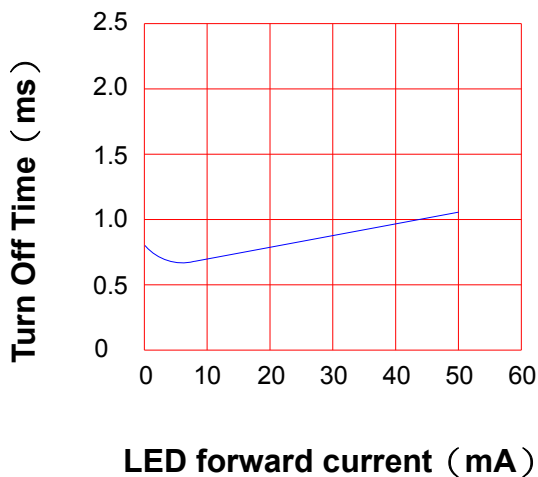

Applied voltage vs. output capacitance

Across terminals 4 and 6 pin

Frequency : 1MHz

Ambient temperature : 25°C

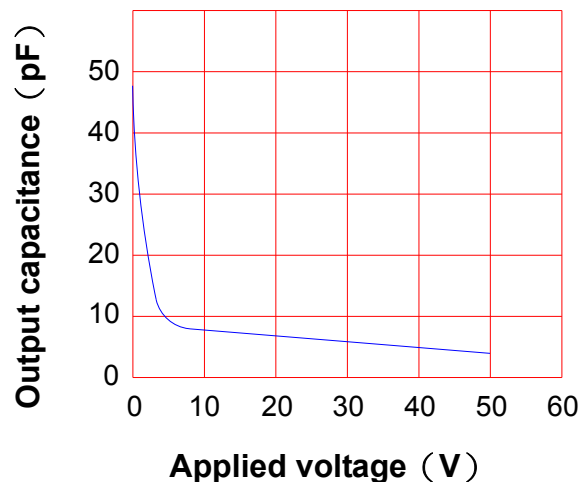

PRODUCT SPECIFICATION

DATE : 05/02/2011

cosmo
ELECTRONICS CORPORATION

SOLID STATE RELAY - MOSFET OUTPUT
KAQV214S

NO.62M10005
SHEET 6 OF 7

REV.
2

● USING METHODS

Examples of resistance value to control LED forward current (I_F)

SSR-MOSFET OUTPUT

($I_F=5\text{mA}$)

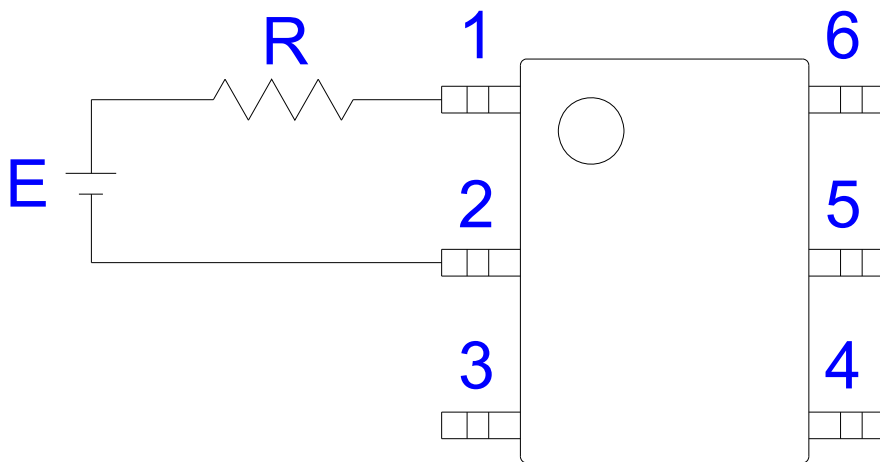

| E | R |
|------|-----------------------|
| 3.3V | Approx. 330 Ω |
| 5V | Approx. 640 Ω |
| 12V | Approx. 1.9K Ω |
| 15V | Approx. 2.5K Ω |
| 24V | Approx. 4.1K Ω |

- (1) LED forward current must be more than 5mA , at E min.
- (2) LED forward current must be less than 50mA , at E max.

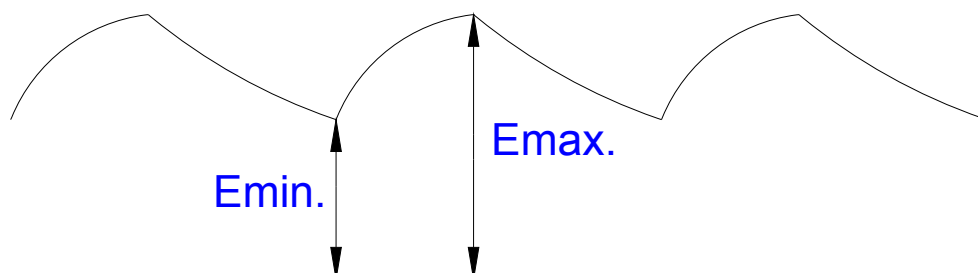

PRODUCT SPECIFICATION

DATE : 05/02/2011

cosmo
ELECTRONICS CORPORATION

SOLID STATE RELAY - MOSFET OUTPUT
KAQV214S

NO.62M10005
SHEET 7 OF 7

REV.
2

● USING METHODS

Regulate the spike voltage generated on the inductive load as follows :

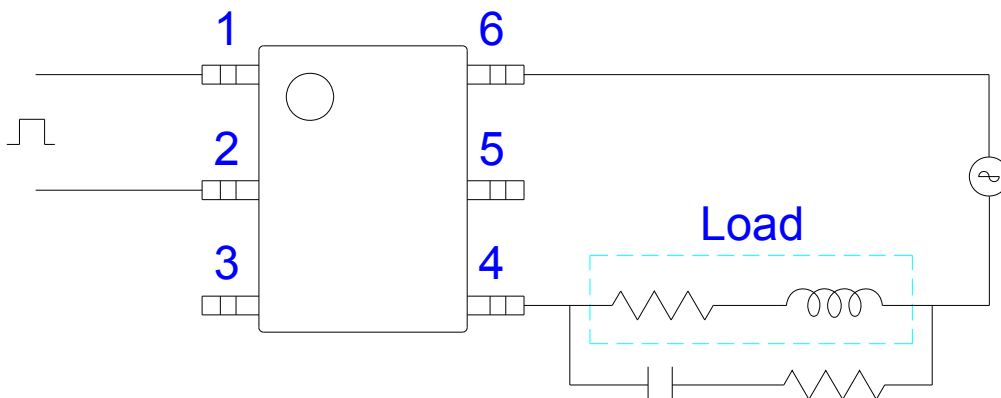
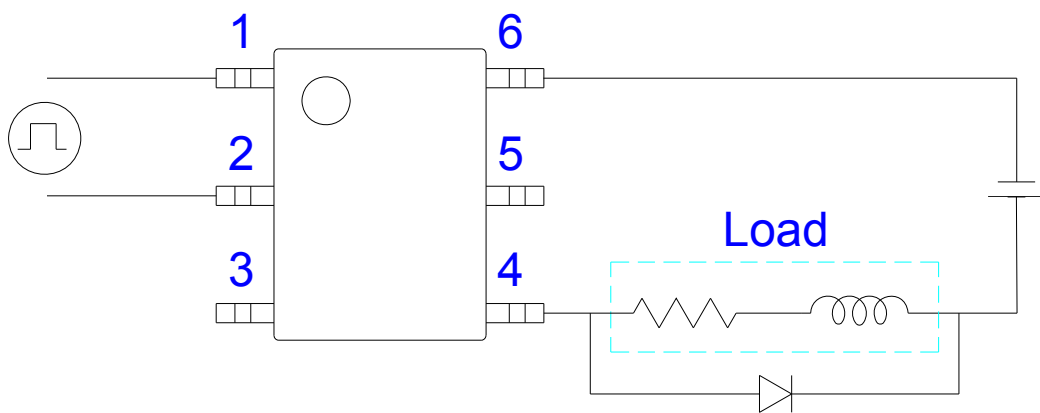

R-C Snubber