

### For 115/240 Vac (rms) Application:

1. Solenoid/Valve Controls
2. Lighting Controls
3. Static Power Switches
4. Ac Motor Drives
5. Temperature Controls
6. E.M. Contactors
7. Ac Motor Starters
8. Solid State Relays
9. Available package : DIP/ SMD/ H.  
(For Package Dimension please refer to page 82 )

### Outside Dimension : Unit (mm)

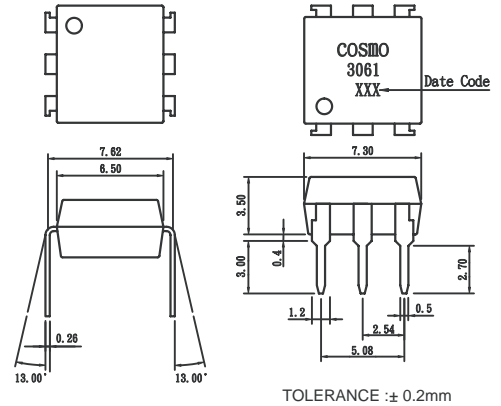

### Schematic : Top View

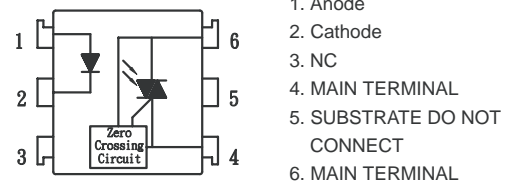

### Absolute Maximum Ratings

(Ta=25°C)

Parameter		Symbol	Rating	Unit
Input	Forward current	IF	50	mA
	Peak forward current	IFM	1	A
	Reverse voltage	VR	6	V
	Power dissipation	PD	70	mW
Output	Off-State Output Terminal voltage	VDRM	600	Vpeak
	Peak Repetitive Surget Current	ITSM	1	A
	Power dissipation	PD	300	mW
Total power dissipation		Ptot	330	mW
Isolation voltage 1 minute		Viso	5000	Vrms
Operating temperature		Topr	-40 to +80	°C
Storage temperature		Tstg	-40 to +125	°C
Soldering temperature 10 seconds		Tsol	260	°C

### Electro-optical Characteristics

(Ta=25°C)

Parameter		Symbol	Conditions	MIN.	TYP.	MAX.	Unit
Input	Forward voltage	VF	IF =10mA	—	1.2	1.5	V
	Reverse Leakage Current	IR	VR =4V	—	—	10	UA
Output	Peak Blocking Current	IDRM	VDRM =Rated	—	60	500	nA
	ON-State Voltage	VTM	ITM =100mA	—	1.8	3	V
	Critical rate of rise of OFF-state voltage	dV/dt		600	—	—	V/uS
Transfer characteristics	Holding Current	IH		—	100	—	uA
	Inhibit Voltage (MT1-MT2 Voltage above which device not trigger.)	VINH	IF =15mA	—	5	20	V
	Leakage in Inhibited State	IDRM2	IF =Rated IFT, Rated VDRM, Off State	—	—	500	uA
	Isolation resistance	Riso	DC500V	5x10 <sup>10</sup>	10 <sup>11</sup>	—	ohm
	Minimum trigger current	IFT	Main Terminal Voltage=3V	—	—	15	mA

Fig.1 On-State Characteristics

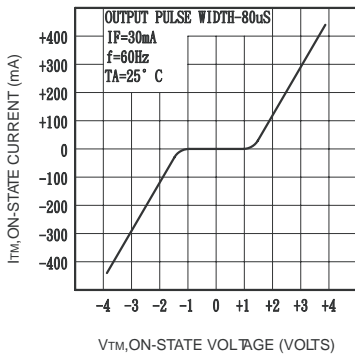

Fig.2 Inhibit Voltage versus Temperature

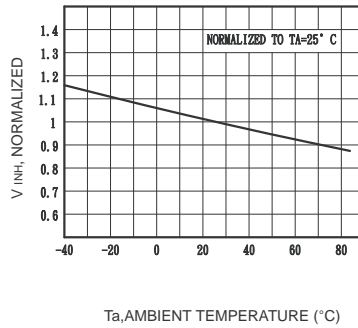

Fig.3 Leakage with LED Off versus Temperature

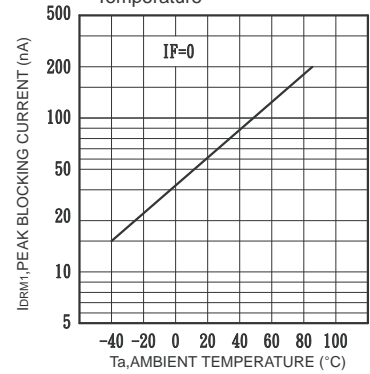

Fig.4 I<sub>DRM2</sub> Leakage in Inhibit State versus Temperature

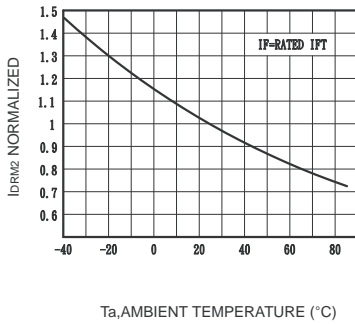

Fig.5 Trigger Current versus Temperature

