

PRODUCT SPECIFICATION

DATE:07/22/2008

cosmo ELECTRONICS CORPORATION	Photocoupler : KPC452	NO.61P04053	REV.
		SHEET 1 OF 6	2

Compact Surface Mount,High Collector emitter Voltage Type Photocoupler

● Features

1. Mini-flat package.
2. High collector-emitter voltage
($V_{CEO} : 300V$)
3. High current transfer ratio
($CTR : \text{MIN.}1000\%$ at $I_F = 1mA, V_{CE} = 2V$)
4. High isolation voltage between input and output ($V_{iso}:3750V_{rms}$).

●Applications

1. Telephone sets.
2. Copiers, facsimiles.
3. Interfaces with various power supply circuits,
power distribution boards.
4. Hybrid substrates which require high density mounting.

PRODUCT SPECIFICATION

DATE: 07/22/2008

cosmo ELECTRONICS CORPORATION	Photocoupler : KPC452	NO.61P04053	REV. 2
		SHEET 2 OF 6	

1. OUTSIDE DIMENSION : UNIT (mm)

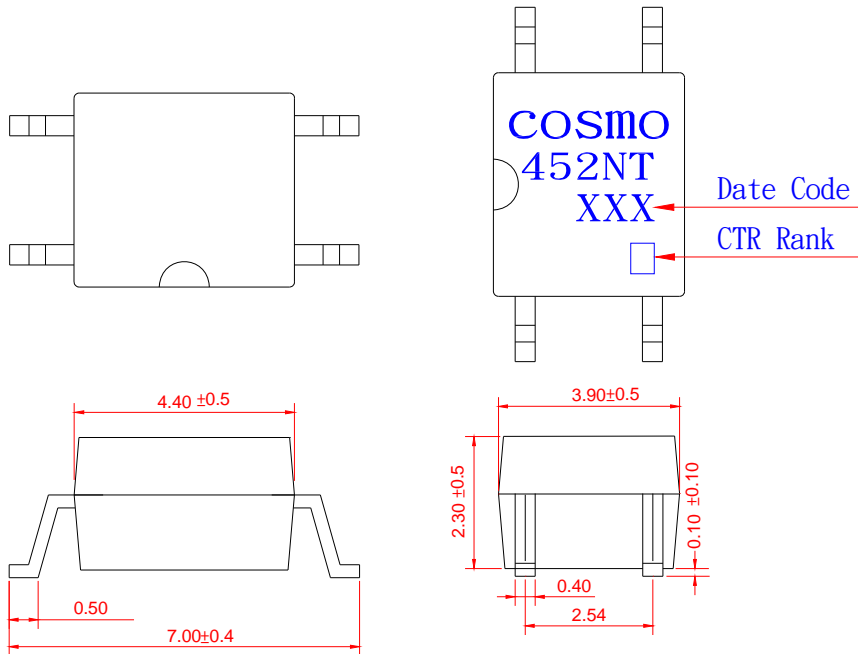

TOLERANCE : ± 0.2 mm

2. SCHEMATIC : TOP VIEW

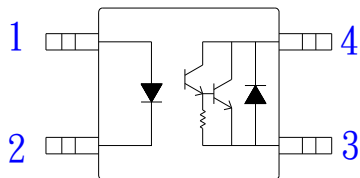

1. Anode
2. Cathode
3. Emitter
4. Collector

PRODUCT SPECIFICATION

DATE: 07/22/2008

cosmo ELECTRONICS CORPORATION	Photocoupler : KPC452	NO.61P04053	REV. 2
		SHEET 3 OF 6	

●Absolute Maximum Ratings

	Parameter	Symbol	Rating	Unit
Input	Forward current	I_F	50	mA
	Peak forward current	I_{FM}	1	A
	Reverse voltage	V_R	6	V
	Power dissipation	P	70	mW
Output	Collector-emitter voltage	V_{CEO}	300	V
	Emitter-collector voltage	V_{ECO}	0.1	V
	Collector current	I_c	150	mA
	Collector power dissipation	P_c	150	mW
	Total power dissipation	P_{tot}	170	mW
	Isolation voltage 1 minute	V_{iso}	3750	V_{rms}
	Operating temperature	T_{opr}	-55 to +115	°C
	Storage temperature	T_{stg}	-55 to +125	°C
	Soldering temperature 10 second	T_{sol}	260	°C

●Electro-optical Characteristics

	Parameter	Symbol	Conditions	MIN.	TYP.	MAX.	Unit
Input	Forward voltage	V_F	$I_F=20mA$	-	1.2	1.4	V
	Reverse current	I_R	$V_R=4V$	-	-	10	uA
	Terminal capacitance	C_t	$V=0, f=1kHz$	-	30	-	pF
Output	Collector dark current	I_{CEO}	$V_{CE}=200V, I_F=0$	-	-	1	uA
	Collector-emitter breakdown voltage	BV_{CEO}	$I_c=0.1mA, I_F=0$	300	-	-	V
Transfer characteristics	Current transfer ratio	CTR	$I_F=1mA, V_{CE}=2V$	1000	-	-	%
	Collector-emitter saturation voltage	$V_{CE(sat)}$	$I_F=20mA, I_c=100mA$	-	-	1.5	V
	Isolation resistance	Riso	DC500V, 40 to 60%RH	5×10^{10}	10^{11}	-	ohm
	Floating capacitance	C_f	$V=0, f=1MHz$	-	0.6	1.0	pF
	Response time (Rise)	t_r	$V_{ce}=2V, I_c=20mA, R_L=100ohm$	-	100	300	us
Response time (Fall)	t_f	-		20	100	us	

PRODUCT SPECIFICATION

DATE: 07/22/2008

cosmo ELECTRONICS CORPORATION	Photocoupler :	NO.61P04053	REV. 2
	KPC452	SHEET 4 OF 6	

Fig.1 Forward Current vs. Ambient Temperature

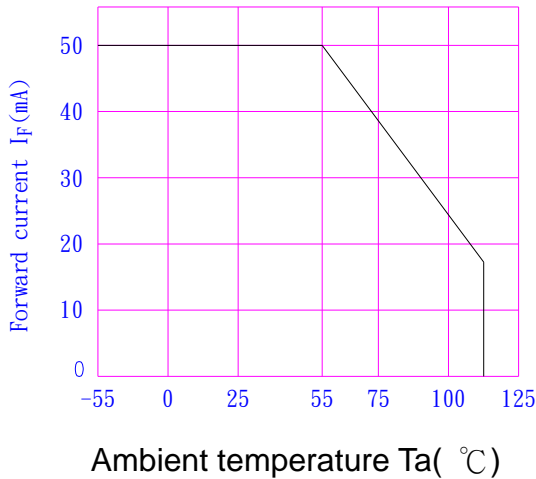

Fig.2 Collector Power Dissipation vs. Ambient Temperature

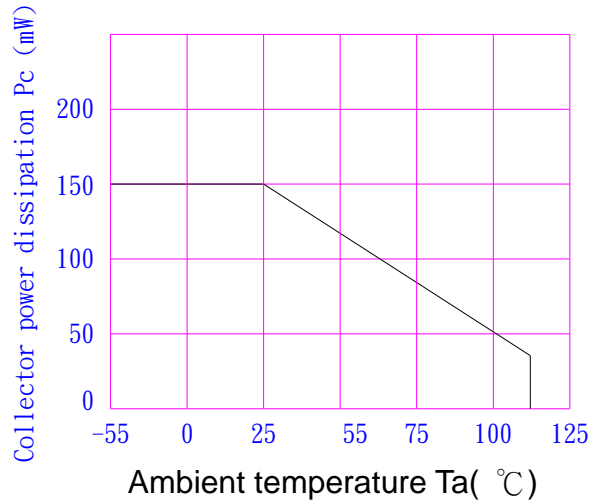

Fig.3 Peak Forward Current vs. Duty Ratio

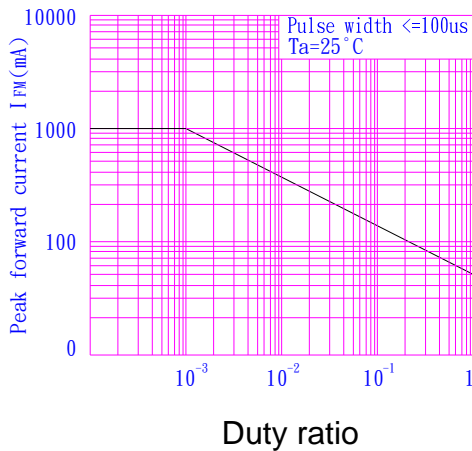

Fig.4 Forward Current vs. Forward Voltage

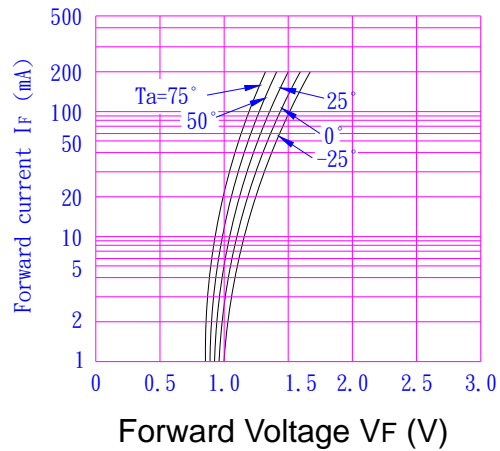

Fig.5 Current Transfer Ratio vs. Forward Current

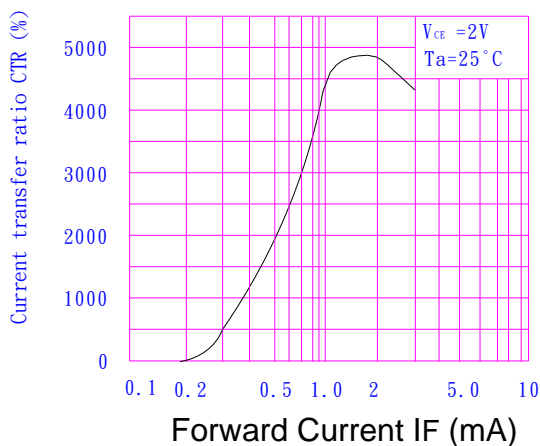
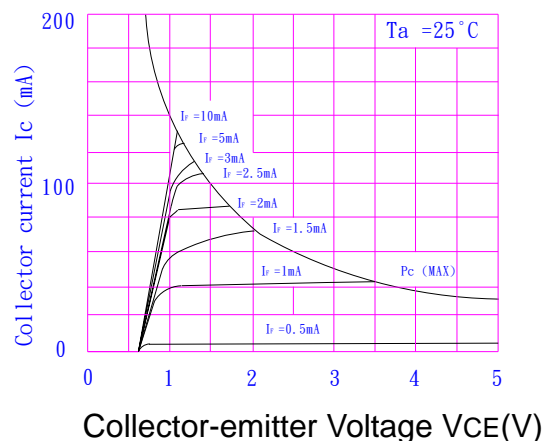

Fig.6 Collector Current vs. Collector-emitter Voltage



PRODUCT SPECIFICATION

DATE: 07/22/2008

cosmo ELECTRONICS CORPORATION	Photocoupler :	NO.61P04053	REV. 2
	KPC452	SHEET 5 OF 6	

Fig.7 Relative Current Transfer Ratio vs. Ambient Temperature

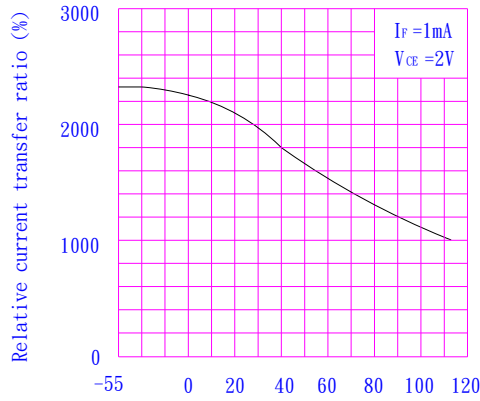

Ambient temperature Ta(°C)

Fig.8 Collector-emitter Saturation Voltage vs. Ambient Temperature

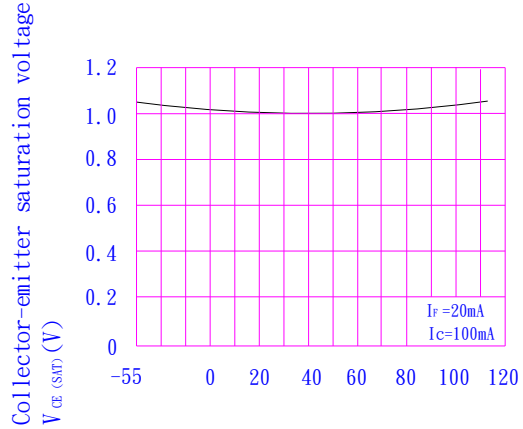

Ambient temperature Ta(°C)

Fig.9 Collector Dark Current vs. Ambient Temperature

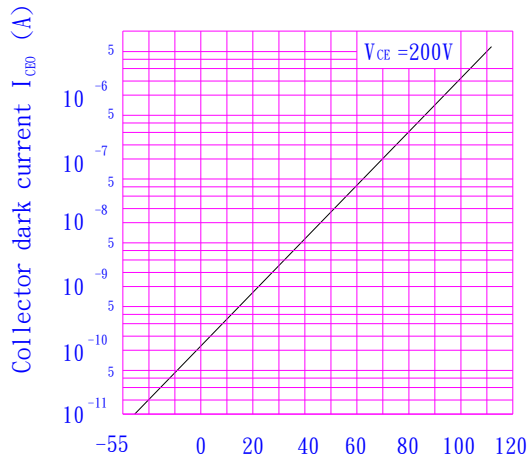

Ambient temperature Ta(°C)

Fig.10 Response Time vs. Load Resistance

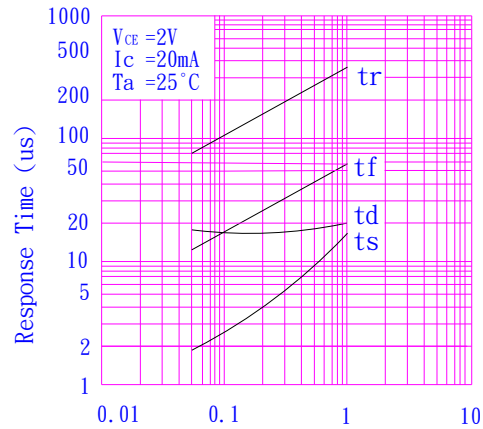

Load resistance RL (K ohm)

Fig.11 Frequency Response.

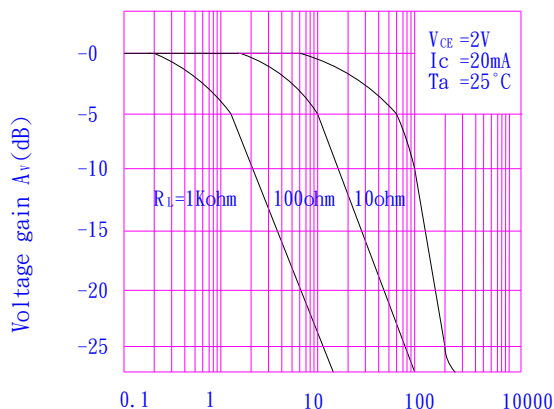

Frequency f(KHz)

Fig.12 Collector-emitter Saturation Voltage vs. Forward current

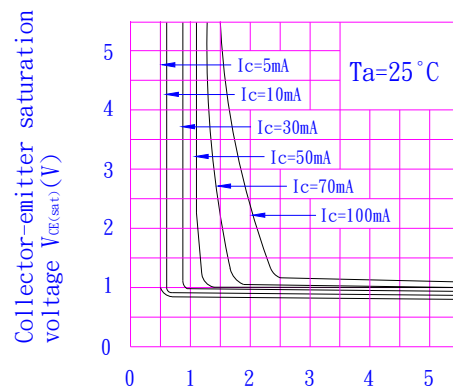

Ambient temperature Ta(°C)

PRODUCT SPECIFICATION

DATE: 07/22/2008

cosmo ELECTRONICS CORPORATION	Photocoupler : KPC452	NO.61P04053	REV.
		SHEET 6 OF 6	2

NOTICE

The information contained in this document is a general product description and is subject to change without notice. Please contact cosmo in order to obtain the latest device data sheets before using any cosmo device. cosmo does not assume any responsibility for use of any circuitry described. No circuit patent licenses are implied. This publication is the property of cosmo. No part of this publication may be reproduced or copied in any form or by any means, or transferred to any third party without the prior written consent of cosmo Electronics Corporation.

The devices listed in this document are designed for general applications only in electronic equipment. No devices shall be deployed which require higher level of reliability such as:

- Medical and other life support equipments.
- Space application.
- Telecommunication equipment (trunk lines).
- Nuclear power control equipment.

Unless it received prior written approval from cosmo.

cosmo takes no responsibility for damages arise form the improper usage of our device. Please contact cosmo for further information regarding the above notices.