

Features

1. High current transfer ratio
(CTR:MIN.600% at IF=1mA, Vce=2V)
2. High isolation voltage between input and output
(Viso:5000Vrms).
3. Compact dual-in-line package.

Applications

1. System appliances, measuring instruments.
2. Industrial robots.
3. Copiers, automatic vending machines.
4. Signal transmission between circuits of different potentials and impedances.

Outside Dimension:Unit (mm)

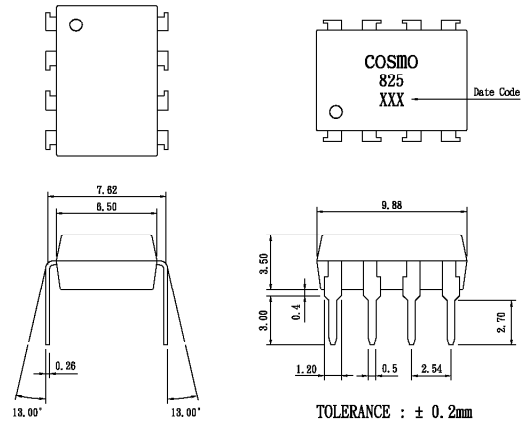

Schematic:Top View

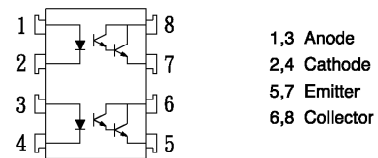

Absolute Maximum Ratings

(Ta=25°C)

Parameter	Symbol	Rating	Unit
Input	Forward current	IF	50 mA
	Peak forward current	IFM	1 A
	Reverse voltage	VR	6 V
	Power dissipation	Pd	70 mW
Output	Collector-emitter voltage	VCEO	35 V
	Emitter-collector voltage	VECO	6 V
	Collector current	IC	80 mA
	Collector power dissipation	PC	150 mW
Total power dissipation	Ptot	200 mW	
Isolation voltage 1 minute	Viso	5000	Vrms
Operating temperature	Topr	-30 to +100	°C
Storage temperature	Tstg	-55 to +125	°C
Soldering temperature 10 second	Tsol	260	°C

Electro-optical Characteristics

(Ta=25°C)

Parameter	Symbol	Conditions	MIN.	TYP.	MAX.	Unit	
Input	Forward voltage	VF	—	1.2	1.4	V	
	Peak forward voltage	VFM	—	—	3.0	V	
	Reverse current	IR	VR=4V	—	—	10 μA	
	Terminal capacitance	Ct	V=0, f=1kHz	—	30	250 pF	
Output	Collector dark current	ICEO	—	—	1.0	μA	
Transfer characteristics	Current transfer ratio	CTR	IF=1mA, VCE=2V	600	—	7500	%
	Collector-emitter saturation voltage	VCE(sat)	IF=20mA, IC=5mA	—	0.8	1.0	V
	Isolation resistance	Riso	DC500V, 40 to 60% RH	5X10 ¹⁰	—	—	ohm
	Floating capacitance	Cf	V=0, f=1MHZ	—	0.6	1.0	pF
	Cut-off frequency	fc	Vcc=2V, IC=20mA, RL=100ohm	1	6	—	kHz
	Response time (Rise)	tr	VCE=2V, IC=20mA, RL=100ohm	—	80	300	μs
Response time (Fall)	tf	—		72	250	μs	

Fig.1 Forward Current vs. Ambient Temperature

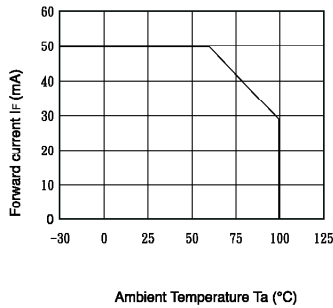

Fig.2 Collector Power Dissipation vs. Ambient Temperature

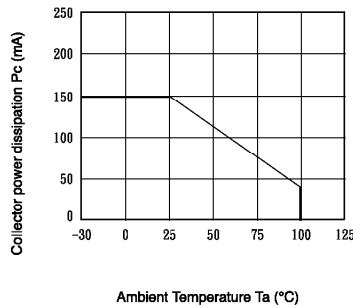

Fig.3 Collector-emitter Saturation Voltage vs. Forward Current

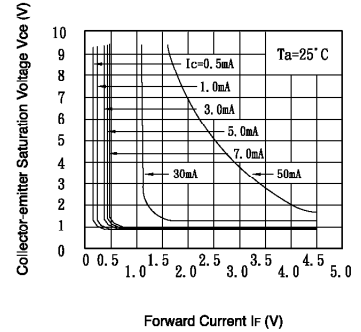

Fig.4 Forward Current vs. Forward Voltage

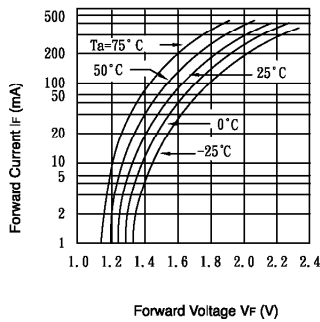

Fig.5 Collector Transfer Ratio vs. Forward Current

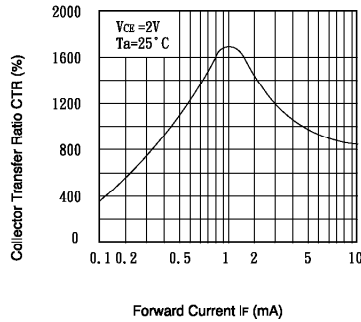

Fig.6 Collector Current vs. Collector-emitter Voltage

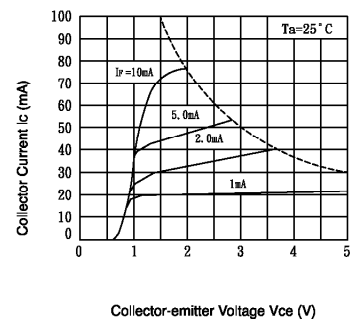

Fig.7 Relative Transfer Ratio vs. Ambient Temperature

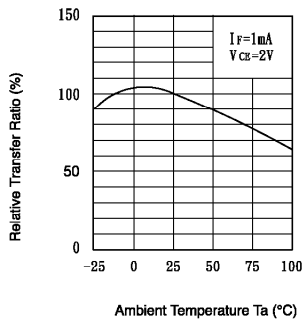

Fig.8 Collector-emitter Saturation Voltage vs. Ambient Temperature

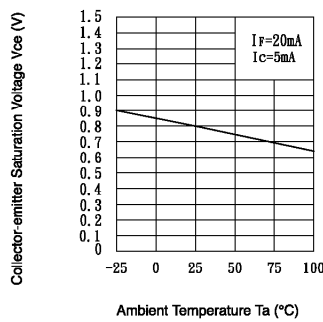

Fig.9 Collector Dark Current vs. Ambient Temperature

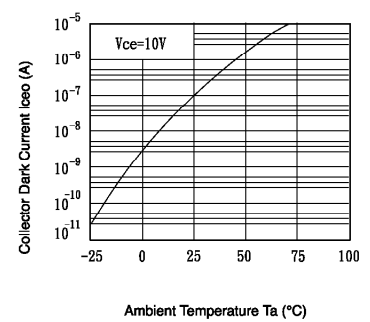

Fig.10 Response Time vs. Load Resistance

