

Features

1. High current transfer ratio (V_{CEO}:300V MIN)
(CTR:MIN.600% at I_F=1mA, V_{ce}=2V)
2. High isolation voltage between input and output
(Viso:5000Vrms).
3. Compact dual-in-line package.
4. Available package : DIP/ SMD/ H. (For Package Dimension please refer to page 82)

Applications

1. System appliances, measuring instruments.
2. Industrial robots.
3. Copiers, automatic vending machines.
4. Signal transmission between circuits of different potentials and impedances.
5. Telephone sets.
6. Copiers, facsimiles.
7. Interface with various power supply circuits, power distribution boards.
8. Numerical control machines.

Outside Dimension : Unit (mm)

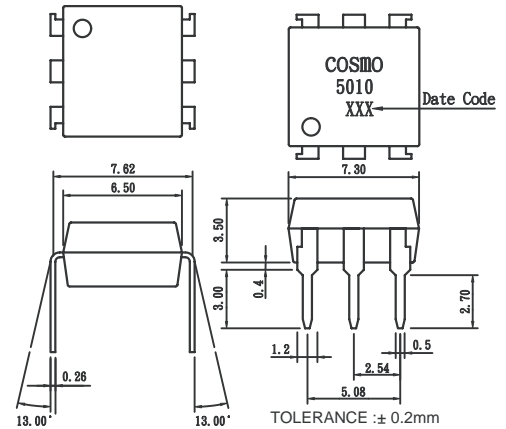

Schematic : Top View

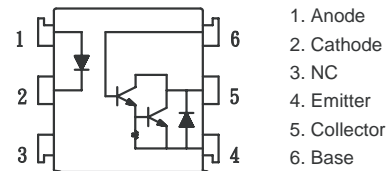

Absolute Maximum Ratings

(Ta=25°C)

Parameter	Symbol	Rating	Unit
Input	Forward current	I _F	50 mA
	Peak forward current	I _{FM}	1 A
	Reverse voltage	V _R	6 V
	Power dissipation	P _D	70 mW
Output	Collector-emitter voltage	V _{CEO}	300 V
	Collector-base voltage	V _{CBO}	300 V
	Emitter-base voltage	V _{EBO}	6 V
	Collector current	I _c	150 mA
	Collector power dissipation	P _c	200 mW
Total power dissipation	P _{tot}	200 mW	
Isolation voltage 1 minute	V _{iso}	5000	V _{rms}
Operating temperature	T _{opr}	-30 to +100	°C
Storage temperature	T _{stg}	-55 to +125	°C
Soldering temperature 10 second	T _{sol}	260	°C

Electro-optical Characteristics

(Ta=25°C)

Parameter	Symbol	Conditions	MIN.	TYP.	MAX.	Unit
Input	Forward voltage	I _F = 20mA	—	1.2	1.4	V
	Peak forward voltage	I _{FM} = 0.5A	—	—	3.5	V
	Reverse current	V _R = 4V	—	—	10	uA
	Terminal capacitance	V=0, f=1kHz	—	30	—	pF
Output	Collector dark current	V _{CE} = 200V, I _F = 0	—	—	1	uA
Transfer characteristics	Current transfer ratio	I _F = 1mA, V _{CE} = 2V	600	—	9000	%
	Collector-emitter saturation voltage	I _F = 20mA, I _c = 5mA	—	—	1.5	V
	Isolation resistance	DC500V	5X10 ¹⁰	—	—	ohm
	Floating capacitance	V=0, f=1MHz	—	0.6	1.0	pF
	Cut-off frequency	V _{CC} = 5V, I _c = 2mA, R _L = 100ohm	—	7	—	kHz
	Response time (Rise)	V _{CE} = 2V, I _c = 20mA, R _L = 100ohm	—	60	300	us
	Response time (Fall)		—	50	250	us

Classification table of current transfer ratio is shown below.

Model NO.	CTR (%)
*KP5010 A	600 TO 2000
KP5010 B	1500 TO 4000
KP5010 C	3000 TO 6000
*KP5010 D	5000 TO 9000
KP5010 E	600 TO 9000

*SPECIAL OPTION

Fig.1 Current Transfer Ratio vs. Forward Current

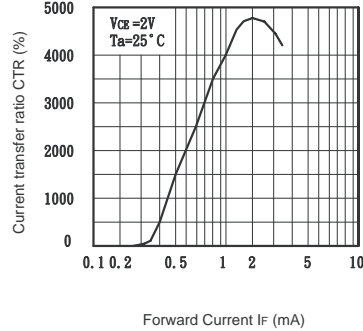

Fig.2 Collector Power Dissipation vs. Ambient Temperature

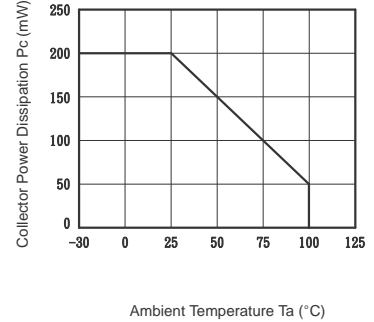

Fig.3 Collector Dark Current vs. Ambient Temperature

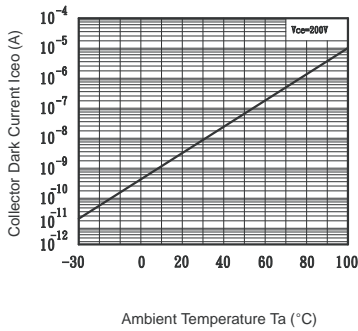

Fig.4 Forward Current vs. Ambient Temperature

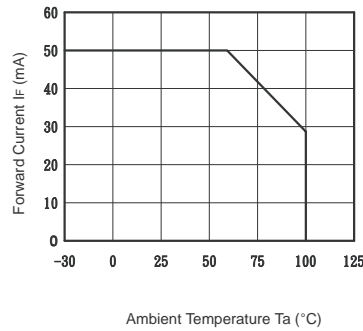

Fig.5 Forward Current vs. Forward Voltage

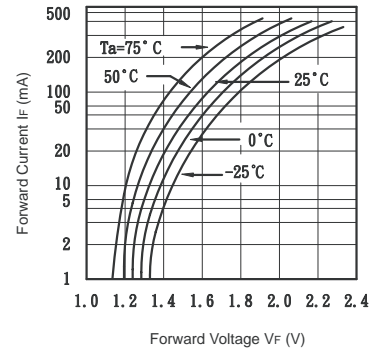

Fig.6 Collector Current vs. Collector-emitter Voltage

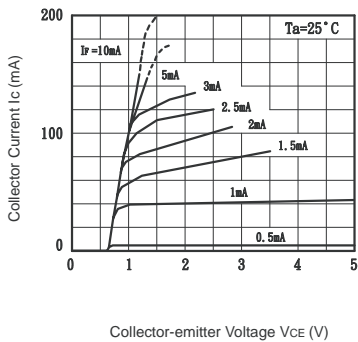

Fig.7 Relative Current Transfer Ratio vs. Ambient Temperature

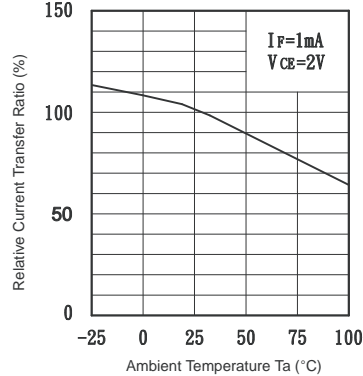

Fig.8 Collector-emitter Saturation Voltage vs. Forward Current

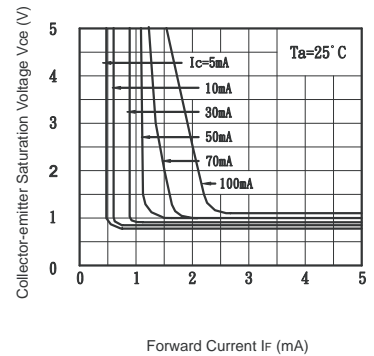

Fig.9 Response Time vs. Load Resistance

