



EGA10603V24B0

Specification

Product Name	ESD Guard™
Series	EGA Series
Part No	EGA10603V24B0
Size	EIA 0603



EGA10603V24B0 Engineering Specification

1. Scope

This specification is applied to electrostatic discharge (ESD) protection. It is designed to protect the high-speed data lines against ESD transients. It has very low capacitance and fast turn on times makes it ideal for data and transmission lines with high data rates.

According to the special property of device, It can be used in power line in certain conditions but we recommend not to use on such application as

: DC/AC power line, keypad, and button circuit

For RoHS Compliance.

Feature

- Protection against ESD voltages and currents (IEC61000-4-2 Level 4)
- Extremely quick response time (<1ns) present ideal ESD protection
- Extremely low capacitance (0.25pF typical)
- Extremely low leakage current
- Bi-directional device
- SMD (Surface Mount Device)

Applications

EGA10603V24B0 is applied to high speed signal interface.

- USB 3.0
- HDMI
- Displayport
- MIPI
- LVDS
- MDDI
- DVI
- RGB

Product Model

- Digital Video Equipment
- Mobile Phone
- GPS Antenna
- Bluetooth Communication Equipment

2. Explanation of Part Number

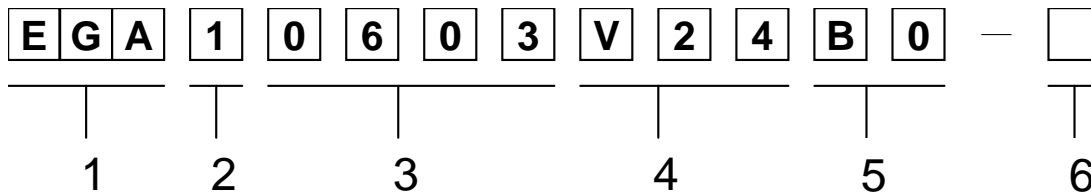

- ◆ 1 : ESDGUARD Series
- ◆ 2 : Single element
- ◆ 3 : Chip size, EIA 0603
- ◆ 4 : Max rated voltage, VDC
- ◆ 5 : "B0" : Model Code (B: Pb free type)
- ◆ 6 : Suffix for Special Code

3. Circuit symbol



4. Construction & Dimensions

4.1. End termination: Ag/Ni/Sn

4.2. Construction & Dimension :

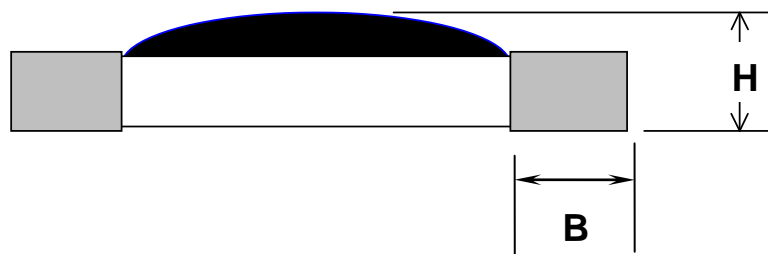
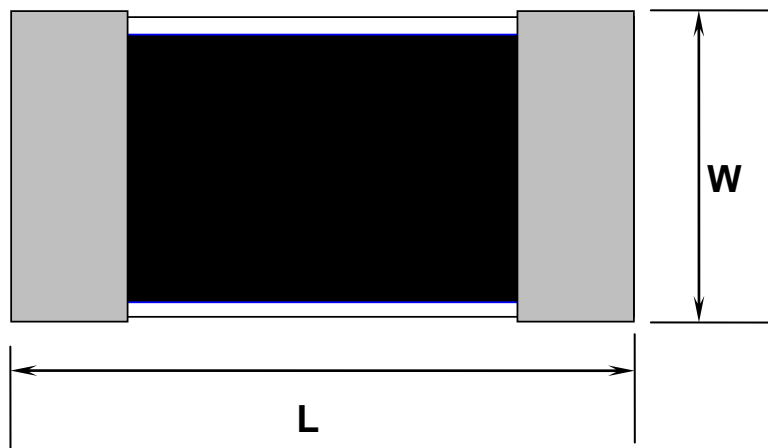

Unit: mm

L	W	H	B
1.60±0.10	0.85±0.15	0.51±0.05	0.30±0.20

5. Performance Characteristics

Characteristic	Value
Rated voltage (max)	24 V
Leakage current (max) (@12VDC)	0.01 μ A
Peak voltage (Vp)	300V typical
Trigger voltage (Vt)	300V typical
Clamping voltage (Vc)	30V typical
Capacitance (Cp), @1MHz	0.2pF typical
Response time	<1ns
ESD voltage capability, IEC 61000-4-2 Contact discharge mode	8KV
ESD voltage capability, IEC 61000-4-2 Air discharge mode	15KV
ESD withstand pulses	1000 typical

Vp –The peak voltage value shall be measured under the following conditions. ESD test conditions : IEC61000-4-2, 8 kV contact discharge

Vt – measurement by using Transmission Line Pulse (TLP)

Vc –measurement by using Transmission Line Pulse (TLP)

Cp – Device capacitance measured with 1Vrms

6. General specifications

6.1. Temperature Specifications

Operating Temperature range : -55°C to + 125°C
Storage Temperature range : -55°C to + 125°C

6.2. Temperature Specifications

Item	Specifications	Test condition	Reference
Bias humidity	$I_L \leq 10 \mu A$	85%RH, 85°C, rated voltage 12VDC, 1000 hrs	MIL-STD-202 Method 103
Thermal Shock	$I_L \leq 10 \mu A$	-40°C to 85°C, 30 min. cycle, 5 cycles	JIS C 0025 (1998)Test Na
High Temperature load voltage	$I_L \leq 10 \mu A$	Rated voltage, 85°C, 1000 hrs	MIL-STD-202G Method 108
Solder leach resistance	$I_L \leq 10 \mu A$	260°C, 10s	MIL-STD-202G Method 210F
Vibration	$I_L \leq 10 \mu A$	The entire frequency range : 10~55Hz 1.5mm amplitude 2 hours for each of X, Y, Z directions	MIL-STD-202G Method 201A

I_L – Leakage current at rated voltage, the maximum leakage current was measured after reliability test.

7. Taping Package and Label Marking

7.1. Packaging method

- 7.1.1. Products shall be heat-sealed in the chip pocket, spacing pitch 4-mm of carrier tape with cover tape, and the carrier tape shall be reeled to the reel.
- 7.1.2. Tape material to be paper. Tape thickness to be 0.6 ± 0.03 mm.
- 7.1.3. Cover tape adhesion to be 35 ± 25 grams.

7.2. Carrier tape dimensions

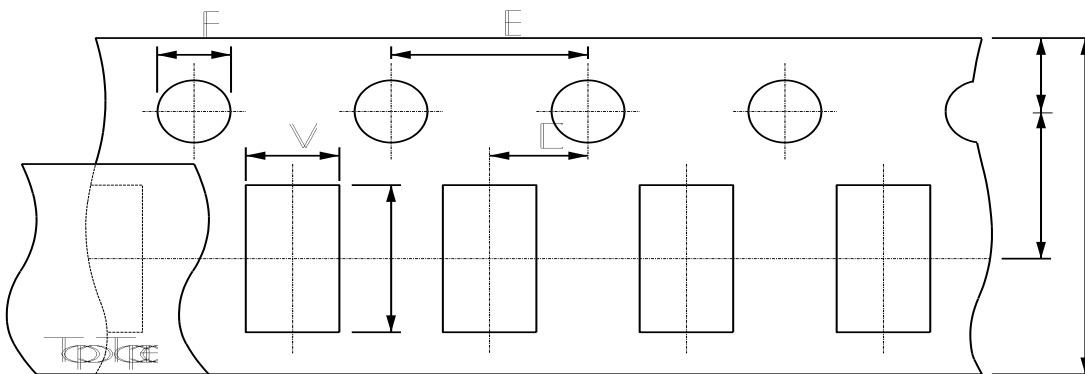

Unit: mm

	0603
A	8.00±0.30
B	3.50±0.05
C	1.75±0.10
D	2.00±0.05
E	4.00±0.10
F	1.50±0.10
L	1.90±0.20
W	1.05±0.20
T	0.60±0.03

7.3. Taping reel dimensions

Unit: mm

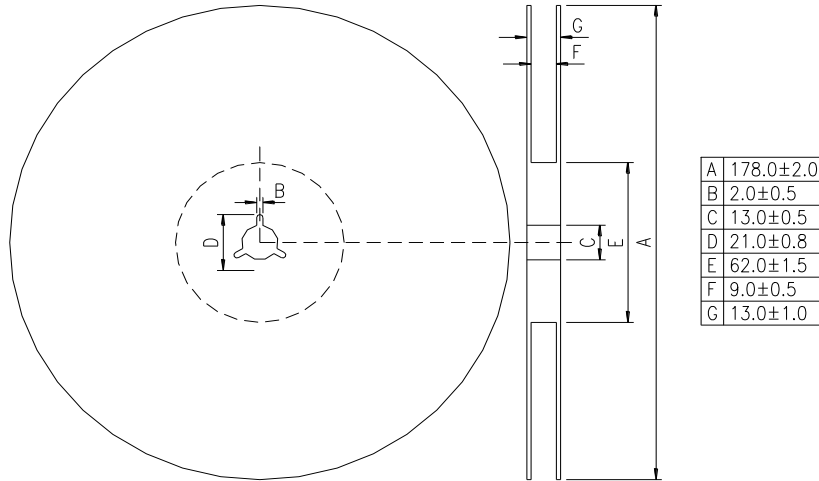

7.4. Taping specifications

There shall be the portion having no product in both the head and the end of taping, and there shall be the cover tape in the head of taping.

7.5. Label Marking

The label specified as follows shall be put on the side of reel.

- (1) Part No.
- (2) Quantity
- (3) Lot No.

* Part No. And Quantity shall be marked on outer packaging.

7.6. Quantity of products in the taping package

- (1) Standard quantity : 5000pcs/Reel
- (2) Shipping quantity is a multiple of standard quantity.

8. Precautions for Handling

8.1. Solder cream in reflow soldering

Refer to the recommendable land pattern as printing mask pattern for solder cream.
solder cream.

- (1) Print solder in a thickness of 0.15 to 0.20 mm.

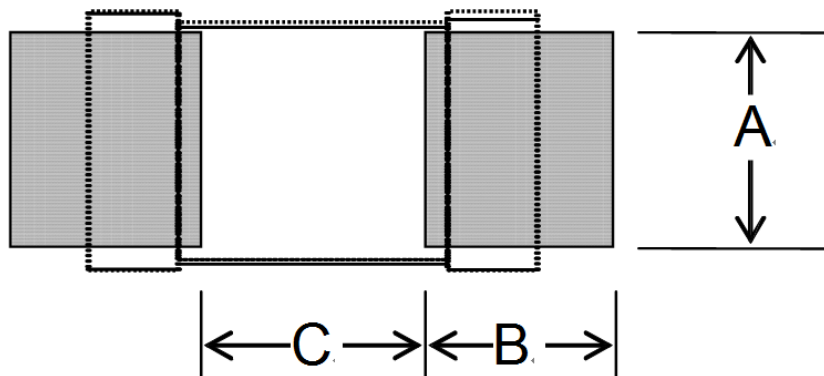

Unit : mm(inch)

A	0.75±0.1 (0.03±0.004)
B	0.75±0.1 (0.03±0.004)
C	0.75±0.1 (0.03±0.004)

8.2. Precaution for handling of substrate

Do not exceed to bend the board after soldering this product
extremely. (reference examples)

- Mounting place must be as far as possible from the position, which is close to the break line of board, or on the line of large holes of board.
- Do not bend extremely the board, in mounting another components.
If necessary, use back-up pin (support pin) to prevent from bending extremely.
- Do not break the board by hand. We recommend to use the machine or the jig to break it.

8.3. Precaution for soldering

Note that this product will be easily damaged by rapid heating, rapid cooling or local heating.

Do not give heat shock over 100°C in the process of soldering. We recommend to take preheating and gradual cooling.

8.4. Recommendable reflow soldering

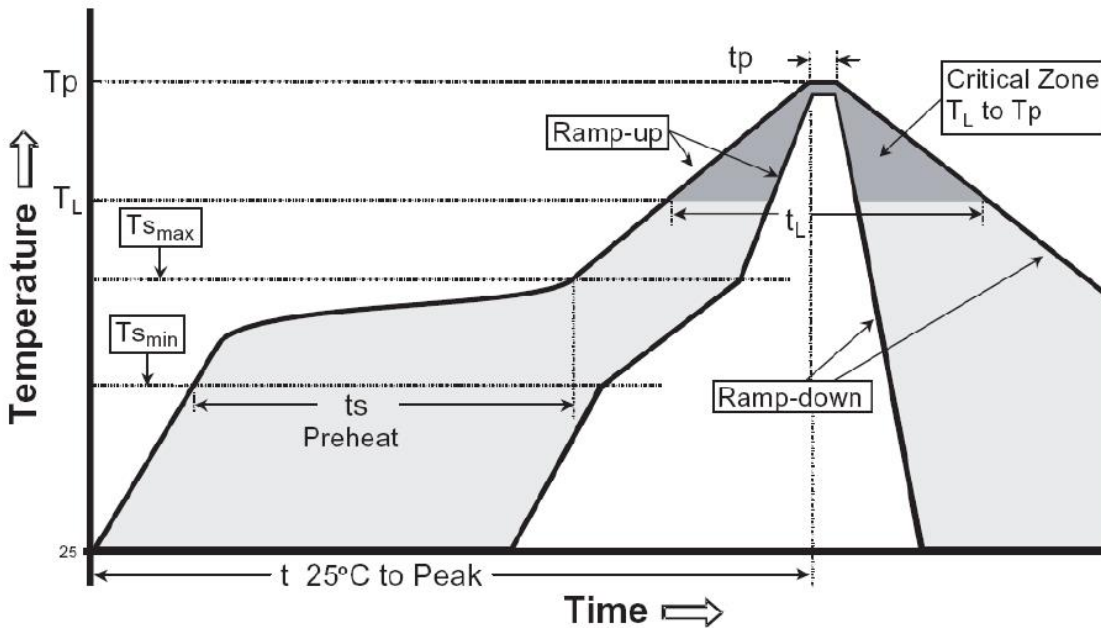

Reference IPC-J-STD-020D.1

Profile Feature	Pb free Assembly
Average Ramp Rate (Ts max to Tp)	3 °C/second max
Preheat	
- Temperature Min (Ts _{min})	150°C
- Temperature Min (Ts _{max})	200°C
- Time(ts _{min} to ts _{min})	60-120 seconds
Time maintained above:	
- Temperature (TL)	217°C
- Time (tL)	60-150 seconds
Peak Temperature (Tp)	260°C +0/-5 °C
Time within 5 °C of actual Peak Temperature (Tp)	30 seconds
Ramp-Down Rate	6 °C/second max.
Time 25°C to Peak Temperature	8 minutes max

8.5. Soldering gun procedure

Note the follows, in case of using solder gun for replacement.

- (1) The tip temperature must be less than 280°C for the period within 3 seconds by using soldering gun under 30 W.
- (2) The soldering gun tip shall not touch this product directly.

8.6. Soldering volume

Note that excess of soldering volume will easily get crack the body of this product.

8.7. Taping Package Storage Condition

Storage Temperature : 5 to 40 °C

Relative Humidity: < 65%RH

Storage Time : 12 months max