

ULTRA LOW CAPACITANCE MULTI-LINE STEERING DIODE ARRAY



SO-14 PACKAGE

DESCRIPTION

The PMMAD Series are a low distortion steering diodes. These devices are intended for use in high frequency analog or digital data I/O ports for protection against Electrostatic Discharge (ESD) and Electrical Fast Transients (EFT). The PMMAD Series is connected between rail-to-rail voltage bus or rail-to-ground for clamping and diverting overvoltage transients for the protection of sensitive network interface circuits.

This series provides low capacitance, which insures signal integrity up to 900MHz, while complete isolation between adjacent diodes keeps cross-talk to a minimum. The PMMAD Series is available in a SO-14 package and meets the IEC 61000-4-2, IEC 61000-4-4 and IEC 61000-4-5 requirements.

FEATURES

- Compatible with IEC 61000-4-2 (ESD): Air - 15kV, Contact - 8kV
- Compatible with IEC 61000-4-4 (EFT): 40A - 5/50ns
- Compatible with IEC 61000-4-5 (Surge): 24A, 8/20 μ s - Level 2(Line-Gnd) & Level 3(Line-Line)
- 500 Milliwatt Continuous Power Dissipation
- Low Insertion Loss & Cross-Talk
- ESD Protection > 25 kilovolts
- Protects 8 I/O Lines
- Working Voltage > 50 Volts
- Low Leakage Current < 0.1 μ A
- Ultra Low Capacitance: 5pF per Diode
- RoHS Compliant
- REACH Compliant

APPLICATIONS

- High Frequency Data Lines
- RS-232 & RS-422 Interface Networks
- Ethernet 10/100 Base T
- Computer I/O Ports

MECHANICAL CHARACTERISTICS

- Molded JEDEC SO-14 Package
- Approximate Weight: 0.15 grams
- Lead-Free Pure-Tin Plating (Annealed)
- Solder Reflow Temperature:
Pure-Tin - Sn, 100: 260-270°C
- 16mm Tape and Reel Per EIA Standard 481
- Flammability Rating UL 94V-0

CIRCUIT DIAGRAM

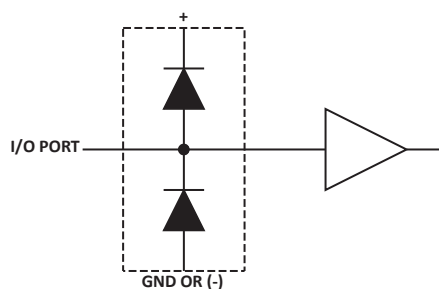

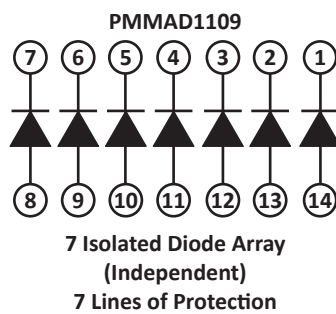
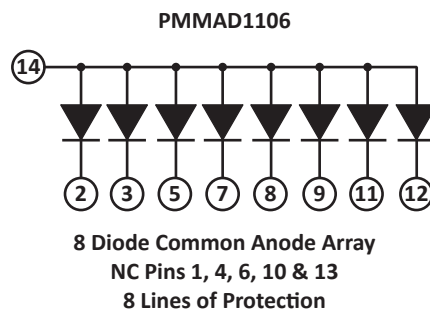
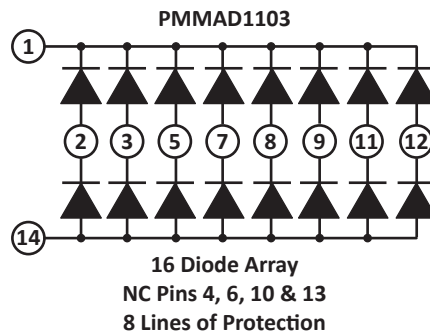
PIN IDENTIFICATION AND CONFIGURATION

TYPICAL DEVICE CHARACTERISTICS
MAXIMUM RATINGS @ 25°C Unless Otherwise Specified

PARAMETER	SYMBOL	VALUE	UNITS
Continuous Power Dissipation	P_{PK}	500	Milliwatts
Continuous Forward Current (Single Diode)	I_P	400	mA
Repetitive Peak Forward Current @ $t_p = 5\mu s$, $F = 50kHz$	I_{FRM}	700	mA
Operating Temperature	T_A	-55 to 150	°C
Storage Temperature	T_{STG}	-55 to 150	°C

ELECTRICAL CHARACTERISTICS PER LINE @ 25°C Unless Otherwise Specified

PART NUMBER	REPETITIVE PEAK REVERSE VOLTAGE @ 10 μA V_{RRM} VOLTS	MAXIMUM FORWARD PEAK PULSE CURRENT @ 8/20 μs I_{FM} AMPS	MAXIMUM FORWARD VOLTAGE @ 100mA V_F VOLTS	MAXIMUM REVERSE LEAKAGE CURRENT V_{RRM} @ 40V I_R μA	MAXIMUM CAPACITANCE (Per Diode) @4V, 1MHz C_J pF
PMMAD1103	50	40	1.2	0.1	5
PMMAD1106	50	40	1.2	0.1	5
PMMAD1109	50	40	1.2	0.1	5

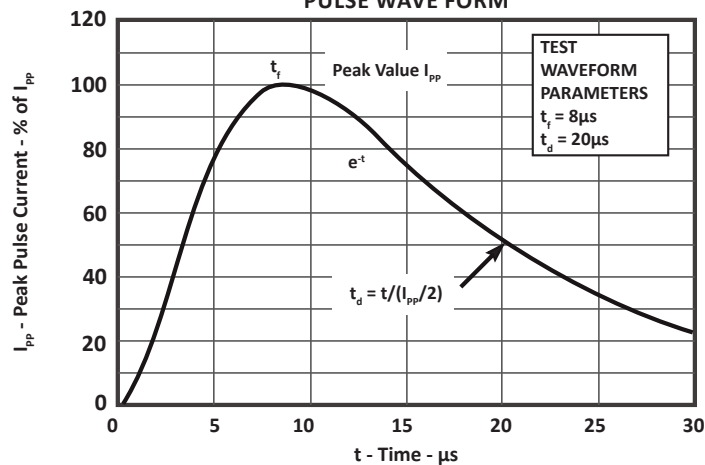
**FIGURE 1
PULSE WAVE FORM**

SPICE MODEL

FIGURE 1
SPICE MODEL

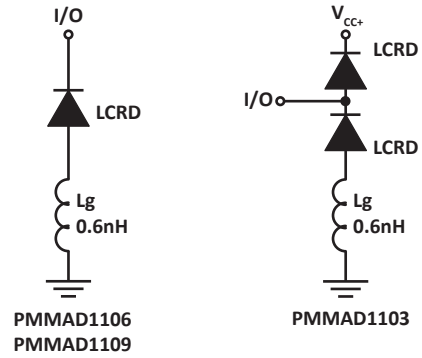

LCRD - Low Capacitance Rectifier Diode
Lg - Lead Inductance

TABLE 1 - SPICE PARAMETERS		
PARAMETER	UNIT	LCRD
BV	V	200
IBV	μA	0.01
C_{jo}	pF	3
I_s	A	1E-13
Vj	V	0.6
M	-	0.33
N	-	1
R_s	Ohms	0.31
TT	s	1E-9
EG	eV	1.11

SO-14 PACKAGE INFORMATION

OUTLINE DIMENSIONS

DIM	MILLIMETERS		INCHES	
	MIN	MAX	MIN	MAX
A	8.55	8.75	0.337	0.344
B	3.80	4.00	0.150	0.157
C	1.35	1.75	0.054	0.068
D	0.35	0.49	0.014	0.019
F	0.40	1.25	0.016	0.049
G	1.27 BSC		0.05 BSC	
J	0.18	0.25	0.007	0.009
K	0.10	0.25	0.004	0.008
P	5.80	6.20	0.229	0.244
R	0.25	0.50	0.010	0.019

NOTES

- T = Seating plane and datum surface.
- Dimensions "A" and "B" are datum.
- Dimensions "A" and "B" do not include mold protrusion.
- Maximum mold protrusion is 0.015" (0.380mm) per side.
- Dimensioning and tolerances per ANSI Y14.5M, 1982.
- Dimensions are exclusive of mold flash and metal burrs.

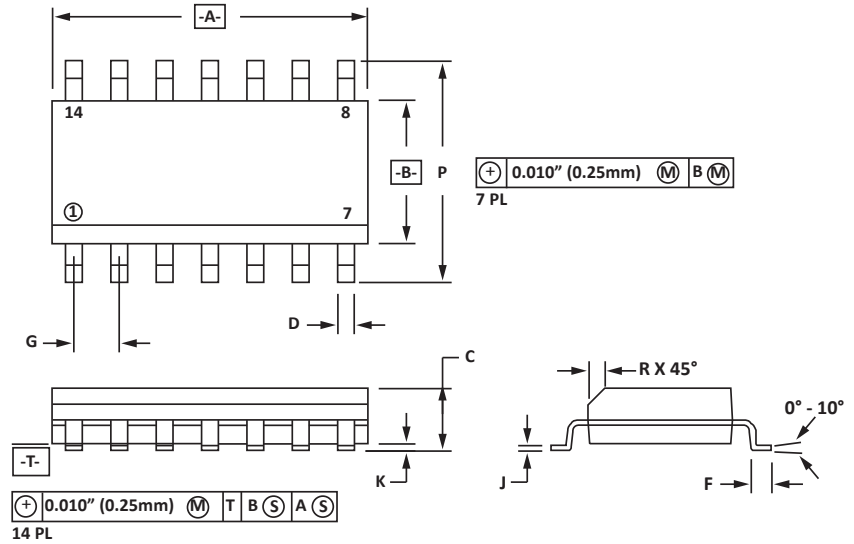

PAD LAYOUT DIMENSIONS

DIM	MILLIMETERS		INCHES	
	MIN	MAX	MIN	MAX
A	1.14	1.40	0.045	0.055
B	0.64	0.89	0.025	0.035
C	6.22	-	0.245	-
D	3.94	4.17	0.155	0.165
E	1.02	1.27	0.040	0.050

NOTES

- Controlling dimension: inches.

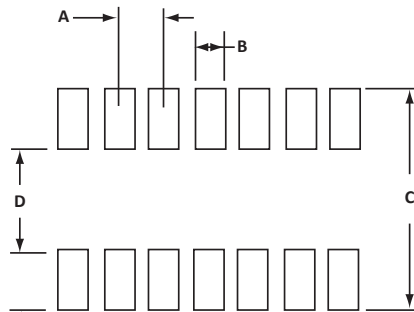

TAPE AND REEL

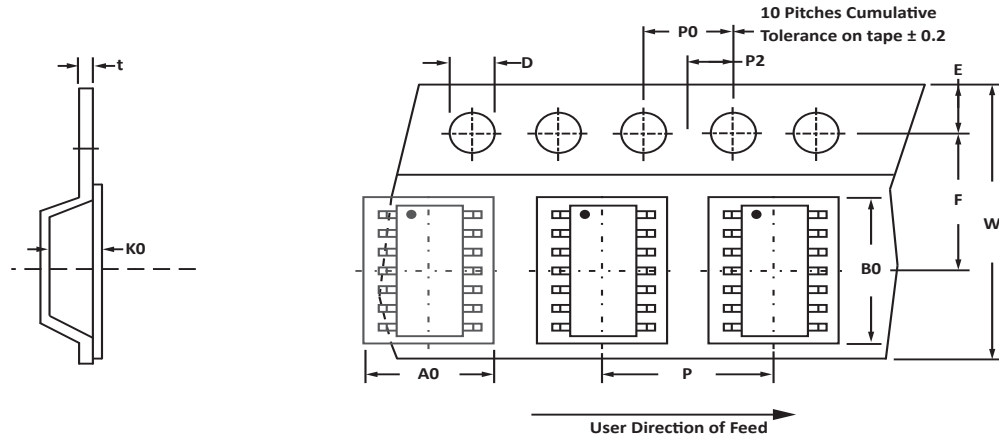

SPECIFICATIONS

REEL DIA.	TAPE WIDTH	A0	B0	K0	D	E	F	W	P0	P2	P	tmax
178mm (7")	16mm	6.70 ± 0.10	9.8 ± 0.10	2.10 ± 0.10	1.50 ± 0.10	1.75 ± 0.10	3.50 ± 0.05	16.00 ± 0.30	4.00 ± 0.12	2.00 ± 0.10	4.00 ± 0.10	0.25

NOTES

- Dimensions are in millimeters.
- Surface mount product is taped and reeled in accordance with EIA-481.
- Suffix - T7 = 7" Reel - 1,000 pieces per 16mm tape.
- Suffix - T13 = 13" Reel - 2,500 pieces per 16mm tape.
- Bulk product shipped in tubes of 55 pieces per tube.
- Marking on Part - part number, date code, logo and pin one defined by dot on top of package.

Package outline per document number 06006.R3 10/09

ORDERING INFORMATION

BASE PART NUMBER (xx = Voltage)	LEADFREE SUFFIX	TAPE SUFFIX	QTY/REEL	REEL SIZE	TUBE QTY
PMMADxxxx	-LF	-T7	1,000	7"	55
PMMADxxxx	-LF	-T13	2,500	13"	55

This device is only available in a Lead-Free configuration.

COMPANY INFORMATION

COMPANY PROFILE

In business more than 20 years, ProTek Devices™ is a privately-held company located in Tempe, Arizona, that offers a product line of transient voltage suppressors (TVS); avalanche breakdown diodes; steering diode TVS arrays and other surge suppressor component products. These TVS devices protect electronic systems from the effects of lightning, electrostatic discharge (ESD), nuclear electromagnetic pulses (NEMP), inductive switching and EMI / RFI. ProTek Devices also offers high performance interface and linear products that include analog switches; multiplexers; LED drivers; audio control ICs; RF and related high frequency products. The analog devices work in a host of consumer; industrial; automotive and other applications.

CONTACT US

Corporate Headquarters

2929 South Fair Lane
Tempe, Arizona 85282
USA

By Telephone

General: 602-431-8101
Sales: & Marketing: 602-414-5109
Customer Service: 602-414-5114
Product Technical Support: 602-414-5107

By Fax

General: 602-431-2288

By E-mail:

Sales: sales@protekdevices.com
Customer Service: service@protekdevices.com
Technical Support: support@protekdevices.com

ProTek Devices (Asia Pacific) Pte. Ltd.

8 Ubi Road 2, #06-19
Zervex
Singapore - 408538
Tel: +65-67488312
Fax: +65-67488313

Web

www.protekdevices.com

COPYRIGHT © ProTek Devices 2000 - This literature is subject to all applicable copyright laws and is not for resale in any manner.

SPECIFICATIONS: ProTek reserves the right to change the electrical and or mechanical characteristics described herein without notice.

DESIGN CHANGES: ProTek reserves the right to discontinue product lines without notice and that the final judgement concerning selection and specifications is the buyer's and that in furnishing engineering and technical assistance. ProTek assumes no responsibility with respect to the selection or specifications of such products. ProTek makes no warranty, representation or guarantee regarding the suitability of its products for any particular purpose, nor does ProTek assume any liability arising out of the application or use of any product or circuit and specifically disclaims any and all liability without limitation special, consequential or incidental damages.

LIFE SUPPORT POLICY: ProTek Devices products are not authorized for use in life support systems without written consent from the factory.