

## MULTI-LINE TVS ARRAY

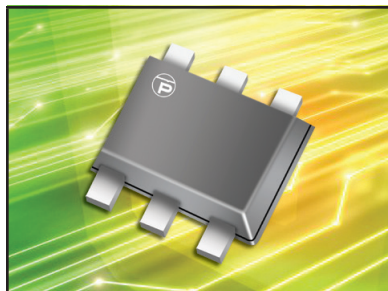

**SOT-563 PACKAGE**

### DESCRIPTION

The MSMFxxC series are multi-line TVS arrays designed to protect wireless telecommunications and portable electronic applications from the damaging effects of ESD and EFT. The MSMFxxC is available in a 5 line unidirectional or 4 line bidirectional configuration and is rated at 100 Watts peak pulse power, which is sufficient protection for tertiary type lightning threats at key interface locations.

Packaged in a miniature SOT-563, the MSMFxxC series meets IEC 61000-4-2 (ESD) and 61000-4-4 (EFT) immunity requirements. Each device should be placed near a connector to provide the best protection against transients.

### FEATURES

- Compatible with IEC 61000-4-2 (ESD): Air 15kV, Contact 8kV
- Compatible with IEC 61000-4-4 (EFT): 40A, 5/50ns
- 100 Watts Peak Pulse Power per Line( $t_p = 8/20\mu s$ )
- Monolithic Design
- Available in Multiple Voltages
- Low Clamping Voltage
- ESD Protection > 25 kilovolts
- Low Leakage Current
- Protects 4 Bidirectional Lines & 5 Unidirectional Lines
- RoHS Compliant
- REACH Compliant

### APPLICATIONS

- Communication Systems
- SMART Phones
- Portable Electronics
- Video Interfaces

### MECHANICAL CHARACTERISTICS

- Molded JEDEC SOT-563 Package
- Approximate Weight: 3 milligrams
- Lead-Free Nickel Paladium Gold Plating
- Solder Reflow Temperature - 260-270°C
- Flammability Rating UL 94V-0
- 8mm Tape and Reel per EIA Standard 481

### PIN CONFIGURATION

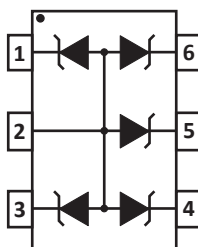

**TYPICAL DEVICE CHARACTERISTICS**
**MAXIMUM RATINGS @ 25°C Unless Otherwise Specified**

PARAMETER	SYMBOL	VALUE	UNITS
Peak Pulse Power (tp = 8/20μs) - See Figure 1	$P_{PP}$	100	Watts
Operating Temperature	$T_L$	-55 to 150	°C
Storage Temperature	$T_{STG}$	-55 to 150	°C
Maximum Forward Voltage @ 10mA	$V_F$	1.0	V

**ELECTRICAL CHARACTERISTICS PER LINE @ 25°C Unless Otherwise Specified**

PART NUMBER	DEVICE MARKING	RATED STAND-OFF VOLTAGE  $V_{WM}$ VOLTS	MINIMUM BREAKDOWN VOLTAGE  @ 1mA $V_{(BR)}$ VOLTS	MAXIMUM CLAMPING VOLTAGE (Fig. 2)  @ 8/20μs $V_C @ I_{PP}$	MAXIMUM LEAKAGE CURRENT  @ $V_{WM}$ $I_D$ μA	TYPICAL CAPACITANCE (Note 1)  @0V, 1MHz C pF
MSMF05C	B	5.0	6.0	12.0V @ 9.0A	1	40
MSMF12C	D	12.0	13.3	23.8V @ 4.2A	1	20
MSMF15C	F	15.0	16.7	33.3V @ 3.0A	1	15
MSMF24C	H	24.0	26.7	55.5V @ 1.8A	1	10

**NOTES**

1. Pins 1, 3, 4, 5 or 6 to pin 2.

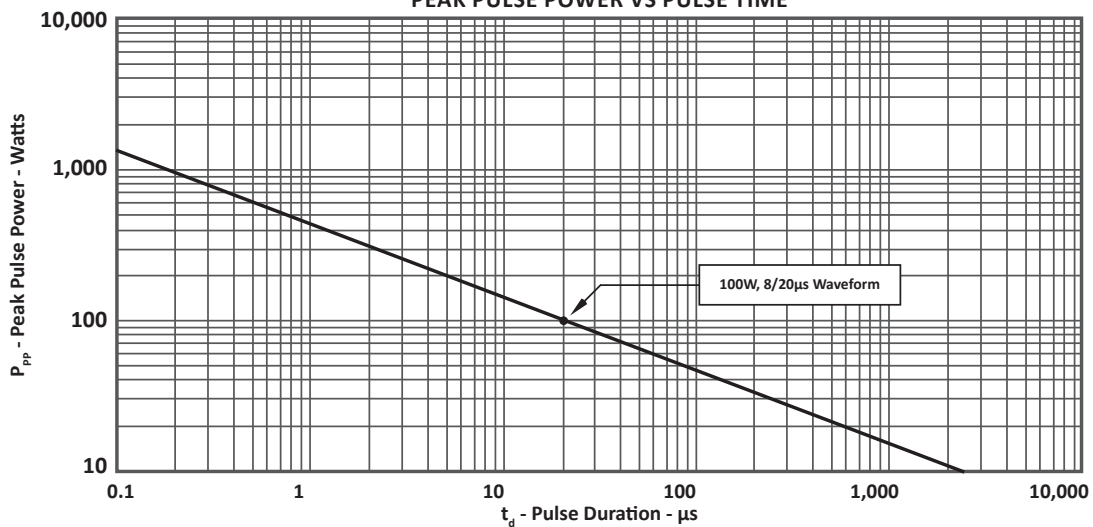
**FIGURE 1  
PEAK PULSE POWER VS PULSE TIME**

## TYPICAL DEVICE CHARACTERISTICS

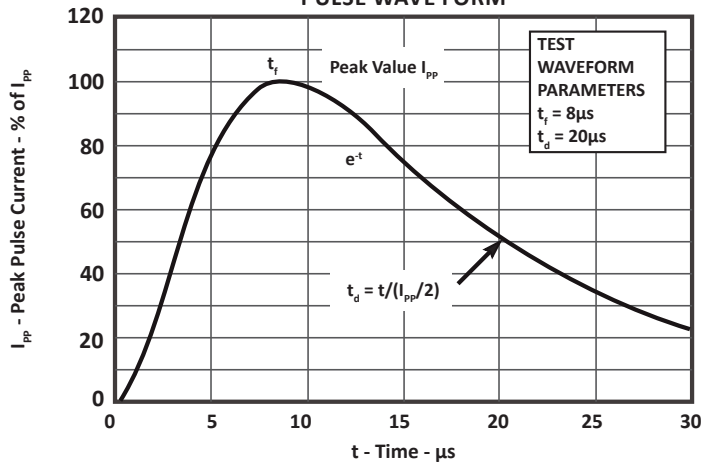
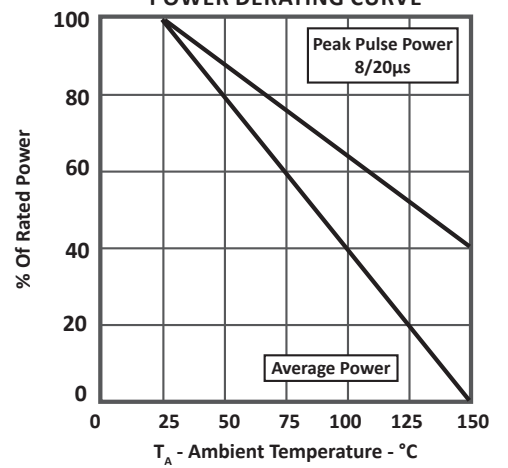
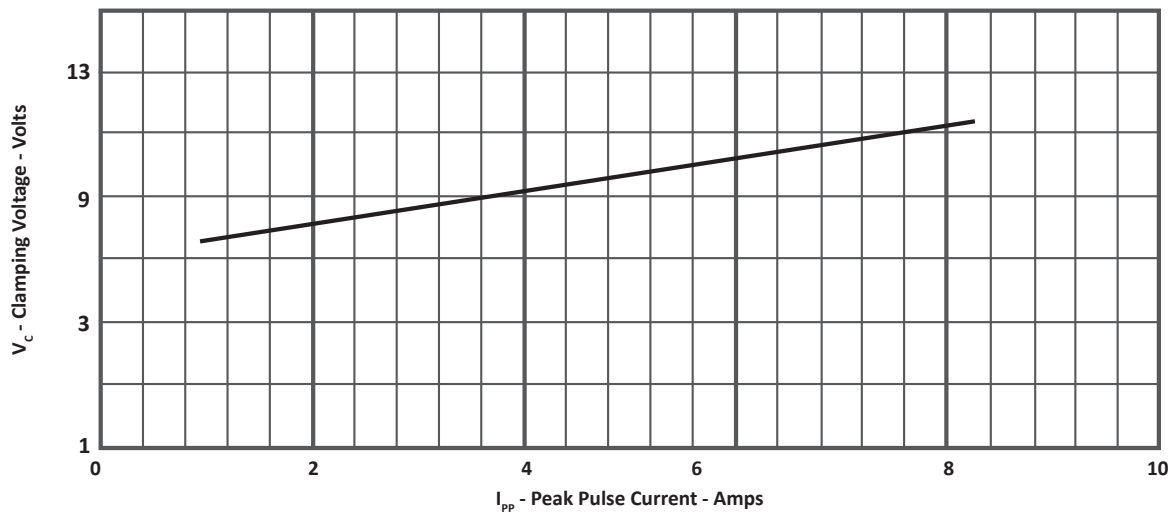
**FIGURE 2**  
**PULSE WAVE FORM**

**FIGURE 3**  
**POWER DERATING CURVE**

**FIGURE 4**  
**TYPICAL CLAMPING VOLTAGE VS PEAK PULSE CURRENT**

## SOT-563 PACKAGE INFORMATION

## OUTLINE DIMENSIONS

DIM	MILLIMETERS		INCHES	
	MIN	MAX	MIN	MAX
A	1.50	1.70	0.059	0.067
B	1.10	1.30	0.043	0.051
C	0.50	0.60	0.020	0.024
D	0.17	0.27	0.007	0.011
G	0.50 BSC		0.020 BSC	
J	0.08	0.18	0.003	0.007
K	0.10	0.30	0.004	0.012
S	1.50	1.70	0.059	0.067

## NOTES

- Controlling dimension: inches.
- Dimensioning and tolerances per ANSI Y14.5M, 1985.
- Dimensions are exclusive of mold flash and metal burrs.

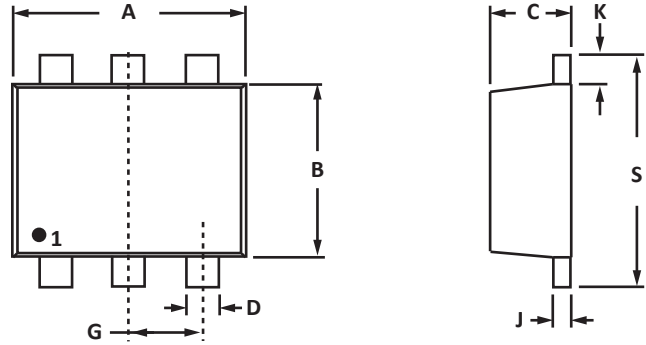

## PAD LAYOUT DIMENSIONS

DIM	MILLIMETERS	INCHES
	NOMINAL	NOMINAL
A	1.40	0.055
B	1.02	0.040
C	0.30	0.012
D	0.51	0.020
E	0.51	0.020

## NOTES

- Controlling dimension: inches.

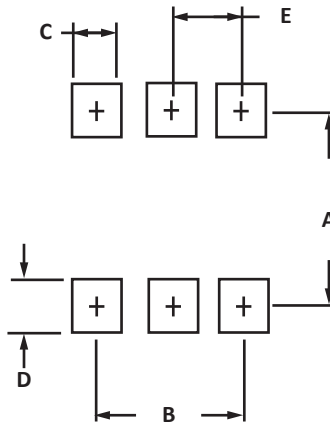

## TAPE AND REEL

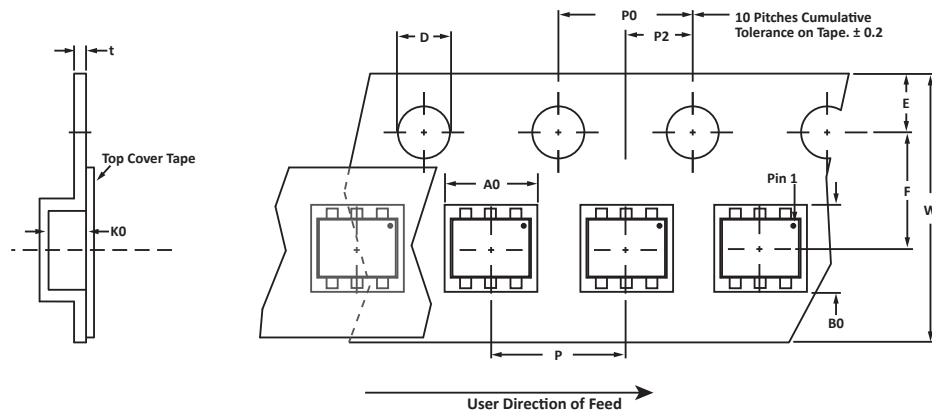

## SPECIFICATIONS

REEL DIA.	TAPE WIDTH	A0	B0	K0	D	E	F	W	P0	P2	P	tmax
178mm (7")	8mm	1.78 ± 0.05	1.78 ± 0.05	0.69 ± 0.05	1.50 ± 0.10	1.75 ± 0.10	3.50 ± 0.05	8.00 ± 0.30	4.00 ± 0.10	2.00 ± 0.05	4.00 ± 0.10	0.25

## NOTES

- Dimensions are in millimeters.
- Surface mount product is taped and reeled in accordance with EIA-481.
- Suffix - T7 = 7" Reel - 3,000 pieces per 8mm tape.
- Suffix - T13 = 13" Reel - 10,000 pieces per 8mm tape.
- Marking on Part - marking code (see page 2) and pin one defined by dot on package.

## ORDERING INFORMATION

BASE PART NUMBER (xx = Voltage)	LEADFREE SUFFIX	TAPE SUFFIX	QTY/REEL	REEL SIZE	TUBE QTY
MSMFxxC	-P	-T7	3,000	7"	n/a
MSMFxxC	-P	-T13	10,000	13"	n/a

This device is only available in a Lead-Free configuration.

## COMPANY INFORMATION

---

### COMPANY PROFILE

In business more than 20 years, ProTek Devices™ is a privately held semiconductor company. The company offers a product line of overvoltage protection and overcurrent protection components. These include transient voltage suppressor array (TVS arrays) avalanche breakdown diode, steering diode TVS array and electronics SMD chip fuses. These components deliver circuit protection in electronic systems from numerous overvoltage and overcurrent events. They include lightning; electrostatic discharge (ESD); nuclear electromagnetic pulses (NEMP); inductive switching; and electromagnetic interference (EMI) / radio frequency interference (RFI). ProTek Devices also offers high performance interface and linear products. They include analog switches; multiplexers; LED drivers; LED wafer die for ESD protection; audio control ICs; RF and related high frequency products.

### CONTACT US

#### Corporate Headquarters

2929 South Fair Lane  
Tempe, Arizona 85282  
USA

#### By Telephone

General: 602-431-8101  
Sales: & Marketing: 602-414-5109  
Customer Service: 602-414-5114  
Product Technical Support: 602-414-5107

#### By Fax

General: 602-431-2288

#### By E-mail:

Sales: [sales@protekdevices.com](mailto:sales@protekdevices.com)  
Customer Service: [service@protekdevices.com](mailto:service@protekdevices.com)  
Technical Support: [support@protekdevices.com](mailto:support@protekdevices.com)

#### ProTek Devices (Asia Pacific) Pte. Ltd.

8 Ubi Road 2, #06-19  
Zervex  
Singapore - 408538  
Tel: +65-67488312  
Fax: +65-67488313

#### Web

[www.protekdevices.com](http://www.protekdevices.com)

COPYRIGHT © ProTek Devices 2005 - This literature is subject to all applicable copyright laws and is not for resale in any manner.

SPECIFICATIONS: ProTek reserves the right to change the electrical and or mechanical characteristics described herein without notice.

DESIGN CHANGES: ProTek reserves the right to discontinue product lines without notice and that the final judgement concerning selection and specifications is the buyer's and that in furnishing engineering and technical assistance. ProTek assumes no responsibility with respect to the selection or specifications of such products. ProTek makes no warranty, representation or guarantee regarding the suitability of its products for any particular purpose, nor does ProTek assume any liability arising out of the application or use of any product or circuit and specifically disclaims any and all liability without limitation special, consequential or incidental damages.

LIFE SUPPORT POLICY: ProTek Devices products are not authorized for use in life support systems without written consent from the factory.