

HIGH POWERED MULTI-LINE TVS ARRAY

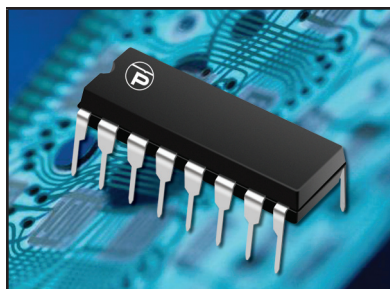

16 PIN DIP PACKAGE

DESCRIPTION

The LCD Series are high powered multi-line TVS arrays available in a 16 pin DIP package. This series is designed to protect high-speed applications from the damaging effects of ESD, EFT and secondary transient threats.

The LCD Series has a peak pulse power rating of 800 Watts for an 8/20 μ s waveshape. This devices meets the IEC 61000-4-2, IEC 61000-4-4 and IEC 61000-4-5 requirements.

FEATURES

- Compatible with IEC 61000-4-2 (ESD): Air - 15kV, Contact - 8kV
- Compatible with IEC 61000-4-4 (EFT): 40A - 5/50ns
- Compatible with IEC 61000-4-5 (Surge): 24A, 8/20 μ s - Level 2(Line-Gnd) & Level 3(Line-Line)
- 800 Watts Peak Pulse Power per Line (tp = 8/20 μ s)
- Bidirectional Configuration
- ESD Protection > 25 kilovolts
- Available in Multiple Voltages
- Protects up to 8 Lines
- Low Capacitance: 15pF
- RoHS Compliant
- REACH Compliant

APPLICATIONS

- Ethernet 10/100 Base T
- RS-485
- xDSL & ATM
- SCSI & USB Interfaces
- Audio/Video I/O Ports

MECHANICAL CHARACTERISTICS

- Molded 16 Pin Dual-In-Line (DIP) Package
- Approximate Weight: 1.2 grams
- Lead-Free Pure-Tin Plating (Annealed)
- Solder Reflow Temperature:
Pure-Tin - Sn, 100: 260-270°C
- Flammability Rating UL 94V-0

PIN CONFIGURATION

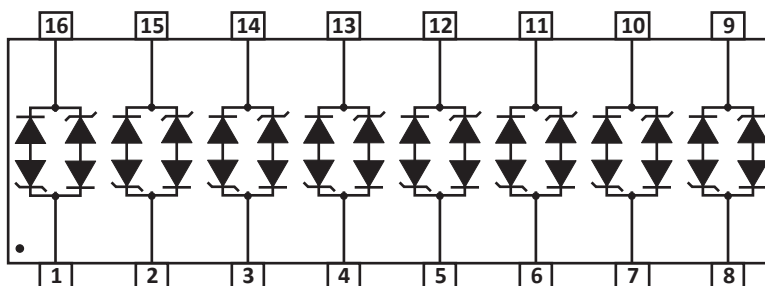

TYPICAL DEVICE CHARACTERISTICS
MAXIMUM RATINGS @ 25°C Unless Otherwise Specified

PARAMETER	SYMBOL	VALUE	UNITS
Peak Pulse Power (tp = 8/20μs) - See Figure 1	P _{PP}	800	Watts
Operating Temperature	T _L	-55 to 150	°C
Storage Temperature	T _{STG}	-55 to 150	°C

ELECTRICAL CHARACTERISTICS PER LINE @ 25°C Unless Otherwise Specified

PART NUMBER (Note 1)	RATED STAND-OFF VOLTAGE V _{WM} VOLTS	MINIMUM BREAKDOWN VOLTAGE @1mA V _(BR) VOLTS	MAXIMUM CLAMPING VOLTAGE (Fig. 2) @ IP = 1A V _C VOLTS	MAXIMUM CLAMPING VOLTAGE (Fig. 2) @ 8/20μs V _C @ I _{PP}	MAXIMUM LEAKAGE CURRENT @V _{WM} I _D μA	MAXIMUM CAPACITANCE @0V, 1MHz C pF	TEMPERATURE COEFFICIENT OF V _(BR) q V _(BR) mV/°C
LCD05C	5.0	6.0	9.8	24.0V @ 45.0A	100	15	3
LCD08C	8.0	8.5	12.3	25.5V @ 40.0A	10	15	9
LCD12C	12.0	13.3	19.0	32.0V @ 34.0A	4	15	16
LCD15C	15.0	16.7	25.5	38.0V @ 27.0A	4	15	17
LCD24C	24.0	26.7	40.0	48.0V @ 22.0A	4	15	26

NOTES

1. Tested on pin pairs 1 and 16, 2 and 15, 3 and 14, 4 and 13, 5 and 12, 6 and 11, 7 and 10, 8 and 9.

TYPICAL DEVICE CHARACTERISTICS

FIGURE 1
PEAK PULSE POWER VS PULSE TIME

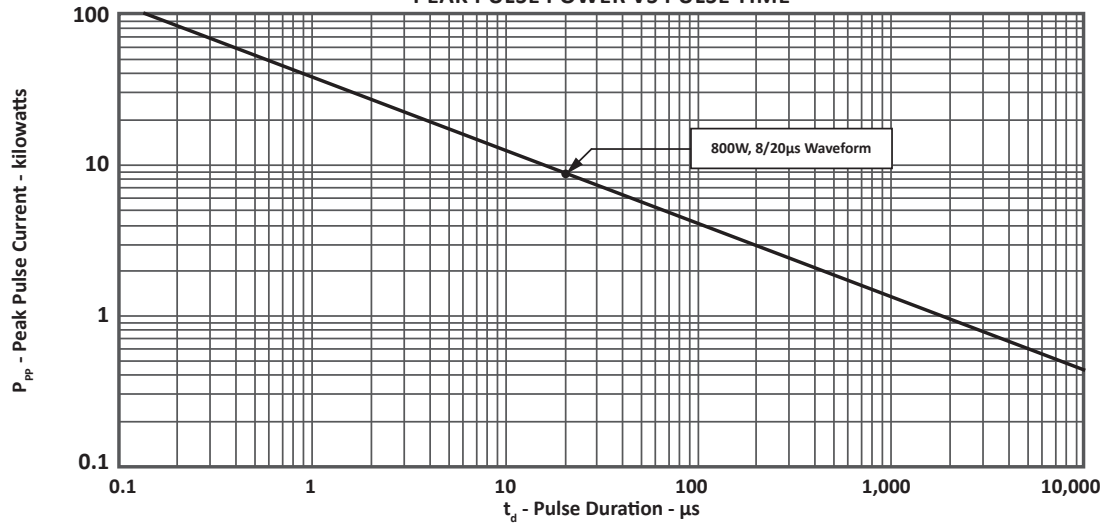
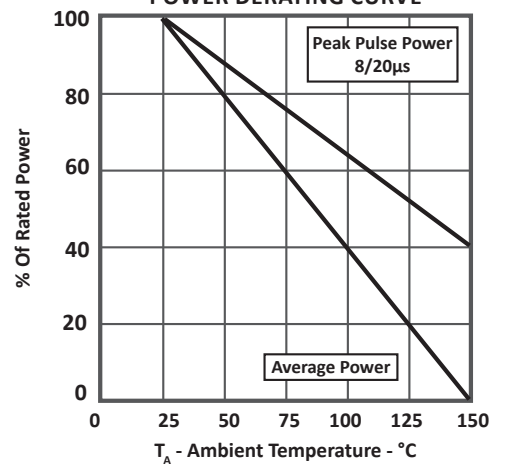

FIGURE 2
PULSE WAVE FORM



FIGURE 3
POWER DERATING CURVE



TYPICAL DEVICE CHARACTERISTICS

FIGURE 4
OVERSHOOT & CLAMPING VOLTAGE FOR LCD05C

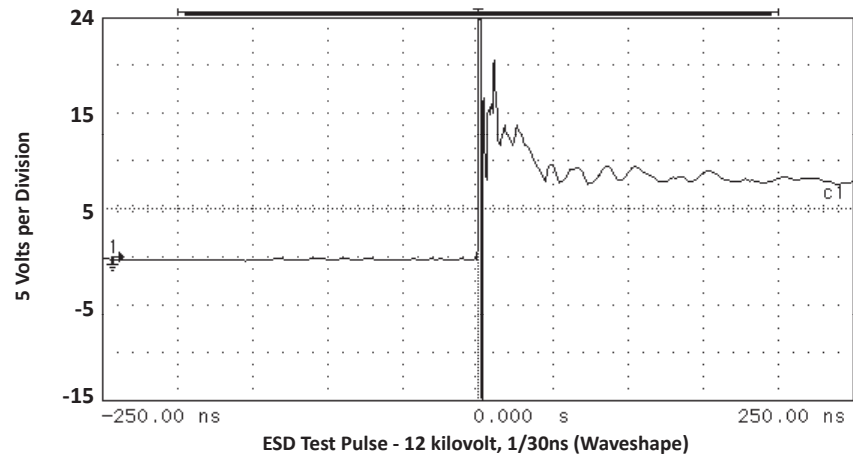
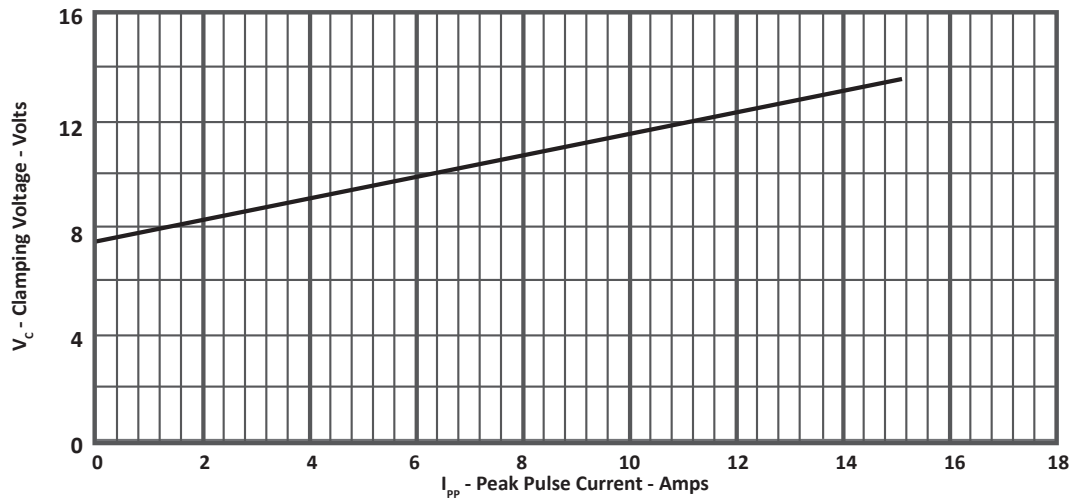
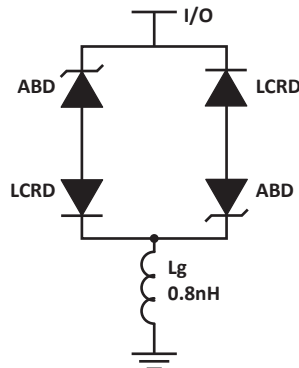

FIGURE 5
TYPICAL CLAMPING VOLTAGE VS PEAK PULSE CURRENT FOR LCD05C



SPICE MODEL

FIGURE 1
SPICE MODEL



ABD - Avalanche Breakdown Diode (TVS)
 LCRD: Low Capacitance Rectifier Diode
 Lg - Lead Inductance

TABLE 1 - SPICE PARAMETERS

PARAMETER	UNIT	ABD(TVS)	LCRD
BV	V	See Table 2	200
IBV	μA	1	0.01
C_{jo}	pF	See Table 2	5
I_s	A	See Table 2	1E-13
Vj	V	0.6	0.6
M	-	0.33	0.33
N	-	1	1
R_s	Ohms	See Table 2	0.31
TT	s	1E-8	1E-9
EG	eV	1.11	1.11

TABLE 2 - ABD SPECIFIC SPICE PARAMETERS

PART NUMBER	B_v (VOLTS)	C_{jo} (pF)	I_s (AMPS)	R_s (OHMS)
LCD05C	6.0	880	1E-11	0.09
LCD08C	8.5	481	1E-13	0.18
LCD12C	13.3	319	1E-13	0.22
LCD15C	16.7	238	1E-13	0.31
LCD24C	26.7	210	1E-13	0.93

APPLICATION INFORMATION

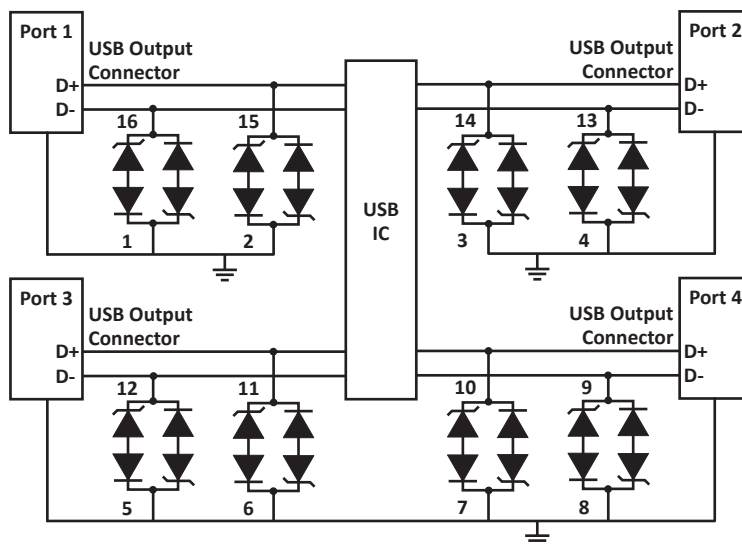

FIGURE 1 - COMMON-MODE USB PROTECTION

Circuit connectivity is as follows:

- Pins 1, 2, 3, 4, 5, 6, 7 and 8 connected to ground.
- Pins 16 and 15 connected to Port 1, D- and D+.
- Pins 14 and 13 connected to Port 2, D- and D+.
- Pins 12 and 11 connected to Port 3, D- and D+.
- Pins 10 and 9 connected to Port 4, D- and D+.

CIRCUIT BOARD RECOMMENDATIONS

Circuit board layout is critical for electromagnetic compatibility protection. The following guidelines are recommended:

- The protection device should be placed near the input terminals or connectors, the device will divert the transient current immediately before it can be coupled into the nearby traces.
- The path length between the TVS device and the protected line should be minimized.
- All conductive loops including power and ground loops should be minimized.
- The transient current return path to ground should be kept as short as possible to reduce parasitic inductance.
- Ground planes should be used whenever possible. For multilayer PCBs, use ground vias.

16 PIN DIP PACKAGE INFORMATION

OUTLINE DIMENSIONS

DIM	MILLIMETERS		INCHES	
	MIN	MAX	MIN	MAX
A	18.80	19.55	0.740	0.770
B	6.35	6.85	0.250	0.270
C	7.50	7.74	0.295	0.305
D	0.21	0.38	0.008	0.015
E	0°	10°	0°	10°
F	0.51	1.01	0.020	0.040
G	3.69	4.44	0.145	0.175
H	2.80	3.30	0.110	0.130
I	1.02	1.77	0.040	0.070
J	0.76	1.52	0.030	0.060
K	0.39	0.53	0.015	0.021
L	2.54	2.54	0.100	0.100

NOTES

- Dimensions are exclusive of mold flash and metal burrs.
- Dimension "L" is between centers.

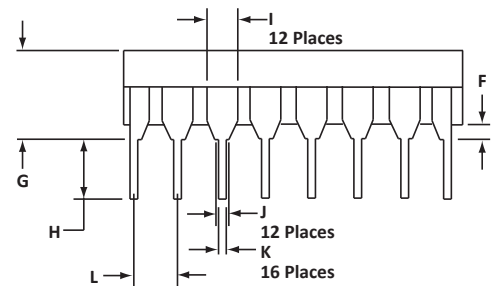
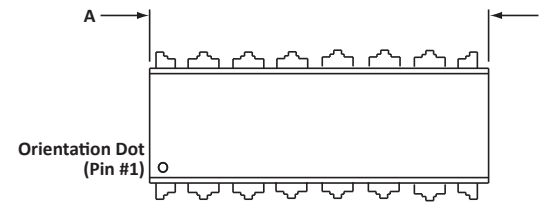
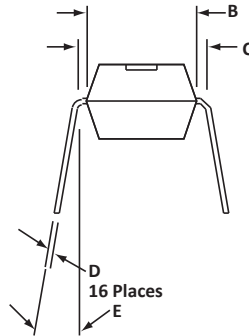

ORDERING INFORMATION

BASE PART NUMBER (xx = Voltage)	LEADFREE SUFFIX	TAPE SUFFIX	QTY/REEL	REEL SIZE	TUBE QTY
LCDxxC	-LF	n/a	n/a	n/a	25

NOTES

- Marking on Part - logo, part number, date code and pin one defined by dot on top of package.
- This series is only available in a lead-free configuration.

Package outline per document number 06003.R3 10/11.

COMPANY INFORMATION

COMPANY PROFILE

In business more than 20 years, ProTek Devices™ is a privately-held company located in Tempe, Arizona, that offers a product line of transient voltage suppressors (TVS); avalanche breakdown diodes; steering diode TVS arrays and other surge suppressor component products. These TVS devices protect electronic systems from the effects of lightning, electrostatic discharge (ESD), nuclear electromagnetic pulses (NEMP), inductive switching and EMI / RFI. ProTek Devices also offers high performance interface and linear products that include analog switches; multiplexers; LED drivers; audio control ICs; RF and related high frequency products. The analog devices work in a host of consumer; industrial; automotive and other applications.

CONTACT US

Corporate Headquarters

2929 South Fair Lane
Tempe, Arizona 85282
USA

By Telephone

General: 602-431-8101
Sales: & Marketing: 602-414-5109
Customer Service: 602-414-5114
Product Technical Support: 602-414-5107

By Fax

General: 602-431-2288

By E-mail:

Sales: sales@protekdevices.com
Customer Service: service@protekdevices.com
Technical Support: support@protekdevices.com

ProTek Devices (Asia Pacific) Pte. Ltd.

8 Ubi Road 2, #06-19
Zervex
Singapore - 408538
Tel: +65-67488312
Fax: +65-67488313

Web

www.protekdevices.com

COPYRIGHT © ProTek Devices 1998 - This literature is subject to all applicable copyright laws and is not for resale in any manner.

SPECIFICATIONS: ProTek reserves the right to change the electrical and or mechanical characteristics described herein without notice.

DESIGN CHANGES: ProTek reserves the right to discontinue product lines without notice and that the final judgement concerning selection and specifications is the buyer's and that in furnishing engineering and technical assistance. ProTek assumes no responsibility with respect to the selection or specifications of such products. ProTek makes no warranty, representation or guarantee regarding the suitability of its products for any particular purpose, nor does ProTek assume any liability arising out of the application or use of any product or circuit and specifically disclaims any and all liability without limitation special, consequential or incidental damages.

LIFE SUPPORT POLICY: ProTek Devices products are not authorized for use in life support systems without written consent from the factory.