

VGAP-CLB-AS-A1 Specification

1. Features and Application :

- (1) This product is manufactured in ISO/TS16949 certified production factory.
- (2) This product is qualified according to AEC-Q200.
- (3) This product is for 2.4/5 GHz Dual Band WiFi, 802.11 b/g/n, Zigbee, Bluetooth,...

2. Explanation of Part Number :

VGAP - $\frac{\text{C}}{(1)}$ $\frac{\text{LB}}{(2)}$ - $\frac{\text{A}}{(3)}$ $\frac{\text{S}}{(4)}$ - $\frac{\text{A1}}{(5)}$

- (1) Product Type : Chip Antenna
- (2) Center Frequency/Band Code : 2.4/5 GHz Dual-Band
- (3) Size Code : 5.0*3.6 mm (Length * Width)
- (4) Special Code : RoHS Compliant
- (5) Design Revision Code : Rev.1

3. Electrical Specification :

Item	Specification	
Frequency Band	2400 ~ 2500 MHz	5000 ~ 6000 MHz
Polarization	Linear	
Impedance	50 ohm Typ.	
VSWR	Less than 2.0	Less than 2.0
*Peak Gain	3.2 dBi Typ.	3.5 dBi Typ.
*Peak Efficiency	74.8% Typ.	81.6% Typ.

* Test condition : Test board size 80*40 mm
Matching circuit may be required

UNLESS OTHER SPECIFIED TOLERANCES ON :

X=± X.X=± X.XX= ANGLE=± HOLEDIA=±



INPAQ TECHNOLOGY CO., LTD.

SCALE : -----

UNIT : mm

DRAWN BY : 彭少君

CHECKED BY : 黃月碧

DESIGNED BY : 彭少君

APPROVED BY : 謝立庭

THIS DRAWINGS AND SPECIFICATIONS ARE THE PROPERTY OF INPAQ TECHNOLOGY CO.,LTD.AND SHALL NOT BE REPRODUCED OR USED AS THE BASIS FOR THE MANUFACTURE OR SALE OF APPARATUS OR DEVICES WITHOUT PERMISSION

TITLE : VGAP-CLB-AS-A1 Specification

DOCUMENT NO.

ENS000061960

SPEC REV.

A5

4. Physical Dimension :

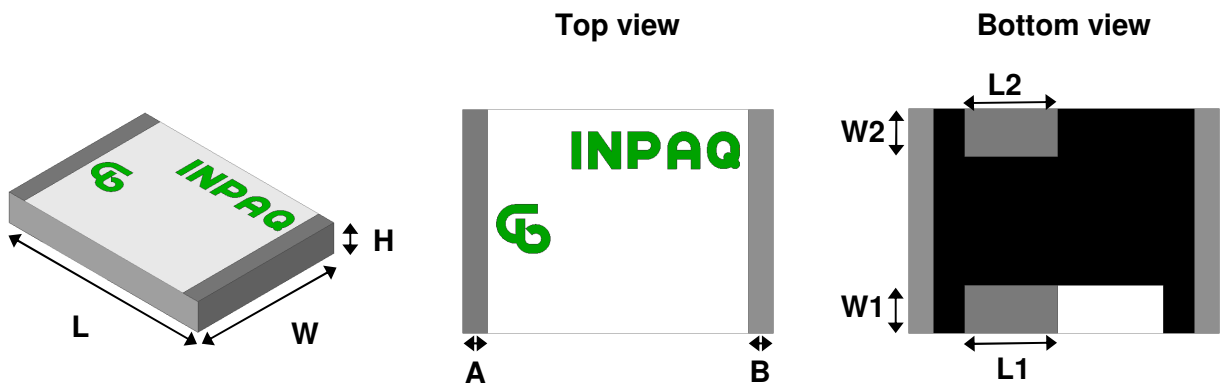

Marking is Green

L	5.20 ± 0.30
W	3.70 ± 0.30
H	0.70 ± 0.15
A	0.45 ± 0.25
B	0.45 ± 0.25
L1	1.60 ± 0.20
W1	0.62 ± 0.20
L2	1.50 ± 0.20
W2	0.62 ± 0.20

(Unit: mm)

Pin Configuration

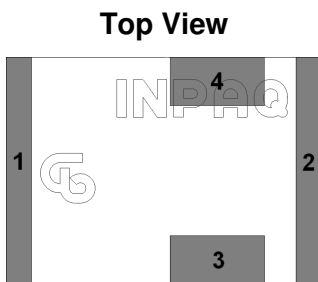

Pin Assignments

Layout	
Pin	Function
1	GND
2	GND
3	Feed
4	No connect

Mirror Layout	
Pin	Function
1	GND
2	GND
3	No connect
4	Feed

UNLESS OTHER SPECIFIED TOLERANCES ON :

X=± X.X=± X.XX= ANGLE=± HOLEDIA=±



INPAQ TECHNOLOGY CO., LTD.

SCALE : -----

UNIT : mm

DRAWN BY : 彭少君

CHECKED BY : 黃月碧

DESIGNED BY : 彭少君

APPROVED BY : 謝立庭

THIS DRAWINGS AND SPECIFICATIONS ARE THE PROPERTY OF INPAQ TECHNOLOGY CO.,LTD.AND SHALL NOT BE REPRODUCED OR USED AS THE BASIS FOR THE MANUFACTURE OR SALE OF APPARATUS OR DEVICES WITHOUT PERMISSION

TITLE : VGAP-CLB-AS-A1 Specification

DOCUMENT NO.

ENS000061960

SPEC REV.

A5

5. Recommend PCB Layout :

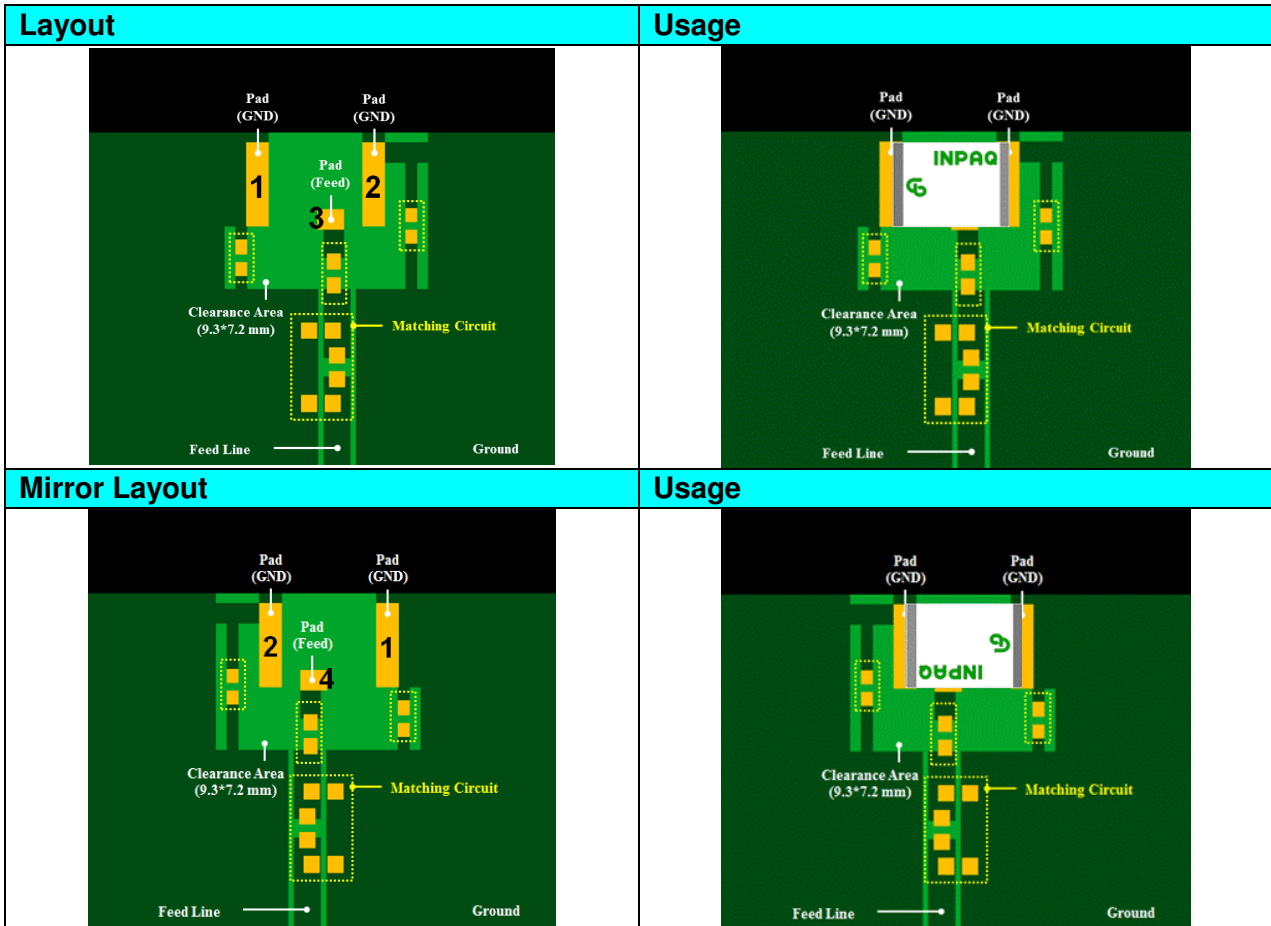

Pad Dimensions on PCB Layout

Top View

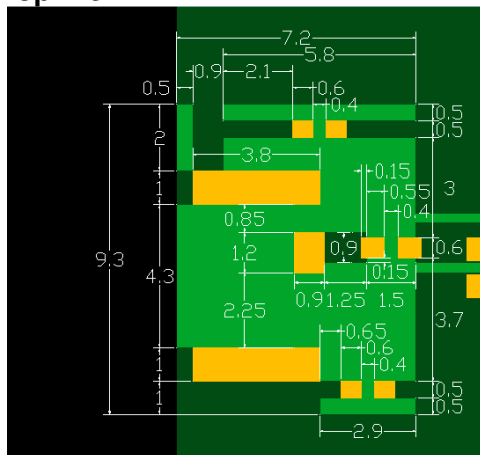

Perspective View

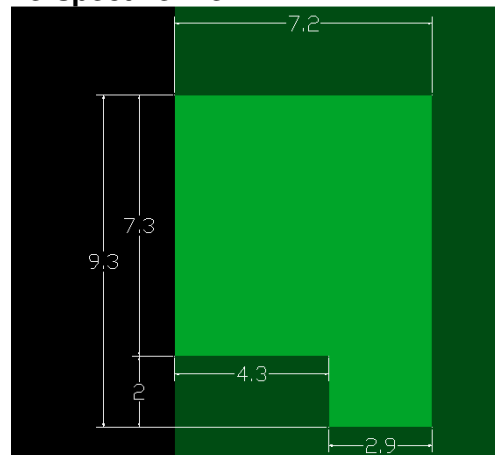

(Unit : mm)

UNLESS OTHER SPECIFIED TOLERANCES ON :

X=± X.X=± X.XX= ANGLES=± HOLEDIA=±



INPAQ TECHNOLOGY CO., LTD.

SCALE : -----

UNIT : mm

DRAWN BY : 彭少君

CHECKED BY : 黃月碧

DESIGNED BY : 彭少君

APPROVED BY : 謝立庭

THIS DRAWINGS AND SPECIFICATIONS ARE THE PROPERTY OF INPAQ TECHNOLOGY CO.,LTD.AND SHALL NOT BE REPRODUCED OR USED AS THE BASIS FOR THE MANUFACTURE OR SALE OF APPARATUS OR DEVICES WITHOUT PERMISSION

TITLE : VGAP-CLB-AS-A1 Specification

DOCUMENT NO.

ENS000061960

SPEC REV. A5

6. Electrical Characteristics :

VSWR

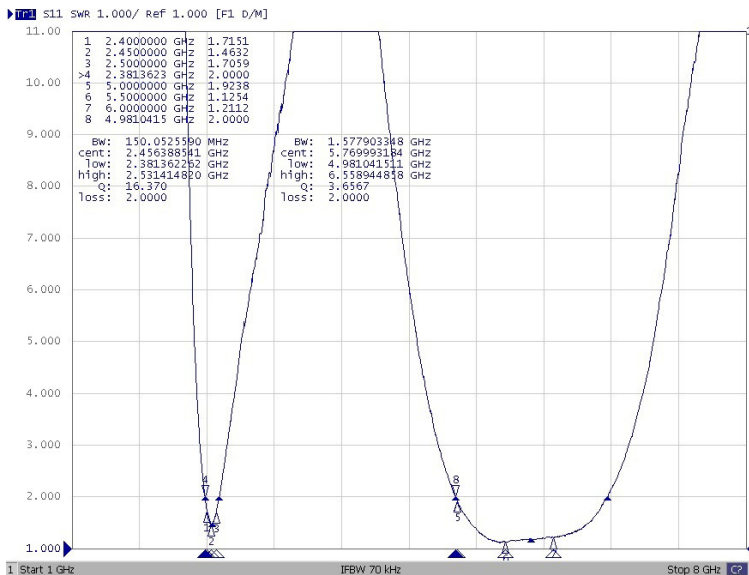

Frequency (MHz)	VSWR
2400	1.7
2450	1.5
2500	1.7
5000	1.9
5500	1.1
6000	1.2

Radiation Pattern

The Gain pattern is measured in INPAQ's FAR-field chamber. DUT is placed on the table of rotator, a standard horn antenna and Vector Network Analyzer is used to collect data.

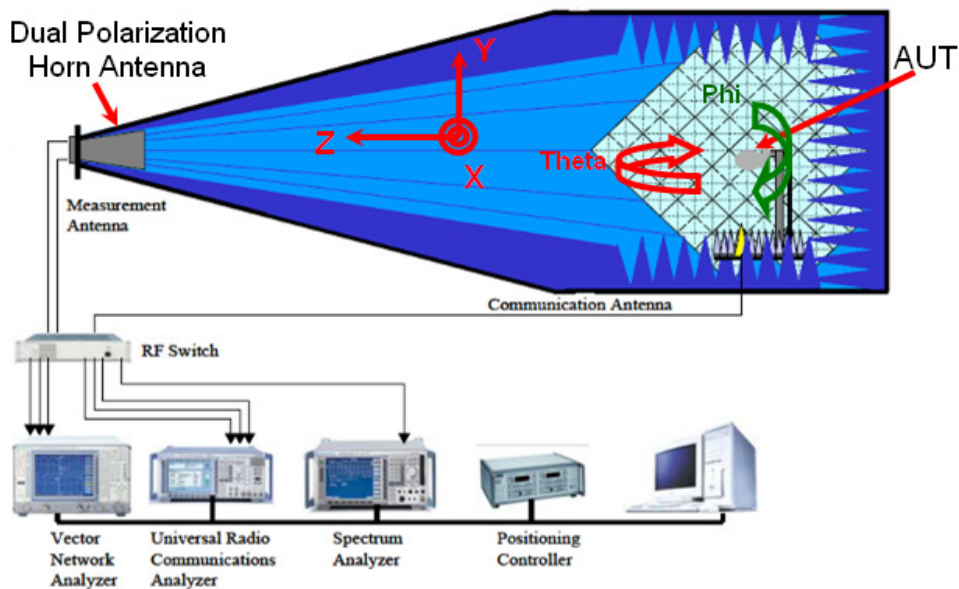

3D Chamber Definition

UNLESS OTHER SPECIFIED TOLERANCES ON :

X=± X.X=± X.XX=±
 ANGLES=± HOLEDIA=±



INPAQ TECHNOLOGY CO., LTD.

SCALE : -----

UNIT : mm

DRAWN BY : 彭少君

CHECKED BY : 黃月碧

DESIGNED BY : 彭少君

APPROVED BY : 謝立庭

THIS DRAWINGS AND SPECIFICATIONS ARE THE PROPERTY OF INPAQ TECHNOLOGY CO.,LTD.AND SHALL NOT BE REPRODUCED OR USED AS THE BASIS FOR THE MANUFACTURE OR SALE OF APPARATUS OR DEVICES WITHOUT PERMISSION

TITLE : VGAP-CLB-AS-A1 Specification

DOCUMENT NO.

ENS000061960

SPEC REV.

A5

3D Gain Pattern

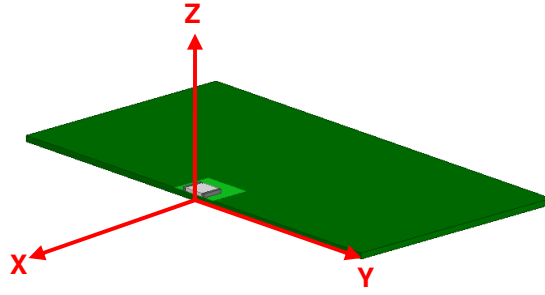

2450 MHz

Azimuth = 109.4
Elevation = -41.6
Roll = -51.0

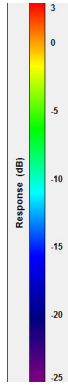
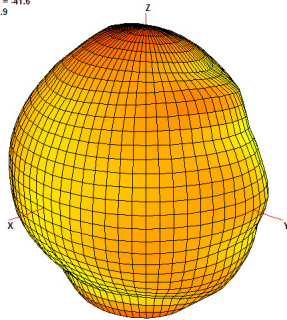

Azimuth = 74.4
Elevation = 31.9
Roll = -51.2

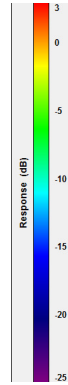
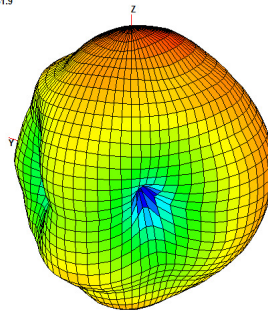

5500 MHz

Azimuth = 107.9
Elevation = -47.9
Roll = -57.1

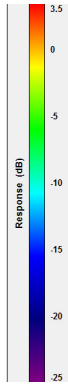
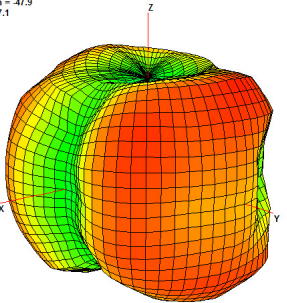

Azimuth = -71.5
Elevation = 28.6
Roll = -55.7

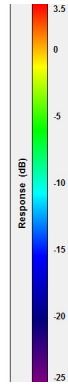
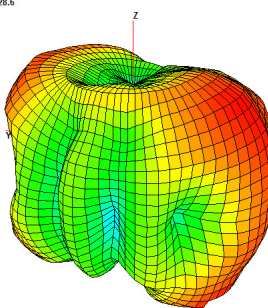

UNLESS OTHER SPECIFIED TOLERANCES ON :

X=± X.X=± X.XX=
 ANGLES=± HOLEDIA=±



INPAQ TECHNOLOGY CO., LTD.

SCALE : -----

UNIT : mm

DRAWN BY : 彭少君

CHECKED BY : 黃月碧

DESIGNED BY : 彭少君

APPROVED BY : 謝立庭

THIS DRAWINGS AND SPECIFICATIONS ARE THE PROPERTY OF INPAQ TECHNOLOGY CO.,LTD.AND SHALL NOT BE REPRODUCED OR USED AS THE BASIS FOR THE MANUFACTURE OR SALE OF APPARATUS OR DEVICES WITHOUT PERMISSION

TITLE : VGAP-CLB-AS-A1 Specification

DOCUMENT NO.

ENS000061960

SPEC REV.
A5

Efficiency

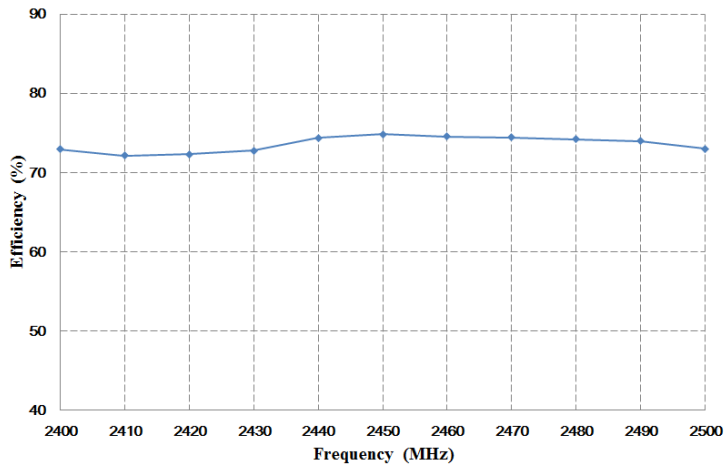

Frequency (MHz)	Efficiency (%)
2400	72.9
2450	74.8
2500	73.0
5000	74.3
5500	81.6
6000	71.9

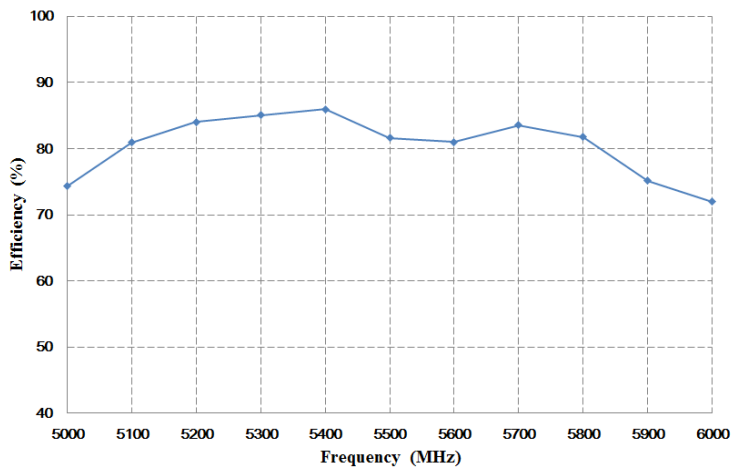

UNLESS OTHER SPECIFIED TOLERANCES ON :

X=± X.X=± X.XX=
 ANGLES=± HOLEDIA=±



INPAQ TECHNOLOGY CO., LTD.

SCALE : -----

UNIT : mm

DRAWN BY : 彭少君

CHECKED BY : 黃月碧

DESIGNED BY : 彭少君

APPROVED BY : 謝立庭

THIS DRAWINGS AND SPECIFICATIONS ARE THE PROPERTY OF INPAQ TECHNOLOGY CO.,LTD.AND SHALL NOT BE REPRODUCED OR USED AS THE BASIS FOR THE MANUFACTURE OR SALE OF APPARATUS OR DEVICES WITHOUT PERMISSION

TITLE : VGAP-CLB-AS-A1 Specification

DOCUMENT NO.

ENS000061960

SPEC REV.
A5

7. Taping Package and Label Marking :

- (1) Quantity/Reel : 2000pcs/Reel
- (2) Carrier tape dimensions

(Unit : mm)

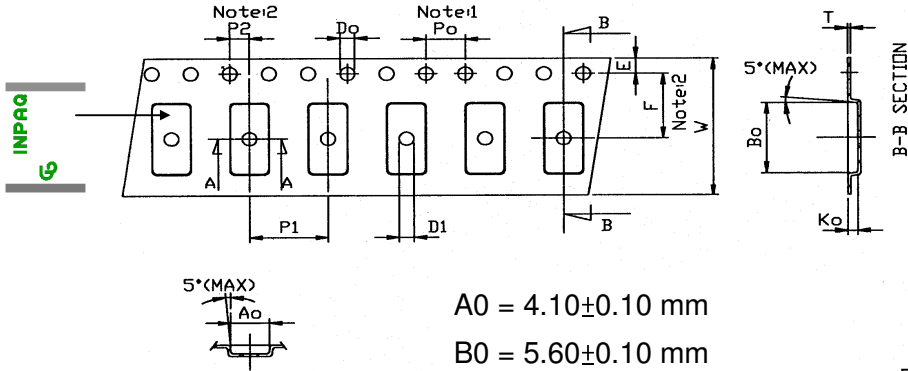

Symbol	Spec.
Po	4.00±0.1
P1	8.00±0.1
P2	2.00±0.05
Do	1.55±0.05
D1	1.50(MIN)
E	1.75±0.1
F	5.50±0.05
10Po	40.00±0.2
W	12.00±0.1
T	0.25±0.05

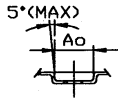

A0 = 4.10±0.10 mm
 B0 = 5.60±0.10 mm
 K0 = 1.02±0.10 mm



- (3) Taping reel dimensions

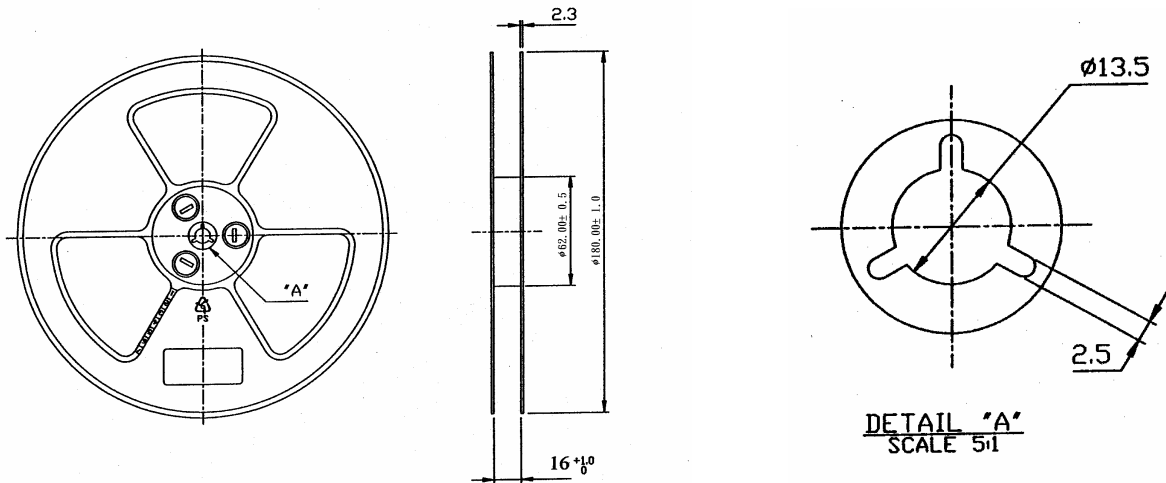

UNLESS OTHER SPECIFIED TOLERANCES ON :

X=± X.X=± X.XX= ANGLES=± HOLEDIA=±



INPAQ TECHNOLOGY CO., LTD.

SCALE : -----

UNIT : mm

DRAWN BY : 彭少君

CHECKED BY : 黃月碧

DESIGNED BY : 彭少君

APPROVED BY : 謝立庭

THIS DRAWINGS AND SPECIFICATIONS ARE THE PROPERTY OF INPAQ TECHNOLOGY CO.,LTD.AND SHALL NOT BE REPRODUCED OR USED AS THE BASIS FOR THE MANUFACTURE OR SALE OF APPARATUS OR DEVICES WITHOUT PERMISSION

TITLE : VGAP-CLB-AS-A1 Specification

DOCUMENT NO.

ENS000061960

SPEC REV.

A5

8. Environmental Characteristics :

This product is qualified according to AEC-Q200.

(1) Reliability Test

Item	Condition	Specification
High Temperature Storage	150°C , 1000hours	No Damaged
Temperature Cycling	-55°C 30min/125°C 30min , 1000 cycle	No Damaged
Biased Humidity	85°C 、85% RH , 1000hours	No Damaged
Resistance to Solvent	Add Aqueous wash chemical OKEMCLEAN for 5 min	No Damaged
Mechanical Shock	1500G 0.5 ms , X,Y,Z axis 3 time	No Damaged
Vibration	1. Frequency : 10 to 2000 Hz 2. 5g's for 20 min 3. Duration time : 2hr for each in X ,Y,Z	No Damaged
Resistance to Soldering Heat	Brush flux and put the board into solder bath 260°C , 10sec.	No Damaged
Solderability Test	1. 8 hours ± 15 min. steam conditioning 2. Put the sample on board by tape. 3. Brush flux and put the board into solder bath 260±5°C , 5±1 sec	No Damaged
Board Flex	2mm for 60sec.	No Damaged
Termination strength (SMD)	1.8Kgf , 60sec	No Damaged

(2) Storage condition

(a) At warehouse :

The temperature should be within 0 ~ 30°C and humidity should be less than 60% RH.

The product should be used within 1 year from the time of delivery.

(b) On board :

The temperature should be within -40 ~ 85°C and humidity should be less than 85% RH.

UNLESS OTHER SPECIFIED TOLERANCES ON :			INPAQ TECHNOLOGY CO., LTD.		
X=±	X.X=±				
ANGLES=±	HOLEDIA=±	THIS DRAWINGS AND SPECIFICATIONS ARE THE PROPERTY OF INPAQ TECHNOLOGY CO.,LTD.AND SHALL NOT BE REPRODUCED OR USED AS THE BASIS FOR THE MANUFACTURE OR SALE OF APPARATUS OR DEVICES WITHOUT PERMISSION			
SCALE : -----	UNIT : mm	DOCUMENT NO. ENS000061960			
DRAWN BY : 彭少君	CHECKED BY : 黃月碧			SPEC REV. A5	
DESIGNED BY : 彭少君	APPROVED BY : 謝立庭				
TITLE : VGAP-CLB-AS-A1 Specification		PAGE 8 OF 9			

(3) Operating temperature range

Operating temperature range : -40 ~ +125°C.

9. Recommended reflow soldering :

Reference : J-STD-020C

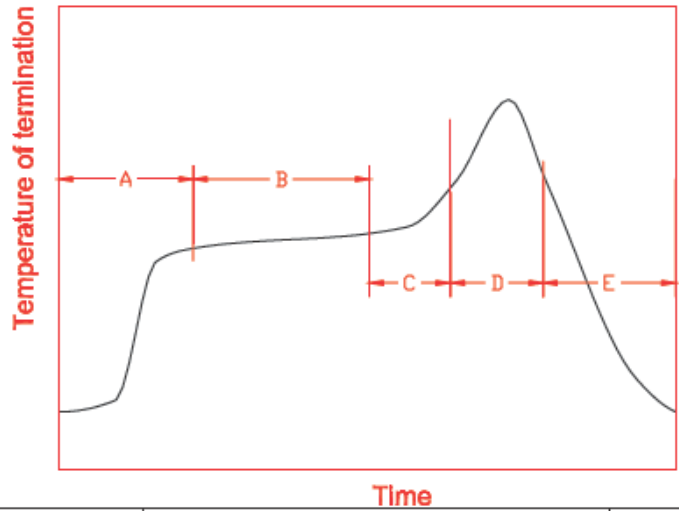

		Time	
A	1 st rising temperature	The normal to Preheating temperature	30s to 60s
B	Preheating	140°C to 160°C	60s to 120s
C	2 nd rising temperature	Preheating to 200°C	20s to 40s
D	Main heating	if 220°C	50s~60s
		if 230°C	40s~50s
		if 240°C	30s~40s
		if 250°C	20s~40s
		if 260°C	20s~40s
E	Regular cooling	200°C to 100°C	1°C/s ~ 4°C/s

(1) Soldering gun procedure

Note the follows, in case of using solder gun for replacement.

- (a) The tip temperature must be less than 350°C for the period within 3 seconds by using soldering gun under 30 W.
- (b) The soldering gun tip shall not touch this product directly.

(2) Soldering volume

Note that excess of soldering volume will easily get crack the body of this product.

UNLESS OTHER SPECIFIED TOLERANCES ON : X=± X.X=± X.XX=			INPAQ TECHNOLOGY CO., LTD.	
ANGLES=± HOLEDIA=±				
SCALE : -----	UNIT : mm	THIS DRAWINGS AND SPECIFICATIONS ARE THE PROPERTY OF INPAQ TECHNOLOGY CO.,LTD.AND SHALL NOT BE REPRODUCED OR USED AS THE BASIS FOR THE MANUFACTURE OR SALE OF APPARATUS OR DEVICES WITHOUT PERMISSION		
DRAWN BY : 彭少君	CHECKED BY : 黃月碧			
DESIGNED BY : 彭少君	APPROVED BY : 謝立庭			
TITLE : VGAP-CLB-AS-A1 Specification		DOCUMENT NO.	ENS000061960	SPEC REV. A5