

2JP0524P

CELLULAR / LTE Rigid Fiberglass

Key Features

CELLULAR / LTE

- 698-960 MHz
- 1710-2170 MHz
- 2500-2700 MHz

Self-Adhesive

High Performance

Ground Plane Independent

Dimensions 126 x 13.6 x 0.8 mm

Customizable Cable and Connector



1. Antenna and electrical specifications

Parameters	CELLULAR / LTE Antenna		
Standards	2G,3G and 4G		
Band (MHz)	700/850/900	1700/1800/1900/2100	2600
Frequency (MHz)	698-960	1710-2170	2500-2700
Return Loss (dB)	~-11.3	~-12.8	~-15.1
VSWR	~1.9:1	~1.6:1	~1.4:1
Efficiency (%)	~50	~53	~60
Peak Gain (dBi)	~0.8	~2.2	~2.0
Average Gain (dB)	~-3.0	~-2.8	~-2.2
Impedance (Ohm)	50		
Polarisation	Linear		
Radiation Pattern	Omni-Directional		
Max. Input Power (W)	25		
Connector Type	U.FL Standard (Other Connectors Available)		
Cable Length	150mm Standard (Any Cable Length Available)		
Cable Type	1.37mm Mini-Coax Standard (Other Cables Available)		

Antenna Measurement Conditions:

Mounted on 30 x 30 x 0.25 cm ABS Plate

150 mm of 1.37 mm Mini-Coax Cable

Measured in Certified CTIA 3D Anechoic Chamber

2. Mechanical and environmental specifications

Specifications	2JP0524P
Mounting Type	Adhesive Mount
Dimensions (mm)	126 x 13.6 x 0.8
Adhesive Type	3M 467
Material	Rigid Fiberglass
Operating Temperature (C)	-40 to +85
Storage Temperature (C)	-40 to +85
Substance Compliance	RoHS

3. Antenna parameters



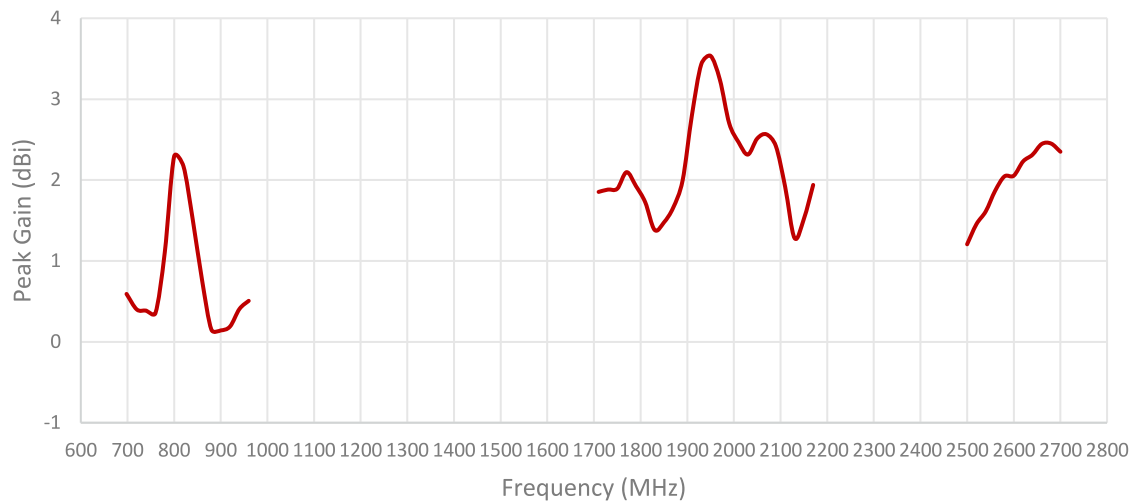
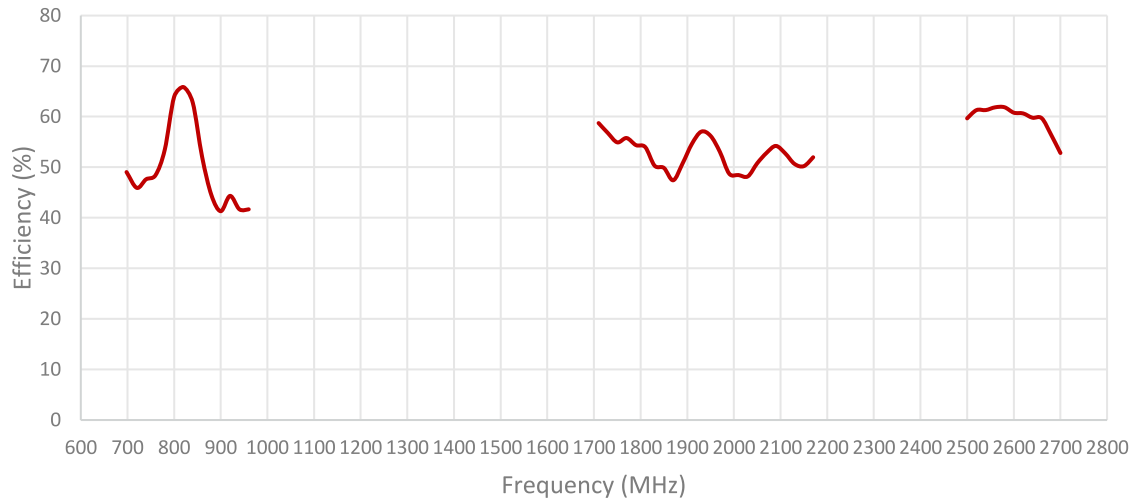

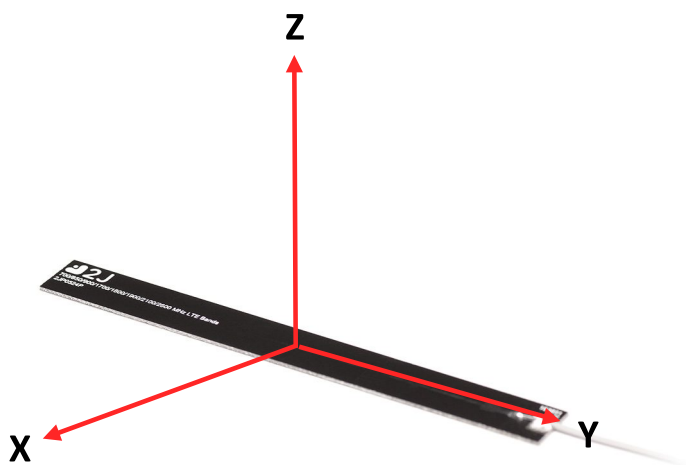
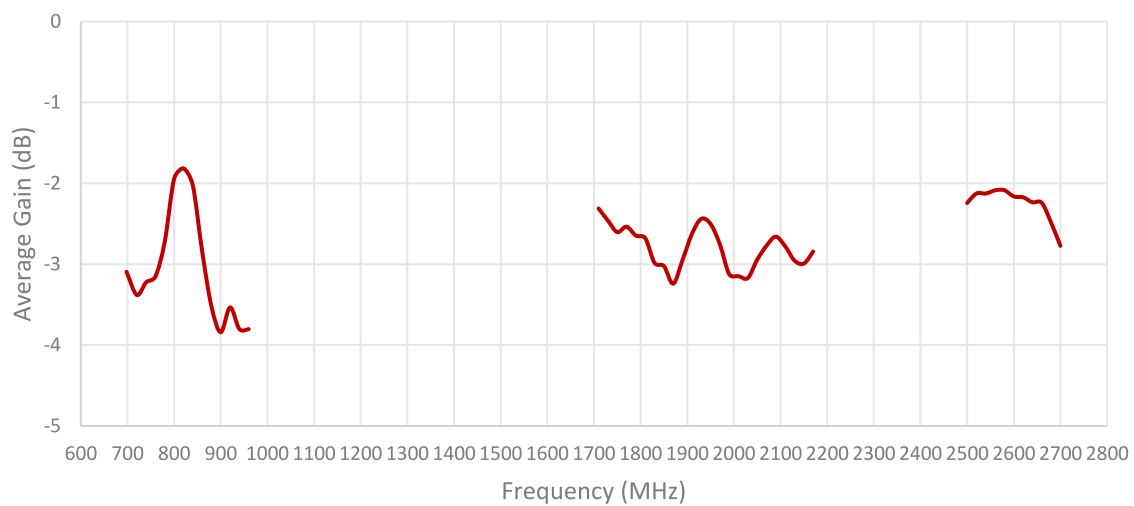

Radiation pattern reference

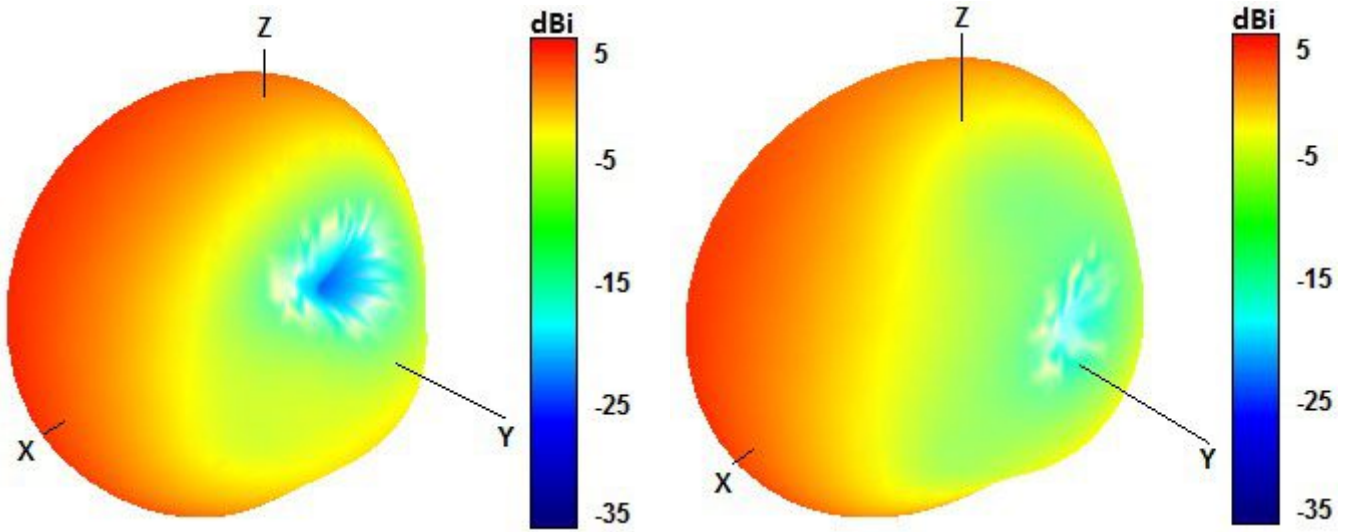

750 and 850 MHz Radiation pattern

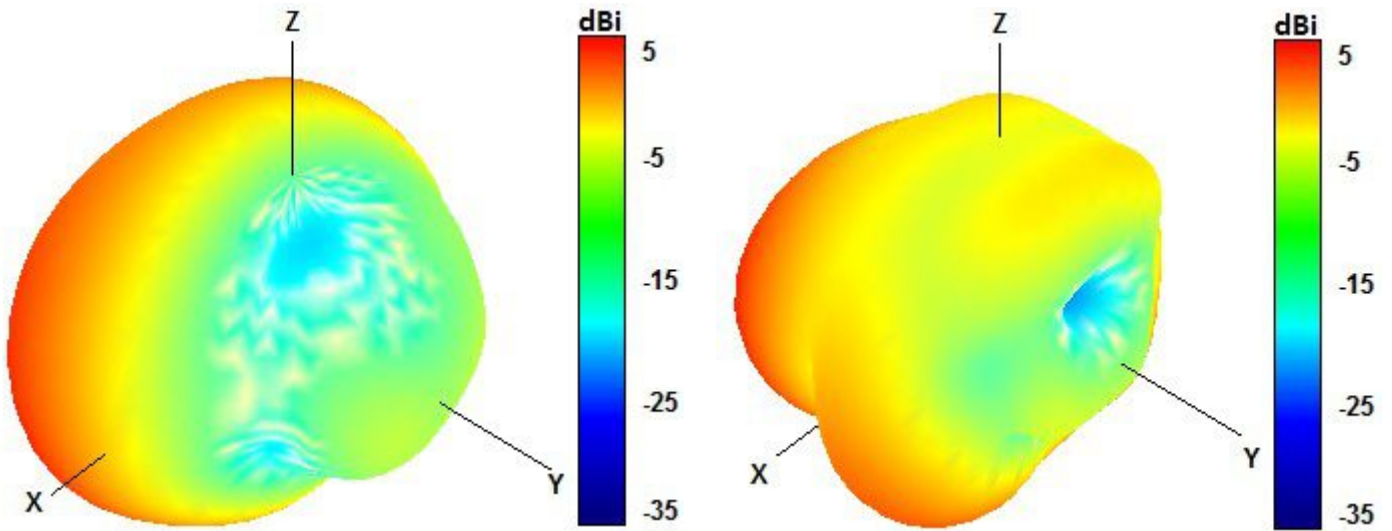

940 and 1750 MHz Radiation pattern

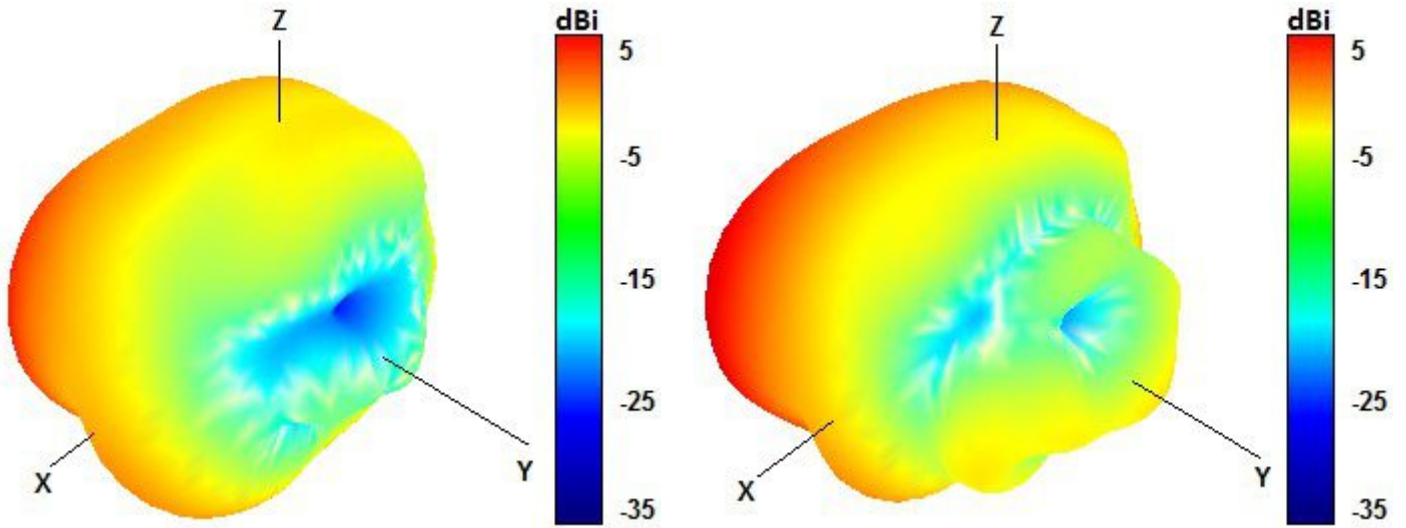

1850 and 1950 MHz Radiation pattern

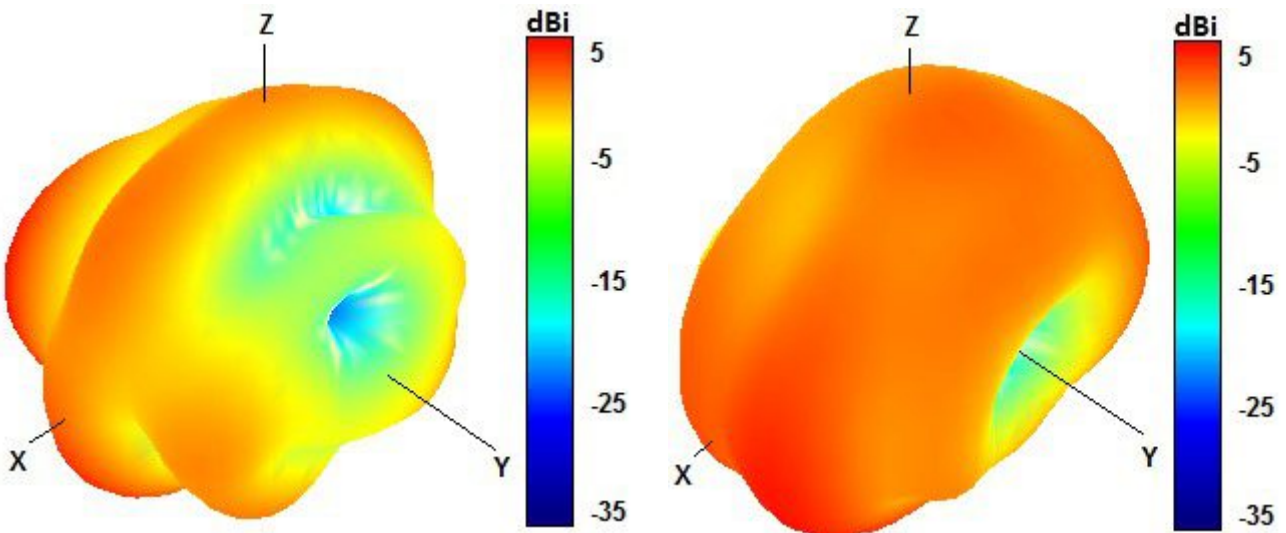

2100 and 2600 MHz Radiation pattern

4. Antenna drawings

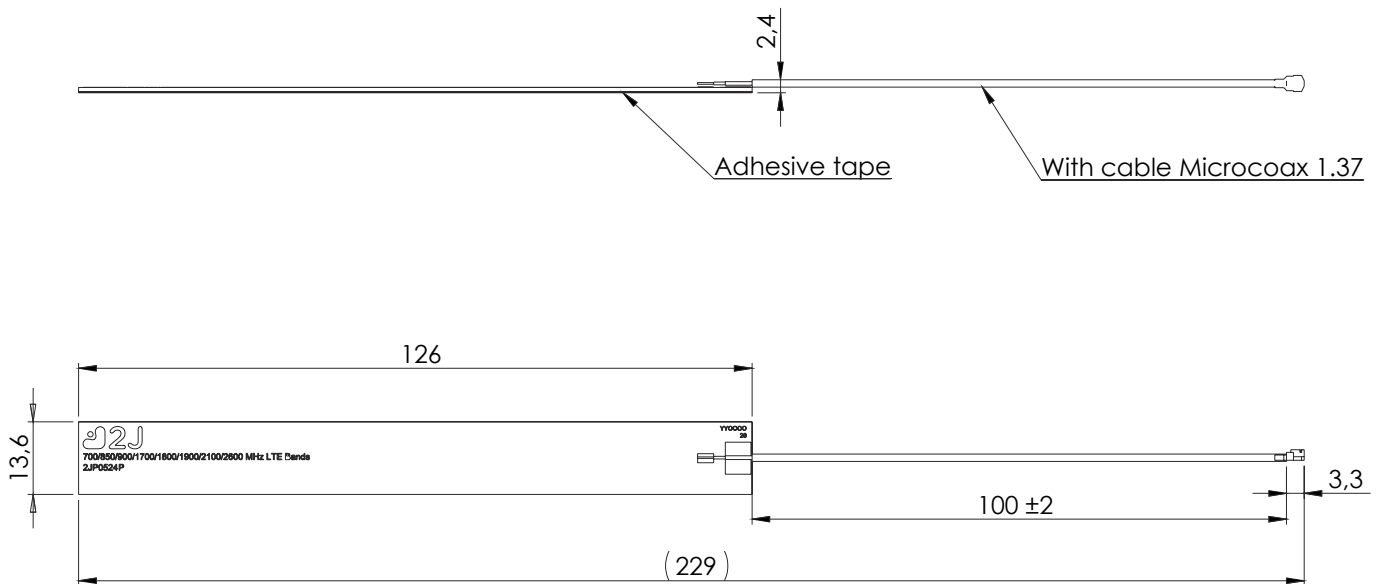

5. Antenna Images

