

FIBRE WASHER

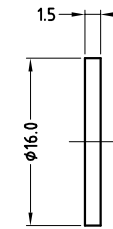

NUT OPTIONS

PLASTIC NUT

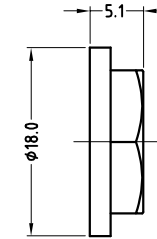

METAL NUT

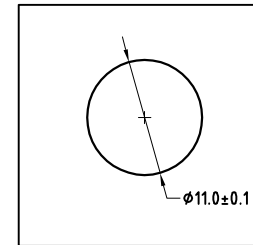
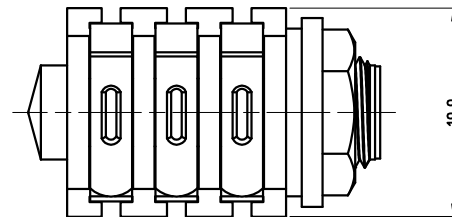
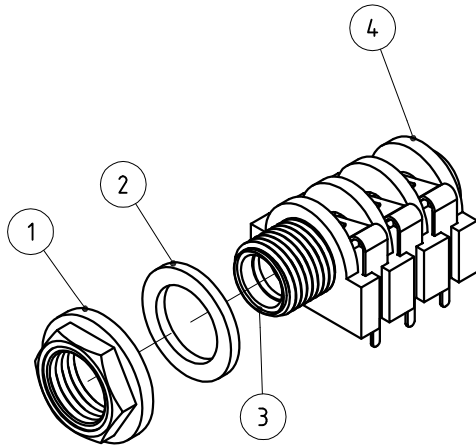
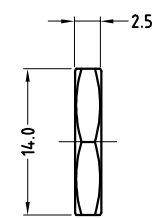

PANEL CUTOUT

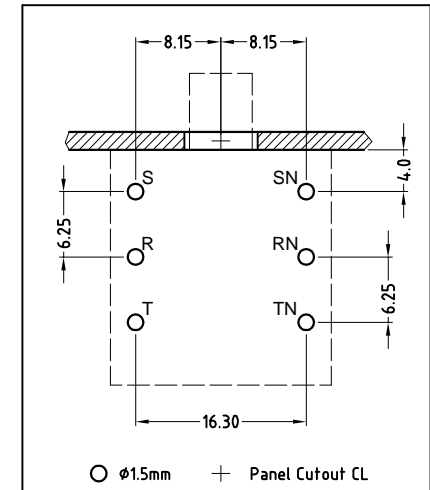

PCB LAYOUT

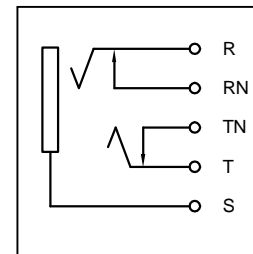

SCHEMATIC

ITEM	DESCRIPTION
1	METAL/PLASTIC NUT
2	FIBRE WASHER
3	METAL TUBE INSERT
4	CONNECTOR ASSEMBLY

PART No.	CATALOG No.	DESCRIPTION
55010099-000	ACJS-MH	METAL NUT
55010099-001	ACJS-PH	PLASTIC NUT

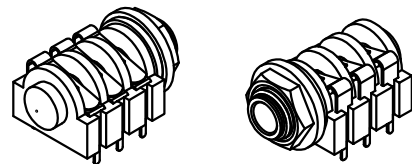

ISO VIEW

UNLESS OTHERWISE SPECIFIED TOLERANCE TO BE		THIS DOCUMENT IS THE PROPERTY OF AMPHENOL AUSTRALIA PTY. LTD.. NO PART THEREOF MAY BE REPRODUCED AND USED WITHOUT THE PRIOR WRITTEN CONSENT OF THE OWNER			
LINEAR	ANGULAR	CAD FILE:	DRN:	L.V	DATE: 17-10-01
X ± 0.5	X° ± 1°	55010099000111	CKD:	M.N.H	DATE: 13-01-06
X.X ± 0.1	X°X' ± 30'	MATL: REFER TO COMPONENT	APP'D:	P.M	DATE: 13-01-06
X.XX ± 0.05	X°X'X" ± 15"	DO NOT SCALE	FINISH: REFER TO COMPONENT		
BREAK ALL SHARP EDGES AND REMOVE ALL BURRS		DIMENSIONS IN MILLIMETRES			
THIRD ANGLE PROJECTION		SCALE:	2:1 UOS	PART No:	REFER TO TABLE

1	CHANGE DRAWING NUMBER & PART VARIATION NUMBER	L.V	07-07-04	8293
0	FIRST ISSUE	L.V	17-10-01	----
REV.	CHANGE DETAILS	BY	DATE	CHG/No
TITLE: 1/4" STEREO JACK PCB LUG CUSTOMER DRAWING		Amphenol		
DRAWING NO. 55010099-000-1		SHEET 1 OF 1		