

REVISIONS					
REV	ECO	DESCRIPTION	DATE	BY	APPR
A3		RELEASE NEW DWG FORMAT	18/JUN/13	DRP	

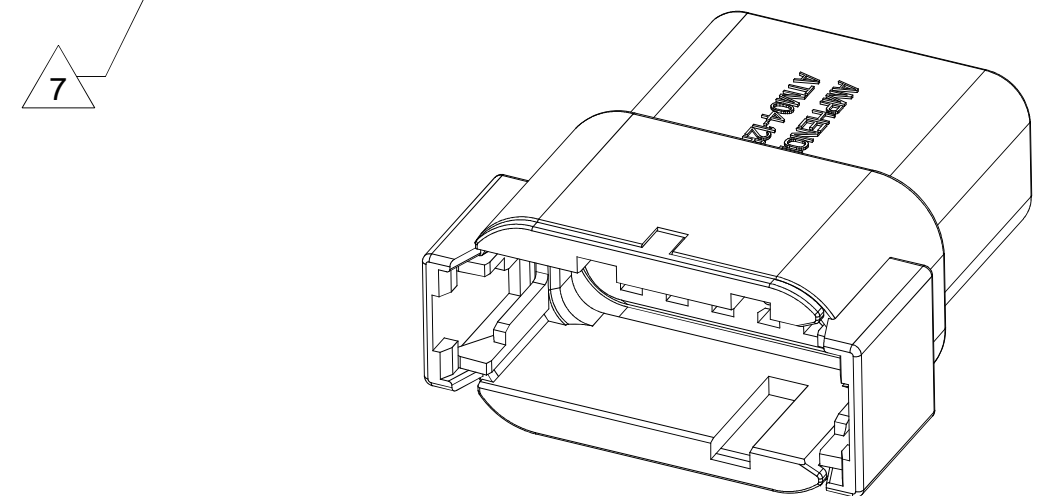

1 KEYWAY (3) PLACES

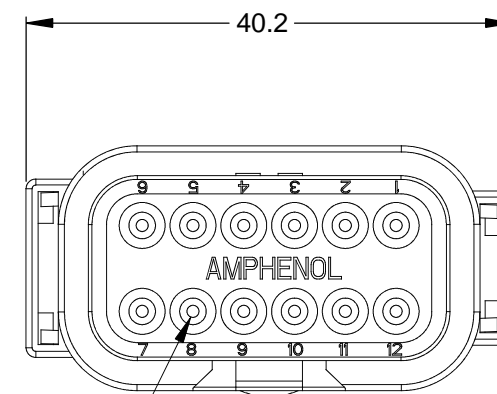
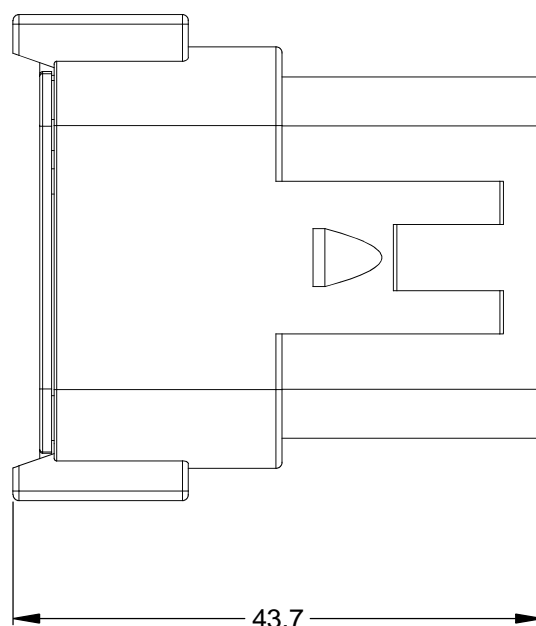
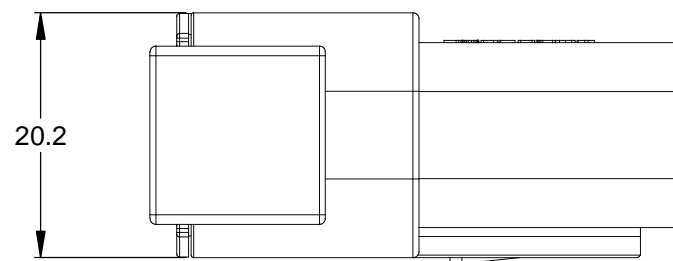
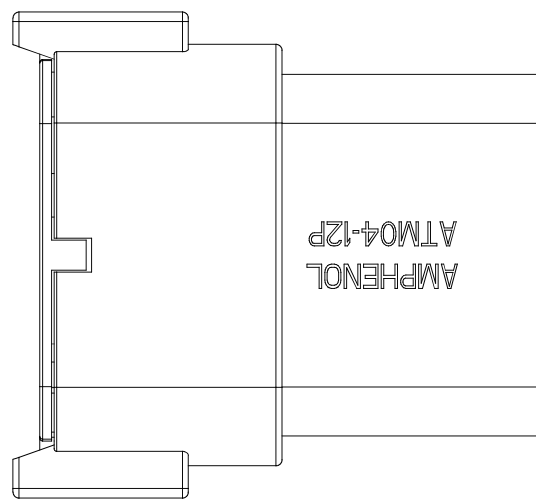
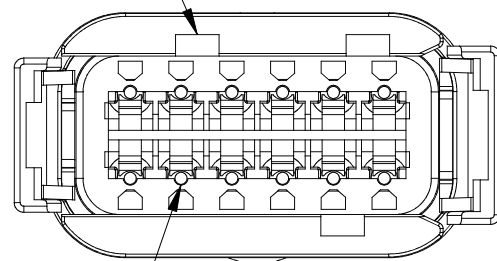

REQUIRES CONTACT RETENTION WEDGE AWM-12P

NOTES: UNLESS OTHERWISE SPECIFIED

1 SEE SHEET 2 FOR KEY ARRANGEMENTS AND COLORS.

2. MATERIAL:  
HOUSING: THERMOPLASTIC  
SEAL: SILICONE RUBBER

3. MODIFICATIONS: N/A

4. SPECIFICATIONS:  
4.1 CURRENT RATING: 7.5 AMPS  
4.2 OPERATING TEMPERATURE: -55°C TO +125°C.  
4.3 DIELECTRIC WITHSTANDING VOLTAGE: LESS THAN 2 MILLIAMPS CURRENT LEAKAGE @ 1500 VOLTS AC.  
4.4 INSULATION RESISTANCE: 1000 MEGOHMS MIN @ 25°C.  
4.5 MOISTURE RESISTANCE: IP67 ( MATED CONDITION )  
4.6 MATING CYCLE DURABILITY: 100 CYCLES  
4.7 RoHS COMPLIANT

5. MATING PART: ATM06-12SX\* PLUG.  
( X = A,B,C,D KEYS; \* = MODIFICATIONS AND COLORS )

6. ALL DIMENSIONS ARE FOR REFERENCE USE ONLY.

7 CONTACT SIZE AND REAR SEAL WIRE RANGE:

CONTACT SIZE	MIN. INSUL O.D.	MAX. INSUL O.D.	TYPICAL WIRE RANGE
20	1.35 mm (.053 in)	3.05 mm (.120 in)	16 - 22 AWG

QUANTITY	SEE SHEET 2 PART NUMBER	DESCRIPTION	ITEM
<b>MATERIALS LIST</b>			
UNLESS OTHERWISE SPECIFIED 1) All dimensions are in metric(mm). 2) Tolerances are as follows: 1 PL DEC ±0.30 2 PL DEC ±0.15 3 PL DEC ±0.08 Fractions ±1/64 Angles ±1° 3) Note reference = X		SIGNATURES DRAWN: D.PARKS CHECKED: ENGINEER: APPROVAL:	DATE 18/JUN/13
MATERIAL SPECIFICATIONS:		<p style="text-align: center;"><b>Amphenol</b></p> <p style="text-align: center;">Sine Systems - www.amphenol-sine.com 44724 Morley Drive Clinton Township, MI 48036</p> <p style="text-align: center;"><b>RECEPTACLE, KEYED, 12 PIN, ATM SERIES</b></p>	
PROCESS SPECIFICATIONS:			
NEXT ASSY:	CUSTOMER:	THIS DRAWING IS SUPPLIED FOR INFORMATION ONLY. DESIGN FEATURES, SPECIFICATIONS AND PERFORMANCE DATA SHOWN HEREON ARE THE PROPERTY OF THE AMPHENOL CORPORATION. NO RIGHTS OF REPRODUCTION ARE IMPLIED. ALL DIMENSIONS ARE SUBJECT TO NORMAL MANUFACTURING VARIATIONS.	
SIZE		TYPE	DWG NO.
B		C-	ATM04-12PX-XXX
SCALE: NONE		REVISION	A3
SHEET 1		OF 2	

TITLE: RECEPTACLE, KEYED, 12 PIN, ATM SERIES  
DWG NO.: ATM04-12PX-XXX  
REV: A3  
SH: 1  
OF: 2

REVISIONS					
REV	ECO	DESCRIPTION	DATE	BY	APPR

P/N ATM04-12PA  
KEY-A CONFIGURATION  
STANDARD COLOR: GREY

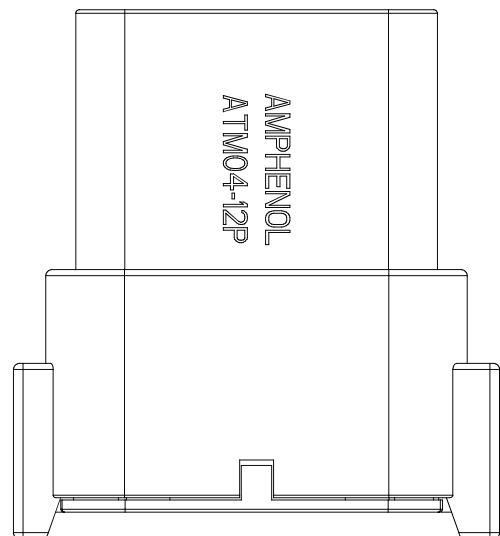

KEYWAY (3) PLACES

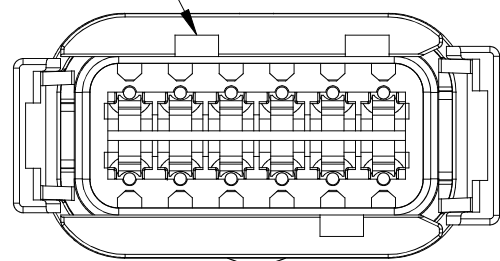

KEY-A CONFIGURATION	
COLOR	PART NUMBER
<b>* GREY</b>	<b>ATM04-12PA</b>
BLACK	ATM04-12PA-BLK
GREEN	ATM04-12PA-GRN
BROWN	ATM04-12PA-BRN

P/N ATM04-12PB  
KEY-B CONFIGURATION  
STANDARD COLOR: BLACK

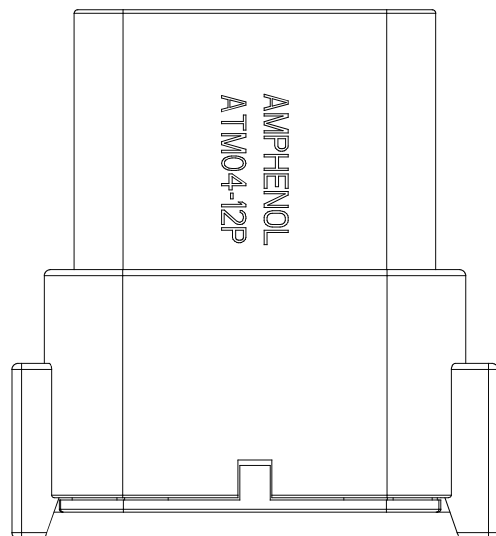

KEYWAY (3) PLACES

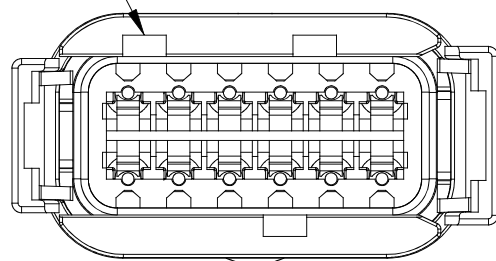

KEY-B CONFIGURATION	
COLOR	PART NUMBER
GREY	ATM04-12PB-GRY
<b>* BLACK</b>	<b>ATM04-12PB</b>
GREEN	ATM04-12PB-GRN
BROWN	ATM04-12PB-BRN

P/N ATM04-12PC  
KEY-C CONFIGURATION  
STANDARD COLOR: GREEN

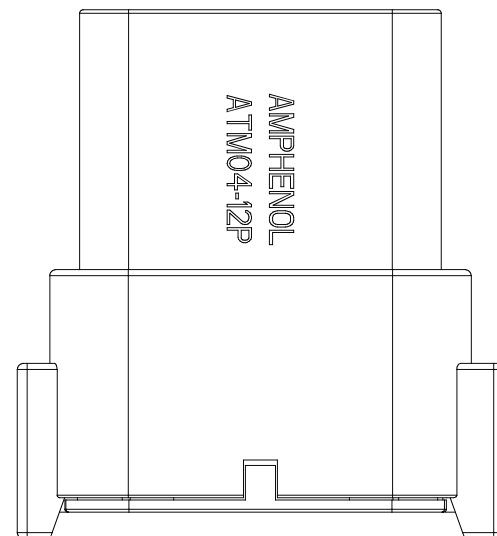

KEYWAY (3) PLACES

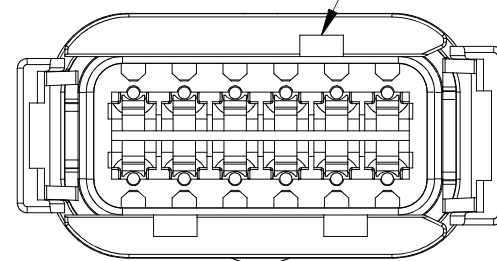

KEY-C CONFIGURATION	
COLOR	PART NUMBER
GREY	ATM04-12PC-GRY
BLACK	ATM04-12PC-BLK
<b>* GREEN</b>	<b>ATM04-12PC</b>
BROWN	ATM04-12PC-BRN

P/N ATM04-12PD  
KEY-D CONFIGURATION  
STANDARD COLOR: BROWN

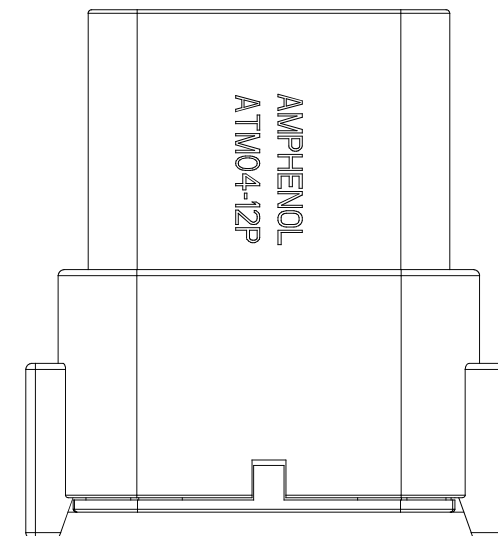

KEYWAY (3) PLACES

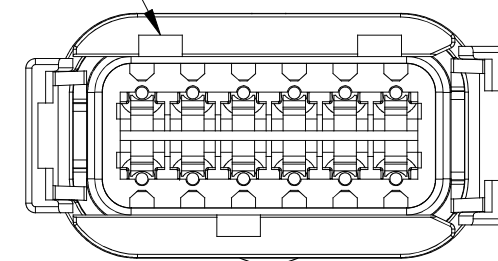

KEY-D CONFIGURATION	
COLOR	PART NUMBER
GREY	ATM04-12PD-GRY
BLACK	ATM04-12PD-BLK
GREEN	ATM04-12PD-GRN
<b>* BROWN</b>	<b>ATM04-12PD</b>

NOTE:

AN ASTERISKS ( \* ) PLACED BEFORE THE COLOR DENOTES THE STANDARD MOLDED COLOR OF THE CONNECTORS SHOWN ABOVE.

OTHER COLORS SHOWN ARE AVAILABLE VIA SPECIAL ORDER.

TITLE: RECEPTACLE, KEYED, 12 PIN, ATM SERIES  
DWG NO.: ATM04-12PX-XXX  
REV: A3  
SH: 2  
OF: 2

QUANTITY	PART NUMBER	DESCRIPTION	ITEM															
<b>MATERIALS LIST</b>																		
UNLESS OTHERWISE SPECIFIED 1) All dimensions are in metric(mm). 2) Tolerances are as follows: 1 PL DEC ±0.30 2 PL DEC ±0.15 3 PL DEC ±0.08 3) Note reference =		<table border="1"> <tr> <th>SIGNATURES</th> <th>DATE</th> </tr> <tr> <td>D.PARKS</td> <td>18/JUN/13</td> </tr> <tr> <td>CHECKED:</td> <td></td> </tr> <tr> <td>ENGINEER:</td> <td></td> </tr> <tr> <td>APPROVAL:</td> <td></td> </tr> <tr> <td>CUSTOMER:</td> <td></td> </tr> </table>		SIGNATURES	DATE	D.PARKS	18/JUN/13	CHECKED:		ENGINEER:		APPROVAL:		CUSTOMER:				
SIGNATURES	DATE																	
D.PARKS	18/JUN/13																	
CHECKED:																		
ENGINEER:																		
APPROVAL:																		
CUSTOMER:																		
MATERIAL SPECIFICATIONS:		<p style="text-align: center;"><b>Amphenol</b></p> <p style="text-align: center;">Sine Systems - www.amphenol-sine.com 44724 Morley Drive Clinton Township, MI 48036</p> <p style="text-align: center;">RECEPTACLE, KEYED, 12 PIN, ATM SERIES</p>																
PROCESS SPECIFICATIONS:																		
NEXT ASSY:		<table border="1"> <tr> <td>THIS DRAWING IS SUPPLIED FOR INFORMATION ONLY. DESIGN FEATURES, SPECIFICATIONS AND PERFORMANCE DATA SHOWN HEREON ARE THE PROPERTY OF THE AMPHENOL CORPORATION. NO RIGHTS OF REPRODUCTION ARE IMPLIED. ALL DIMENSIONS ARE SUBJECT TO NORMAL MANUFACTURING VARIATIONS.</td> <td>SIZE</td> <td>TYPE</td> <td>DWG NO.</td> <td>REVISION</td> </tr> <tr> <td></td> <td><b>B</b></td> <td><b>C-</b></td> <td><b>ATM04-12PX-XXX</b></td> <td><b>A3</b></td> </tr> <tr> <td>SCALE:</td> <td colspan="2">NONE</td> <td>SHEET</td> <td>2 OF 2</td> </tr> </table>		THIS DRAWING IS SUPPLIED FOR INFORMATION ONLY. DESIGN FEATURES, SPECIFICATIONS AND PERFORMANCE DATA SHOWN HEREON ARE THE PROPERTY OF THE AMPHENOL CORPORATION. NO RIGHTS OF REPRODUCTION ARE IMPLIED. ALL DIMENSIONS ARE SUBJECT TO NORMAL MANUFACTURING VARIATIONS.	SIZE	TYPE	DWG NO.	REVISION		<b>B</b>	<b>C-</b>	<b>ATM04-12PX-XXX</b>	<b>A3</b>	SCALE:	NONE		SHEET	2 OF 2
THIS DRAWING IS SUPPLIED FOR INFORMATION ONLY. DESIGN FEATURES, SPECIFICATIONS AND PERFORMANCE DATA SHOWN HEREON ARE THE PROPERTY OF THE AMPHENOL CORPORATION. NO RIGHTS OF REPRODUCTION ARE IMPLIED. ALL DIMENSIONS ARE SUBJECT TO NORMAL MANUFACTURING VARIATIONS.	SIZE	TYPE	DWG NO.	REVISION														
	<b>B</b>	<b>C-</b>	<b>ATM04-12PX-XXX</b>	<b>A3</b>														
SCALE:	NONE		SHEET	2 OF 2														

# A Series™ - Contact Size 20 Options (Works with: ATM, DuraMate and PanelMate Series)

Machined Contacts, Sockets & Pins				
Part Number	Description	Size	AWG	Type
AT60-010-2031	Male Contact - Pin, Gold-plated	20	16-18	Machined
AT62-005-20141	Female Contact - Socket, Gold-plated	20	16-18	Machined
AT60-010-20141	Male Contact - Pin, Nickel-plated	20	16-18	Machined
AT62-005-2031	Female Contact - Socket, Nickel-plated	20	16-18	Machined
AT60-202-2031	Male Contact - Pin, Gold-plated	20	20-22	Machined
AT62-201-2031	Female Contact - Socket, Gold-plated	20	20-22	Machined
AT60-202-20141	Male Contact - Pin, Nickel-plated	20	20-22	Machined
AT62-201-20141	Female Contact - Socket, Nickel-plated	20	20-22	Machined

Tooling - Machined Contacts	
Part Number	Description
AUTK-20	Hand Crimp Tool, Size 20
AUTK-100	Universal Heavy Duty Contact Crimping Tool Kit, Size 12/16/20
CA-5D12	Universal Hand Crimp Tool, Size 12/16/20
CA-5E12	Pneumatic Crimp Tool, Size 12/16/20

Stamped & Formed Contacts, Sockets & Pins				
Part Number	Description	Size	AWG	Type
AT60-20-0144	Male Contact - Pin, Gold-plated	20	16-22	Stamped & Formed
AT62-20-0144	Female Contact - Socket, Gold-plated	20	16-22	Stamped & Formed
AT60-20-0244	Male Contact - Socket, Gold-plated	20	16-22	Stamped & Formed
AT62-20-0244	Female Contact - Socket, Gold-plated	20	16-22	Stamped & Formed
AT60-20-0122	Male Contact - Pin, Nickel-plated	20	16-22	Stamped & Formed
AT62-20-0122	Female Contact - Socket, Nickel-plated	20	16-22	Stamped & Formed
AT60-20-0222	Male Contact - Socket, Nickel-plated	20	16-22	Stamped & Formed
AT62-20-0222	Female Contact - Socket, Nickel-plated	20	16-22	Stamped & Formed
AT60-20-0277	Male Contact - Socket, Tin-plated	20	16-22	Stamped & Formed
AT62-20-0277	Female Contact - Socket, Tin-plated	20	16-22	Stamped & Formed
AT60-20-0422	Male Contact - Socket, Nickel-plated	20	20-22	Stamped & Formed
AT62-20-0444	Female Contact - Socket, Gold-plated	20	20-22	Stamped & Formed

Tooling - Stamped & Formed Contacts	
MF3-3974	Crimp Die - Size 20
MF3-3976	Crimp Die - Size 20 (20-22AWG -04XX Series)
MF3-3978	Crimp Die - Size 20 (20-22AWG -02XX Series)
ATT-20-00	Hand Crimp Tool - Size 20 (20AWG)

Contact Removal Tools (For both Machined or Stamped & Formed Contacts)	
Part Number	Description
ATRT-100	Contact and Wedgelock Extraction Tool
AT11-240-2005	Contact Removal Tool, Plastic, Size 20

Sealing Plugs (For both Machined or Stamped & Formed Contacts)	
Part Number	Description
AT13-204-2005	Sealing Plug, Size 20, White
AT13-204-2005-SR	Sealing Plug, Size 20, SR01 Series, Black
ATM13-217-2005	Locking Sealing Plug, Size 20, Grey
ATM13-217-2005-SR	Locking Sealing Plug, Size 20, SR01 Series, Blue