

CONFIDENTIAL

VERTRAULICH

Alle Rechte bei Marquardt, auch fuer den Fall von Schutzrechtsanmeldungen. Jede Veruegungsbefugnis, wie Kopier- und Weitergaberecht, bei uns.

THIS DRAWING IS THE EXCLUSIVE PROPERTY OF MARQUARDT. WITHOUT THEIR CONSENT IT MAY NOT BE REPRODUCED OR GIVEN TO THIRD PARTIES.

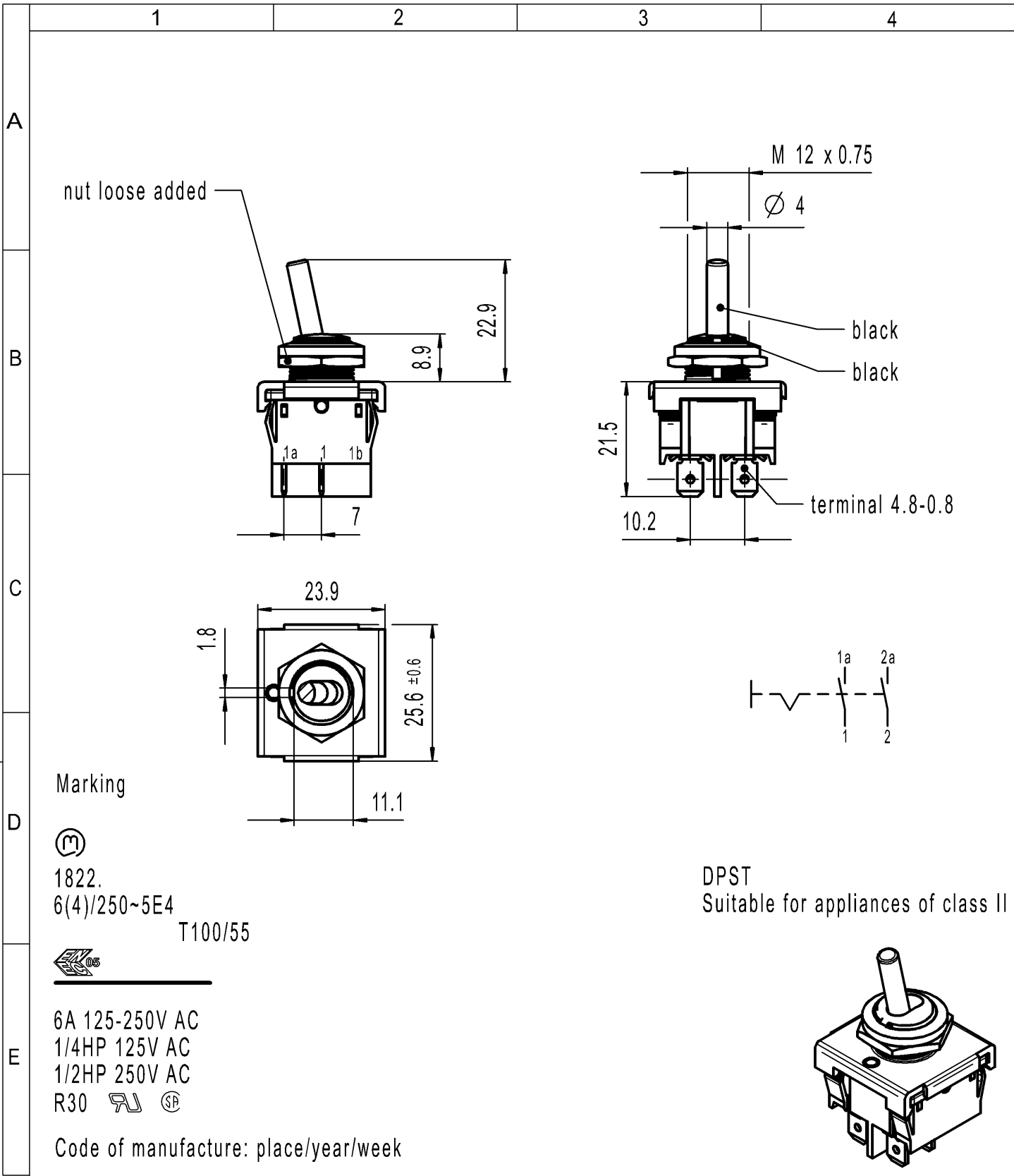



Marking



 1822.
 6(4)/250~5E4
 T100/55



DPST
 Suitable for appliances of class II

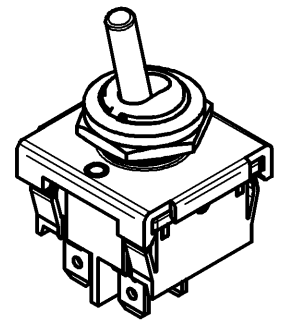

6A 125-250V AC
 1/4HP 125V AC
 1/2HP 250V AC
 R30  

Code of manufacture: place/year/week

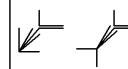

| | | | | | | | | | |
|-----------------------------------|--|-------------------|--|--------------|--------------------------------------|---------------|---|---|-----------|
| - | | - | | - | | 1822.1101-XX | | | |
| Figure | | Type | | Customer No. | | Art.No.-PI | | | |
| General tolerances | | | | Sheet 01 | | | Ident. K | | |
| All dimensions are in millimetres | Shape and location  | Angle ± 2 ° | Edge tolerance  | Length | Radii | Format DIN A4 | Projection  | | |
| | | | | 0-6 | ± 0.2 | | | ± | Scale 1:1 |
| | | | | >6-15 | ± 0.4 | | | ± | |
| | | | | >15-30 | ± 0.4 | | | ± | |
| | | | | >30-70 | ± | | | ± | |
| >70-120 | ± | ± | | | | | | | |
| >120 | ± | ± | | | | | | | |
| f | 131663 | 2020-09-08 | PANDHAREA | | System NX V11.0 | | Document number 18221101 | | |
| e | 64505 | 2010-01-27 | MUT | | Replacement of Zg.gl.Nr.v.02.08.2000 | | | | |
| d | 56042 | 2008-01-16 | VOR | | MARQUARDT | | Index f | | |
| c | 29870 | 2000-06-19 | BMI | | | | | | |
| Index | MEC-No. | Date (YYYY-MM-DD) | Edited by | | Appliance Switch | | | | |