8V INPUT LOW SUPPLY CURRENT VOLTAGE REGULATOR

NO.EA-038-130422

OUTLINE

The RN5RT Series are CMOS-based voltage regulator ICs with high output voltage accuracy and low supply current developed. Each of these voltage regulator ICs consists of a voltage reference unit, an error amplifier, output voltage setting resistors and a current limit circuit. The output voltage of these ICs is fixed with high accuracy.

The built-in Driver Transistor of low ON Resistance permits developing of low dropout CMOS type regulator as RN5RT Series. Even if V_{OUT} is shorted to GND, the current limit circuit protects the ICs from destruction. Furthermore, these ICs have a chip enable function, so that the supply current on standby can be minimized.

Since the package for these ICs is the SOT-23-5 (Mini-mold) package, high density mounting of the ICs on boards is possible.

FEATURES

- Supply Current Typ. 4 μ A (except I_{CEL})
- Standby Current Typ. 0.1 μ A
- Dropout Voltage Typ. 0.3V ($I_{OUT}=60\text{mA}$, RN5RT30A)
- Temperature-Drift Coefficient of Output Voltage Typ. $\pm 100\text{ppm}/^\circ\text{C}$
- Line Regulation. Typ. 0.15%/V
- Input Voltage Range Max. 8.0V
- Output Voltage Range..... 2.0V to 6.0V (0.1V steps)
- Output Voltage Accuracy..... $\pm 2.0\%$
- Built-in Fold Back Protection Circuit Typ. 30mA (Current at short mode)
- Package SOT-23-5

APPLICATION

- Power source for battery-powered equipment.
- Power source for cellular phones, cameras, VCRs, camcorders, hand-held audio instruments and hand-held communication equipment.
- Power source for domestic appliances.

BLOCK DIAGRAM

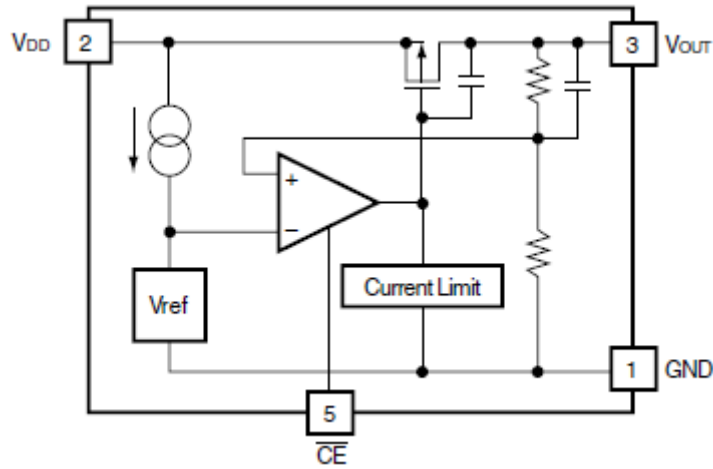

SELECTION GUIDE

The output voltage for the ICs can be selected at the user's request.

Product Name	Package	Quantity per Reel	Pb Free	Halogen Free
RN5RTxxAA-TR-FE	SOT-23-5	3,000 pcs	Yes	Yes
xx: The output voltage can be designated in the range from 1.2V (12) to 6.0V (60) in 0.1V steps.				

PIN CONFIGURATION

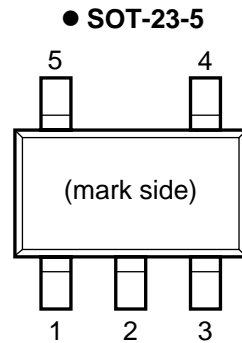

PIN DESCRIPTION

● SOT-23-5

Pin No	Symbol	Pin Description
1	GND	Ground Pin
2	V _{DD}	Input Pin
3	V _{OUT}	Output Pin
4	NC	No Connection
5	$\overline{\text{CE}}$	Chip Enable Pin

ABSOLUTE MAXIMUM RATINGS

Symbol	Item	Rating	Unit
V_{IN}	Input Voltage	9	V
V_{CE}	Input Voltage (\overline{CE})	-0.3 to $V_{IN}+0.3$	V
V_{OUT}	Output Voltage	-0.3 to $V_{IN}+0.3$	V
I_{OUT}	Output Current	150	mA
P_D	Power Dissipation* (SOT-23-5)	420	mW
T_{opt}	Operating Temperature Range	-40 to 85	°C
T_{stg}	Storage Temperature Range	-55 to 125	°C
T_{solder}	Lead Temperature (Soldering)	260°C , 10s	

*) For Power Dissipation, please refer to PACKAGE INFORMATION.

ABSOLUTE MAXIMUM RATINGS

Electronic and mechanical stress momentarily exceeded absolute maximum ratings may cause the permanent damages and may degrade the life time and safety for both device and system using the device in the field.

The functional operation at or over these absolute maximum ratings is not assured.

RECOMMENDED OPERATING CONDITIONS (ELECTRICAL CHARACTERISTICS)

All of electronic equipment should be designed that the mounted semiconductor devices operate within the recommended operating conditions. The semiconductor devices cannot operate normally over the recommended operating conditions, even if when they are used over such conditions by momentary electronic noise or surge. And the semiconductor devices may receive serious damage when they continue to operate over the recommended operating conditions.

ELECTRICAL CHARACTERISTICS

• RN5RT30A

T_{opt}=25°C

Symbol	Item	Conditions	Min.	Typ.	Max.	Unit
V _{OUT}	Output Voltage	V _{IN} =4.0V, I _{OUT} =10mA	2.940	3.000	3.060	V
I _{OUT}	Output Current	V _{IN} =4.0V	40	60		mA
$\frac{\Delta V_{OUT}}{\Delta I_{OUT}}$	Load Regulation	V _{IN} =4.0V 1mA ≤ I _{OUT} ≤ 60mA		40	80	mV
V _{DIF}	Dropout Voltage	I _{OUT} =60mA		0.3	0.5	V
I _{SS}	Supply Current	V _{IN} =4.0V (except I _{CEL})		4.0	10	μA
I _{standby}	Supply Current (Standby)	V _{IN} =V _{CE} =4.0V		0.1	1.0	μA
$\frac{\Delta V_{OUT}}{\Delta V_{IN}}$	Line Regulation	I _{OUT} =30mA V _{OUT} +0.5V ≤ V _{IN} ≤ 8.0V	0.00	0.15	0.30	%/V
V _{IN}	Input Voltage				8	V
$\frac{\Delta V_{OUT}}{\Delta T_{opt}}$	Output Voltage Temperature Coefficient	I _{OUT} =10mA -40°C ≤ T _{opt} ≤ 85°C		±100		ppm/°C
I _{lim}	Short Current Limit	V _{OUT} =0V		30		mA
V _{CEH}	\overline{CE} Input Voltage "H"		1.5			V
V _{CEL}	\overline{CE} Input Voltage "L"				0.25	V
I _{CEH}	\overline{CE} Input Current "H"	V _{CE} =V _{IN}		0.0	0.1	μA
I _{CEL}	\overline{CE} Input Current "L"	V _{CE} =0V	-4.0	-2.0	-0.1	μA

• RN5RT40A

Topt=25°C

Symbol	Item	Conditions	Min.	Typ.	Max.	Unit
V _{OUT}	Output Voltage	V _{IN} =5.0V, I _{OUT} =10mA	3.920	4.000	4.080	V
I _{OUT}	Output Current	V _{IN} =5.0V	50	80		mA
$\frac{\Delta V_{OUT}}{\Delta I_{OUT}}$	Load Regulation	V _{IN} =5.0V 1mA≤I _{OUT} ≤80mA		40	80	mV
V _{DIF}	Dropout Voltage	I _{OUT} =80mA		0.3	0.5	V
I _{SS}	Supply Current	V _{IN} =5.0V (except I _{CEL})		4	10	μA
I _{standby}	Supply Current (Standby)	V _{IN} =V _{CE} =5.0V		0.1	1.0	μA
$\frac{\Delta V_{OUT}}{\Delta V_{IN}}$	Line Regulation	I _{OUT} =30mA V _{OUT} +0.5V≤V _{IN} ≤8.0V		0.15	0.30	%/V
V _{IN}	Input Voltage				8	V
$\frac{\Delta V_{OUT}}{\Delta T_{opt}}$	Output Voltage Temperature Coefficient	I _{OUT} =10mA -40°C≤T _{opt} ≤85°C		±100		ppm/°C
I _{lim}	Short Current Limit	V _{OUT} =0V		30		mA
V _{CEH}	\overline{CE} Input Voltage "H"		1.5			V
V _{CEL}	\overline{CE} Input Voltage "L"				0.25	V
I _{CEH}	\overline{CE} Input Current "H"	V _{CE} =V _{IN}		0.0	0.1	μA
I _{CEL}	\overline{CE} Input Current "L"	V _{CE} =0V	-4.0	-2.0	-0.1	μA

• RN5RT50A

Topt=25°C

Symbol	Item	Conditions	Min.	Typ.	Max.	Unit
V _{OUT}	Output Voltage	V _{IN} =6.0V, I _{OUT} =10mA	4.900	5.000	5.100	V
I _{OUT}	Output Current	V _{IN} =6.0V	65	100		mA
$\frac{\Delta V_{OUT}}{\Delta I_{OUT}}$	Load Regulation	V _{IN} =6.0V 1mA≤I _{OUT} ≤100mA		40	80	mV
V _{DIF}	Dropout Voltage	I _{OUT} =100mA		0.3	0.5	V
I _{SS}	Supply Current	V _{IN} =6.0V (except I _{CEL})		4	10	μA
I _{standby}	Supply Current (Standby)	V _{IN} =V _{CE} =6.0V		0.1	1.0	μA
$\frac{\Delta V_{OUT}}{\Delta V_{IN}}$	Line Regulation	I _{OUT} =30mA V _{OUT} +0.5V≤V _{IN} ≤8.0V		0.15	0.30	%/V
V _{IN}	Input Voltage				8	V
$\frac{\Delta V_{OUT}}{\Delta T_{opt}}$	Output Voltage Temperature Coefficient	I _{OUT} =10mA -40°C≤T _{opt} ≤85°C		±100		ppm/°C
I _{lim}	Short Current Limit	V _{OUT} =0V		30		mA
V _{CEH}	\overline{CE} Input Voltage "H"		1.5			V
V _{CEL}	\overline{CE} Input Voltage "L"				0.25	V
I _{CEH}	\overline{CE} Input Current "H"	V _{CE} =V _{IN}		0.0	0.1	μA
I _{CEL}	\overline{CE} Input Current "L"	V _{CE} =0V	-4.0	-2.0	-0.1	μA

ELECTRICAL CHARACTERISTICS BY OUTPUT VOLTAGE

Part Number	Output Voltage			Output Current		Load Regulation			Dropout Voltage			Supply Current				
	V _{OUT} (V)			I _{OUT} (mA)		ΔV _{OUT} /ΔI _{OUT} (mA)			V _{DIF} (V)			I _{SS} (μA)				
	Conditions	Min.	Typ.	Max.	Conditions	Min.	Typ.	Conditions	Typ.	Max.	Conditions	Typ.	Max.	Conditions	Typ.	Max.
RN5RT20A	V _{IN} -V _{OUT} =1.0V I _{OUT} =10mA	1.960	2.000	2.040	V _{IN} -V _{OUT} =1.0V	25	40	V _{IN} -V _{OUT} =1.0V 1mA ≤ I _{OUT} ≤ 40mA	40	80	0.3	0.5	V _{IN} -V _{OUT} =1.0V (except I _{CEL})	4.0	10	
RN5RT21A		2.058	2.100	2.142												
RN5RT22A		2.156	2.200	2.244												
RN5RT23A		2.254	2.300	2.346												
RN5RT24A		2.352	2.400	2.448												
RN5RT25A		2.450	2.500	2.550												
RN5RT26A		2.548	2.600	2.652												
RN5RT27A		2.646	2.700	2.754												
RN5RT28A		2.744	2.800	2.856												
RN5RT29A		2.842	2.900	2.958												
RN5RT30A		2.940	3.000	3.060												
RN5RT31A		3.038	3.100	3.162												
RN5RT32A		3.136	3.200	3.264												
RN5RT33A		3.234	3.300	3.366												
RN5RT34A		3.332	3.400	3.468												
RN5RT35A		3.430	3.500	3.570												
RN5RT36A		3.528	3.600	3.672												
RN5RT37A		3.626	3.700	3.774												
RN5RT38A		3.724	3.800	3.876												
RN5RT39A		3.822	3.900	3.978												
RN5RT40A		3.920	4.000	4.080												
RN5RT41A		4.018	4.100	4.182												
RN5RT42A		4.116	4.200	4.284												
RN5RT43A		4.214	4.300	4.386												
RN5RT44A		4.312	4.400	4.488												
RN5RT45A		4.410	4.500	4.590												
RN5RT46A		4.508	4.600	4.692												
RN5RT47A		4.606	4.700	4.794												
RN5RT48A		4.704	4.800	4.896												
RN5RT49A		4.802	4.900	4.998												
RN5RT50A	4.900	5.000	5.100													
RN5RT51A	4.998	5.100	5.202													
RN5RT52A	5.096	5.200	5.304													
RN5RT53A	5.194	5.300	5.406													
RN5RT54A	5.292	5.400	5.508													
RN5RT55A	5.390	5.500	5.610													
RN5RT56A	5.488	5.600	5.712													
RN5RT57A	5.586	5.700	5.814													
RN5RT58A	5.684	5.800	5.916													
RN5RT59A	5.782	5.900	6.018													
RN5RT60A	5.880	6.000	6.120													

T_{opt}=25°C

Supply Current (Standby)			Line Regulation			Input Voltage	Output Voltage Temperature Coefficient		Short Current Limit		CE Input Voltage		CE Input Current						
											"H"	"L"	"H"			"L"			
Istandby (μA)			ΔV _{OUT} /ΔV _{IN} (%/V)			V _{IN} (V)	ΔV _{OUT} /ΔT (ppm/°C)		I _{lim} (mA)	V _{CEH} (V)	V _{CEL} (V)	I _{CEH} (μA)			I _{CEL} (μA)				
Conditions	Typ.	Max.	Conditions	Typ.	Max.	Max.	Conditions	Typ.	Conditions	Typ.	Min.	Max.	Conditions	Typ.	Max.	Conditions	Min.	Typ.	Max.
V _{IN} -V _{OUT} =1.0V	0.1	1.0	I _{OUT} = 30mA V _{OUT} + 0.5V ≤V _{IN} ≤8V	0.15	0.3	8	I _{OUT} = 10mA -40°C ±100 ≤T _{opt} ≤85°C		V _{OUT} =0V	30	1.5	0.25	V _{CE} = V _{IN}	0	0.1	V _{CE} = 0V	-4.0	-2.0	-0.1

OPERATION

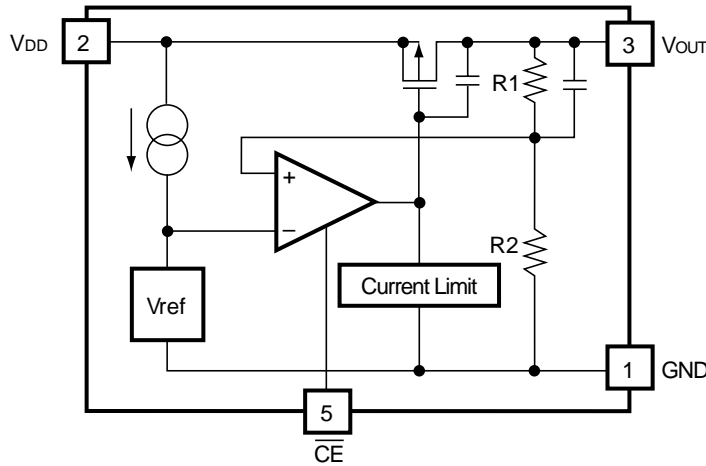

In these ICs, the output voltage V_{OUT} is detected by feed-back registers R1, R2, and the detected output voltage is compared with a reference voltage by the error amplifier, so that a constant voltage is output.

A current limit circuit working for short protection and a chip enable circuit for standby function are included.

TEST CIRCUITS

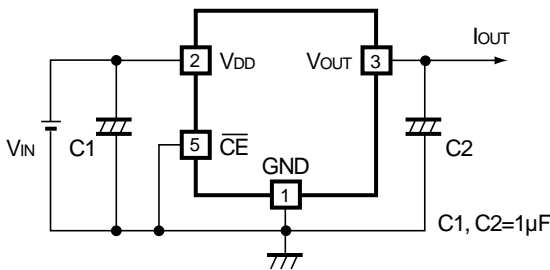

Fig.1 Standard Test Circuit

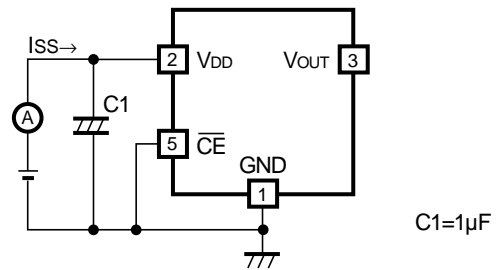

Fig.2 Supply Current Test Circuit

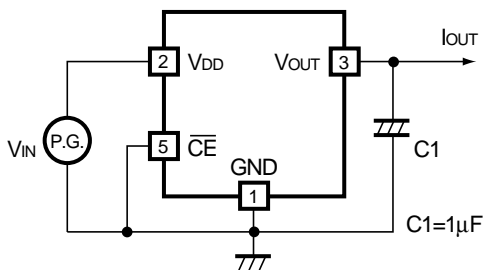
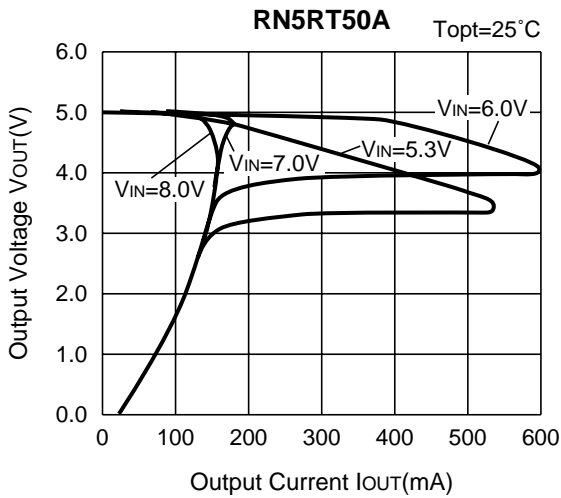
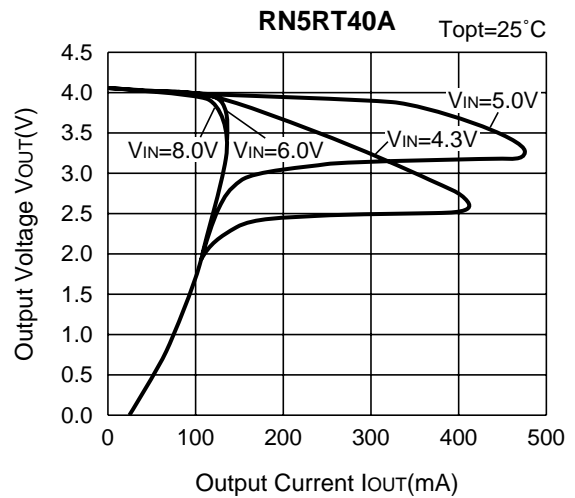
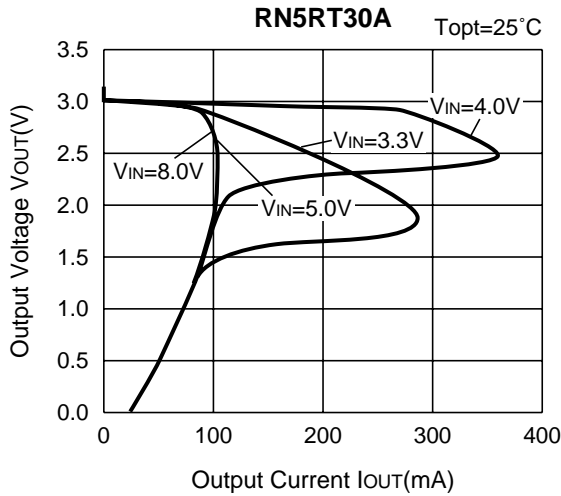

Fig.3 Line Transient Response Test Circuit

TYPICAL CHARACTERISTICS

1) Output Voltage vs. Output Current



2) Output Voltage vs. Input Voltage

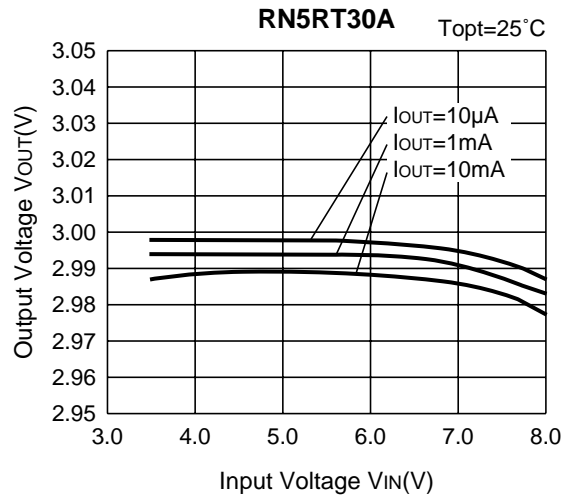
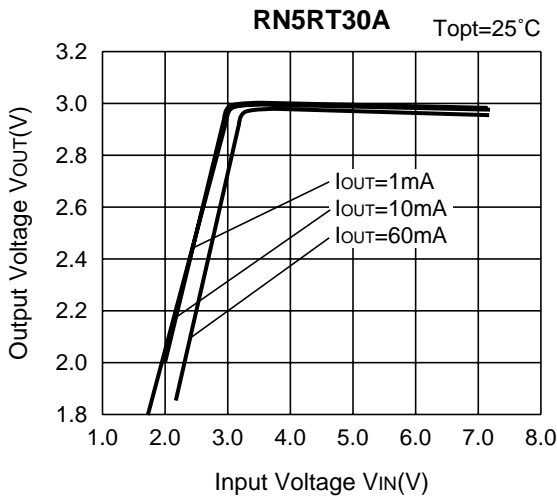

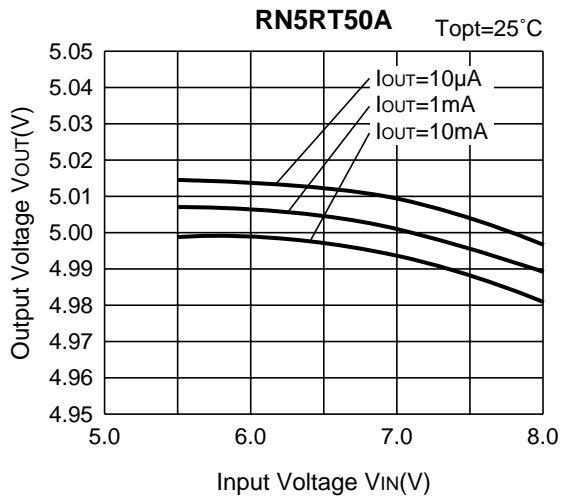
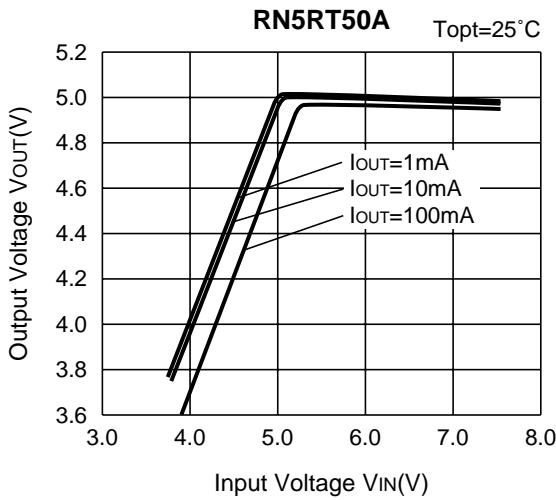
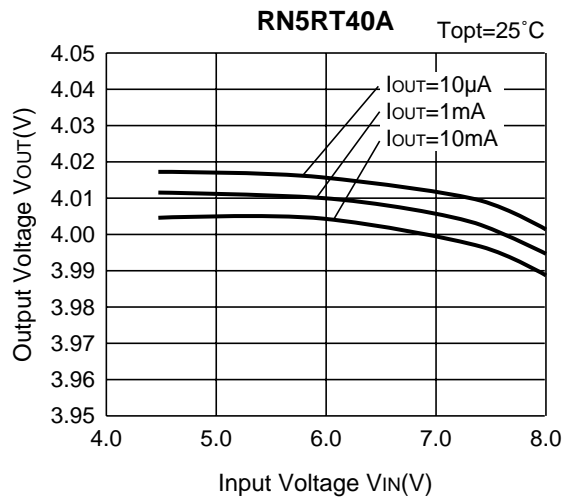
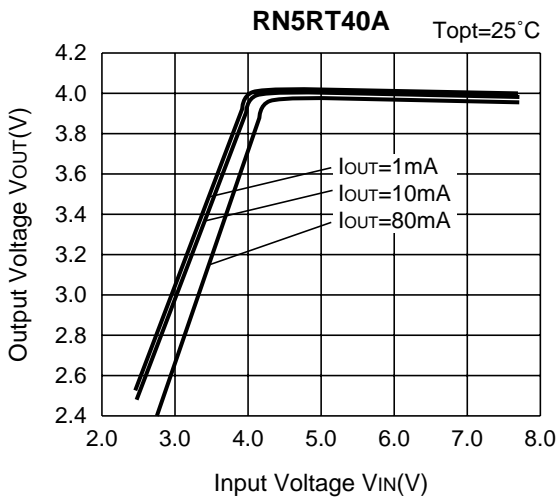

3) Dropout Voltage vs. Output Current

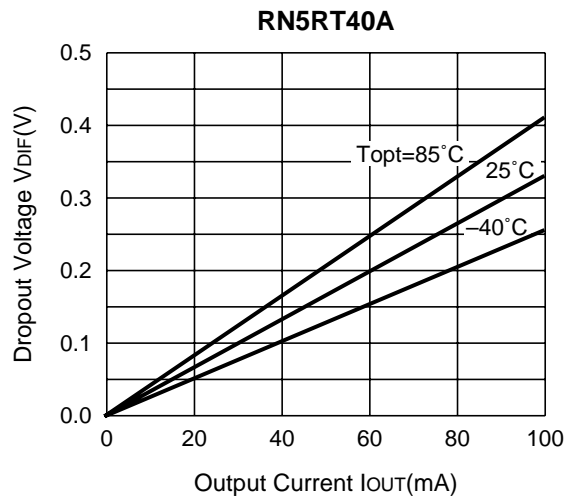
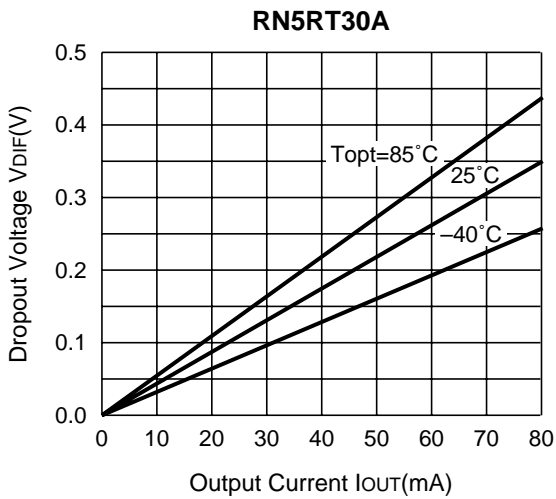

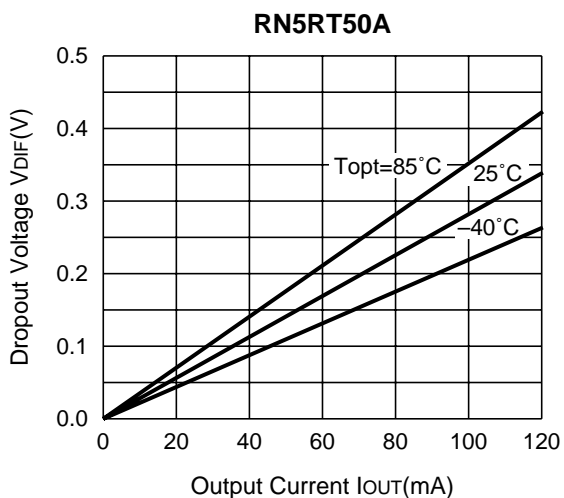

4) Output Voltage vs. Temperature

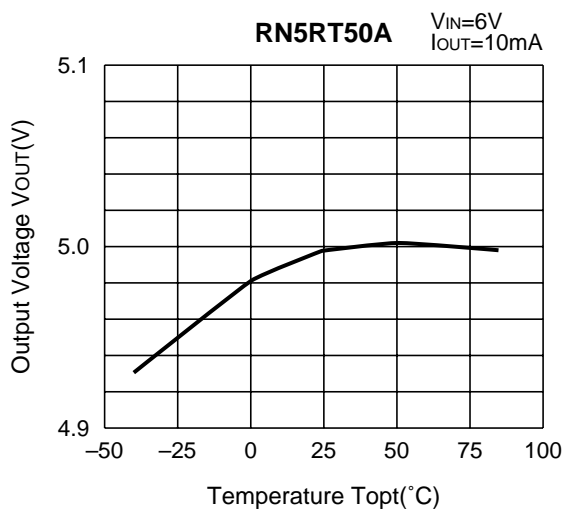
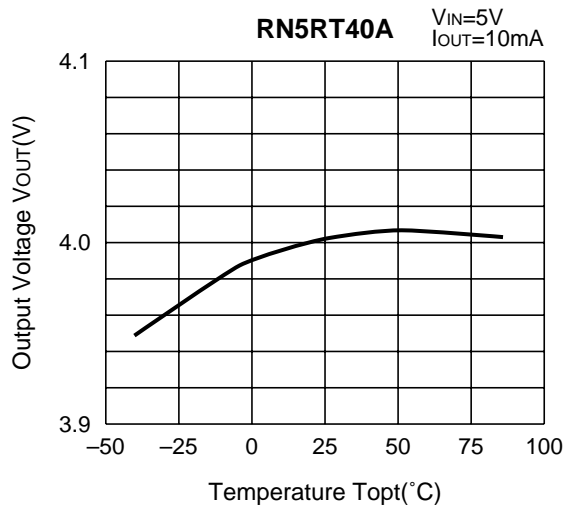
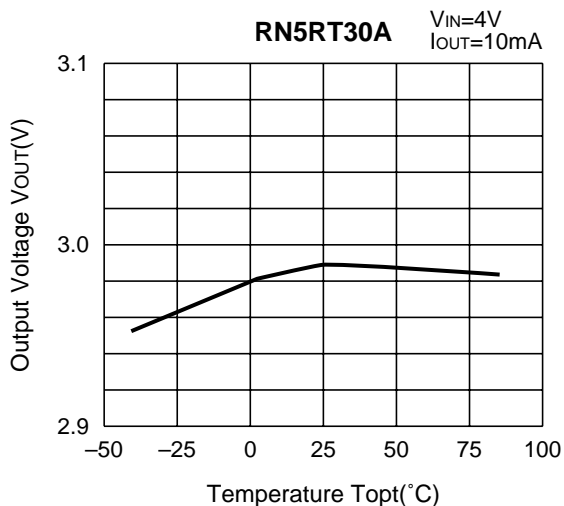

5) Supply Current vs. Input Voltage

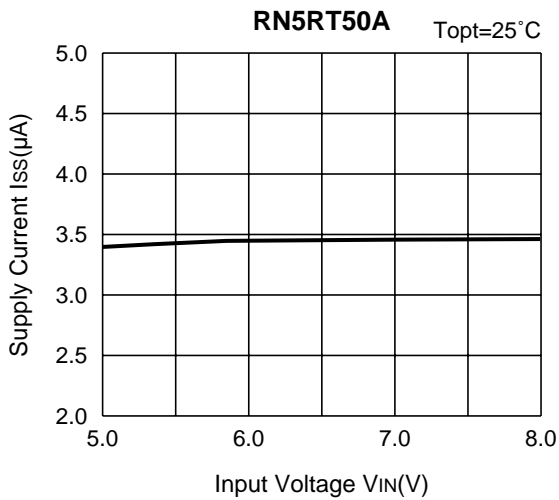
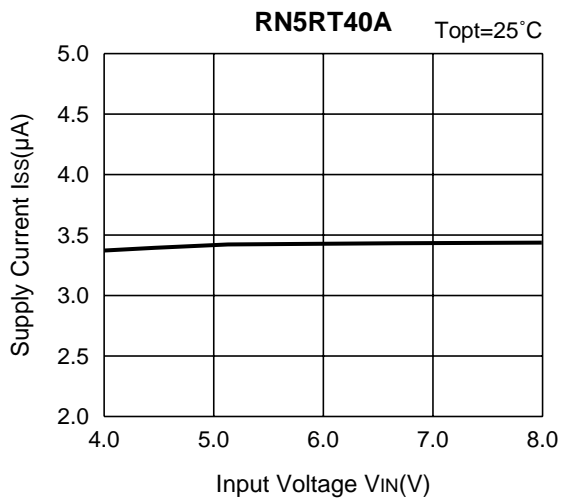
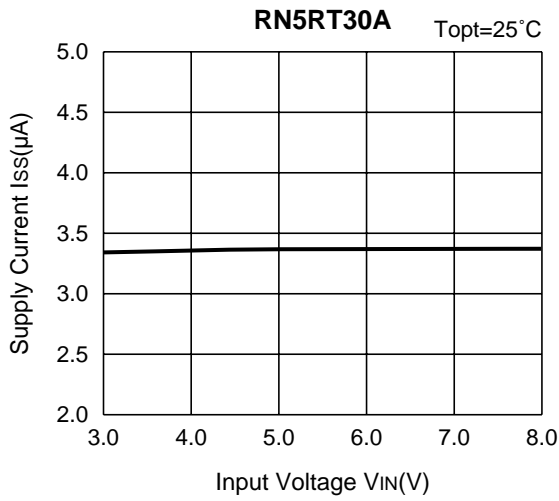

6) Supply Current vs. Temperature

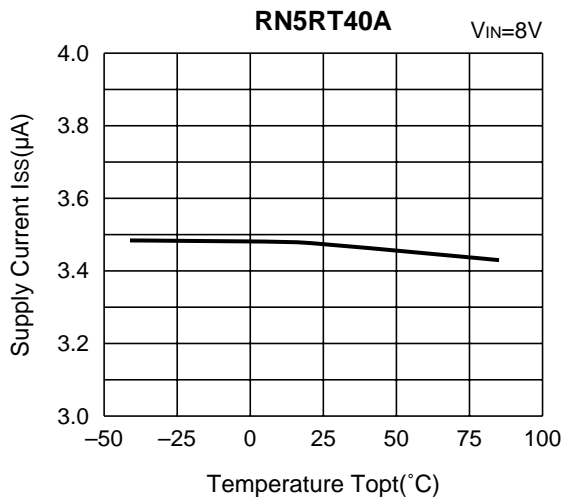
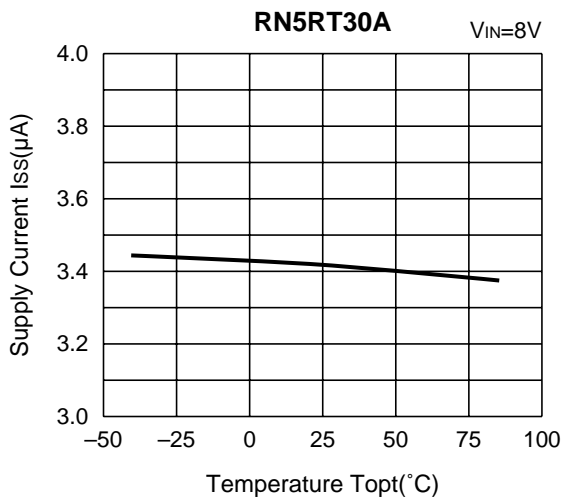

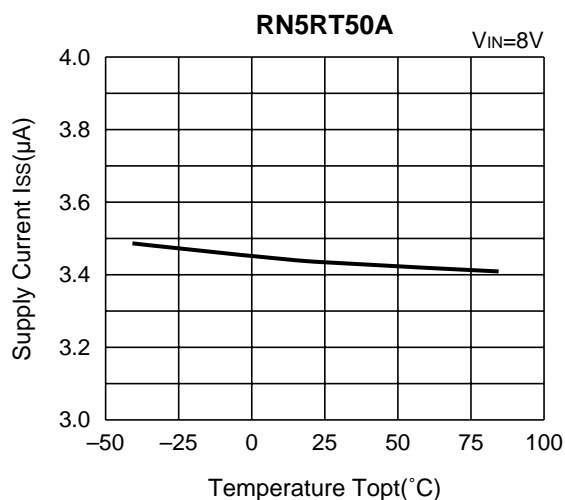

7) Dropout Voltage vs. Set Output Voltage

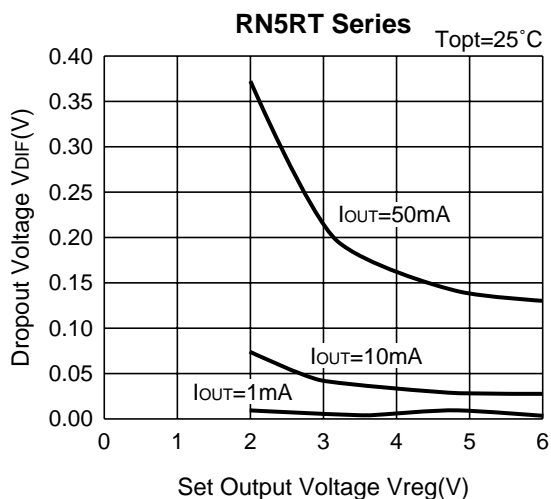

8) Line Transient Response

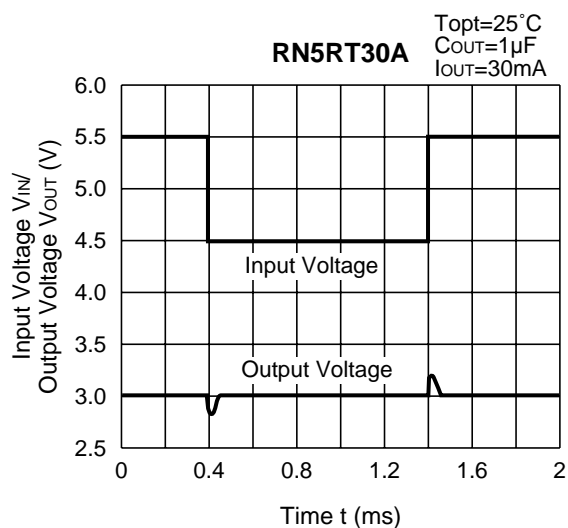
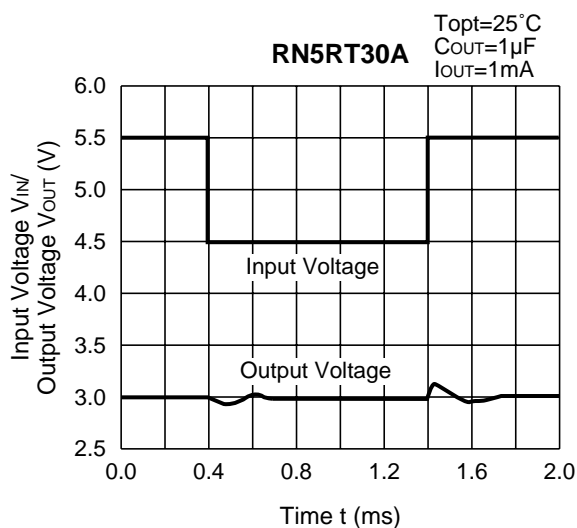

TYPICAL APPLICATION

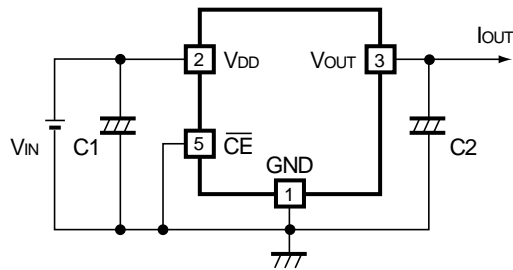

In the RN5RT Series, a constant voltage can be obtained without using capacitor C1 and C2. However, when the wire connected to V_{IN} is long, use a capacitor C1. Transient noise of output voltage occurred due to load deviation can be reduced by using a capacitor C2.

Insert capacitors C1 and C2 with the capacitance of 0.1 μ F to 2.0 μ F between input/output pins and GND pin with minimum wiring.



1. The products and the product specifications described in this document are subject to change or discontinuation of production without notice for reasons such as improvement. Therefore, before deciding to use the products, please refer to our sales representatives for the latest information thereon.
2. The materials in this document may not be copied or otherwise reproduced in whole or in part without prior written consent of our company.
3. Please be sure to take any necessary formalities under relevant laws or regulations before exporting or otherwise taking out of your country the products or the technical information described herein.
4. The technical information described in this document shows typical characteristics of and example application circuits for the products. The release of such information is not to be construed as a warranty of or a grant of license under our company's or any third party's intellectual property rights or any other rights.
5. The products listed in this document are intended and designed for use as general electronic components in standard applications (office equipment, telecommunication equipment, measuring instruments, consumer electronic products, amusement equipment etc.). Those customers intending to use a product in an application requiring extreme quality and reliability, for example, in a highly specific application where the failure or misoperation of the product could result in human injury or death (aircraft, spacevehicle, nuclear reactor control system, traffic control system, automotive and transportation equipment, combustion equipment, safety devices, life support system etc.) should first contact us.
6. We are making our continuous effort to improve the quality and reliability of our products, but semiconductor products are likely to fail with certain probability. In order to prevent any injury to persons or damages to property resulting from such failure, customers should be careful enough to incorporate safety measures in their design, such as redundancy feature, fire containment feature and fail-safe feature. We do not assume any liability or responsibility for any loss or damage arising from misuse or inappropriate use of the products.
7. Anti-radiation design is not implemented in the products described in this document.
8. The X-ray exposure can influence functions and characteristics of the products. Confirm the product functions and characteristics in the evaluation stage.
9. WLCSP products should be used in light shielded environments. The light exposure can influence functions and characteristics of the products under operation or storage.
10. There can be variation in the marking when different AOI (Automated Optical Inspection) equipment is used. In the case of recognizing the marking characteristic with AOI, please contact our sales or our distributor before attempting to use AOI.
11. Please contact our sales representatives should you have any questions or comments concerning the products or the technical information.



Nisshinbo Micro Devices Inc.

Official website

<https://www.nisshinbo-microdevices.co.jp/en/>

Purchase information

<https://www.nisshinbo-microdevices.co.jp/en/buy/>

