



SGM8752-1Q

6.5ns, Rail-to-Rail I/O, High Speed, Automotive Comparator

GENERAL DESCRIPTION

The SGM8752-1Q is a single, high speed comparator, which features a fast 6.5ns propagation delay. The device is optimized for low voltage operation from 2.7V to 5.5V. The SGM8752-1Q has a push-pull CMOS output stage, which supports rail-to-rail output swing. It can be compatible with CMOS and TTL logics.

The SGM8752-1Q features a small package. It is suitable for portable and space-restricted applications. The SGM8752-1Q is available in a Green SOT-23-5 package. It is operated over the -40°C to +125°C temperature range.

This device is AEC-Q100 qualified (Automotive Electronics Council (AEC) standard Q100 Grade 1) and it is suitable for automotive applications.

FEATURES

- **AEC-Q100 Qualified for Automotive Applications**
Device Temperature Grade 1
 $T_A = -40^{\circ}\text{C}$ to $+125^{\circ}\text{C}$
- **High Speed: 6.5ns Propagation Delay**
- **Push-Pull CMOS Output Structure**
- **Rail-to-Rail Input and Output**
- **Supply Voltage: 2.7V to 5.5V**
- **Low Quiescent Current: 1.8mA**
- **Available in a Green SOT-23-5 Package**

APPLICATIONS

AEC-Q100 Grade 1 Applications
Window Comparators
Threshold Detectors
Zero-Crossing Detectors
Radio Base Stations
Automatic Test Equipment

PIN CONFIGURATION

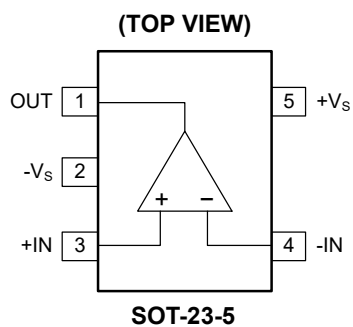

PIN DESCRIPTION

PIN	NAME	I/O	FUNCTION
1	OUT	O	Output.
2	-V _s	—	Negative Power Supply.
3	+IN	I	Non-Inverting Input.
4	-IN	I	Inverting Input.
5	+V _s	—	Positive Power Supply.

ELECTRICAL CHARACTERISTICS(V_S = 2.7V to 5.5V, Full = -40°C to +125°C, typical values are at T_A = +25°C, unless otherwise noted.)

PARAMETER	SYMBOL	CONDITIONS	TEMP	MIN	TYP	MAX	UNITS
Input Characteristics							
Input Offset Voltage ⁽¹⁾	V _{OS}	V _{CM} = 0V, I _{OUT} = 0mA	+25°C		±1	±6.5	mV
			Full			±7	
Input Offset Voltage Drift	ΔV _{OS} /ΔT		Full		5		μV/°C
Input Hysteresis			+25°C		6		mV
Input Bias Current	I _B	V _{CM} = V _S /2	+25°C		±20	±250	pA
			Full			±500	
Input Offset Current	I _{OS}	V _{CM} = V _S /2	+25°C		±20	±250	pA
			Full			±500	
Input Common Mode Voltage Range	V _{CM}		Full	(-V _S) - 0.2		(+V _S) + 0.2	V
Common Mode Rejection Ratio	CMRR	V _S = 5.5V, V _{CM} = -0.2V to (+V _S) + 0.2V	+25°C	57	74		dB
			Full	55			
		V _S = 2.7V, V _{CM} = -0.2V to (+V _S) + 0.2V	+25°C	52	70		
			Full	50			
Input Impedance							
Differential			+25°C		10 ¹² 4		Ω pF
Common Mode			+25°C		10 ¹² 2		Ω pF
Output Characteristics							
Output Voltage Swing from Rail	V _{OH} , V _{OL}	I _{OUT} = ±1mA	+25°C		40	50	mV
			Full			65	
Output Short-Circuit Current	I _{OUT}	V _S = 2.7V, R _L = 2Ω to GND	+25°C	20	25		mA
			Full	15			
		V _S = 5.5V, R _L = 2Ω to GND	+25°C	60	74		
			Full	46			
Power Supply							
Operating Voltage Range	V _S		Full	2.7		5.5	V
Quiescent Current	I _Q	V _S = 5V, V _{OUT} = High	+25°C		1.8	2.3	mA
			Full			3.2	
Power Supply Rejection Ratio	PSRR	V _S = 2.7V to 5.5V	+25°C		100	450	μV/V
			Full			650	

NOTE:

1. V_{OS} is the differential voltage which can make the output of the comparator equals to 0V.

SWITCHING CHARACTERISTICS(V_S = 2.7V to 5.5V, C_L = 15pF, Full = -40°C to +125°C, typical values are at T_A = +25°C, unless otherwise noted.)

PARAMETER	SYMBOL	CONDITIONS	TEMP	MIN	TYP	MAX	UNITS
Propagation Delay Time ⁽¹⁾⁽²⁾	t _{PD}	ΔV _{IN} = 100mV, overdrive = 20mV	Full		6.5	9	ns
		ΔV _{IN} = 100mV, overdrive = 5mV	Full		8.5	13	
Propagation Delay Skew ⁽³⁾	Δt _{SK}	ΔV _{IN} = 100mV, overdrive = 20mV	+25°C		1.3		ns
Maximum Toggle Frequency	f _{MAX}	V _S = 5V, overdrive = 50mV	+25°C		60		MHz
Rise Time ⁽⁴⁾	t _R		+25°C		1.2		ns
Fall Time ⁽⁴⁾	t _F		+25°C		0.9		ns

NOTES:

1. Specified by design and characterization; not production tested.
2. For low overdrive voltages, the propagation delay measured during production testing is not accurate. This parameter is derived from data measured with a 100mV overdrive voltage.
3. The propagation delay skew is defined as the time difference between propagation delay going high and going low.
4. The rise time is measured between 10% and 90% of the full scale voltage.

TYPICAL PERFORMANCE CHARACTERISTICS

At $T_A = +25^\circ\text{C}$, $V_S = 5\text{V}$ and Overdrive = 100mV, unless otherwise noted.

Output Response for Various Overdrive Voltages (L-H)

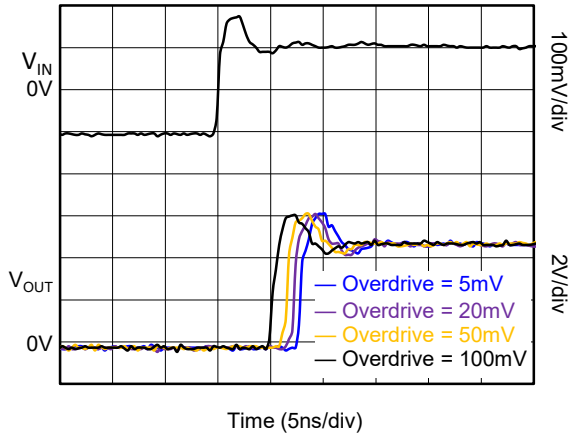

Output Response for Various Overdrive Voltages (H-L)

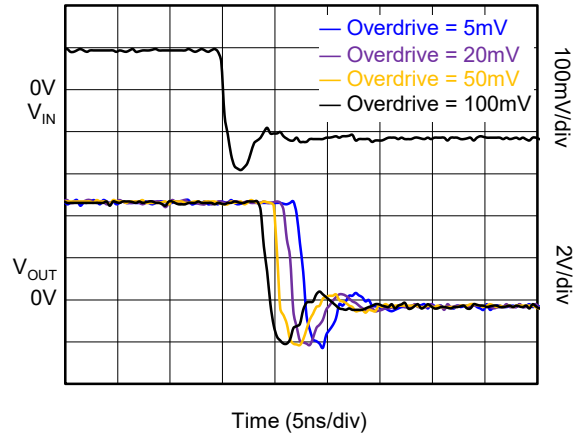

Response to 50MHz Sine Wave

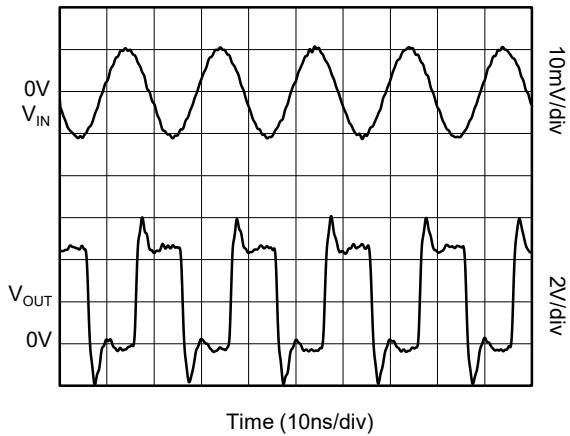

Response to 100MHz Square Wave

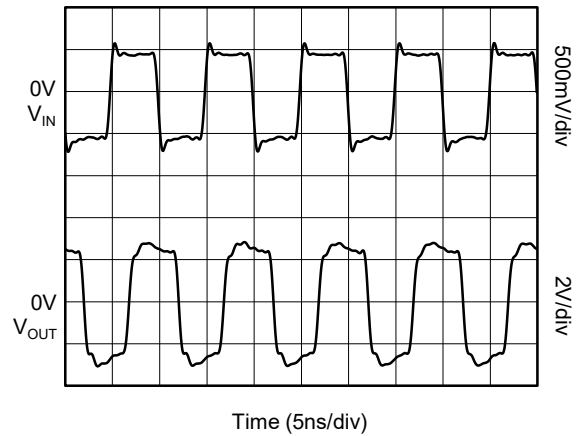

Propagation Delay vs. Temperature

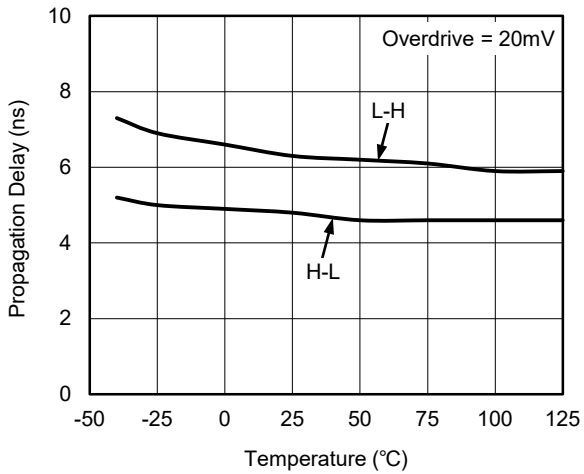

Propagation Delay vs. Temperature

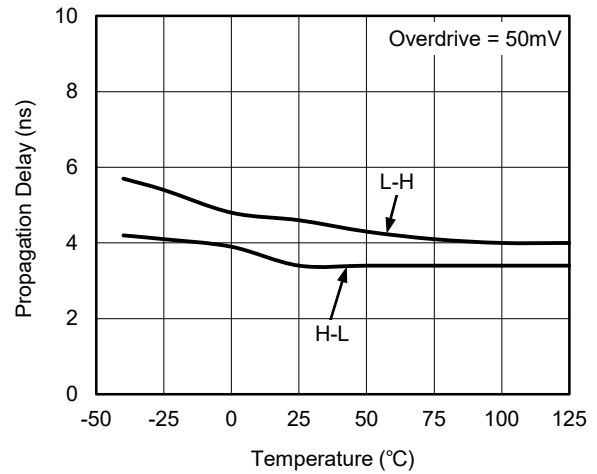

TYPICAL PERFORMANCE CHARACTERISTICS (continued)

At $T_A = +25^\circ\text{C}$, $V_S = 5\text{V}$ and Overdrive = 100mV, unless otherwise noted.

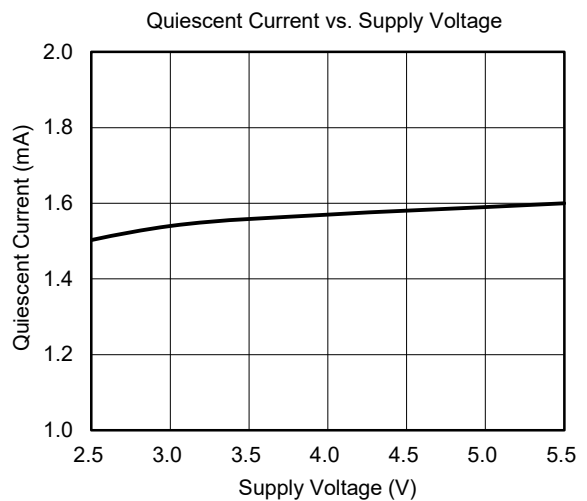
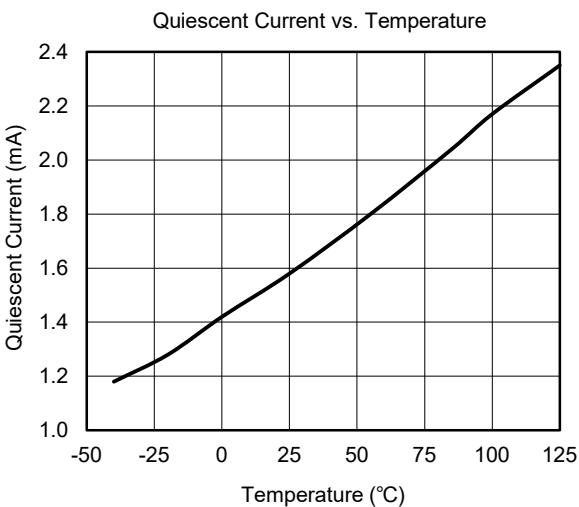
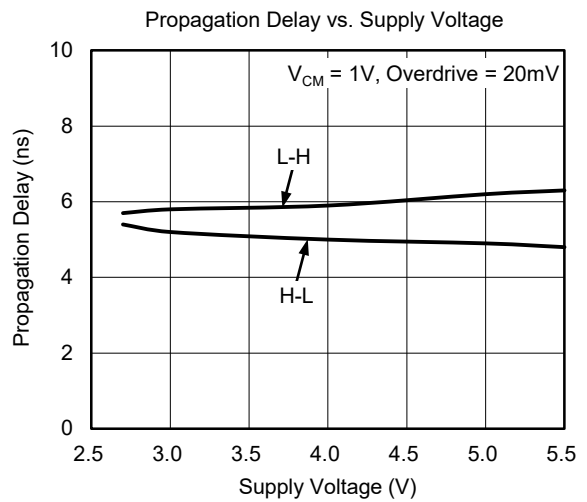
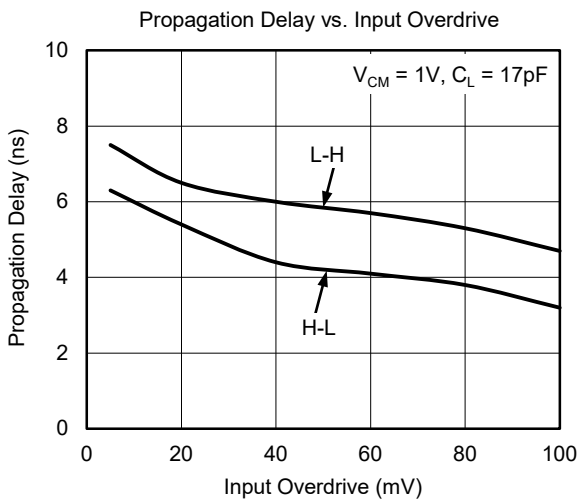
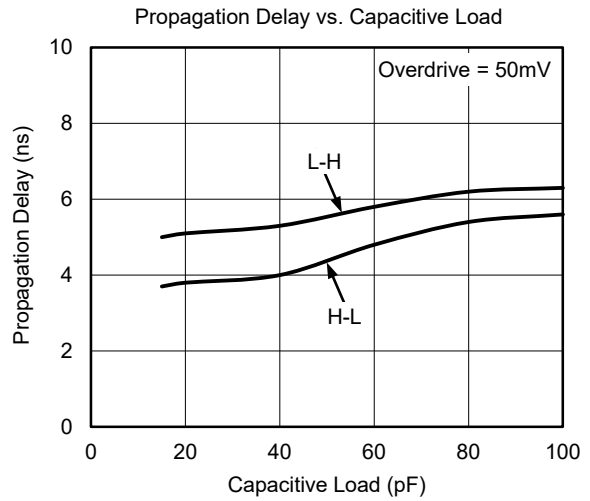
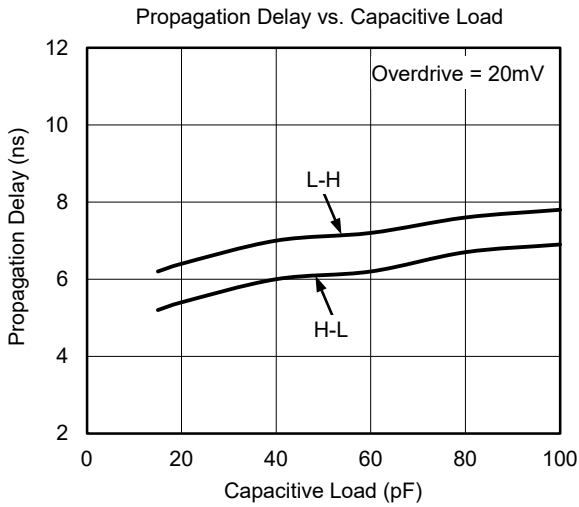

TYPICAL PERFORMANCE CHARACTERISTICS (continued)

At $T_A = +25^\circ\text{C}$, $V_S = 5\text{V}$ and Overdrive = 100mV, unless otherwise noted.

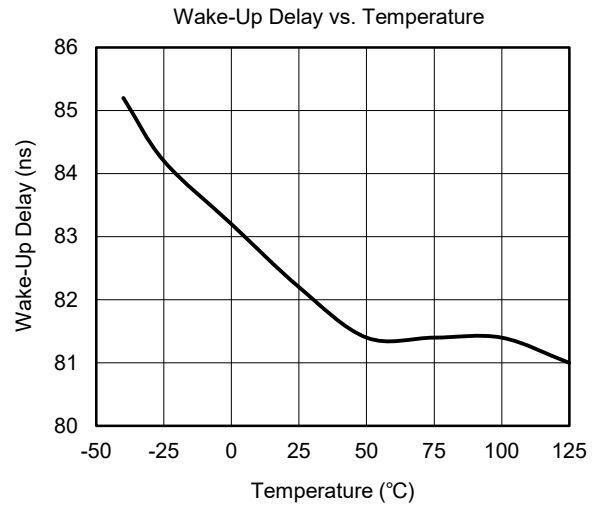
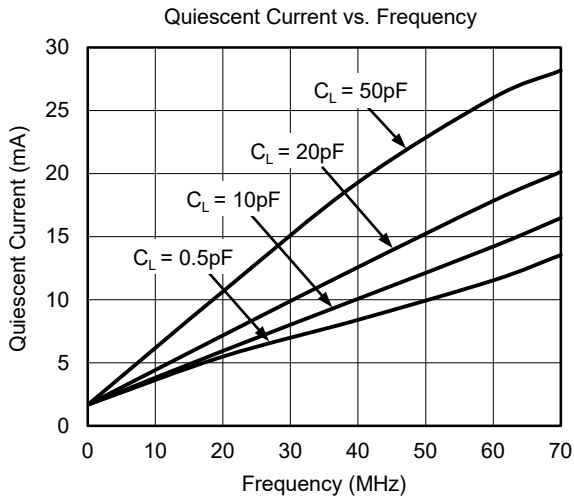

FUNCTIONAL BLOCK DIAGRAM

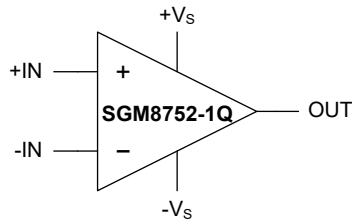

Figure 1. Block Diagram

DETAILED DESCRIPTION

The SGM8752-1Q is a comparator with extreme high speed and 6mV hysteresis, which helps to improve the noise immunity. The common mode range extends 0.2V beyond the power supply voltage rails.

Operating Voltage

The SGM8752-1Q can operate from 2.7V to 5.5V single supply or from $\pm 1.35\text{V}$ to $\pm 2.75\text{V}$ dual supplies over the -40°C to $+125^\circ\text{C}$ temperature range.

Input Over-Voltage Protection

In the internal of SGM8752-1Q, ESD diodes are used to protect the device from higher voltages (300mV greater than the supply voltage). However, adding a resistor at the input of the comparator is a good choice

to absorb the momentary voltage which is greater than 300mV by limiting the current within 10mA.

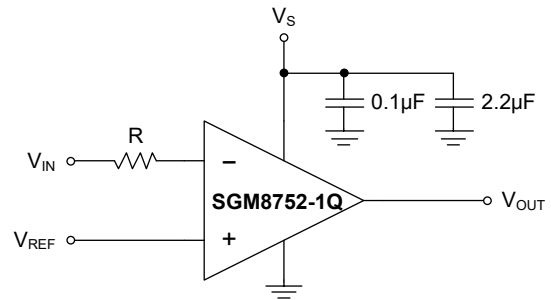

Figure 2. Current Limit by Adding a Resistor

APPLICATION INFORMATION

Adding External Hysteresis

The effect of significant input noise is an issue that has to be taken into consideration for applications with slow moving or noisy input signals. The output will switch as the result of the input noise, although there is 6mV internal hysteresis. For this case, it is recommended to add external resistors at the positive terminal of the comparator. For the circuit which is shown in Figure 3, the external 25mV hysteresis is added so the total hysteresis is 31mV, which will improve the noise immunity. The equation shown as below is used to calculate the total supported hysteresis of the circuit.

$$V_{HYST} = \frac{(+V_S) \times R_1}{R_1 + R_2} + 6mV \tag{1}$$

V_{HYST} is the required transition voltage range for switching the device; therefore, the noise immunity is improved.

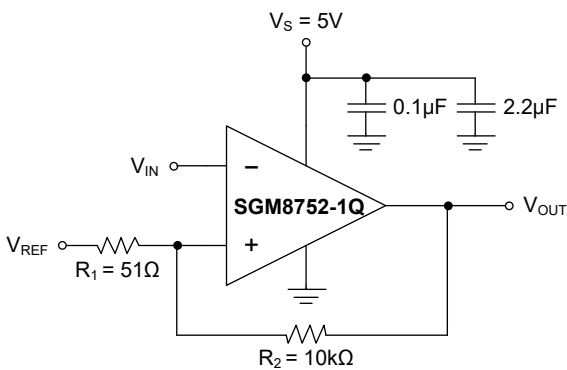

Figure 3. Adding Hysteresis to the SGM8752-1Q

Relaxation Oscillator

A relaxation oscillator can be made by SGM8752-1Q due to its high speed property. For the following circuit, the R_2 network with the same resistance sets two trip points which are $1/3V_S$ and $2/3V_S$. The resistance of R_2 network should be small enough to reject the effect of parasitic capacitance as the operation of SGM8752-1Q is high speed. The $1/3V_S$ and $2/3V_S$ are the two thresholds of the input signal, which can switch the output of the signal. Also, after calculation, the sum of charging and discharging period is $2\ln 2 \times R_1C$. With the application which is shown as below, the calculated oscillated frequency is equal to 10.9MHz. However, because of the parasitic capacitance, the theoretical frequency is around 9.6MHz.

Design Requirements

For the R_2 network, the users must set values of three resistors equally to ensure that the two trip points are equal to $1/3V_S$ and $2/3V_S$. Also, the resistance of R_2 network should be small enough to reject the effect of parasitic capacitance. In addition, there are two requirements for the value of R_1 , which are drawing less current and providing high switching frequency. On top of this, higher capacitance for the capacitor is required for improving the error which is caused by the tolerance and parasitic capacitance.

Detailed Design Procedure

For the application, the positive input, $+V_{IN}$ is equal to the $1/3V_S$ if the V_{OL} is close to GND. And $+V_{IN}$ is equal to $2/3V_S$ if the V_{OH} is close to V_S .

The charging and discharging periods at the negative input and which are reflected at V_C , are the same, and the value of charging and discharging period is equal to R_1C .

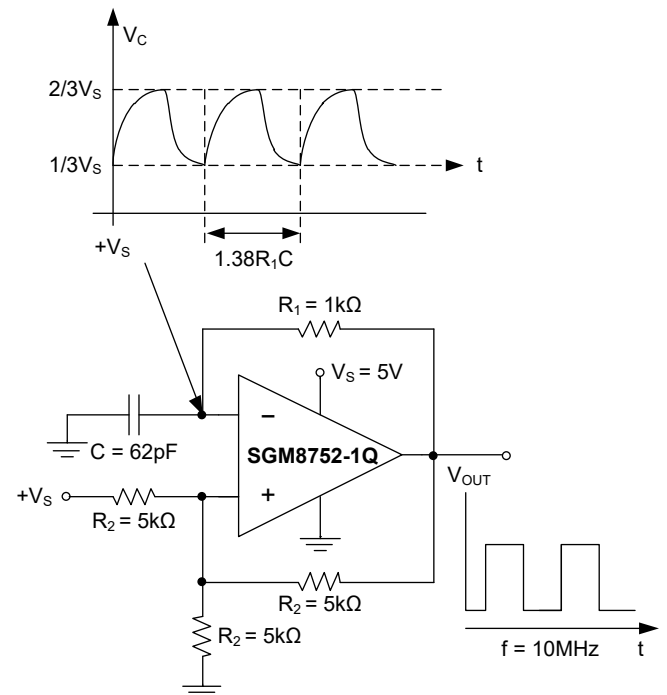

Figure 4. Relaxation Oscillator

APPLICATION INFORMATION (continued)

High Speed Window Comparator

The output of the window comparator will switch if the input of the circuit reaches its V_{OL} or V_{OH} . Because SGM8752-1Q is a high speed comparator, it is excellent to use the device for the designing of a high speed window comparator, with two thresholds V_{HI} and V_{LO} . If the voltage level of V_{IN} is between the two thresholds of the circuit, the output of the circuit will be in high position. For the application of active low which is shown in Figure 6, the position of V_{HI} and V_{LO} is different from the application in Figure 5. On top of this, the supported voltage ranges for both of the applications are from 2.7V to 5.5V.

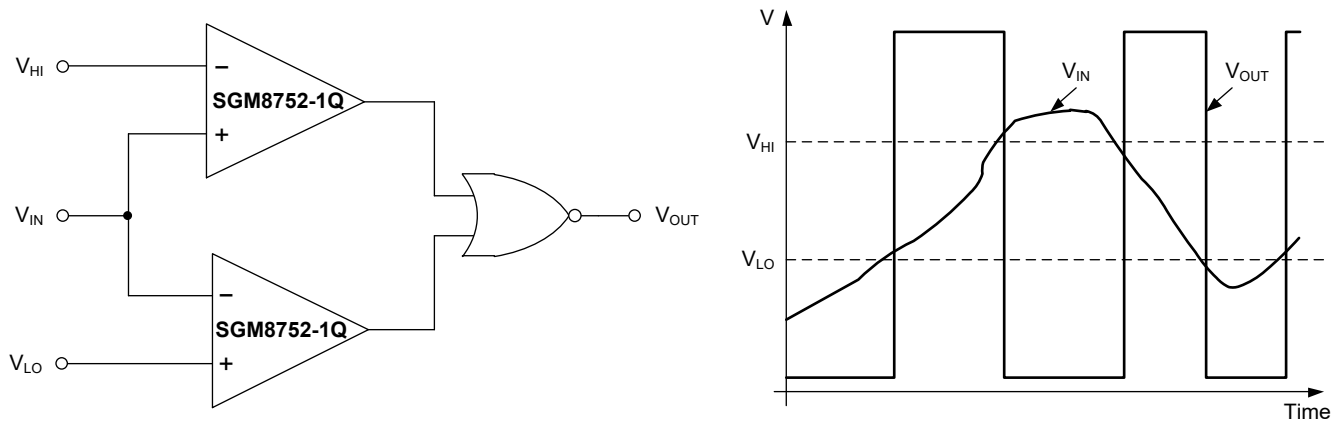

Figure 5. Window Comparator - Active High

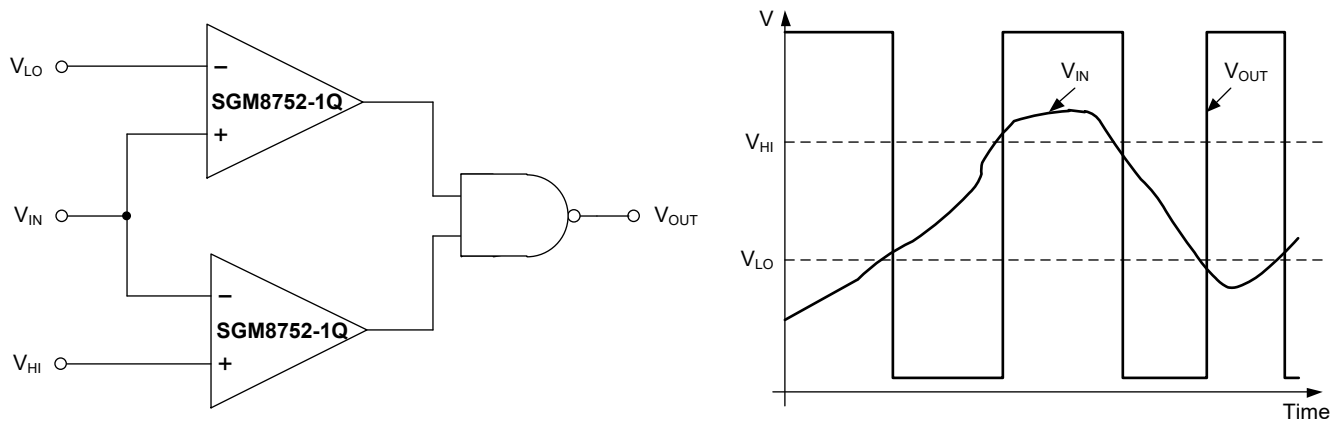

Figure 6. Window Comparator - Active Low

APPLICATION INFORMATION (continued)

Power Supply Recommendations

The SGM8752-1Q can be used for both single and dual power supply modes with the temperature from -40°C to $+125^{\circ}\text{C}$. For the noisy or high impedance power supply condition, a bypass capacitor should be added closed to the power supply pin to enhance the stability. The section of Layout illustrates how to place the bypass capacitor.

Layout

An excellent design for PCB layout is necessary for high speed devices. Any stray capacitance or improper grounding will influence the performance of the high speed comparator.

In order to minimize the propagation delay, the users should make sure that the resistance of the signal source is as low as possible. The resistance from the input signal and the stray capacitance can create an RC filter, which can decrease the amplitude for high-frequency component. In addition, the input

capacitance and the stray capacitance result in several pF capacitances.

The paralleled $2.2\mu\text{F}$ and $0.1\mu\text{F}$ ceramic capacitors need to be placed as close to the device. The $2.2\mu\text{F}$ capacitor is used to enhance the stability by rejecting the ripple, and $0.1\mu\text{F}$ capacitor provides a charge for high-frequency component.

For high speed applications, the rising or falling edge of the signal will cause a potential DC voltage shift. For minimizing this negative influence, a plane of GND should be taken into account as it can reduce the effect of stray capacitance. Also, the ground plane can provide multiple paths for the current flow. In addition, for the high speed signal, the current will flow back at GND plane under its previous signal path. Any hole and via can increase the inductance which can reduce the performance of the high speed transmission. If vias are necessary at the ground plane, please place them randomly.

REVISION HISTORY

NOTE: Page numbers for previous revisions may differ from page numbers in the current version.

MAY 2023 – REV.A to REV.A.1	Page
Updated Absolute Maximum Ratings section.....	2
Updated Switching Characteristics section	5

Changes from Original (MAY 2023) to REV.A	Page
Changed from product preview to production data.....	All

PACKAGE INFORMATION

PACKAGE OUTLINE DIMENSIONS

SOT-23-5

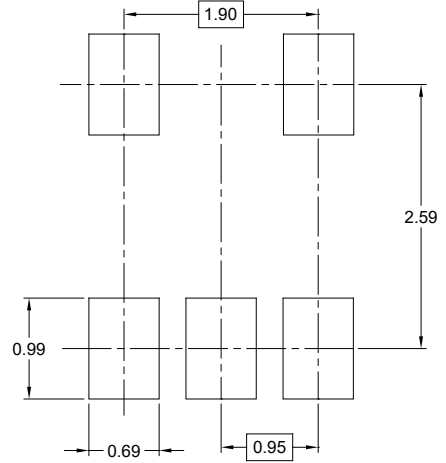
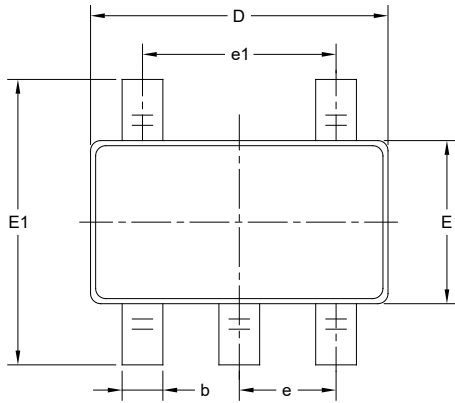

RECOMMENDED LAND PATTERN (Unit: mm)

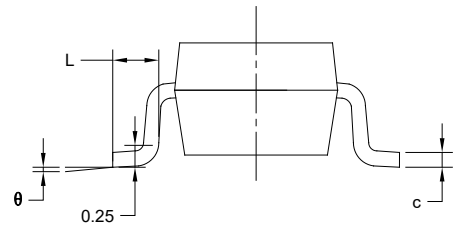
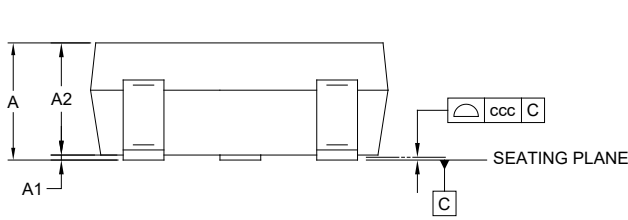

Symbol	Dimensions In Millimeters		
	MIN	MOD	MAX
A	-	-	1.450
A1	0.000	-	0.150
A2	0.900	-	1.300
b	0.300	-	0.500
c	0.080	-	0.220
D	2.750	-	3.050
E	1.450	-	1.750
E1	2.600	-	3.000
e	0.950 BSC		
e1	1.900 BSC		
L	0.300	-	0.600
θ	0°	-	8°
ccc	0.100		

NOTES:

1. This drawing is subject to change without notice.
2. The dimensions do not include mold flashes, protrusions or gate burrs.
3. Reference JEDEC MO-178.

PACKAGE INFORMATION

TAPE AND REEL INFORMATION

REEL DIMENSIONS



TAPE DIMENSIONS



NOTE: The picture is only for reference. Please make the object as the standard.

KEY PARAMETER LIST OF TAPE AND REEL

Package Type	Reel Diameter	Reel Width W1 (mm)	A0 (mm)	B0 (mm)	K0 (mm)	P0 (mm)	P1 (mm)	P2 (mm)	W (mm)	Pin1 Quadrant
SOT-23-5	7"	9.5	3.20	3.20	1.40	4.0	4.0	2.0	8.0	Q3

000001

PACKAGE INFORMATION

CARTON BOX DIMENSIONS



NOTE: The picture is only for reference. Please make the object as the standard.

KEY PARAMETER LIST OF CARTON BOX

Reel Type	Length (mm)	Width (mm)	Height (mm)	Pizza/Carton
7" (Option)	368	227	224	8
7"	442	410	224	18

DD0002