



SGM8714A-1/SGM8714B-1

Nano-Power, Small Size, Low Voltage Comparators

GENERAL DESCRIPTION

The SGM8714A-1 and SGM8714B-1 are single, nano-power, small size comparators. They are optimized for low voltage operation from 1.6V to 5.5V single supply, and consume only 300nA quiescent current. Both devices are packaged in a space-saving XTDFN package, which is 1mm × 1mm. The combination of these features makes them good choices for smart battery-powered equipment. Meanwhile, the SGM8714A-1 and SGM8714B-1 also have a great trade-off between low power and high speed, whose propagation delay is only 6μs. This results in a continuous system monitoring and quick respond to fault conditions without too much battery power dissipation.

These devices have different output structures. The SGM8714A-1 has a push-pull output structure, which can easily drive the LED, resistive or capacitive load with the ability of sourcing or sinking the current for the level of milliamp. The SGM8714B-1 has an open-drain output structure, which needs an external pull-up resistor to output a high level of V_S or a voltage below V_S . So it enables conversion from bipolar to single-ended signals and level translation. A clamp diode is designed between the OUT pin and the $+V_S$ pin to avoid the SGM8714A-1 and SGM8714B-1 being damaged when the output voltage exceeds the power supply.

The SGM8714A-1 and SGM8714B-1 are both available in a Green XTDFN-1×1-6L package. They are rated over the -40 °C to +125 °C operating temperature range.

FEATURES

- **Ultra-Low Supply Current: 300nA (TYP)**
- **Low Propagation Delay: 6μs (TYP)**
- **Supply Voltage Range: 1.6V to 5.5V**
- **Rail-to-Rail Input Common Mode Voltage**
- **Different Output Structures**
 - ◆ **Push-Pull Output: SGM8714A-1**
 - ◆ **Open-Drain Output: SGM8714B-1**
- **Internal Hysteresis: 6mV (TYP)**
- **-40°C to +125°C Operating Temperature Range**
- **Available in a Green XTDFN-1×1-6L Package**

APPLICATIONS

Cell Phones
Battery-Powered Equipment
IR Receivers

PACKAGE/ORDERING INFORMATION

MODEL	PACKAGE DESCRIPTION	SPECIFIED TEMPERATURE RANGE	ORDERING NUMBER	PACKAGE MARKING	PACKING OPTION
SGM8714A-1	XTDFN-1×1-6L	-40°C to +125°C	SGM8714A-1XXDM6G/TR	JX	Tape and Reel, 10000
SGM8714B-1	XTDFN-1×1-6L	-40°C to +125°C	SGM8714B-1XXDM6G/TR	KX	Tape and Reel, 10000

MARKING INFORMATION

NOTE: X = Date Code.

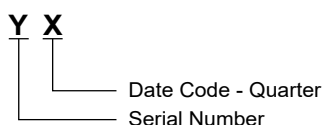

Green (RoHS & HSF): SG Micro Corp defines "Green" to mean Pb-Free (RoHS compatible) and free of halogen substances. If you have additional comments or questions, please contact your SGMICRO representative directly.

ABSOLUTE MAXIMUM RATINGS

- Supply Voltage, +V_S to -V_S 6V
- Voltage at Input/Output Pins (-V_S) - 0.3V to (+V_S) + 0.3V
- Differential Input Voltage, |V_{ID}| V_S
- Junction Temperature +150°C
- Storage Temperature Range -65°C to +150°C
- Lead Temperature (Soldering, 10s) +260°C
- ESD Susceptibility
- HBM 8000V
- CDM 1000V

RECOMMENDED OPERATING CONDITIONS

- Supply Voltage 1.6V to 5.5V
- Operating Temperature Range -40°C to +125°C

OVERSTRESS CAUTION

Stresses beyond those listed in Absolute Maximum Ratings may cause permanent damage to the device. Exposure to absolute maximum rating conditions for extended periods

may affect reliability. Functional operation of the device at any conditions beyond those indicated in the Recommended Operating Conditions section is not implied.

ESD SENSITIVITY CAUTION

This integrated circuit can be damaged if ESD protections are not considered carefully. SGMICRO recommends that all integrated circuits be handled with appropriate precautions. Failure to observe proper handling and installation procedures can cause damage. ESD damage can range from subtle performance degradation to complete device failure. Precision integrated circuits may be more susceptible to damage because even small parametric changes could cause the device not to meet the published specifications.

DISCLAIMER

SG Micro Corp reserves the right to make any change in circuit design, or specifications without prior notice.

PIN CONFIGURATION

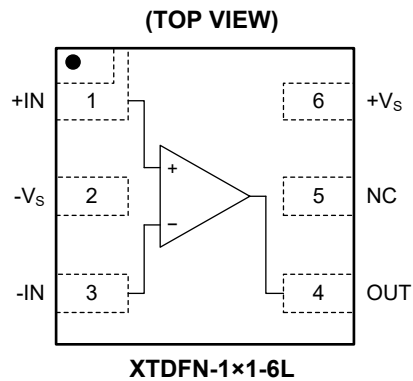

PIN DESCRIPTION

PIN	NAME	FUNCTION
1	+IN	Non-Inverting Input.
2	-Vs	Negative Power Supply.
3	-IN	Inverting Input.
4	OUT	Output.
5	NC	Not Connected.
6	+Vs	Positive Power Supply.

ELECTRICAL CHARACTERISTICS

($V_S = 1.6V$ to $5V$, $V_{CM} = V_S/2$, Full = $-40^\circ C$ to $+125^\circ C$, typical values are at $T_A = +25^\circ C$, unless otherwise noted.)

PARAMETER	SYMBOL	CONDITIONS	TEMP	MIN	TYP	MAX	UNITS
Input Offset Voltage	V_{OS}	$V_{CM} = V_S/2$	+25°C		1	10	mV
			Full			12	
Hysteresis	V_{HYST}	$V_{CM} = V_S/2$	+25°C	3	6	8	mV
			Full	1.5		10	
Input Common Mode Voltage Range	V_{CM}		Full	$-V_S$		V_S	V
Input Bias Current	I_B	$V_S = 5V, V_{CM} = V_S/2$	+25°C		15		pA
Input Offset Current	I_{OS}	$V_S = 5V, V_{CM} = V_S/2$	+25°C		20		pA
Output Voltage High (for SGM8714A-1 Only)	V_{OH}	$V_S = 5V, I_{OUT} = 3mA$	+25°C	4.79	4.855		V
			Full	4.75			
Output Voltage Low	V_{OL}	$V_S = 5V, I_{OUT} = -3mA$	+25°C		85	150	mV
			Full			175	
Open-Drain Output Leakage Current (for SGM8714B-1 Only)	I_{LKG}	$V_S = 5V, V_{ID} = +0.1V$ (output high), $V_{PULL-UP} = V_S$	+25°C		30		pA
Common Mode Rejection Ratio	CMRR	$-V_S < V_{CM} < V_S$	+25°C	52	69		dB
			Full	45			
Power Supply Rejection Ratio	PSRR	$V_S = 1.6V$ to $5.5V, V_{CM} = V_S/2$	+25°C	66	88		dB
			Full	61			
Short-Circuit Current	I_{SC}	$V_S = 5V$, sourcing (for SGM8714A-1 only)	+25°C	27	36		mA
		$V_S = 5V$, sinking	+25°C	39	60		
Quiescent Current	I_Q	$V_S = 5V, I_{OUT} = 0A, V_{ID} = -0.1V$ (output low)	+25°C		300	540	nA
			Full			755	

SWITCHING CHARACTERISTICS

($V_S = 5V, V_{CM} = 2.5V, C_L = 15pF$, input overdrive = $100mV$, typical values are at $T_A = +25^\circ C$, unless otherwise noted.)

PARAMETER	SYMBOL	CONDITIONS	TEMP	MIN	TYP	MAX	UNITS
Propagation Delay Time, High-to-Low (for SGM8714B-1 Only)	t_{PHL}	$R_P = 2.5k\Omega$	+25°C		4		μs
Propagation Delay Time, Low-to-High (for SGM8714B-1 Only)	t_{PLH}	$R_P = 2.5k\Omega$	+25°C		6		μs
Rise Time (for SGM8714A-1 Only)	t_R	20% to 80%	+25°C		6		ns
Fall Time	t_F	80% to 20%	+25°C		6		ns
Power-Up Time	t_{ON}		+25°C		1		ms

TIMING DIAGRAM

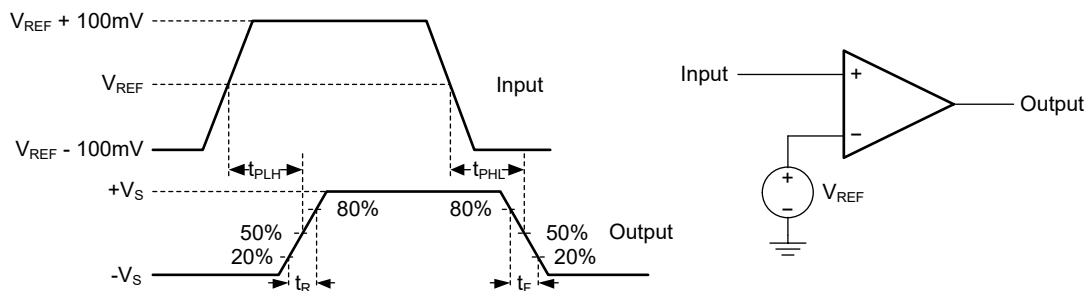

NOTE: The offset voltage and the hysteresis result in the propagation delay of the comparator output.

Figure 1. Propagation Delay Timing Diagram

TYPICAL PERFORMANCE CHARACTERISTICS

At $T_A = +25^\circ\text{C}$, unless otherwise noted.

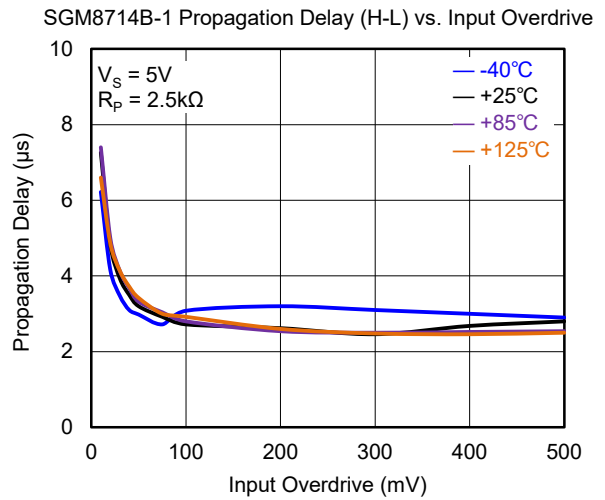
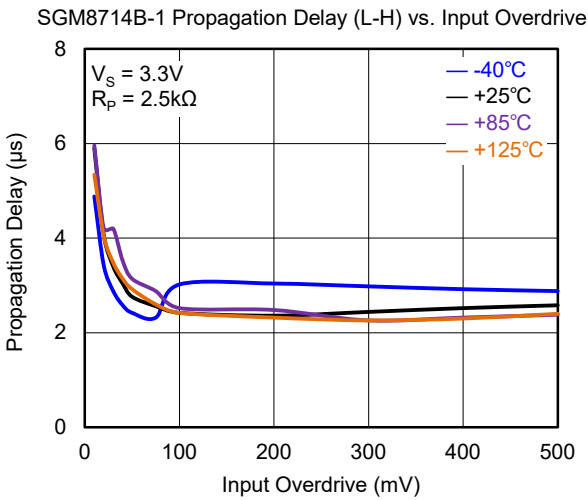
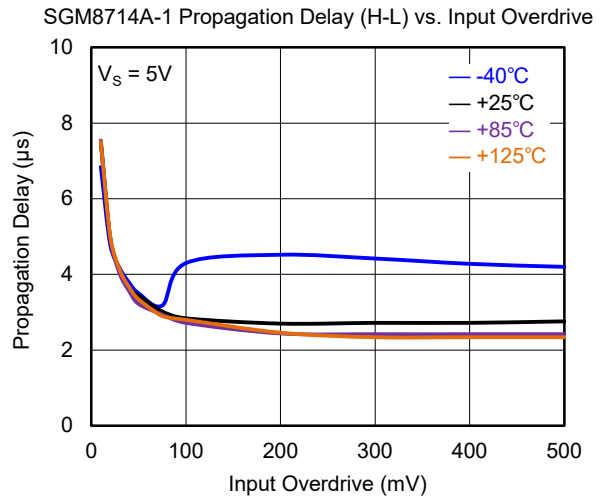
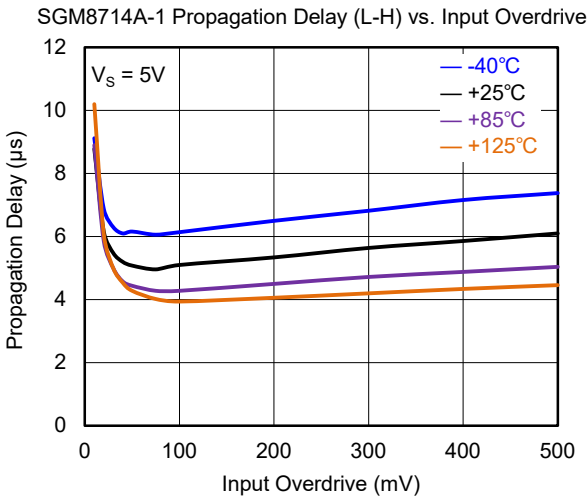
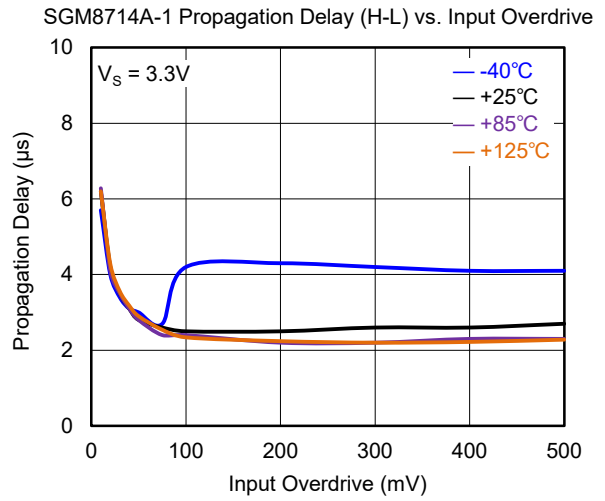
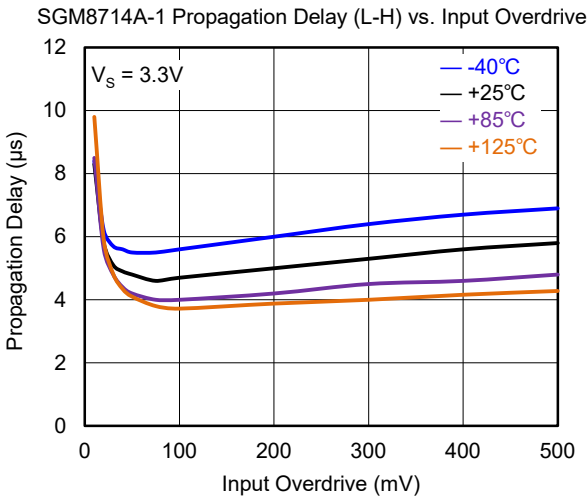

TYPICAL PERFORMANCE CHARACTERISTICS (continued)

At $T_A = +25^\circ\text{C}$, unless otherwise noted.

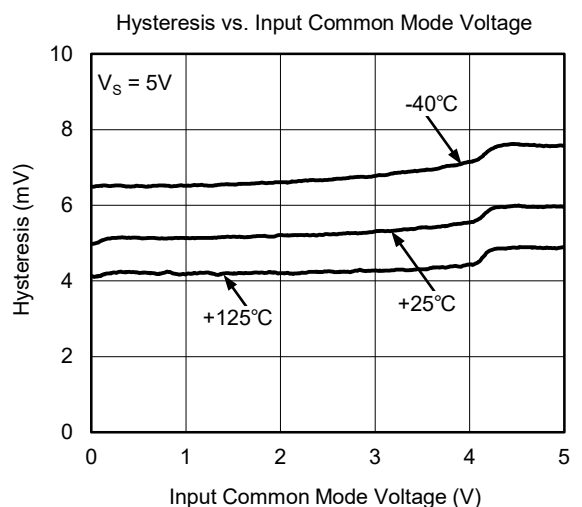
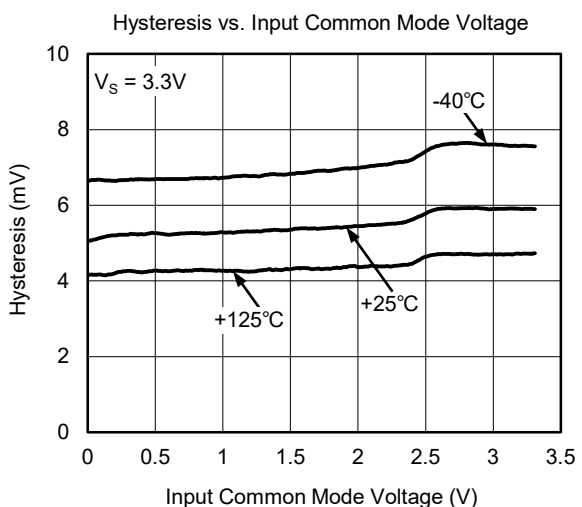
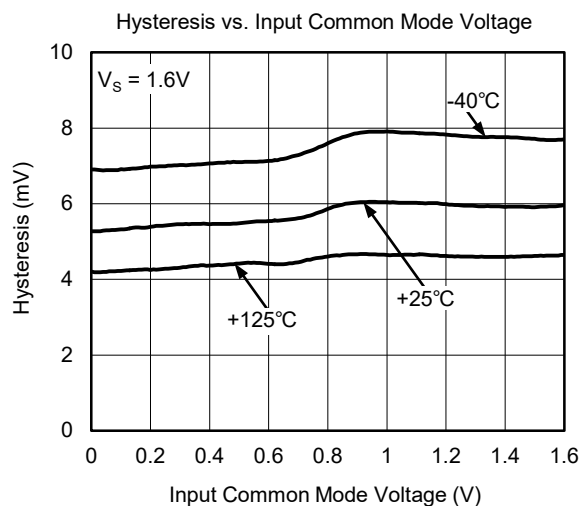
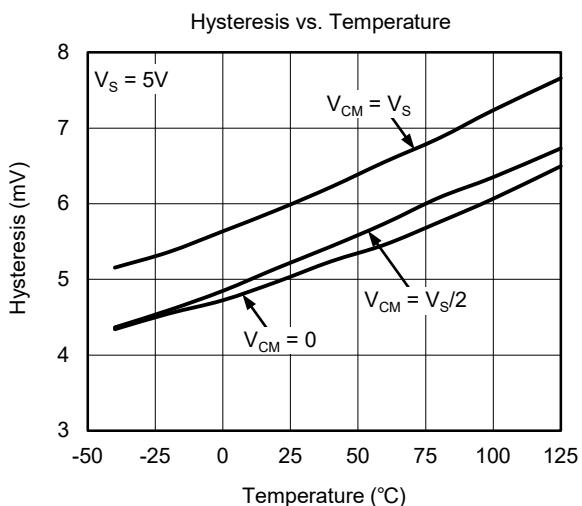
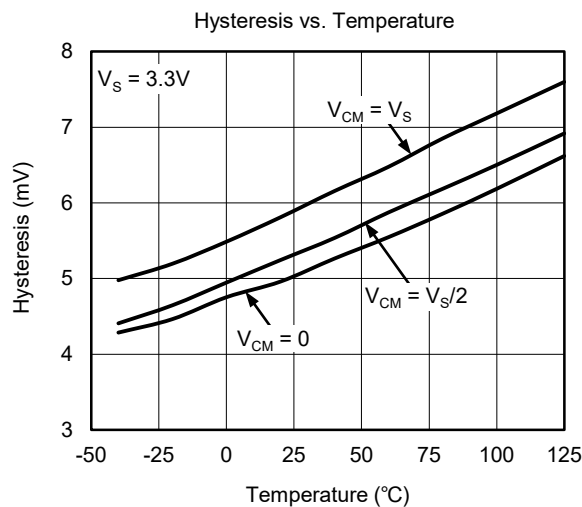
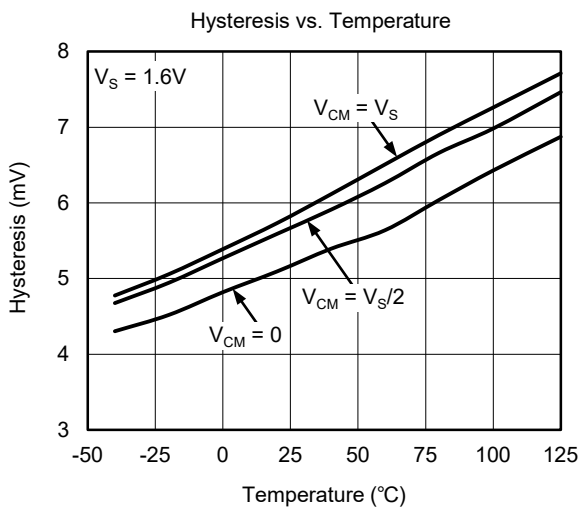

TYPICAL PERFORMANCE CHARACTERISTICS (continued)

At $T_A = +25^\circ\text{C}$, unless otherwise noted.

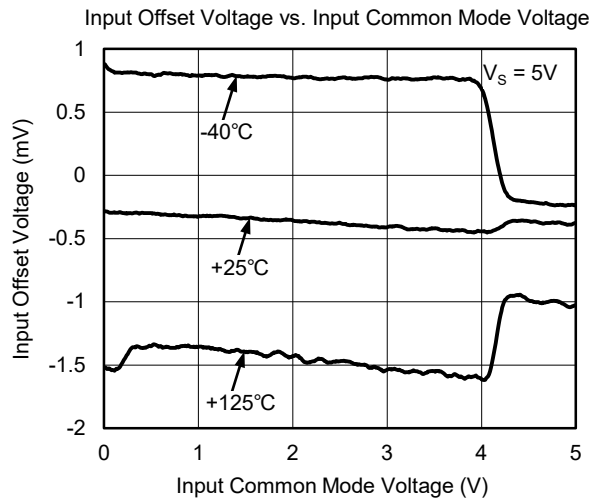
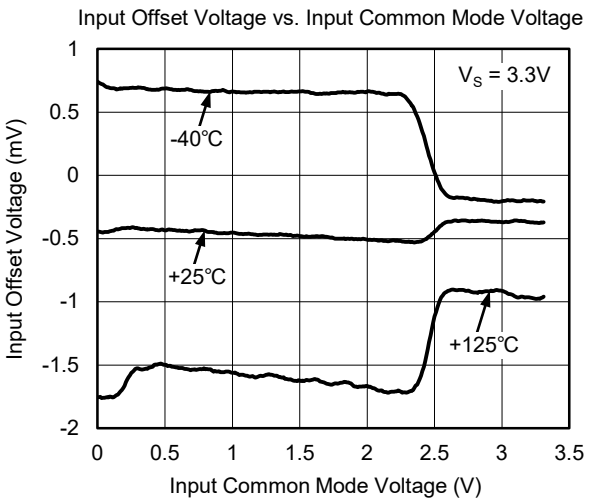
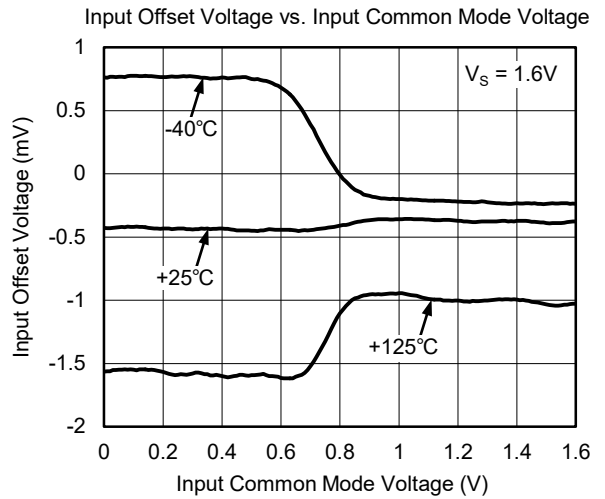
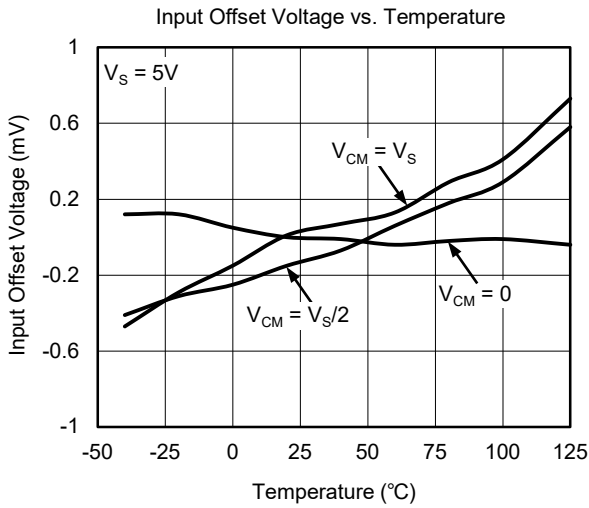
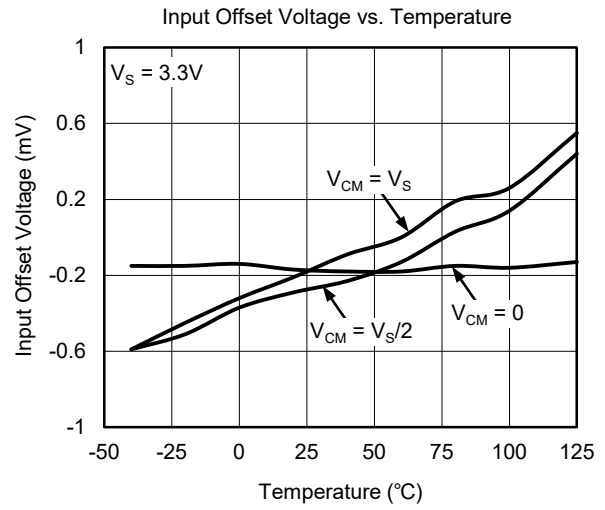
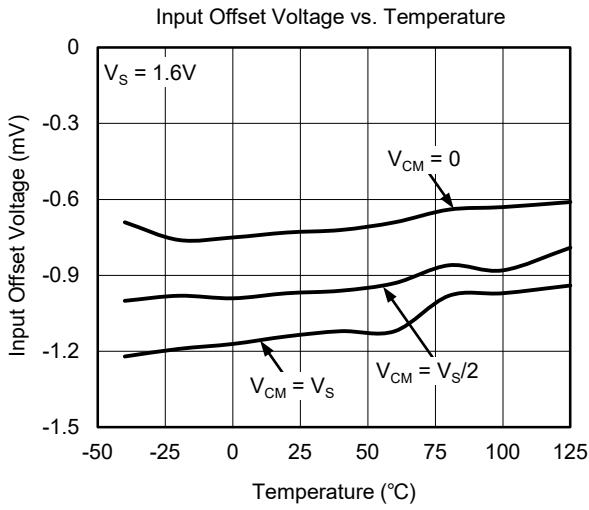

TYPICAL PERFORMANCE CHARACTERISTICS (continued)

At $T_A = +25^\circ\text{C}$, unless otherwise noted.

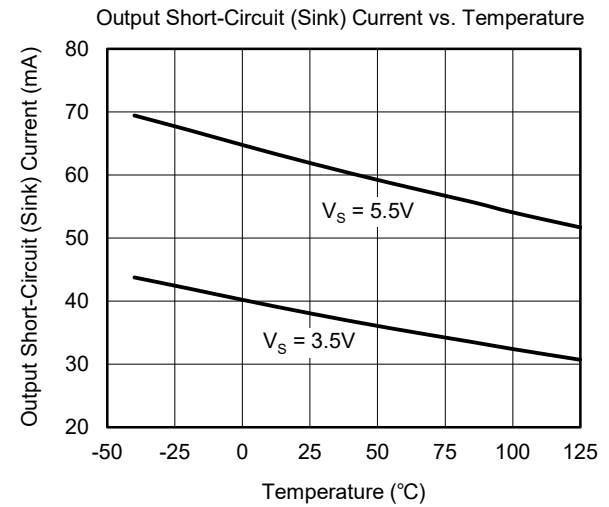
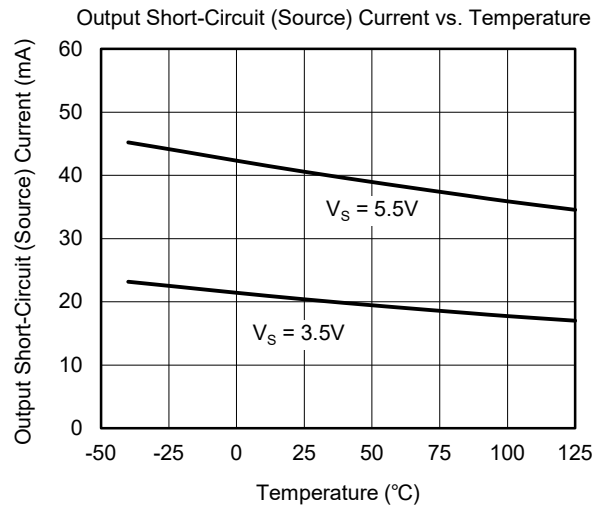
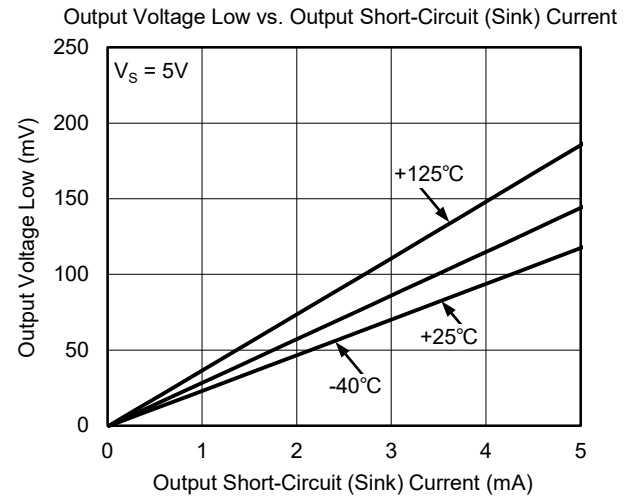
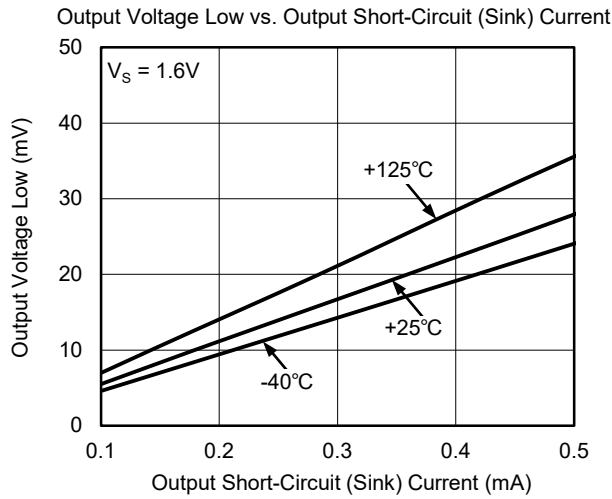
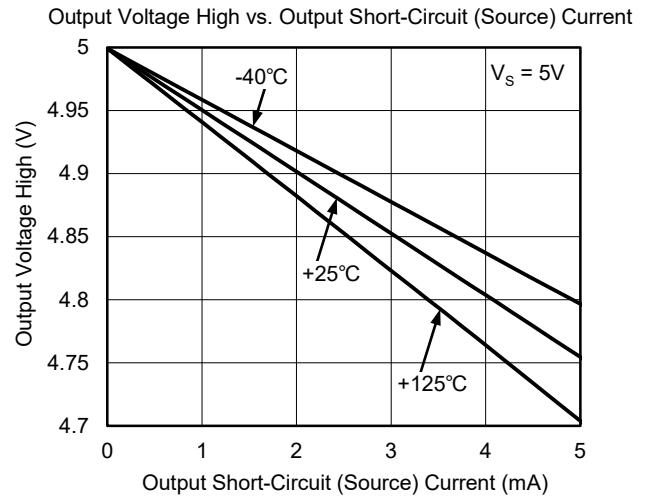
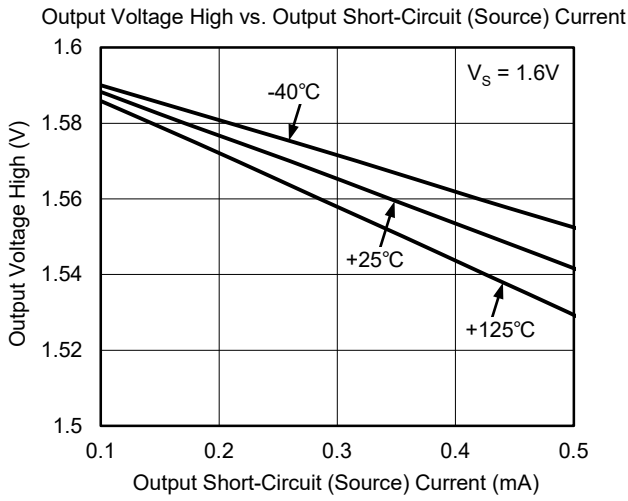

TYPICAL PERFORMANCE CHARACTERISTICS (continued)

At $T_A = +25^\circ\text{C}$, unless otherwise noted.

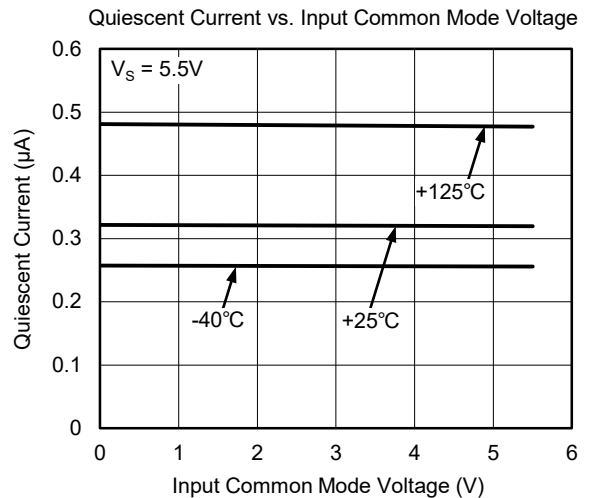
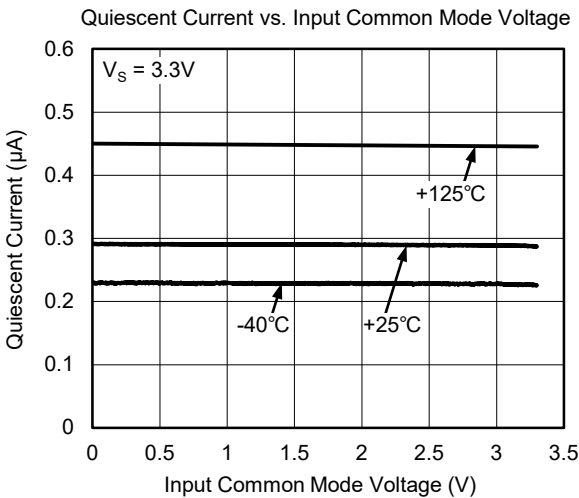
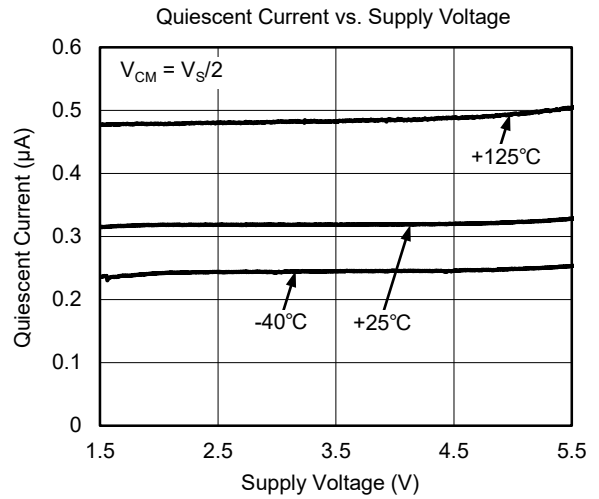
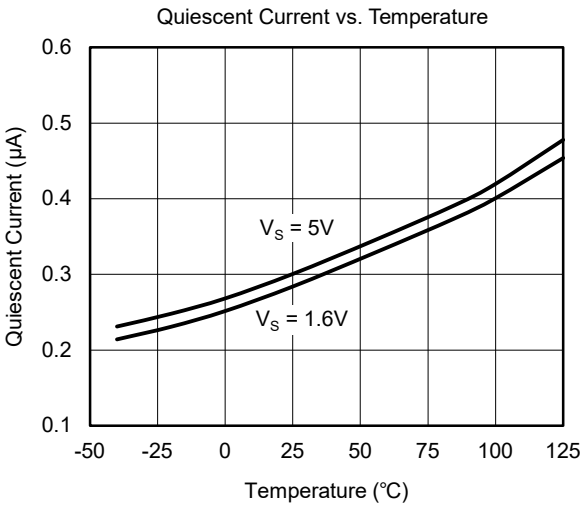
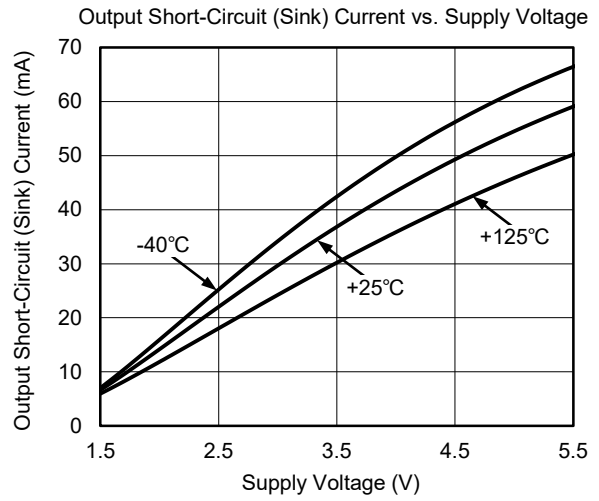
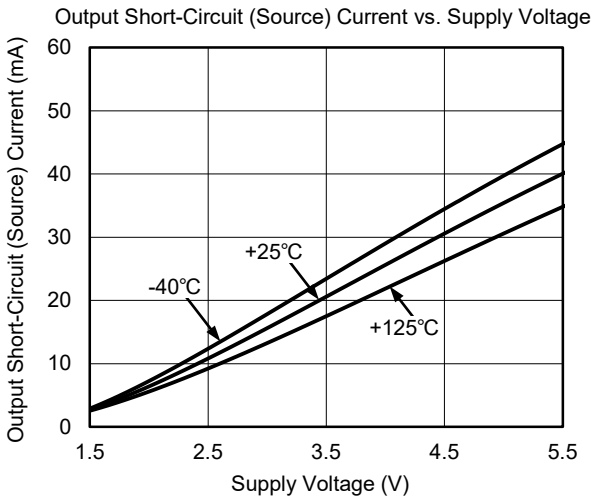

TYPICAL PERFORMANCE CHARACTERISTICS (continued)

At $T_A = +25^\circ\text{C}$, unless otherwise noted.

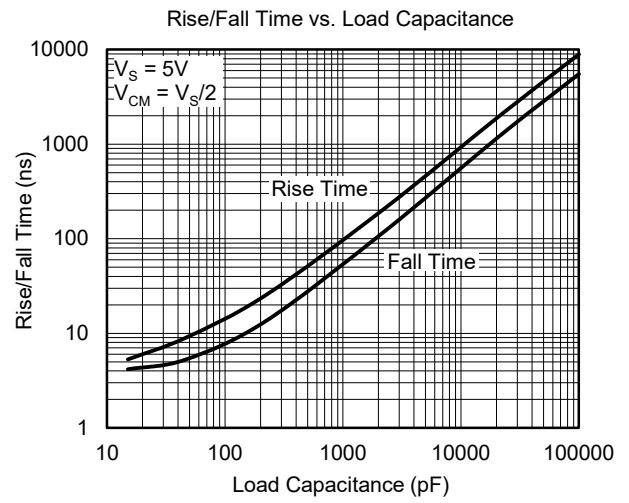
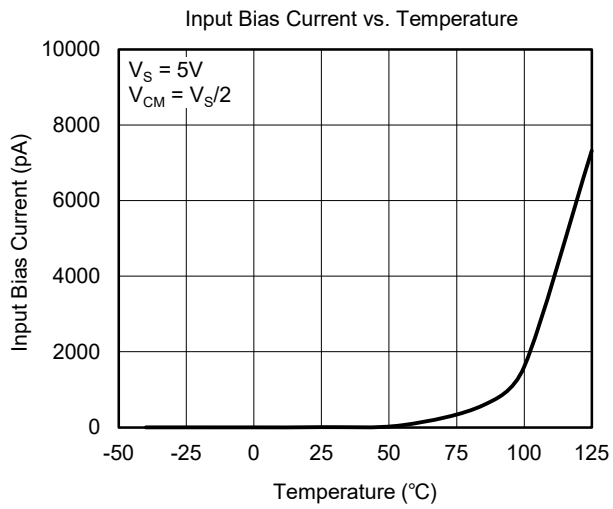

DETAILED DESCRIPTION

The SGM8714A-1 and SGM8714B-1 are single, nano-power, rail-to-rail input and small size comparators. They are optimized for low voltage operation from 1.6V to 5.5V single supply, consuming only 300nA quiescent current. The output stage of the comparator is open-drain and push-pull. Both devices are packaged in a space-saving XTDFN package, which makes them good choices for portable devices.

Device Function

Inputs

The maximum input common mode voltage range of the comparator is from $-V_S$ to V_S .

To protect the inputs of the comparator from going out of range, the internal diode connected to $-V_S$ is taken into account. To explain, the internal diode can be forward biased if the input voltage is below $-V_S$ and the input bias current of the comparator is increasing exponentially at this situation.

Output

To save the PCB space by eliminating the external open-drain resistor, the SGM8714A-1 provides the output stage of push-pull. Also, the SGM8714B-1 provides the output of open-drain for the specific applications.

Internal Hysteresis

The hysteresis curve is shown in Figure 2. The following three components are related to the hysteresis of the SGM8714A-1 and SGM8714B-1, which are V_{TH} , V_{OS} , and V_{HYST} .

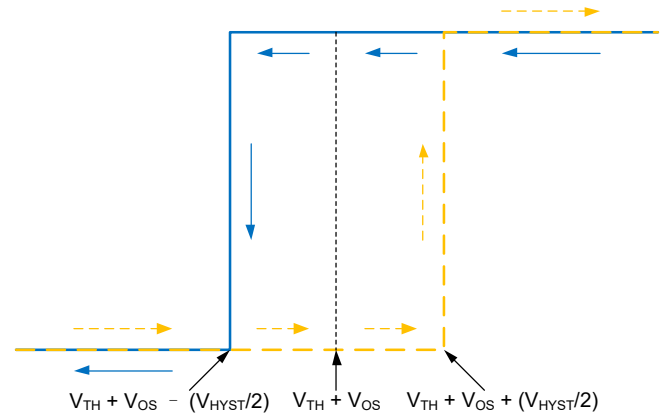

NOTES:

- V_{TH} is the trip voltage or set voltage of the comparator.
- V_{OS} is defined as the input offset voltage between V_{IN+} and V_{IN-} when $V_{OUT} = 0V$. This offset voltage is considered into the influence of the hysteresis which can affect the respond of the output.
- V_{HYST} is used to decrease the sensitivity to the noisy input voltage ($V_{HYST} = 6mV$ for both SGM8714A-1 and SGM8714B-1).

Figure 2. Hysteresis Transfer Curve

APPLICATION INFORMATION

The SGM8714A-1 and SGM8714B-1 are single, nano-power, rail to rail input and small size comparators. The above advantages make these comparators operated well in the battery-powered system. Also, the input rail-to-rail hysteresis can manage the input signal which is higher than the positive power supply with the internal hysteresis. The positive feedback should be taken into account for the applications of higher hysteresis. The power-budget can be reduced by the structure of push-pull for SGM8714A-1. The ability of open-drain for SGM8714B-1 is suitable for the condition of level shifting or wire-ORing.

Inverting Comparator with Hysteresis for SGM8714A-1

Figure 3 illustrates how SGM8714A-1 works with the external hysteresis. If the level of V_{IN} is lower than V_A , the V_{OUT} is in high position and it can be seen that $V_{OUT} = V_S$. For the special distribution of the feedback resistors, it can be seen as $R_1//R_2$ in series with R_3 . The

threshold (V_{A1}) of high-to-low transition is shown in Equation 1.

$$V_{A1} = V_S \times \frac{R_3}{(R_1 \parallel R_2) + R_3} \tag{1}$$

After V_{IN} reaches the level of V_{A1} and still increases, the level of V_{OUT} is in low position. For this situation, as the output voltage at this case is closed to GND, the feedback resistance network can be seen as R_1 in series with $R_2//R_3$. The threshold (V_{A2}) of low-to-high transition is shown in Equation 2.

$$V_{A2} = V_S \times \frac{R_2 \parallel R_3}{R_1 + (R_2 \parallel R_3)} \tag{2}$$

The hysteresis caused by the circuit is shown in Equation 3.

$$\Delta V_A = V_{A1} - V_{A2} \tag{3}$$

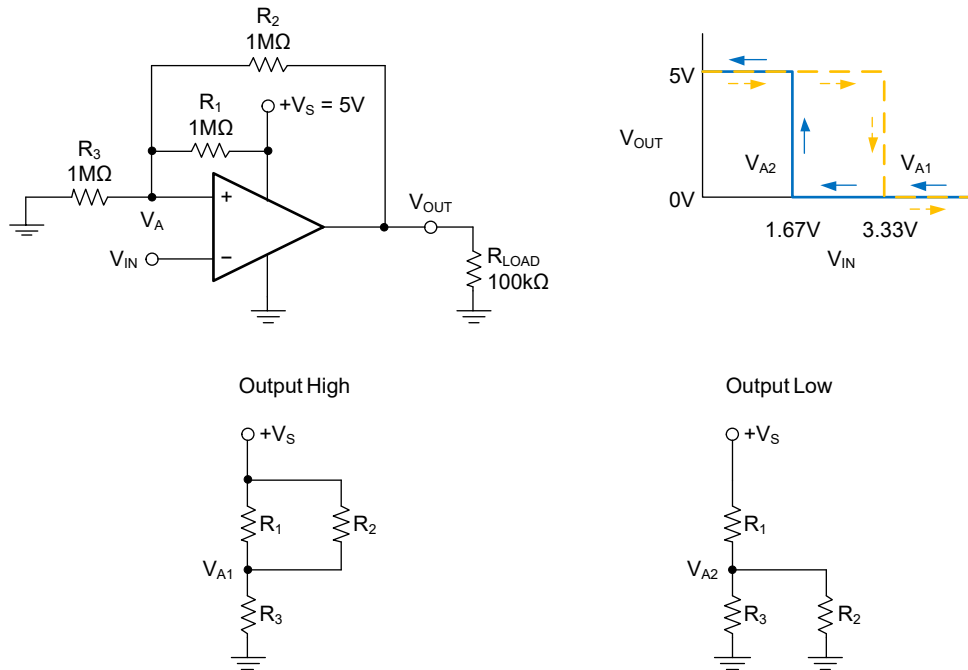

Figure 3. SGM8714A-1 in an Inverting Configuration with Hysteresis

APPLICATION INFORMATION (continued)

Non-Inverting Comparator with Hysteresis for SGM8714A-1

Figure 4 illustrates the non-inverting circuit with external hysteresis. To explain, the output remains in low position when the input of the circuit is below the threshold V_{IN1} . However, the output of the circuit will change to high position if the input voltage is larger than V_{IN1} . The value of V_{IN1} is shown as below:

$$V_{IN1} = R_1 \times \frac{V_{REF}}{R_2} + V_{REF} \tag{4}$$

As the increasing of V_{IN} , the output remains at high position. Moreover, if V_{IN} is lower than V_{IN2} , the output will go back to low state again. The value of V_{IN2} is shown as below:

$$V_{IN2} = \frac{V_{REF} \times (R_1 + R_2) - V_S \times R_1}{R_2} \tag{5}$$

The hysteresis caused by the non-inverting circuit is shown in Equation 6.

$$\Delta V_{IN} = V_S \times \frac{R_1}{R_2} \tag{6}$$

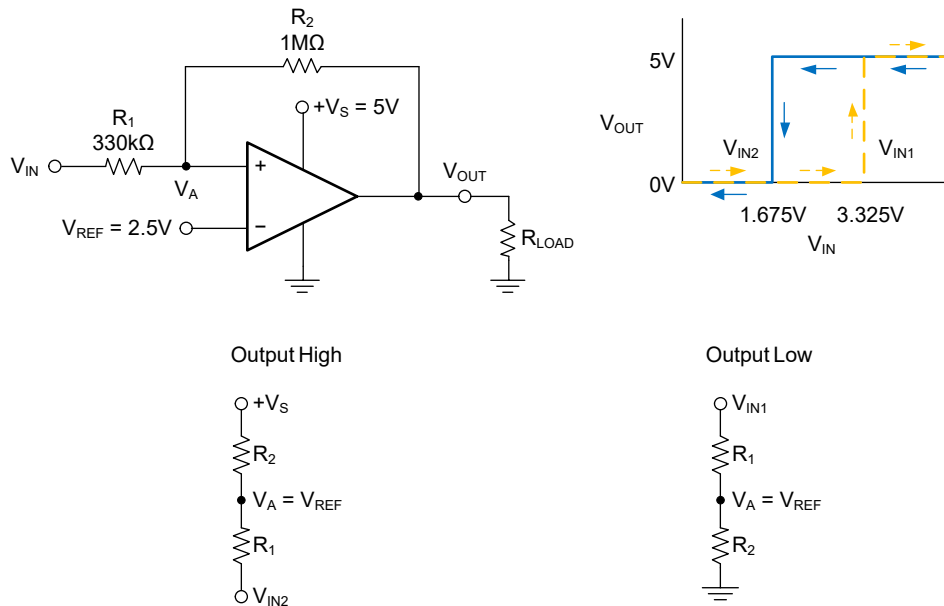

Figure 4. SGM8714A-1 in a Non-Inverting Configuration with Hysteresis

APPLICATION INFORMATION (continued)

Window Comparator

The application of window comparator of SGM8714B-1 is shown in Figure 5, and it is used for detecting the under-voltage or over-voltage situation.

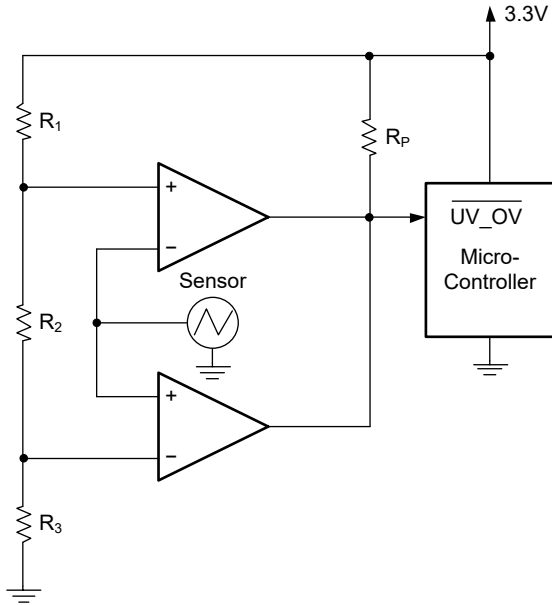

Figure 5. SGM8714B-1 Based Window Comparator

Design Requirements

The parameters of the above circuit are illustrated:

- ◆ The alert of logic low will be triggered if V_{IN} is lower than 1.1V.
- ◆ The alert of logic low will be triggered if V_{IN} is lower than 2.2V.
- ◆ The alert happens when the output of the circuit is low.
- ◆ Powered by 3.3V DC voltage.

Detailed Design Procedure

For the detail of SGM8714B-1, the pins of $+V_S$ and $-V_S$ are connected to +3.3V and GND respectively. Set the value of R_1 , R_2 and R_3 equals to $10M\Omega$ so that the two thresholds of the circuit are equals to +1.1V and +2.2V respectively. The reason for using large resistors is that the power consumption can be reduced dramatically. From the circuit in Figure 5, the output of the sensor is connected to the non-inverting and inverting inputs of the circuit respectively. The open-drain configuration of the outputs is used, and the two outputs are wire-ORed. If the level of input signal is lower than 1.1V or higher than 2.2V, the output of the circuit is in low state. Also, the output voltage remains high if the input voltage is within the range of 1.1V and 2.2V.

Application Curve

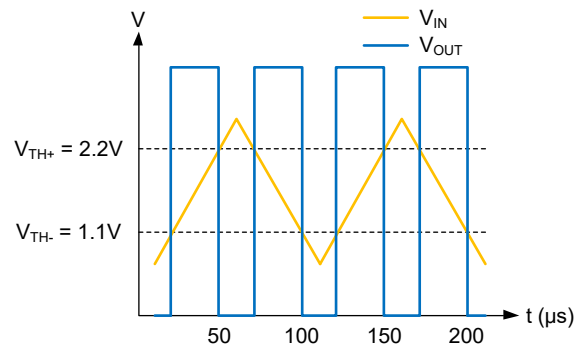

Figure 6. Window Comparator Results

APPLICATION INFORMATION (continued)

Square-Wave Oscillator

The following circuit is widely used for the applications of low-cost timing reference or clock source of the system.

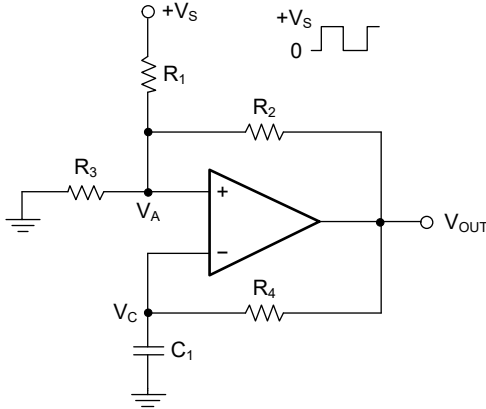

Figure 7. Square-Wave Oscillator

Design Requirements

For the circuit in Figure 7, the period of the square wave is determined by the time constant R_4C_1 . There are two parameters that limit the frequency of the square wave, which are the propagation delay of the comparator and the capacitance of the load. For a specific oscillation frequency, the feedback resistor R_4 can be larger when considering using small capacitor as the extreme low bias current of the input.

Detailed Design Procedure

The time constant R_4C_1 determines the oscillated frequency of the circuit.

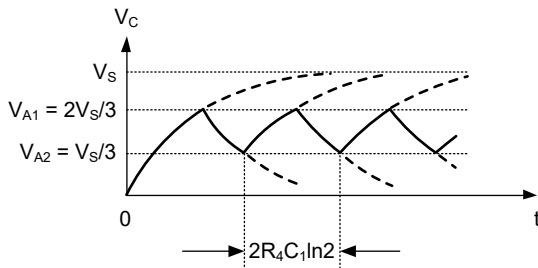

Figure 8. Square-Wave Oscillator Timing and Thresholds

To explain the operation of the circuit, first, it can be assumed that V_{OUT} is in high position. Then, the capacitor C_1 is charged by V_{OUT} at this stage until the value of V_C reaches the value of V_A . The following equation illustrates the threshold V_{A1} for the above case:

$$V_{A1} = \frac{V_S \times R_3}{R_3 + R_1 \parallel R_2}$$

$$V_{A1} = V_S \times \frac{R_2}{(R_1 \parallel R_3) + R_2} \tag{7}$$

If $R_1 = R_2 = R_3$, then $V_{A1} = 2V_S/3$.

Once the value of $V_C > V_{A1}$, the output of the comparator will be in low position (GND). The following equation illustrates the threshold V_{A2} :

$$V_{A2} = \frac{V_S \times (R_2 \parallel R_3)}{R_1 + R_2 \parallel R_3} \tag{8}$$

If $R_1 = R_2 = R_3$, then $V_{A2} = V_S/3$.

Once $V_A < V_C$, the capacitor C_1 will discharge until the value of V_C reaches the threshold V_{A2} . As the decreasing of V_C , the output will switch back to high position again. To calculate the time period of oscillation, it is considered as the value of V_C changes from $2V_S/3$ to $V_S/3$, and then goes back to $2V_S/3$ again, and the result equals to $2R_4C_1 \ln 2$. To calculate the frequency of oscillation, the equation is shown as below:

$$f = 1 / (2 \times R_4 \times C_1 \times \ln 2) \tag{9}$$

APPLICATION INFORMATION (continued)

Power Supply

In general, a single power supply ranged from 1.6V to 5.5V is recommended, the output of comparator is high ($V_{OUT} = V_S$) or low ($V_{OUT} = GND$). Sometimes, bipolar power supply is also used by SGM8714A-1 and SGM8714B-1 in level shifting application, for example, bipolar supply voltages of 2.5V and -2.5V are used for power comparators. If the bipolar mode of the comparator is taken into account, the logic high is V_S and logic low is $-V_S$ for this situation.

Power Supply Decoupling

It is recommended that the value of chosen bypass capacitor is equal to 100nF to improve the performance of the SGM8714A-1 and SGM8714B-1 for the situations of long trace, noisy and high output impedance of the power supply. Also, if the output of the comparator needs to drive capacitive load and long trace, the bypass capacitor is recommended as well. Because of the high ability of sinking or sourcing output current and high rise or fall edge rate at the output of the comparator, a decoupling capacitor connected to the power supply pin is necessary as the high demand of the current.

REVISION HISTORY

NOTE: Page numbers for previous revisions may differ from page numbers in the current version.

AUGUST 2023 – REV.A to REV.A.1	Page
Updated General Description section.....	1
Updated Absolute Maximum Ratings section.....	2

Changes from Original (MARCH 2021) to REV.A	Page
Changed from product preview to production data.....	All

PACKAGE OUTLINE DIMENSIONS

XTDFN-1x1-6L

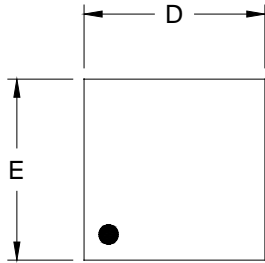

TOP VIEW

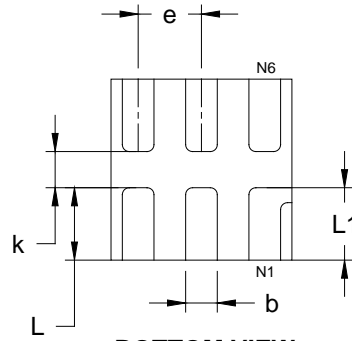

BOTTOM VIEW

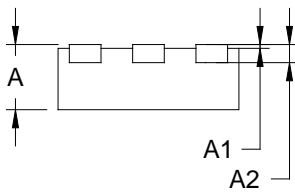

SIDE VIEW

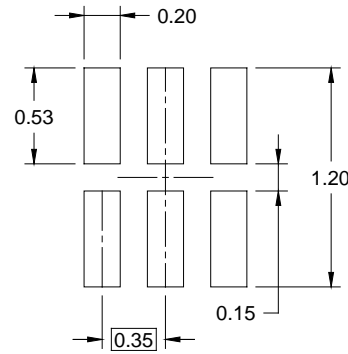

RECOMMENDED LAND PATTERN (Unit: mm)

Symbol	Dimensions In Millimeters		Dimensions In Inches	
	MIN	MAX	MIN	MAX
A	0.320	0.400	0.013	0.016
A1	0.000	0.050	0.000	0.002
A2	0.100 REF		0.004 REF	
D	0.950	1.050	0.037	0.041
E	0.950	1.050	0.037	0.041
k	0.150 MIN		0.006 MIN	
b	0.120	0.230	0.005	0.009
e	0.350 TYP		0.014 TYP	
L	0.350	0.450	0.014	0.018
L1	0.350	0.450	0.014	0.018

NOTE: This drawing is subject to change without notice.

PACKAGE INFORMATION

TAPE AND REEL INFORMATION

REEL DIMENSIONS



TAPE DIMENSIONS



NOTE: The picture is only for reference. Please make the object as the standard.

KEY PARAMETER LIST OF TAPE AND REEL

Package Type	Reel Diameter	Reel Width W1 (mm)	A0 (mm)	B0 (mm)	K0 (mm)	P0 (mm)	P1 (mm)	P2 (mm)	W (mm)	Pin1 Quadrant
XTDFN-1×1-6L	7"	9.5	1.16	1.16	0.50	4.0	2.0	2.0	8.0	Q1

000001

PACKAGE INFORMATION

CARTON BOX DIMENSIONS



NOTE: The picture is only for reference. Please make the object as the standard.

KEY PARAMETER LIST OF CARTON BOX

Reel Type	Length (mm)	Width (mm)	Height (mm)	Pizza/Carton
7" (Option)	368	227	224	8
7"	442	410	224	18

DD0002