

Step-Down Switching Regulator IC with Power Saving PWM/PFM control

■ GENERAL DESCRIPTION

The **NJU7631** is a low voltage operation high-speed switching regulator control IC for step-down converter, with PWM/PFM switching control. It can improve a switching efficiency on light load with automatically changing between PWM and PFM controls. It incorporates a totem pole output, which can drive an external MOS-FET easily. The NJU7631 also has a soft-start function, dead time control and timer latch for short circuit protection and their times are all adjustable with external parts. It is available in a small and thin 8-lead MSOP (TVSP) package.

■ FEATURES

- Automatic PWM/PFM Control
- Operating Voltage 2.2V to 8V
- Wide Oscillator Range 300kHz to 1MHz
- Maximum Duty Cycle 100%
- Quiescent Current 800 μ A typ.
- Soft-Start Function Internal : 16ms typ. or adjustable
- Dead Time Control
- Timer Latch for Short Circuit Protection
- C-MOS Technology
- Package Outline NJU7631RB1 : MSOP8 (TVSP8)*

*MEET JEDEC MO-187-DA/ THIN TYPE

■ PACKAGE OUTLINE



NJU7631RB1
(MSOP8 (TVSP8))

■ PRODUCT VARIATION

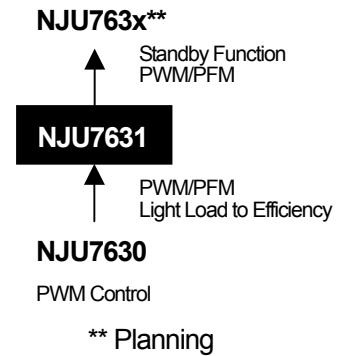

■ PIN CONFIGURATION

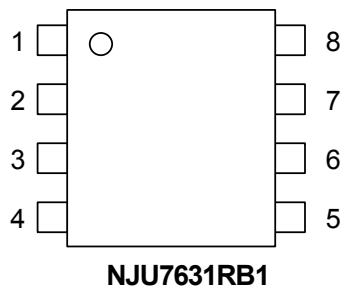

PIN FUNCTION

1. OUT
2. V⁺
3. FB
4. IN-
5. SCP
6. DTC
7. RT
8. GND

NJU7631

■ BLOCK DIAGRAM

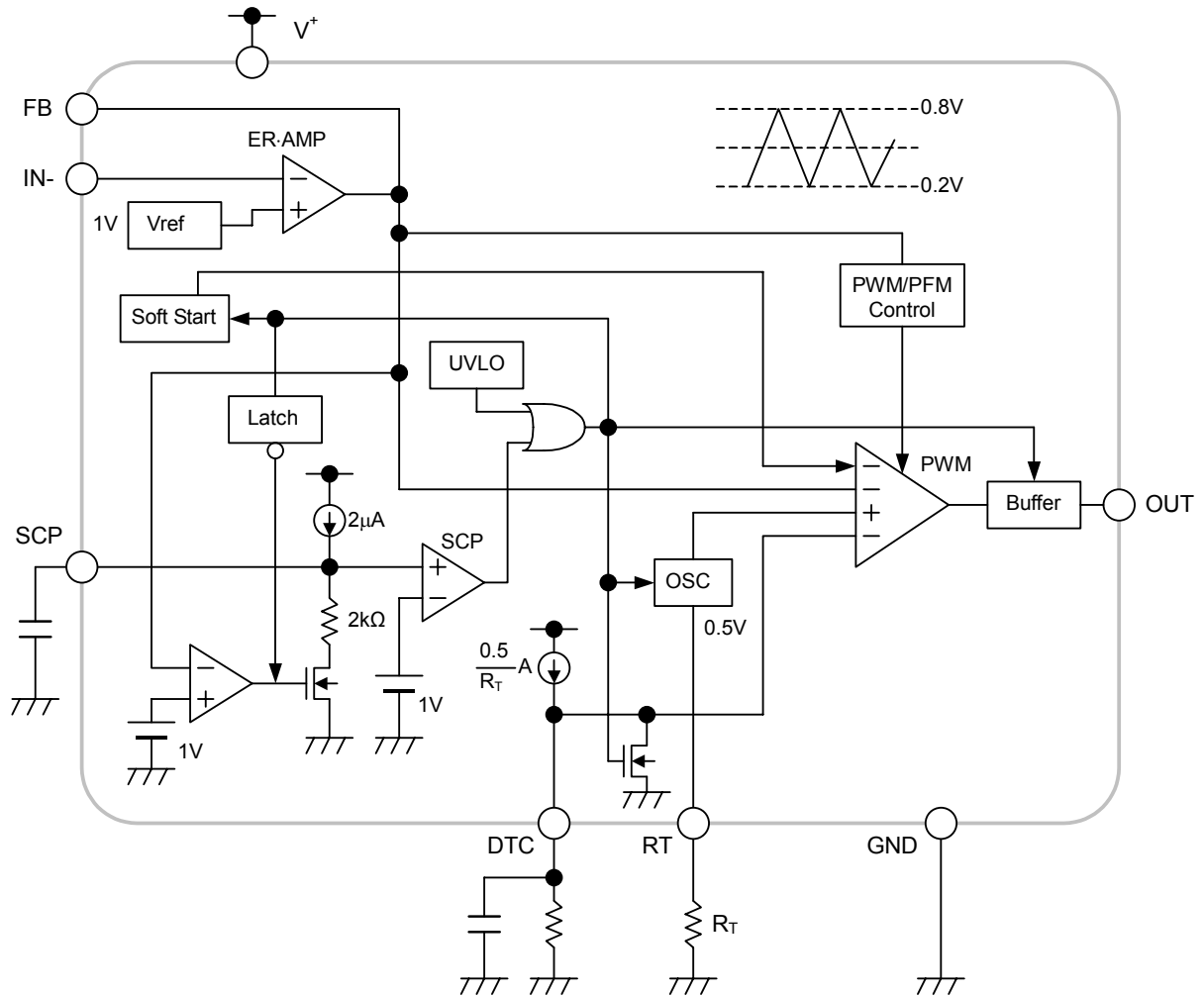

■ ABSOLUTE MAXIMUM RATINGS

(Ta=25°C)

PARAMETER	SYMBOL	MAXIMUM RATINGS	UNIT
Supply Voltage	V ⁺	+9	V
Output Pin Current	I _O	±50	mA
Power Dissipation	P _D	MSOP8 (TVSP8) :320	mW
Operating Temperature Range	T _{OPR}	-40 to +85	°C
Storage Temperature Range	T _{STG}	-40 to +125	°C

■ RECOMMENDED OPERATING CONDITIONS

(Ta=25°C)

PARAMETER	SYMBOL	MIN.	TYP.	MAX.	UNIT
Operating Voltage	V ⁺	2.2	–	8	V
Oscillator Timing Resistor	R _T	30	47	120	kΩ
Oscillation Frequency	f _{OSC}	300	700	1,000	kHz

■ ELECTRICAL CHARACTERISTICS

(V⁺=3.3V, R_T=47kΩ, Ta=25°C)

PARAMETER	SYMBOL	TEST CONDITION	MIN.	TYP.	MAX.	UNIT
Under Voltage Lockout Block						
ON Threshold Voltage	V _{T_ON}	V ⁺ = L → H	1.9	2.0	2.1	V
OFF Threshold Voltage	V _{T_OFF}	V ⁺ = H → L	1.8	1.9	2.0	V
Hysteresis Voltage	V _{HYS}		60	100	–	mV
Soft Start Block						
Soft Start Time	T _{SS}	V _{T_ON} → Duty=80%	8	16	24	ms
Short Circuit Protection Block						
Input Threshold Voltage	V _{T_PC}	FB Pin	0.95	1.00	1.05	V
Charge Current	I _{CHG}	V _{SCP} =0V	1.5	2	2.5	μA
Latch Mode ON Threshold Voltage	V _{T_LA}	SCP Pin	0.95	1.00	1.05	V
Latch Mode OFF Threshold Voltage	V _{T_LAOFF}	SCP Pin	0.2	0.45	0.7	V
Oscillator Block						
RT Pin Voltage	V _{RT}		-5%	0.5	+5%	V
Oscillation Frequency	f _{OSC}		630	700	770	kHz
Oscillate Supply Voltage Fluctuations	f _{DV}	V ⁺ =2.2V to 8V	–	1	–	%
Oscillate Temperature Fluctuations	f _{DT}	Ta=-40°C to +85°C	–	3	–	%

NJU7631

■ ELECTRICAL CHARACTERISTICS

($V^+=3.3V$, $R_T=47k\Omega$, $T_a=25^\circ C$)

PARAMETER	SYMBOL	TEST CONDITION	MIN.	TYP.	MAX.	UNIT
Error Amplifier Block						
Reference Voltage	V_B		-1.0%	1.00	+1.0%	V
Input Bias Current	I_B		-0.1	–	0.1	μA
Open Loop Gain	A_V		–	80	–	dB
Gain Bandwidth Product	G_B		–	1	–	MHz
Output Source Current	I_{OM+1}	$V_{FB}=1V$, $V_{IN-}=0.9V$	25	55	95	mA
	I_{OM+2}	$V_{FB}=1V$, $V_{IN-}=0.9V$, $V^+=2.2V$	4	9	16	mA
Output Sink Current	I_{OM-}	$V_{FB}=1V$, $V_{IN-}=1.1V$	0.10	0.16	0.22	mA
PWM Compare Block						
Input Threshold Voltage	V_{T25}	Duty= PFMD _{UTY}	0.29	0.35	0.41	V
	V_{T50}	Duty=50%	0.44	0.5	0.56	V
Maximum Duty Cycle	$M_{AXDUTY1}$	$V_{FB}=0.9V$	100	–	–	%
	$M_{AXDUTY2}$	$V_{FB}=0.9V$, $R_{DTC}=47k\Omega$	40	50	60	%
PWM/PFM Change Duty Cycle	PFMD _{UTY}		17	25	33	%
Output Block						
Output High Level ON Resistance	R_{OH}	$I_O=-20mA$	–	10	20	Ω
Output Low Level ON Resistance	R_{OL}	$I_O=+20mA$	–	5	10	Ω
General Characteristics						
Quiescent Current	I_{DD}	$R_L=Non\ Load$	–	800	1200	μA

■ TYPICAL APPLICATIONS

Step-Down Converter

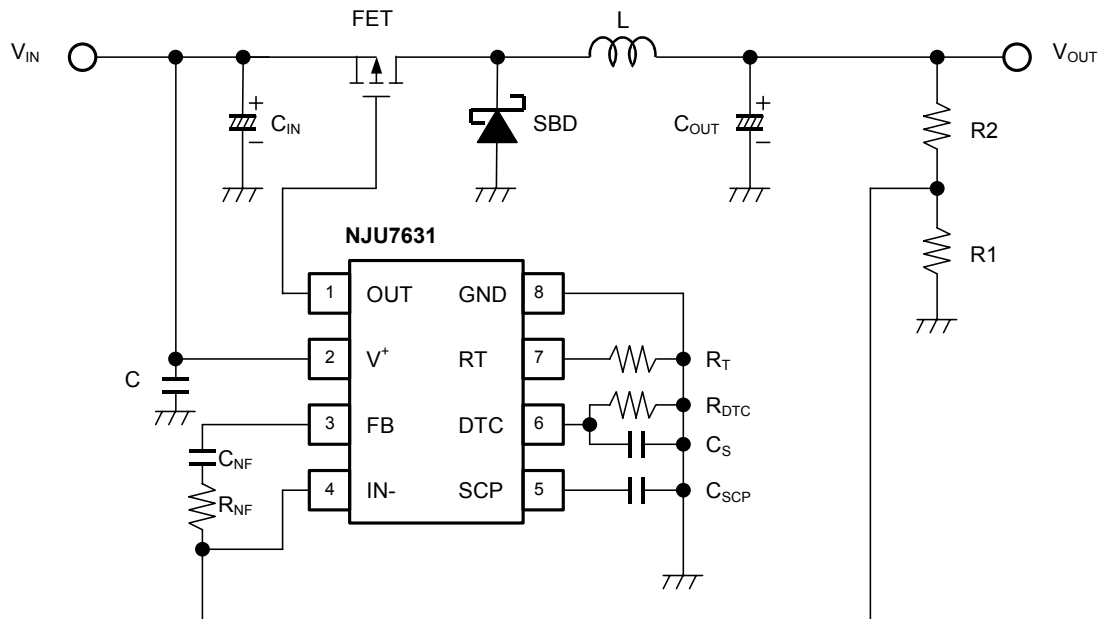

■ TYPICAL CHARACTERISTICS

Oscillation Frequency vs. Timing Resistance

($V^+ = 3.3V, T_a = 25^\circ C$)

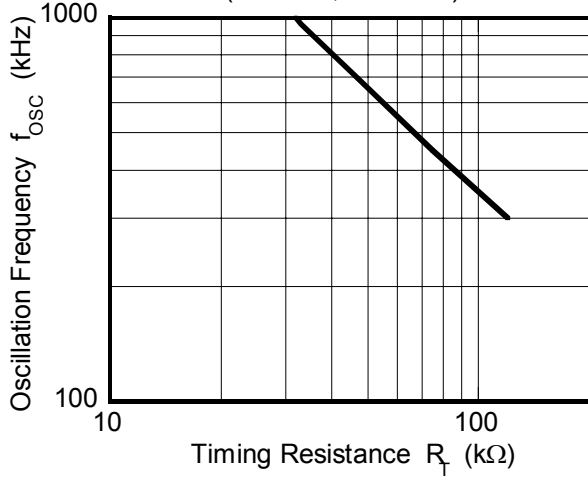

Oscillation Frequency vs. Operating Voltage

($R_T = 47k\Omega, T_a = 25^\circ C$)

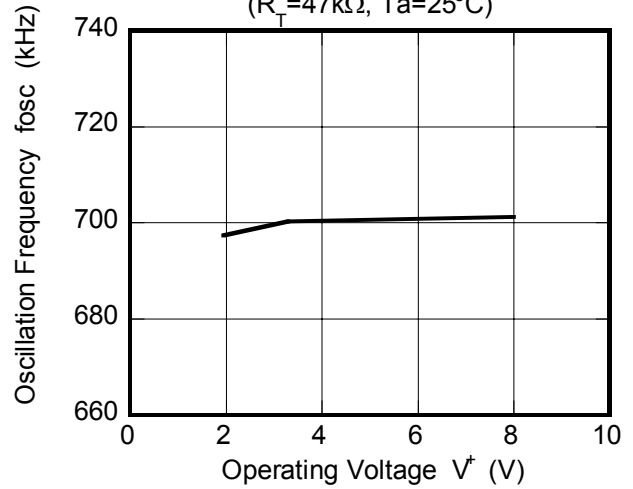

Duty Cycle vs. R_{DTC}

($V^+ = 3.3V, R_T = 47k\Omega, T_a = 25^\circ C$)

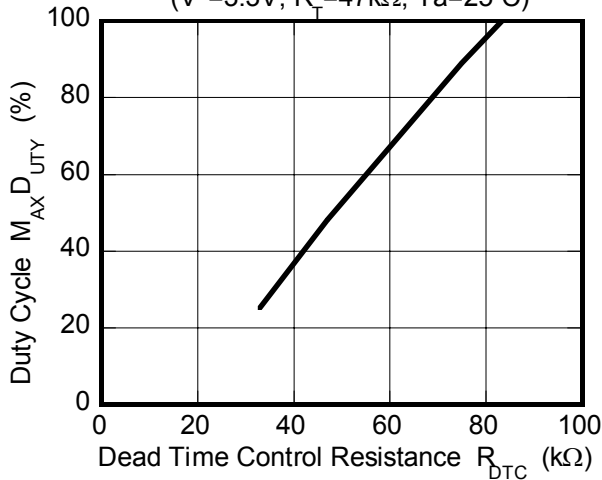

Reference Voltage vs. Operating Voltage

($T_a = 25^\circ C$)

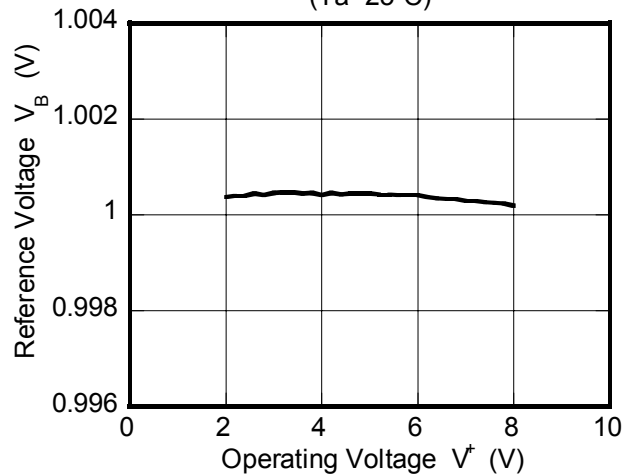

Quiescent Current vs. Operating Voltage

($R_T = 47k\Omega, R_L = \text{Non Load}, T_a = 25^\circ C$)

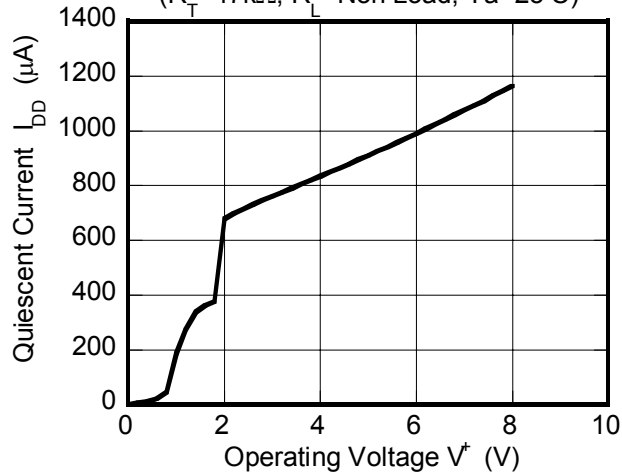

■ TYPICAL CHARACTERISTICS

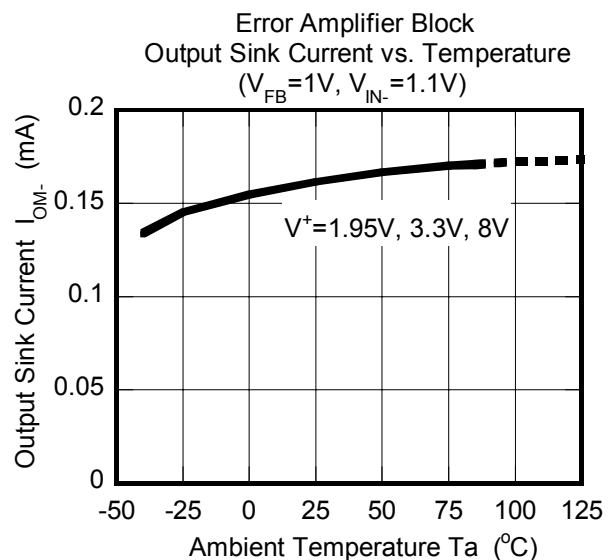
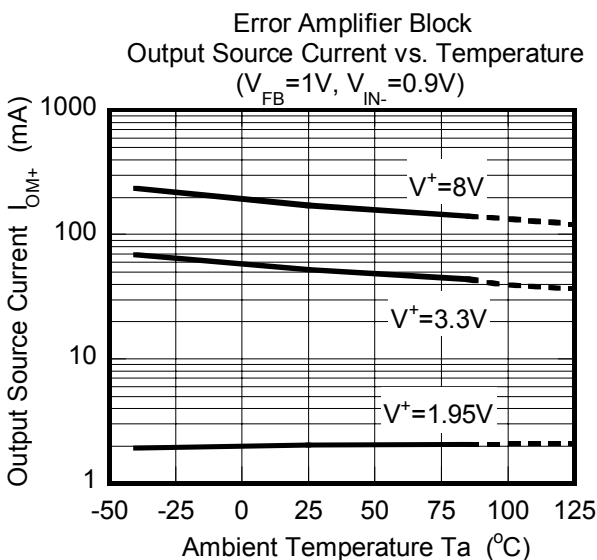
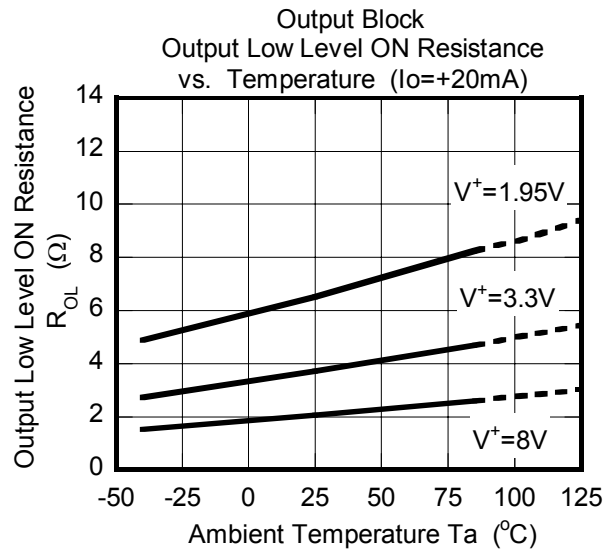
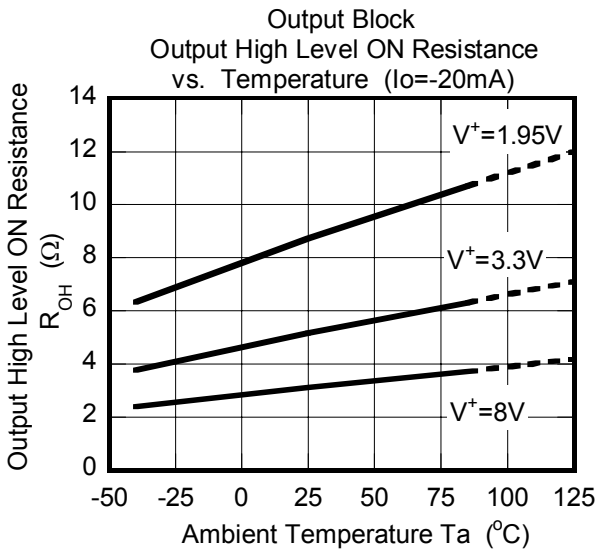
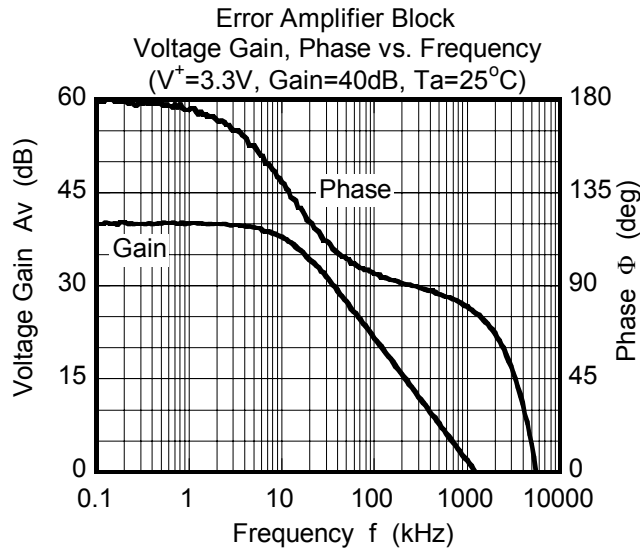

■ TYPICAL CHARACTERISTICS

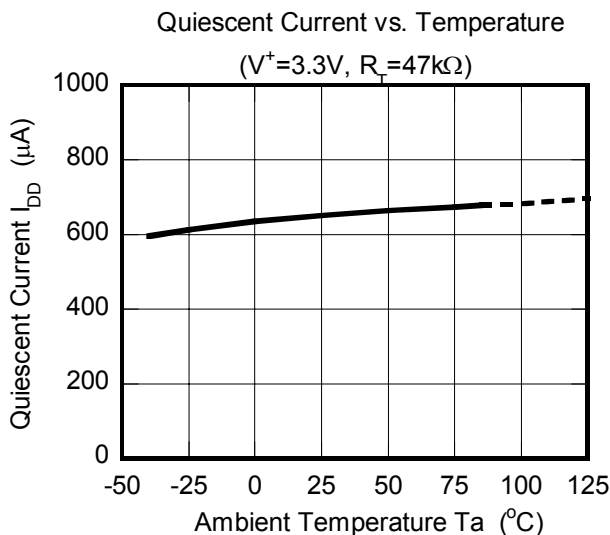
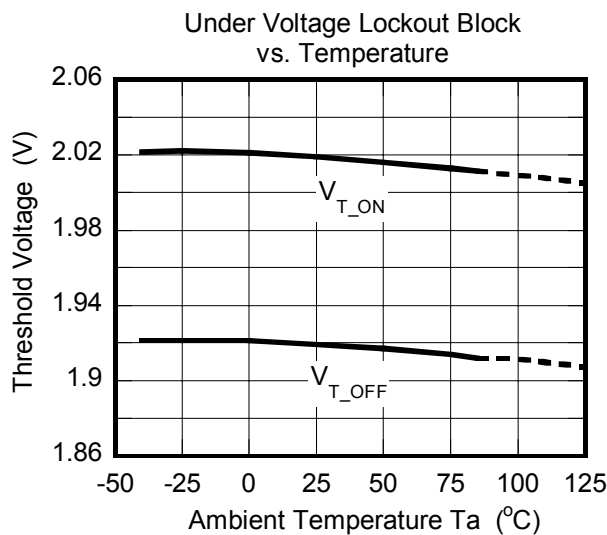
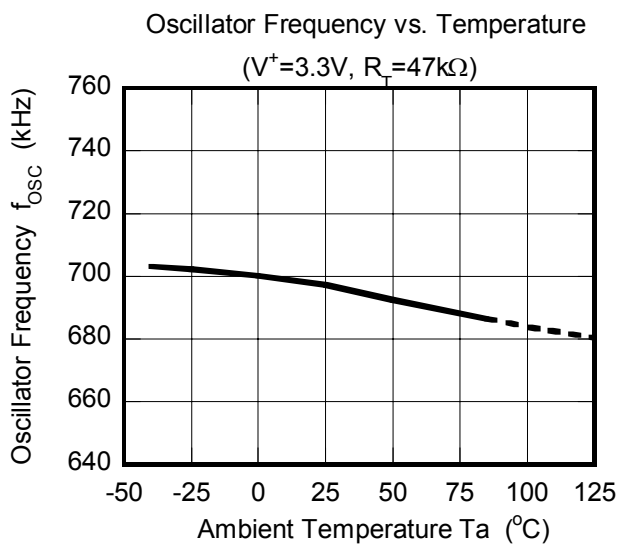
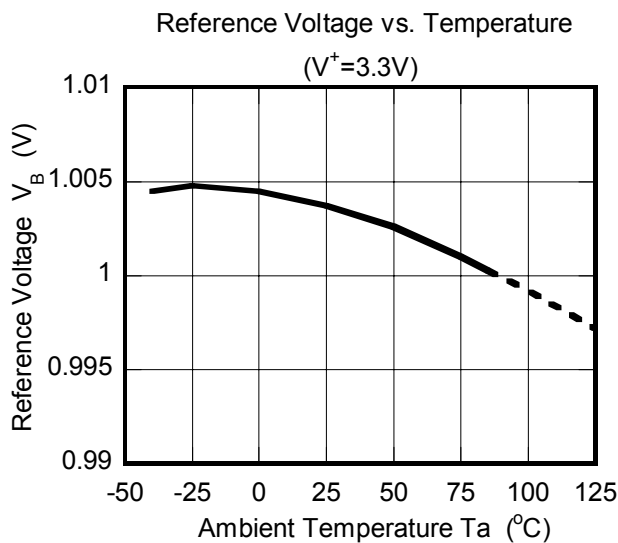
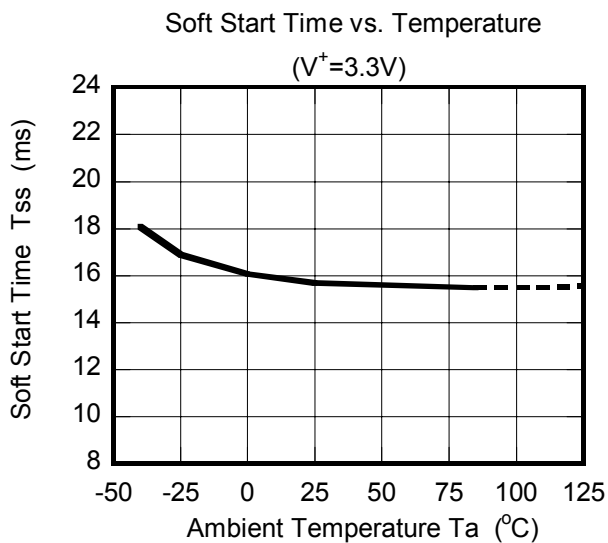

MEMO

[CAUTION]

The specifications on this databook are only given for information, without any guarantee as regards either mistakes or omissions. The application circuits in this databook are described only to show representative usages of the product and not intended for the guarantee or permission of any right including the industrial rights.