

## PRECISION, LOW NOISE, RAIL-TO-RAIL OUTPUT, EXCELLENT EMI IMMUNITY, CMOS OPERATIONAL AMPLIFIERS

### FEATURES

- High Precision
  - Low Input Offset Voltage
 

NJU7076 / NJU7077	150 $\mu$ V max.
NJU7078	200 $\mu$ V max.
  - Low Offset Voltage Drift
 

	0.5 $\mu$ V/ $^{\circ}$ C typ.
--	--------------------------------
- Low Noise
 

	10nV/ $\sqrt{\text{Hz}}$ typ.
--	-------------------------------
- Low Input Bias Current
 

	1pA typ.
--	----------
- Rail-to-Rail Output
 

$R_L=10\text{k}\Omega$	0.02V to 4.98V typ. ( $V^+=5\text{V}$ )
$R_L=600\Omega$	0.08V to 4.92V typ. ( $V^+=5\text{V}$ )
- Ground Sensing
- Integrated EMI Filter EMIRR=59dB typ. @f=900 MHz
- Operating Voltage
 

	2.2V to 5.5V
--	--------------
- Unity-Gain Stable
- Package
 

NJU7076	SOT-23-5
NJU7077	MSOP8 (VSP8)*
	*meet JEDEC MO-187-DA
NJU7078	SSOP14

### DESCRIPTION

The NJU7076/NJU7077/NJU7078 are single/dual/Quad channel, precision, low-noise, rail-to-rail output CMOS operational amplifiers. These devices featuring a low input offset voltage (50 $\mu$ V max.), low temperature drift (0.5 $\mu$ V/ $^{\circ}$ C typ.), and low bias current (1pA typ.). The combination of these specifications makes the devices well-suited for sensor applications such as temperature sensors, weight sensors, high-precision current sensing amplifiers, and current-voltage converters.

The output swing can reach 20 mV from the rails while driving a 10k $\Omega$  load (at 5V operation). Input voltage includes ground, enabling direct sensing near ground.

The NJU7076/NJU7077/NJU7078 have high EMI immunity to reduce malfunctions, making them ideal for EMI-sensitive applications.

### APPLICATIONS

- Thermocouple / Thermopile Amplifiers
- Strain Gauge / Pressure Sensor Amplifiers
- Load Cell and Bridge Transducer Amplifiers
- High-Resolution Data Acquisition
- Precision Current Sensing
- Battery Monitoring
- Photodiode Amplifiers

### ■ TYPICAL CHARACTERISTICS

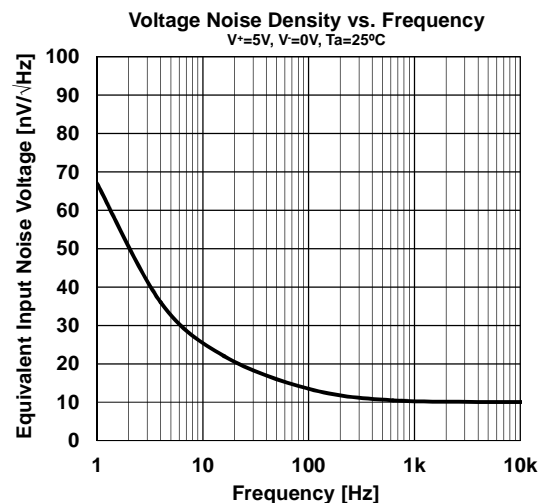
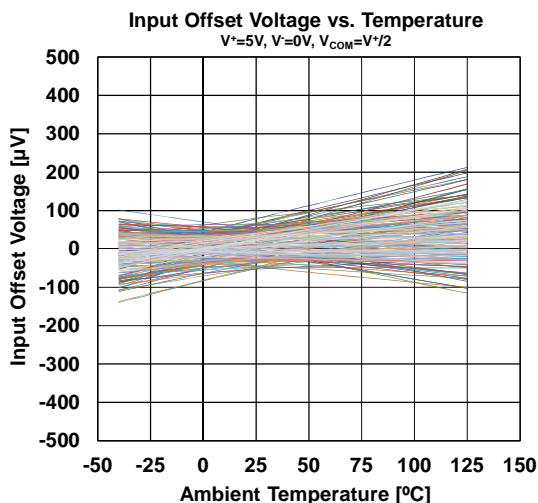

## ■ PIN CONFIGURATIONS

PRODUCT NAME	NJU7076F	NJU7077R
Package	SOT-23-5	MSOP8 (VSP8)
Pin Functions	<p>(Top View)</p> <p>OUTPUT 1, V<sup>-</sup> 2, +INPUT 3, -INPUT 4, V<sup>+</sup> 5</p>	<p>(Top View)</p> <p>A OUTPUT 1, A -INPUT 2, A +INPUT 3, V<sup>-</sup> 4, B +INPUT 5, B -INPUT 6, B OUTPUT 7, V<sup>+</sup> 8</p>
PRODUCT NAME	NJU7078V	
Package	SSOP14	
Pin Functions	<p>(Top View)</p> <p>A OUTPUT 1, A -INPUT 2, A +INPUT 3, V<sup>+</sup> 4, B +INPUT 5, B -INPUT 6, B OUTPUT 7, C OUTPUT 8, C -INPUT 9, C +INPUT 10, V<sup>-</sup> 11, D +INPUT 12, D -INPUT 13, D OUTPUT 14</p>	

## ■ PRODUCT NAME INFORMATION

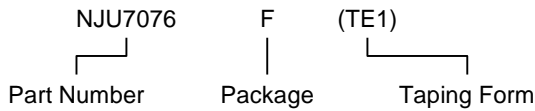

## ■ ORDER INFORMATION

PRODUCT NAME	PACKAGE	RoHS	HALOGEN-FREE	TERMINAL FINISH	MARKING	WEIGHT (mg)	MOQ (pcs)
NJU7076F	SOT-23-5	Yes	Yes	Sn2Bi	11D	15	3000
NJU7077R	MSOP8 (VSP8)	Yes	Yes	Sn2Bi	7077	21	2000
NJU7078V	SSOP14	Yes	Yes	Sn2Bi	7078	65	2000

## ■ ABSOLUTE MAXIMUM RATINGS

PARAMETER	SYMBOL	RATING	UNIT
Supply Voltage	$V^+ - V^-$	7	V
Differential Input Voltage <sup>(1)</sup>	$V_{ID}$	$\pm 7$ <sup>(2)</sup>	V
Input Voltage	$V_{IN}$	$V^- - 0.3$ to $V^+ + 0.3$ <sup>(3)</sup>	V
Power Dissipation ( $T_a = 25^\circ\text{C}$ )	$P_D$	2-Layer / 4-Layer <sup>(4)</sup>	
SOT-23-5		480 / 650	mW
MSOP8 (VSP8)		500 / 660	
SSOP14		555 / 690	
Storage Temperature Range	$T_{stg}$	-55 to 150	$^\circ\text{C}$
Maximum Junction Temperature	$T_{jmax}$	150	$^\circ\text{C}$

## ■ THERMAL CHARACTERISTICS

PACKAGE	SYMBOL	VALUE	UNIT
Junction-to-Ambient Thermal Resistance	$\theta_{ja}$	2-Layer / 4-Layer <sup>(4)</sup>	
SOT-23-5		260 / 192	$^\circ\text{C}/\text{W}$
MSOP8 (VSP8)		250 / 189	
SSOP14		225 / 181	
Junction-to-Top of Package Characterization Parameter	$\psi_{jt}$	2-Layer / 4-Layer <sup>(4)</sup>	
SOT-23-5		67 / 58	$^\circ\text{C}/\text{W}$
MSOP8 (VSP8)		62 / 53	
SSOP14		53 / 52	

(1) Differential voltage is the voltage difference between +INPUT and -INPUT.

(2) For supply voltage less than 7V, the absolute maximum rating is equal to the supply voltage.

(3) The absolute maximum input voltage is limited at 7V.

(4) 2-Layer: Mounted on glass epoxy board. (76.2x114.3x1.6 mm: based on EIA/JDEC standard, 2-layer FR-4)

4-Layer: Mounted on glass epoxy board. (76.2x114.3x1.6 mm: based on EIA/JDEC standard, 4-layer FR-4), internal Cu area: 74.2 x 74.2 mm

## ■ POWER DISSIPATION vs. AMBIENT TEMPERATURE

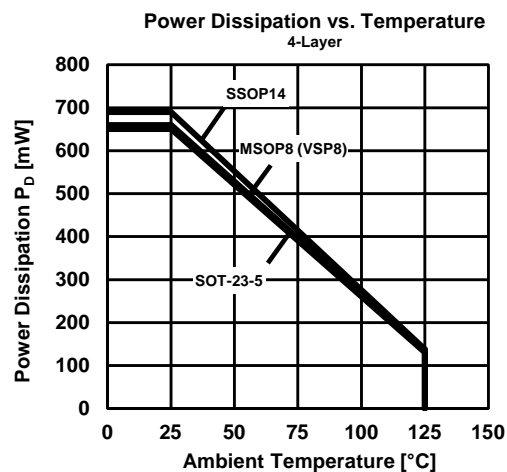
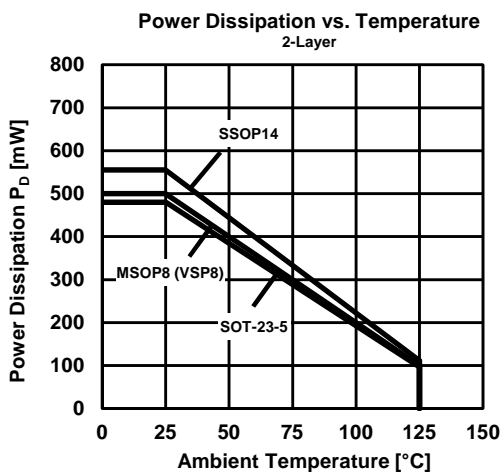

## ■ RECOMMENDED OPERATING CONDITIONS

PARAMETER	SYMBOL	CONDITIONS	VALUE	UNIT
Supply Voltage	$V^+ - V^-$	$T_a = 25^\circ\text{C}$	2.2 to 5.5	V
Operating Temperature Range	$T_{opr}$		-40 to 125	$^\circ\text{C}$

■ **ELECTRICAL CHARACTERISTICS** ( $V^+=5V$ ,  $V^- = 0V$ ,  $V_{COM}=V^+/2$ ,  $T_a=25^\circ C$ , unless otherwise noted.)

PARAMETER	SYMBOL	TEST CONDITIONS	MIN	TYP	MAX	UNIT
<b>DC CHARACTERISTICS</b>						
Input Offset Voltage NJU7076 / NJU7077	$V_{IO}$	$T_a=-40^\circ C$ to $125^\circ C$	-	20	150	$\mu V$
NJU7078			-	-	400	
			-	20	200	
		$T_a=-40^\circ C$ to $125^\circ C$	-	-	400	
Input Offset Voltage Drift	$\Delta V_{IO}/\Delta T$	$T_a=-40^\circ C$ to $125^\circ C$ <sup>(5)</sup>	-	0.5	5	$\mu V/^\circ C$
Input Bias Current	$I_B$		-	1	-	pA
Input Offset Current	$I_{IO}$		-	1	-	pA
Open-Loop Voltage Gain	$A_v$	$V_o=0.5V$ to $4.5V$ , $R_L=10k\Omega$ to $2.5V$ $V_o=0.5V$ to $4.5V$ , $R_L=10k\Omega$ to $2.5V$ , $T_a= -40^\circ C$ to $125^\circ C$	100 100	130 -	- -	dB
Common-Mode Rejection Ratio	CMR	$V_{ICM}=0V$ to $4V$ $V_{ICM}=0V$ to $4V$ , $T_a= -40^\circ C$ to $125^\circ C$	70 70	90 -	- -	dB
Supply Voltage Rejection Ratio	SVR	$V^+=2.2V$ to $5.5V$ $V^+=2.2V$ to $5.5V$ , $T_a= -40^\circ C$ to $125^\circ C$	70 70	90 -	- -	dB
High-level Output Voltage	$V_{OH}$	$R_L=10k\Omega$ to $2.5V$ $R_L=10k\Omega$ to $2.5V$ , $T_a= -40^\circ C$ to $125^\circ C$ $R_L=600\Omega$ to $2.5V$ $R_L=600\Omega$ to $2.5V$ , $T_a= -40^\circ C$ to $125^\circ C$ $I_{SOURCE}=2mA$ $I_{SOURCE}=2mA$ , $T_a= -40^\circ C$ to $125^\circ C$	4.95 4.95 4.85 4.85 4.9 4.85	4.98 - 4.92 - 4.96 -	- - - - - -	V
Low-level Output Voltage	$V_{OL}$	$R_L=10k\Omega$ to $2.5V$ $R_L=10k\Omega$ to $2.5V$ , $T_a= -40^\circ C$ to $125^\circ C$ $R_L=600\Omega$ to $2.5V$ $R_L=600\Omega$ to $2.5V$ , $T_a= -40^\circ C$ to $125^\circ C$ $I_{SINK}=2mA$ $I_{SINK}=2mA$ , $T_a= -40^\circ C$ to $125^\circ C$	- - - - - -	0.02 - 0.08 - 0.04 -	0.05 0.05 0.15 0.2 0.1 0.15	V
Common-Mode Input Voltage Range	$V_{ICM}$	CMR $\geq$ 70dB CMR $\geq$ 70dB, $T_a= -40^\circ C$ to $125^\circ C$	0 0	- -	4 4	V
Supply Current (All Amplifiers) NJU7076	$I_{SUPPLY}$	No Signal No Signal, $T_a = -40^\circ C$ to $125^\circ C$	-	0.6	0.9	mA
NJU7077			-	-	0.9	
			-	1.2	1.8	
NJU7078			-	-	1.8	
			-	2.3	3.5	
		No Signal, $T_a = -40^\circ C$ to $125^\circ C$	-	-	3.5	
<b>AC CHARACTERISTICS</b>						
Gain Bandwidth Product	GBW	$G_v=40dB$ , $R_F=100k\Omega$ , $R_L=10k\Omega$ to $2.5V$ , $C_L=20pF$ , $f=100kHz$	-	1.3	-	MHz
Phase Margin	$\Phi_m$	$G_v=40dB$ , $R_F=100k\Omega$ , $R_L=10k\Omega$ to $2.5V$ , $C_L=20pF$	-	60	-	deg
Gain Margin	$G_m$	$G_v=40dB$ , $R_F=100k\Omega$ , $R_L=10k\Omega$ to $2.5V$ , $C_L=20pF$	-	12	-	dB
Equivalent Input Noise Voltage	$e_n$	$f=1kHz$	-	10	-	$nV/\sqrt{Hz}$
Slew Rate	SR	$G_v=0dB$ , $R_L=10k\Omega$ to $2.5V$ , $C_L=20pF$ , $V_{IN}=3V_{PP}$	-	0.5	-	$V/\mu s$
Total Harmonic Distortion + Noise	THD+N	$G_v=20dB$ , $R_L=10k\Omega$ to $2.5V$ , $f=1kHz$ , $V_O=3V_{PP}$	-	0.01	-	%
Channel Separation	CS	$f=1kHz$ , NJU7077 / NJU7078	-	140	-	dB

(5) Guaranteed by two points of Temperature  $-40^\circ C$  and  $125^\circ C$

■ **ELECTRICAL CHARACTERISTICS** ( $V^+=2.2V$ ,  $V^-=0V$ ,  $V_{COM}=V^+/2$ ,  $T_a=25^\circ C$ , unless otherwise noted.)

PARAMETER	SYMBOL	TEST CONDITIONS	MIN	TYP	MAX	UNIT
<b>DC CHARACTERISTICS</b>						
Input Offset Voltage NJU7076 / NJU7077	$V_{IO}$	$T_a = -40^\circ C$ to $125^\circ C$	-	60	250	$\mu V$
NJU7078			-	-	400	
			-	60	300	
		$T_a = -40^\circ C$ to $125^\circ C$	-	-	400	
Input Offset Voltage Drift	$\Delta V_{IO}/\Delta T$	$T_a = -40^\circ C$ to $125^\circ C$ (5)	-	0.6	5	$\mu V/^\circ C$
Input Bias Current	$I_B$		-	1	-	pA
Input Offset Current	$I_{IO}$		-	1	-	pA
Open-Loop Voltage Gain	$A_v$	$V_o=0.6V$ to $1.6V$ , $R_L=10k\Omega$ to $1.1V$ , $V_o=0.6V$ to $1.6V$ , $R_L=10k\Omega$ to $1.1V$ , $T_a = -40^\circ C$ to $125^\circ C$	100	130	-	dB
			100	-	-	
Common-Mode Rejection Ratio	CMR	$V_{ICM}=0V$ to $1.2V$ $V_{ICM}=0V$ to $1.2V$ , $T_a = -40^\circ C$ to $125^\circ C$	70	90	-	dB
			70	-	-	
High-level Output Voltage	$V_{OH}$	$R_L=10k\Omega$ to $1.1V$	2.15	2.18	-	V
		$R_L=10k\Omega$ to $1.1V$ , $T_a = -40^\circ C$ to $125^\circ C$	2.15	-	-	
		$R_L=600\Omega$ to $1.1V$	2.1	2.14	-	
		$R_L=600\Omega$ to $1.1V$ , $T_a = -40^\circ C$ to $125^\circ C$	2.05	-	-	
		$I_{SOURCE}=2mA$ $I_{SOURCE}=2mA$ , $T_a = -40^\circ C$ to $125^\circ C$	2.05	2.13	-	
			2	-	-	
Low-level Output Voltage	$V_{OL}$	$R_L=10k\Omega$ to $1.1V$	-	0.02	0.05	V
		$R_L=10k\Omega$ to $1.1V$ , $T_a = -40^\circ C$ to $125^\circ C$	-	-	0.05	
		$R_L=600\Omega$ to $1.1V$	-	0.06	0.1	
		$R_L=600\Omega$ to $1.1V$ , $T_a = -40^\circ C$ to $125^\circ C$	-	-	0.15	
		$I_{SINK}=2mA$ $I_{SINK}=2mA$ , $T_a = -40^\circ C$ to $125^\circ C$	-	0.07	0.15	
			-	-	0.2	
Common-Mode Input Voltage Range	$V_{ICM}$	CMR $\geq$ 70dB CMR $\geq$ 70dB, $T_a = -40^\circ C$ to $125^\circ C$	0	-	1.2	V
			0	-	1.2	
Supply Current (All Amplifiers) NJU7076	$I_{SUPPLY}$	No Signal	-	0.55	0.82	mA
		No Signal, $T_a = -40^\circ C$ to $125^\circ C$	-	-	0.82	
NJU7077		No Signal	-	1.0	1.5	
		No Signal, $T_a = -40^\circ C$ to $125^\circ C$	-	-	1.5	
NJU7078		No Signal	-	2.0	3.0	
	No Signal, $T_a = -40^\circ C$ to $125^\circ C$	-	-	3.0		
<b>AC CHARACTERISTICS</b>						
Gain Bandwidth Product	GBW	$G_V=40dB$ , $R_F=100k\Omega$ , $R_L=10k\Omega$ to $1.1V$ , $C_L=20pF$ , $f=100kHz$	-	1.2	-	MHz
Phase Margin	$\Phi_m$	$G_V=40dB$ , $R_F=100k\Omega$ , $R_L=10k\Omega$ to $1.1V$ , $C_L=20pF$	-	60	-	deg
Gain Margin	$G_m$	$G_V=40dB$ , $R_F=100k\Omega$ , $R_L=10k\Omega$ to $1.1V$ , $C_L=20pF$	-	12	-	dB
Equivalent Input Noise Voltage	$e_n$	$f=1kHz$	-	10	-	$nV/\sqrt{Hz}$
Slew Rate	SR	$G_V=0dB$ , $R_L=10k\Omega$ to $1.1V$ , $C_L=20pF$ , $V_{IN}=1V_{PP}$	-	0.5	-	$V/\mu s$
Total Harmonic Distortion + Noise	THD+N	$G_V=20dB$ , $R_L=10k\Omega$ to $1.1V$ , $f=1kHz$ , $V_O=1V_{PP}$	-	0.01	-	%
Channel Separation	CS	$f=1kHz$ , NJU7077 / NJU7078	-	140	-	dB

(5) Guaranteed by two points of Temperature  $-40^\circ C$  and  $125^\circ C$

## ■ TYPICAL CHARACTERISTICS

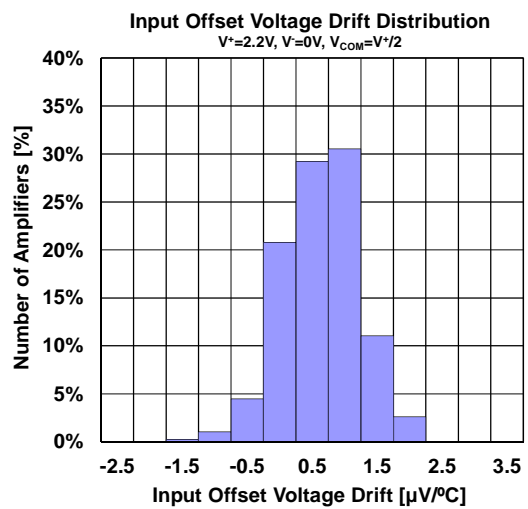
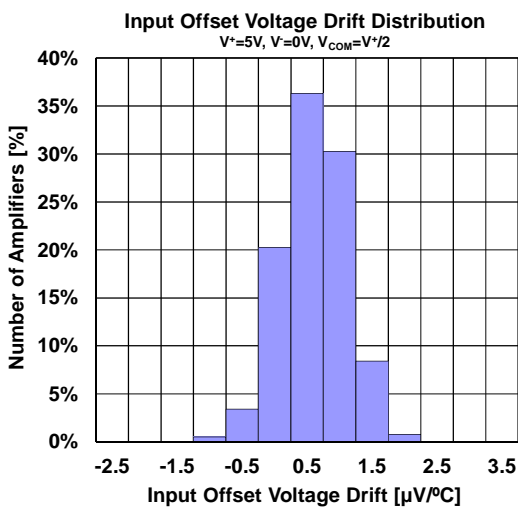
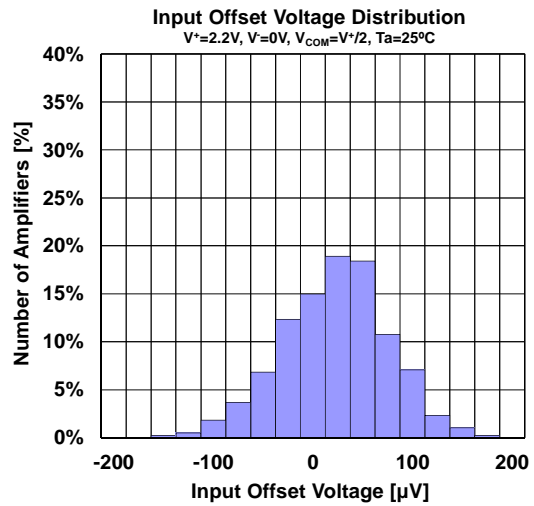
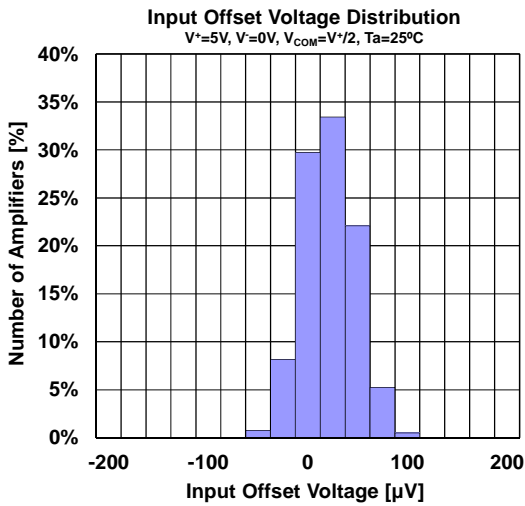
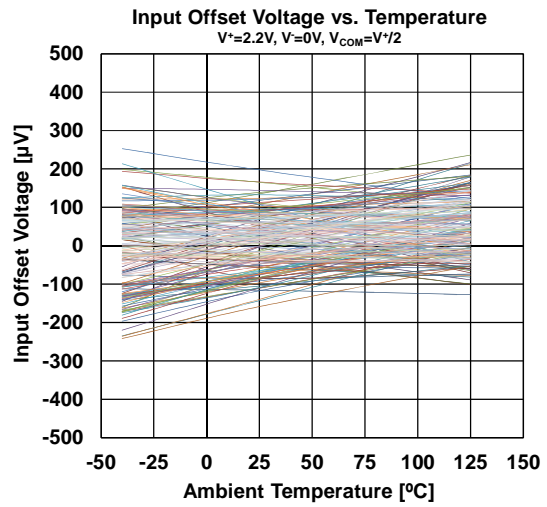
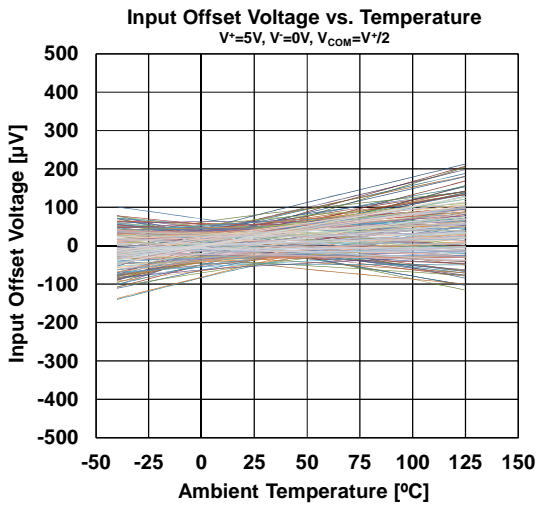

## ■ TYPICAL CHARACTERISTICS

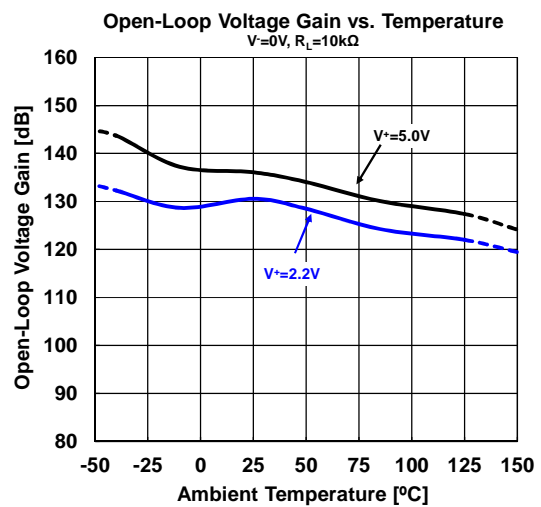
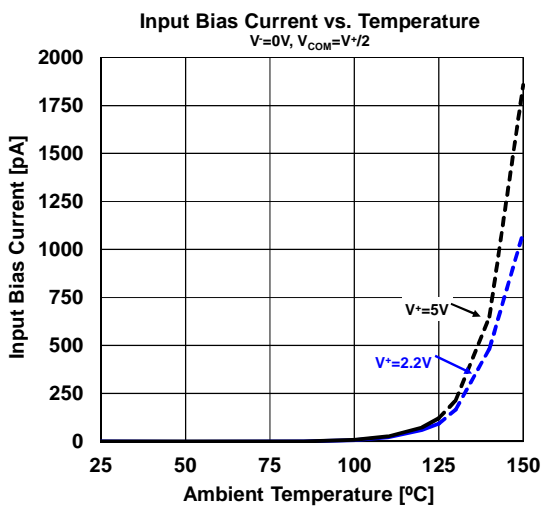
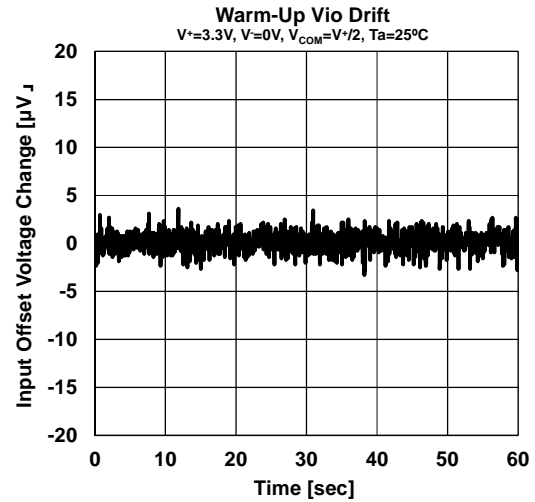
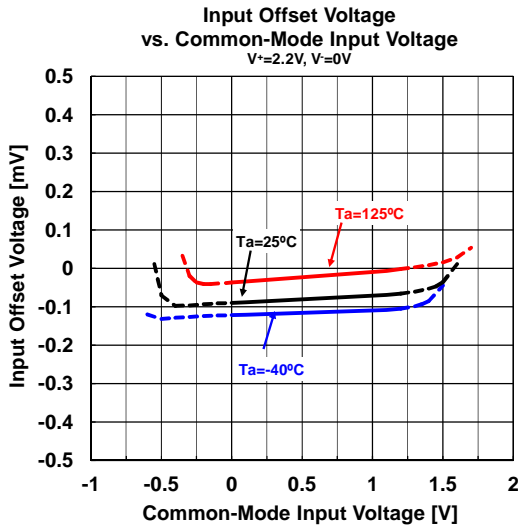
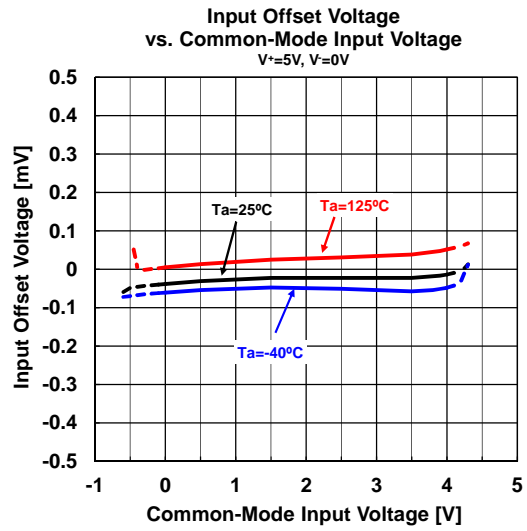
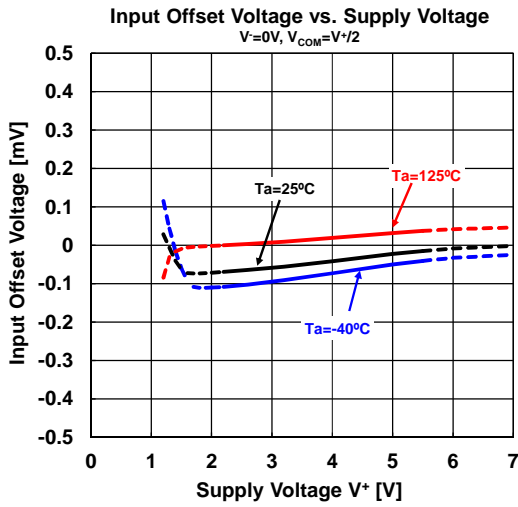

## ■ TYPICAL CHARACTERISTICS

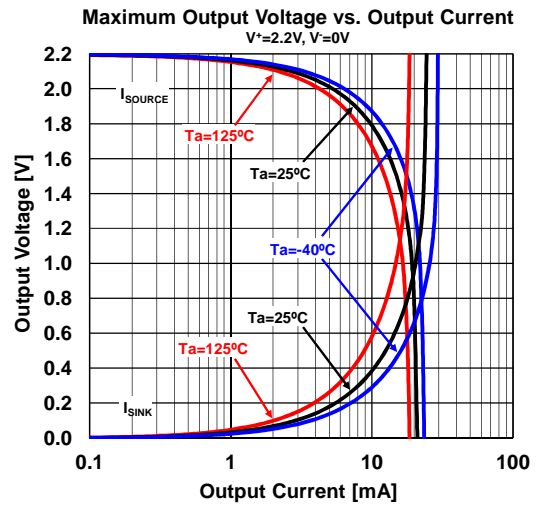
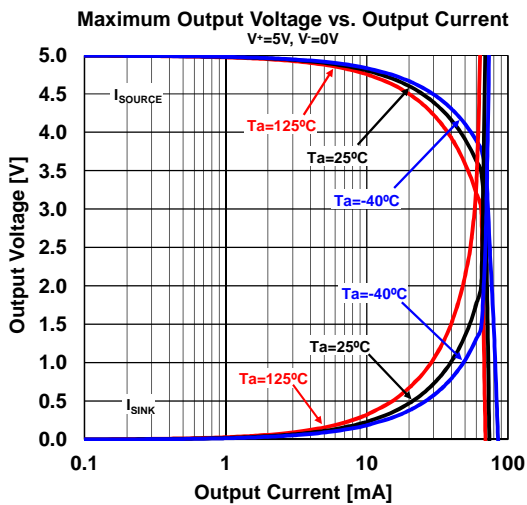
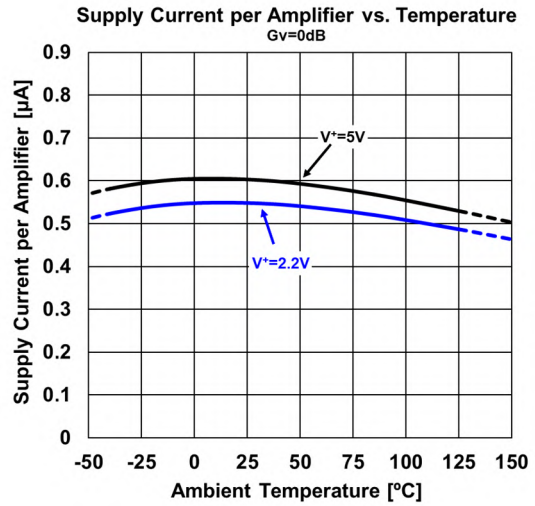
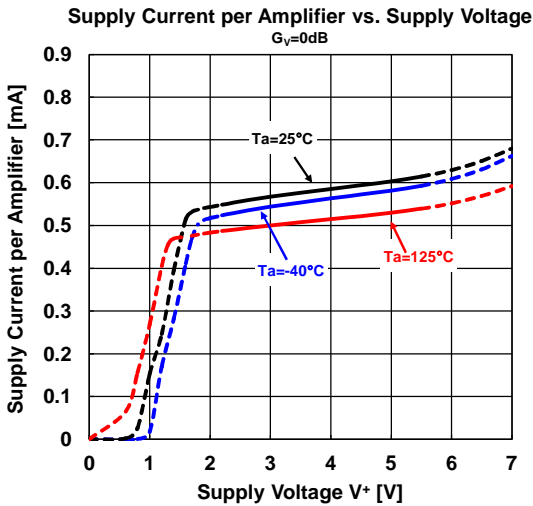
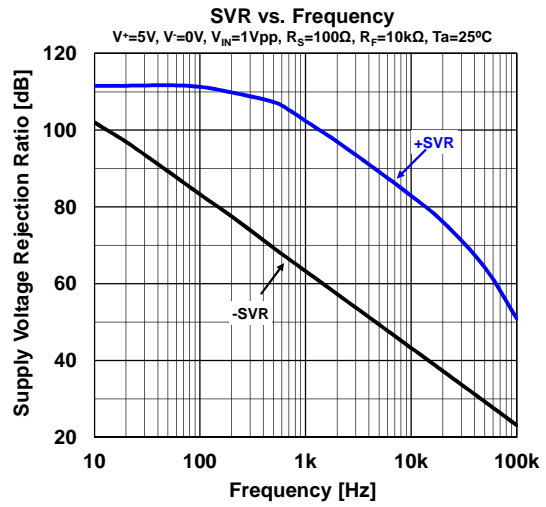
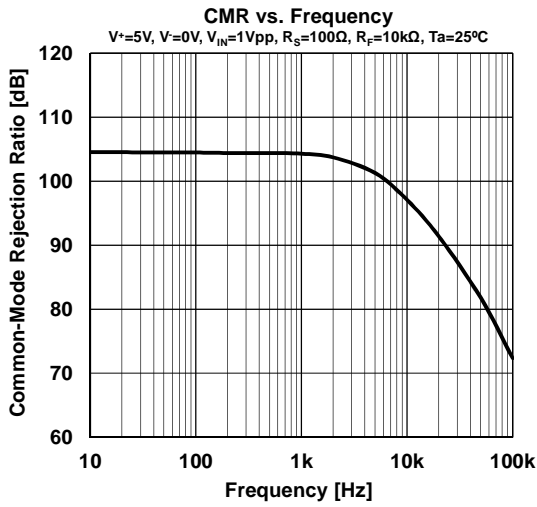



## ■ TYPICAL CHARACTERISTICS

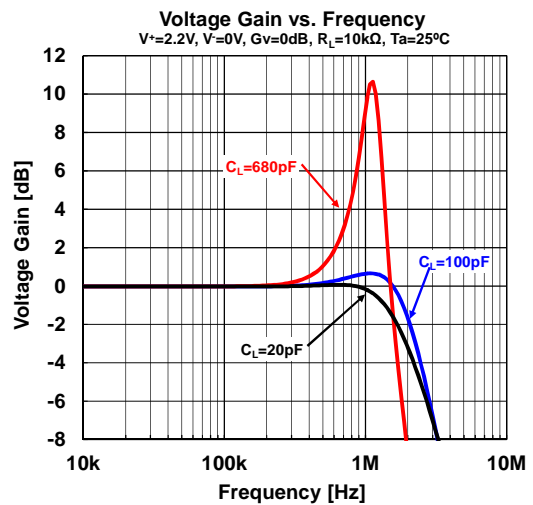
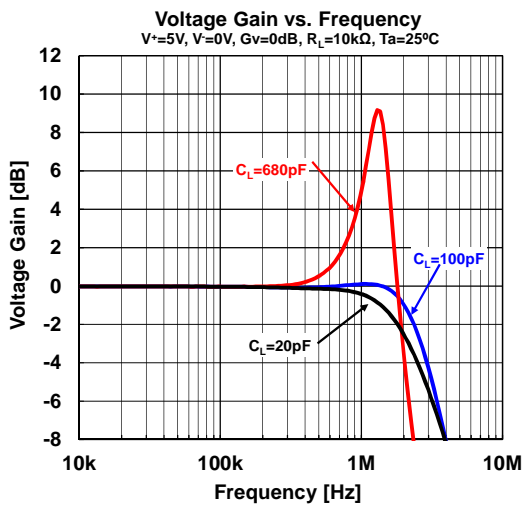
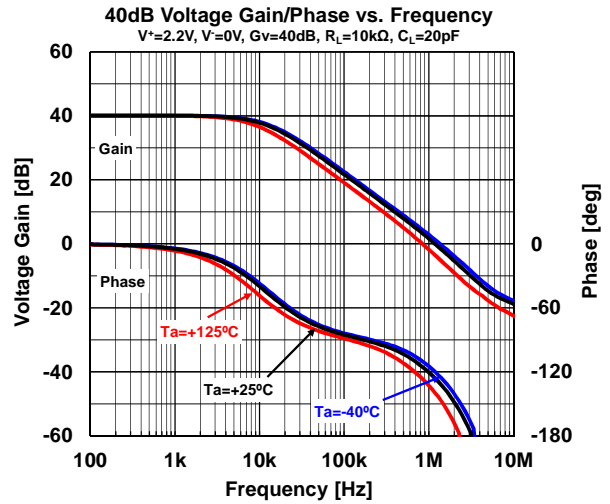
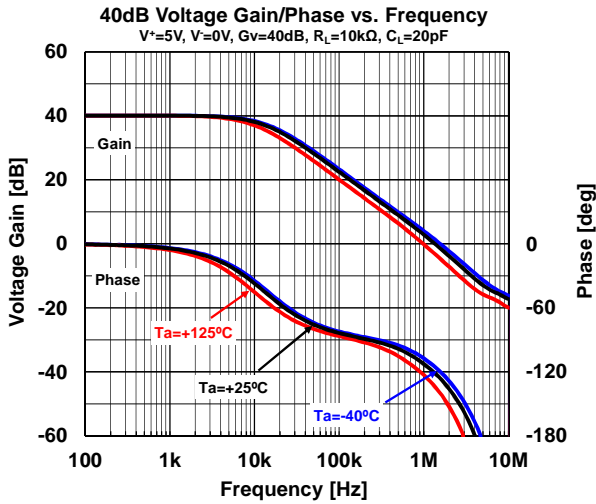
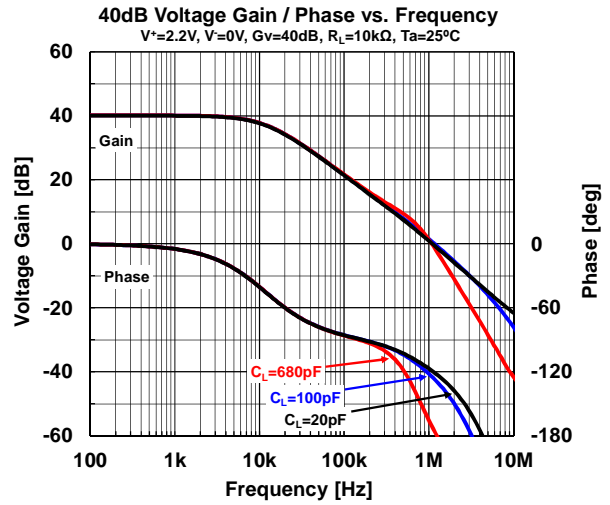
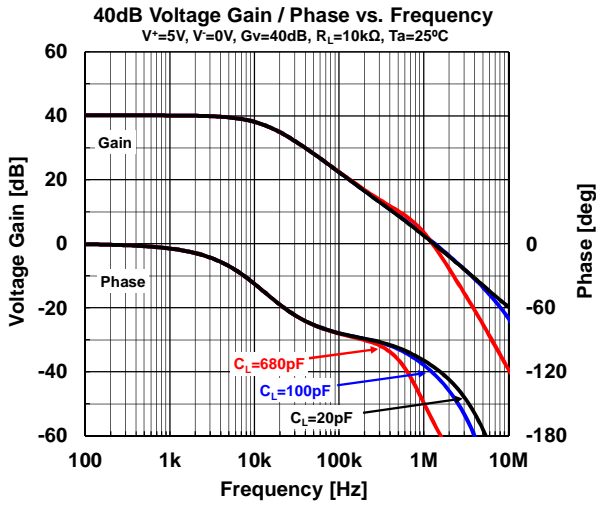

## ■ TYPICAL CHARACTERISTICS

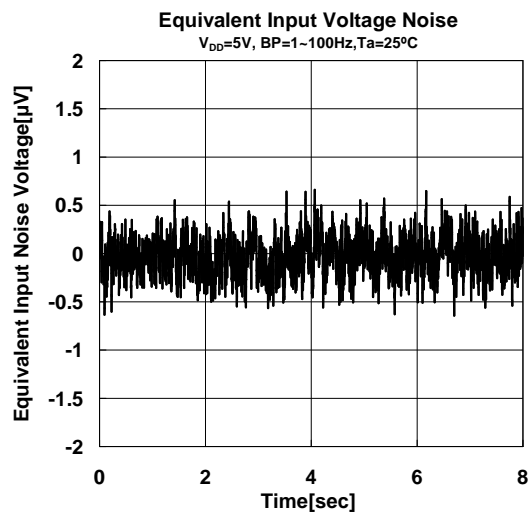
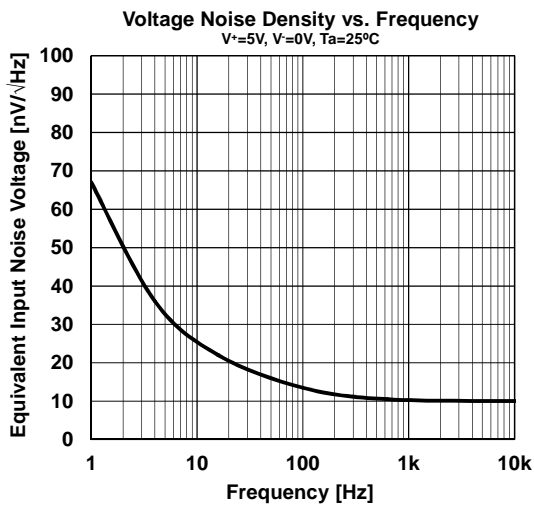
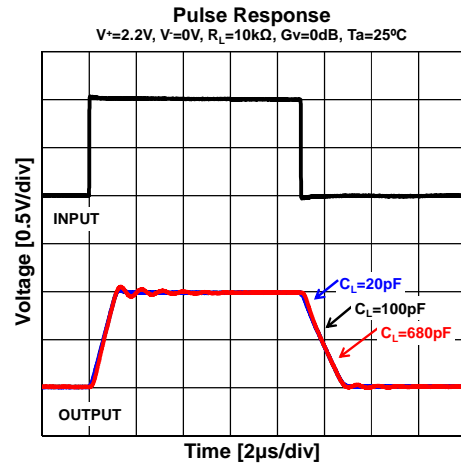
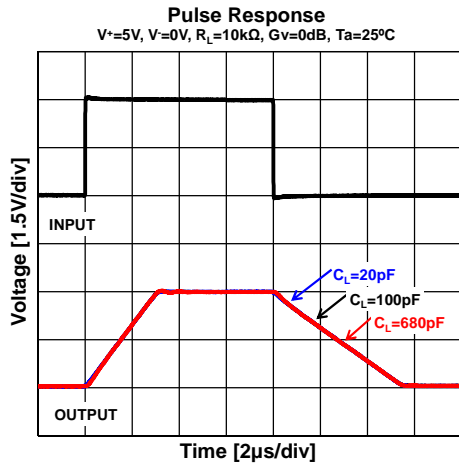
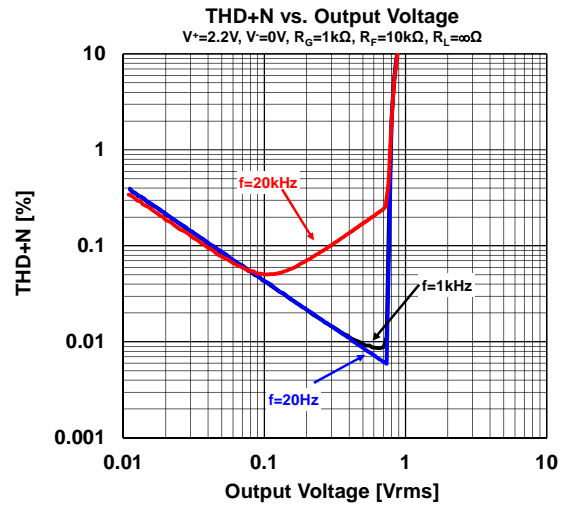
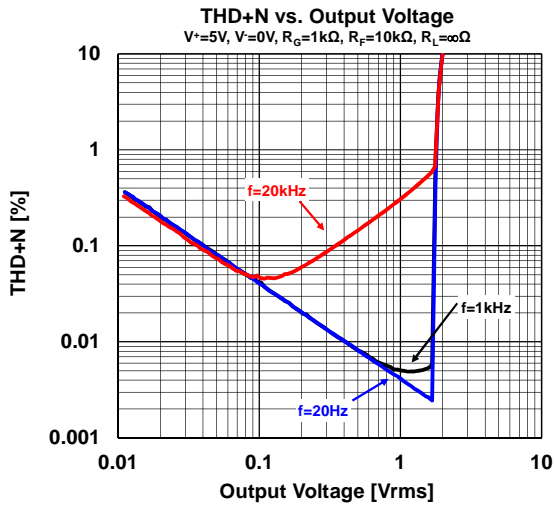

## ■ TYPICAL CHARACTERISTICS

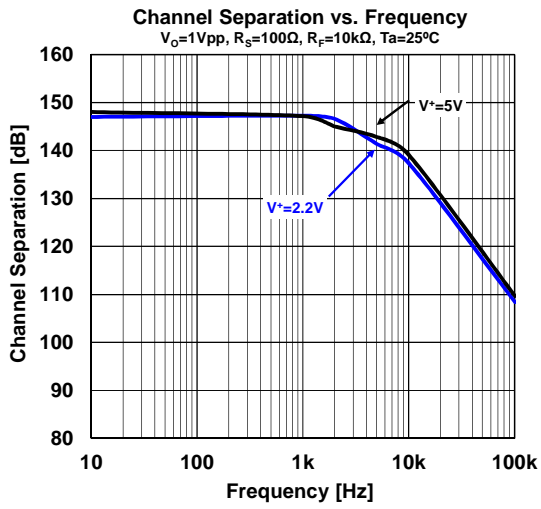

## ■ TEST CIRCUITS

### ● I<sub>SUPPLY</sub>

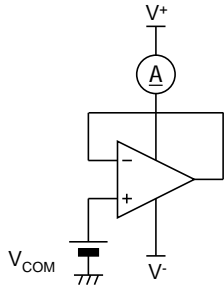

### ● V<sub>IO</sub>, CMR, SVR

$R_G=50\Omega, R_F=50k\Omega$

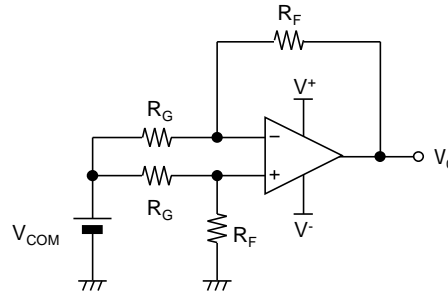

$$V_{IO} = \frac{R_G}{(R_G + R_F)} \times (V_O - V_{COM})$$

$$CMR = 20 \log \frac{\Delta V_{COM} \left(1 + \frac{R_F}{R_G}\right)}{\Delta V_O}$$

$$SVR = 20 \log \frac{\Delta V_S \left(1 + \frac{R_F}{R_G}\right)}{\Delta V_O}$$

$V_S = V^+ - V^-$

### ● V<sub>OH</sub>, V<sub>OL</sub>

$V_{OH}$ :  $V_{in+} = V^+/2 + 1V, V_{in-} = V^+/2, V_{COM} = V^+/2$

$V_{OL}$ :  $V_{in+} = V^+/2, V_{in-} = V^+/2 + 1V, V_{COM} = V^+/2$

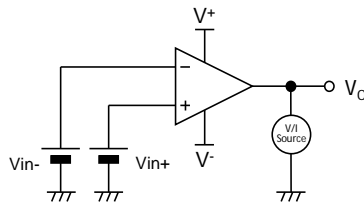
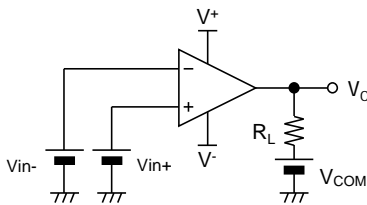

### ● GBW

$R_G=1k\Omega, R_F=100k\Omega$

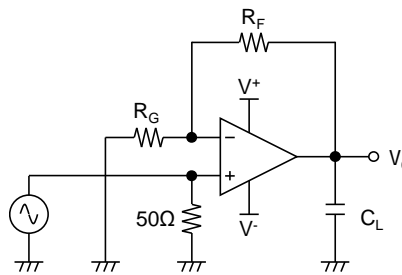

### ● SR

$R_L=100k\Omega$

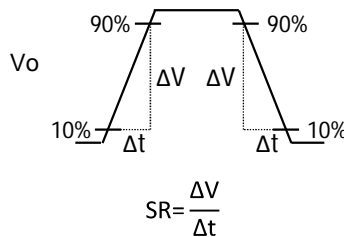
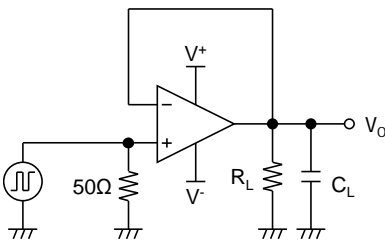

## ■ APPLICATION NOTE

### Single and Dual Supply Voltage Operation

The NJU7076/NJU7077/NJU7078 work with both single supply and dual supply when the voltage supplied is between  $V^+$  and  $V^-$ . These amplifiers operate from single 2.2 to 5.5V supply and dual  $\pm 1.1V$  to  $\pm 2.75V$  supply.

### Common-Mode Input Voltage Range

When the supply voltage does not meet the condition of electrical characteristics, the range of common-mode input voltage is as follows:

$$V_{ICM} \text{ (typ.)} = V^- \text{ to } V^+ - 1 \text{ (Ta} = 25^\circ\text{C)}$$

Difference of  $V_{ICM}$  when Temperature change, refer to typical characteristic graph.

During designing, consider variations in characteristics for use with allowance.

### Maximum Output Voltage Range

When the supply voltage does not meet the condition of electrical characteristics, the range of the typ. value of the maximum output voltage is as follows:

$$V_{OM} \text{ (typ.)} = V^+ - 20\text{mV to } V^- + 20\text{mV (R}_L = 10\text{k}\Omega \text{ to } V^+ / 2, \text{ Ta} = 25^\circ\text{C)}$$

During designing, consider variations in characteristics and temperature characteristics for use with allowance.

In addition, also note that the output voltage range becomes narrow as shown in typical characteristics graph when an output current increases.

### Capacitive Load

The NJU7076/NJU7077/NJU7078 can use at unity gain follower, but the unity gain follower is the most sensitive configuration to capacitive loading. The combination of capacitive load placed directly on the output of an amplifier along with the output impedance of the amplifier creates a phase lag which in turn reduces the phase margin of the amplifier. If phase margin is significantly reduced, the response will cause overshoot and ringing in the step response.

The NJU7076/NJU7077/NJU7078 are unity gain stable for capacitive loads of 470pF. To drive heavier capacitive loads, an isolation resistor,  $R_{ISO}$  as shown Figure1, should be used.  $R_{ISO}$  improves the feedback loop's phase margin by making the output load resistive at higher frequencies. The larger the value of  $R_{ISO}$ , the more stable the output voltage will be. However, larger values of  $R_{ISO}$  result in reduced output swing, reduced output current drive and reduced frequency bandwidth.

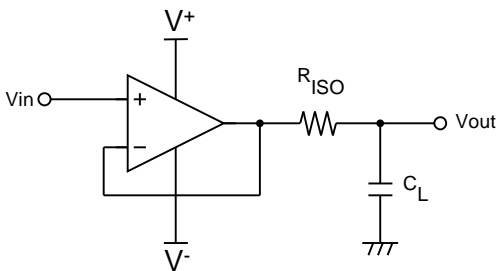

Figure1. Isolating capacitive load

### EMIRR (EMI Rejection Ratio) Definition

EMIRR is a parameter indicating the EMI robustness of an Op-Amp. The definition of EMIRR is given by the following equation1.

$$EMIRR = 20 \cdot \log \left( \frac{V_{RF\_PEAK}}{|\Delta V_{IO}|} \right) \quad \text{--}$$

-- eq. 1

$V_{RF\_PEAK}$ : RF Signal Amplitude [VP]

$\Delta V_{IO}$ : Input offset voltage shift quantity [V]

The tolerance of the RF signal can be grasped by measuring an RF signal and offset voltage shift quantity. Offset voltage shift is small so that a value of EMIRR is big. And it understands that the tolerance for the RF signal is high. In addition, about the input offset voltage shift with the RF signal, there is the thinking that influence applied to the input terminal is dominant. Therefore, generally the EMIRR becomes value that applied an RF signal to +INPUT terminal.

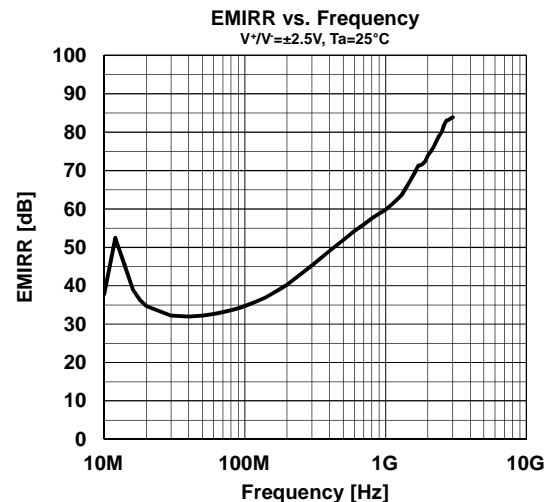

\*For details, refer to "Application Note for EMI Immunity" in our HP: <http://www.njr.com/>

## SOT-23-5

Unit: mm

### ■ PACKAGE DIMENSIONS

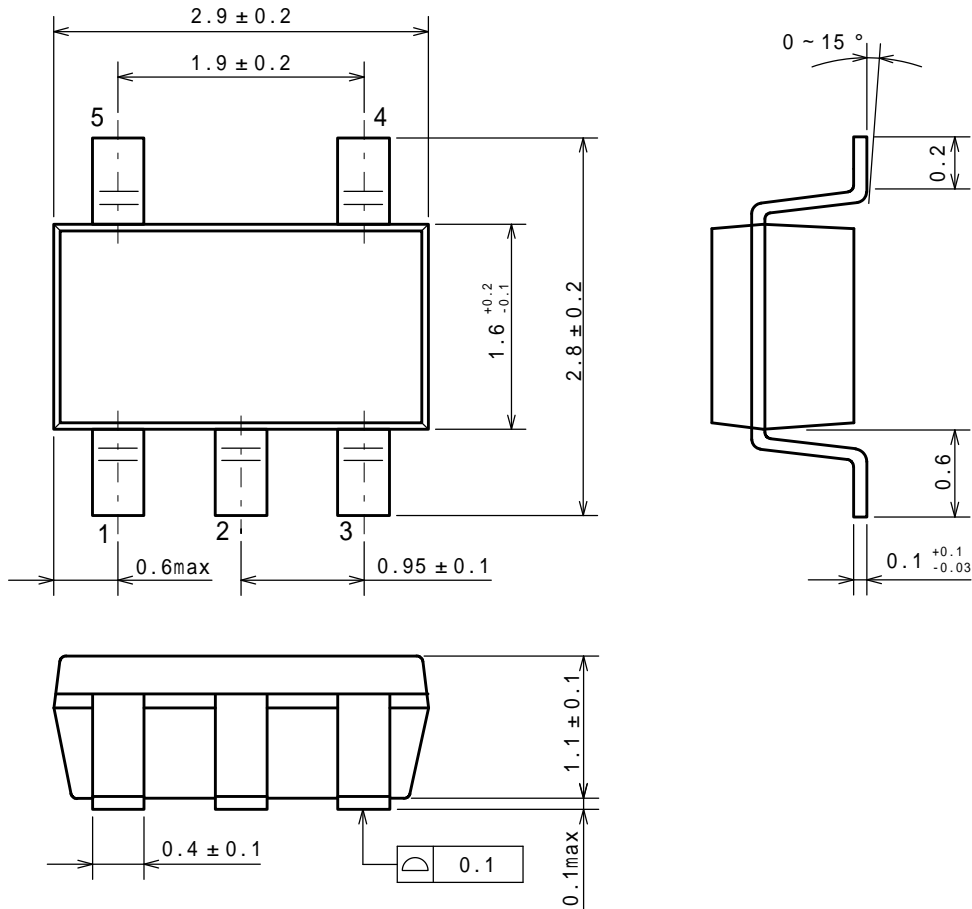

### ■ EXAMPLE OF SOLDER PADS DIMENSIONS

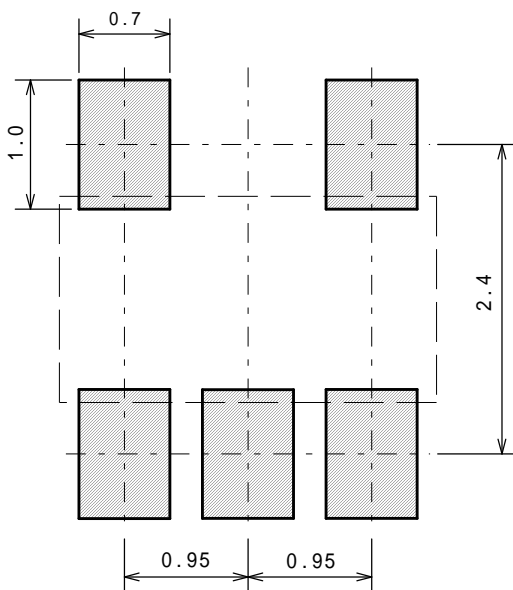

## MSOP8 (VSP8) MEET JEDEC MO-187-DA

Unit: mm

### ■ PACKAGE DIMENSIONS

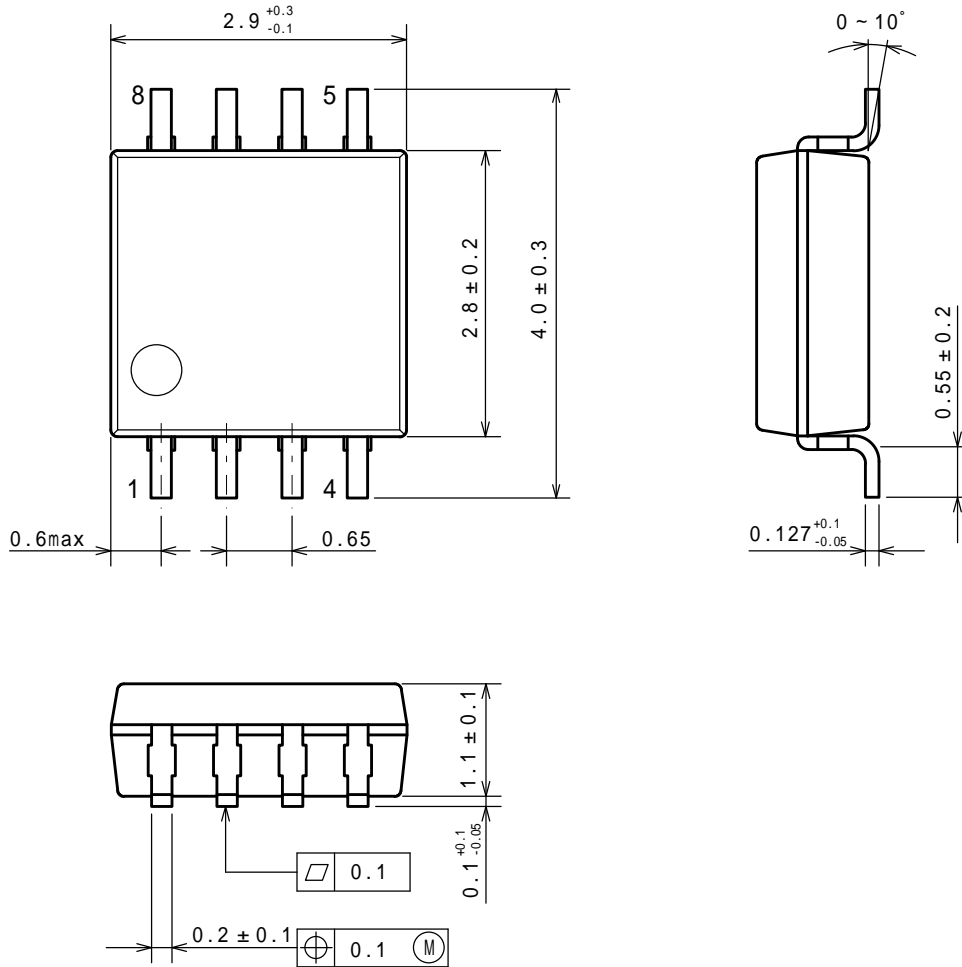

### ■ EXAMPLE OF SOLDER PADS DIMENSIONS

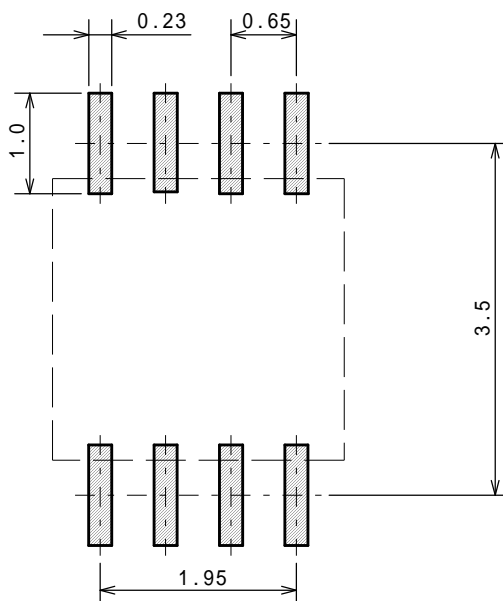

## SSOP14

Unit: mm

### ■ PACKAGE DIMENSIONS

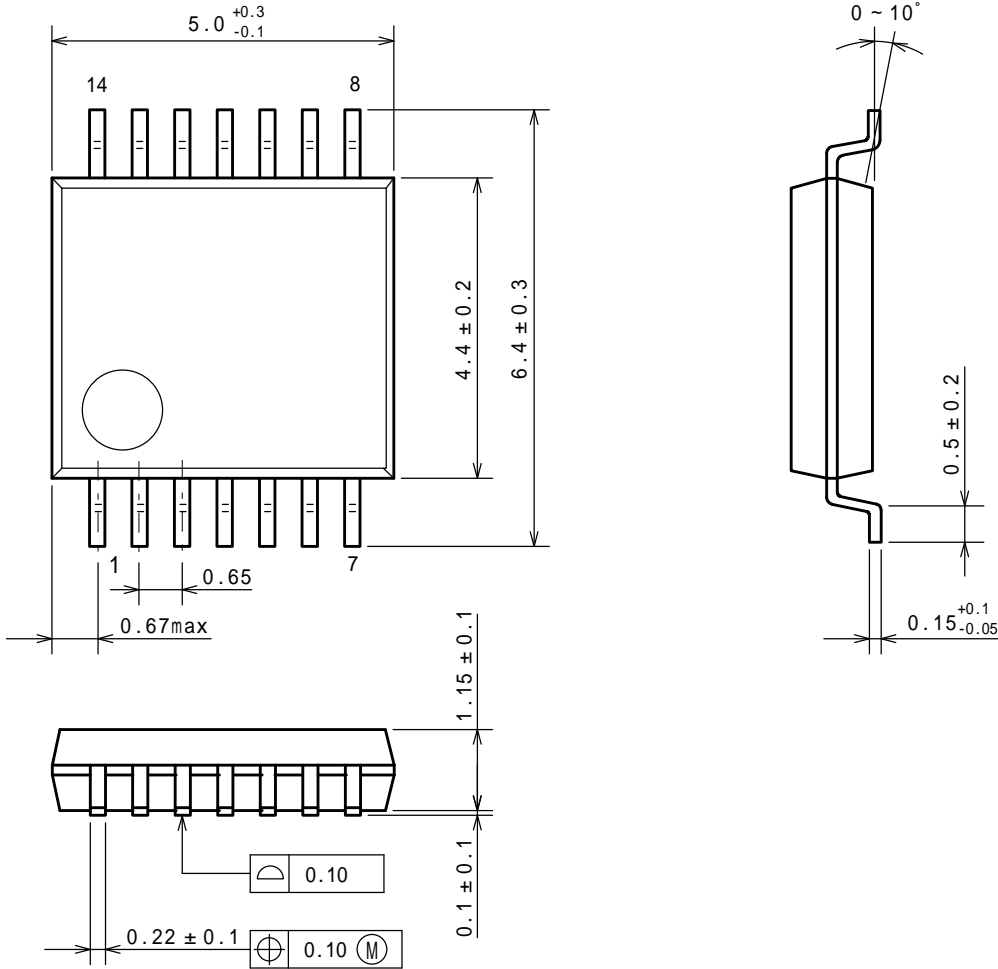

### ■ EXAMPLE OF SOLDER PADS DIMENSIONS

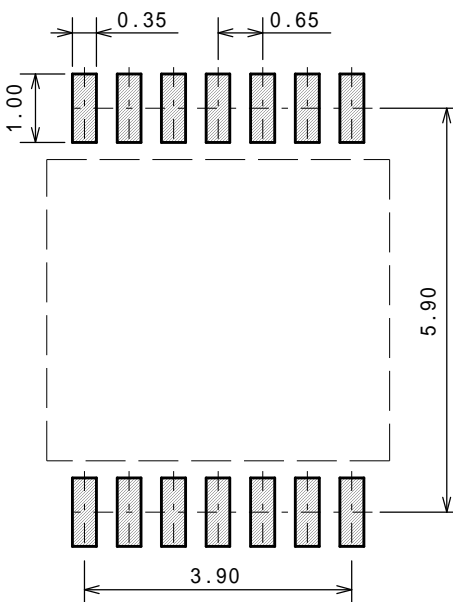



## SOT-23-5

### PACKING SPEC

Unit: mm

#### TAPING DIMENSIONS

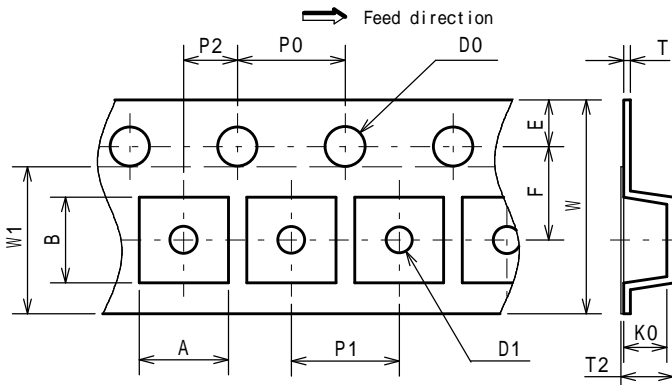

SYMBOL	DIMENSION	REMARKS
A	3.3 ± 0.1	BOTTOM DIMENSION
B	3.2 ± 0.1	BOTTOM DIMENSION
D0	1.55	
D1	1.05	
E	1.75 ± 0.1	
F	3.5 ± 0.05	
P0	4.0 ± 0.1	
P1	4.0 ± 0.1	
P2	2.0 ± 0.05	
T	0.25 ± 0.05	
T2	1.82	
K0	1.5 ± 0.1	
W	8.0 ± 0.3	
W1	5.5	THICKNESS 0.1MAX

#### REEL DIMENSIONS

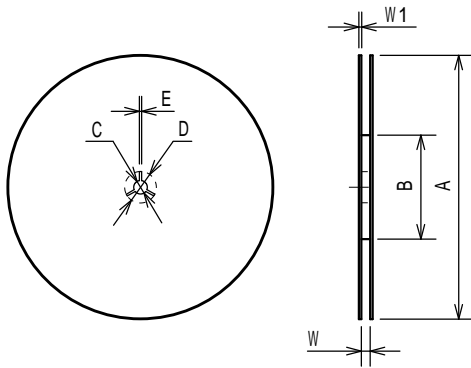

SYMBOL	DIMENSION
A	180 ± 1
B	60 ± 1
C	13 ± 0.2
D	21 ± 0.8
E	2 ± 0.5
W	9 ± 0.5
W1	1.2 ± 0.2

#### TAPING STATE

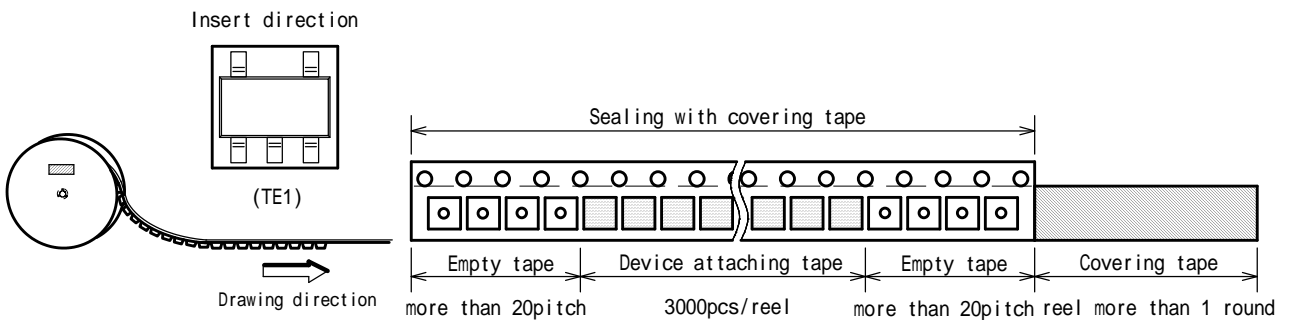

#### PACKING STATE

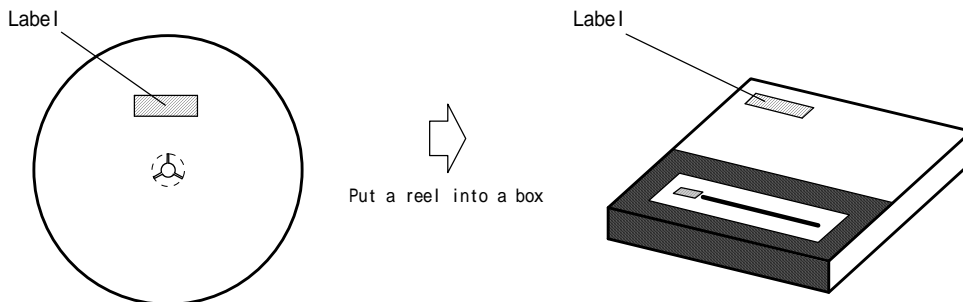

## MSOP8 (VSP8) MEET JEDEC MO-187-DA

### PACKING SPEC

Unit: mm

#### TAPING DIMENSIONS

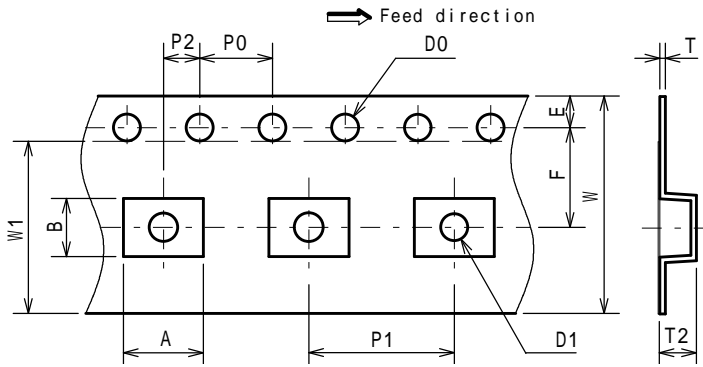

SYMBOL	DIMENSION	REMARKS
A	4.4	BOTTOM DIMENSION
B	3.2	BOTTOM DIMENSION
D0	1.5 <sup>+0.1</sup> <sub>0</sub>	
D1	1.5 <sup>+0.1</sup> <sub>0</sub>	
E	1.75 ± 0.1	
F	5.5 ± 0.05	
P0	4.0 ± 0.1	
P1	8.0 ± 0.1	
P2	2.0 ± 0.05	
T	0.30 ± 0.05	
T2	2.0 (MAX.)	
W	12.0 ± 0.3	
W1	9.5	THICKNESS 0.1max

#### REEL DIMENSIONS

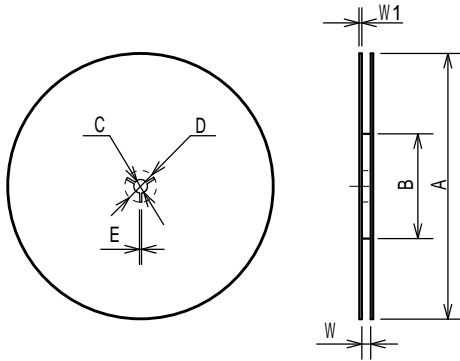

SYMBOL	DIMENSION
A	254 ± 2
B	100 ± 1
C	13 ± 0.2
D	21 ± 0.8
E	2 ± 0.5
W	13.5 ± 0.5
W1	2.0 ± 0.2

#### TAPING STATE

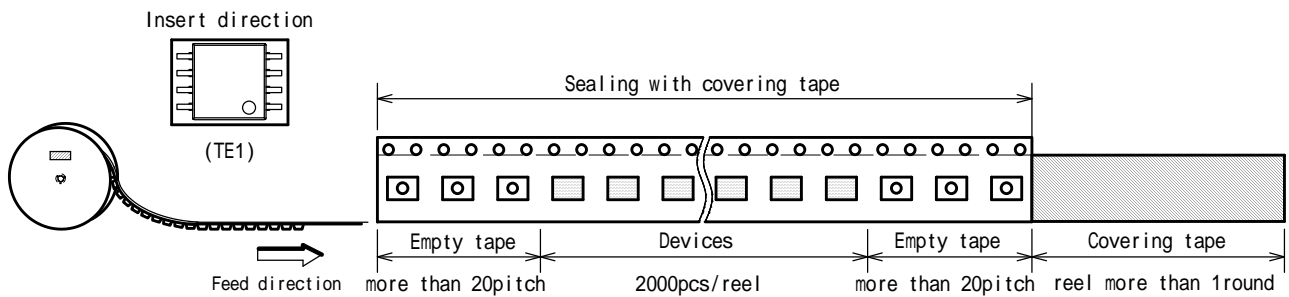

#### PACKING STATE

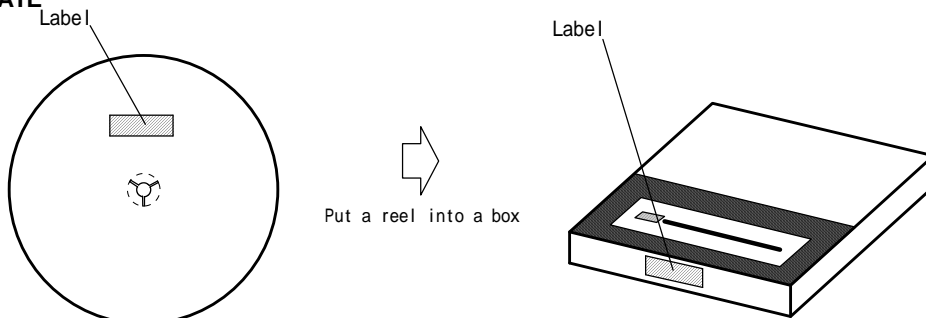

## SSOP14

### PACKING SPEC

Unit: mm

#### TAPING DIMENSIONS

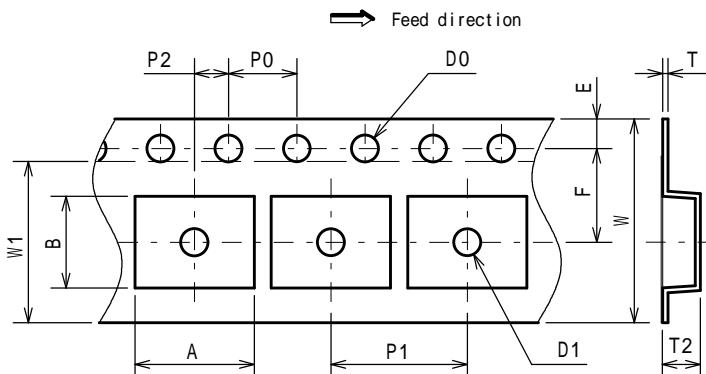

SYMBOL	DIMENSION	REMARKS
A	6.95	BOTTOM DIMENSION
B	5.4	BOTTOM DIMENSION
D0	1.55 ± 0.05	
D1	1.55 ± 0.1	
E	1.75 ± 0.1	
F	5.5 ± 0.05	
P0	4.0 ± 0.1	
P1	8.0 ± 0.1	
P2	2.0 ± 0.05	
T	0.3 ± 0.05	
T2	2.2	
W	12.0 ± 0.3	
W1	9.5	THICKNESS 0.1max

#### REEL DIMENSIONS

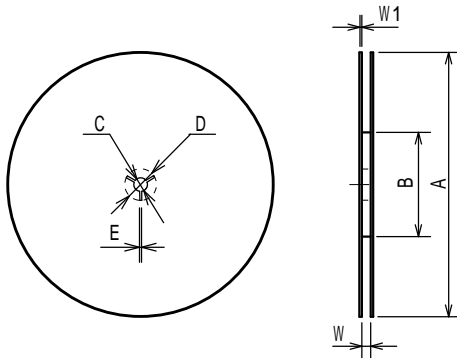

SYMBOL	DIMENSION
A	254 ± 2
B	100 ± 1
C	13 ± 0.2
D	21 ± 0.8
E	2 ± 0.5
W	13.5 ± 0.5
W1	2 ± 0.2

#### TAPING STATE

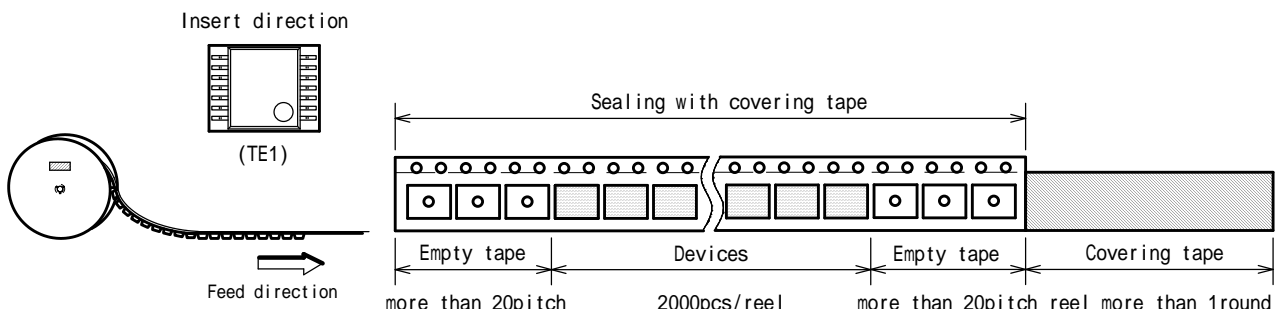

#### PACKING STATE

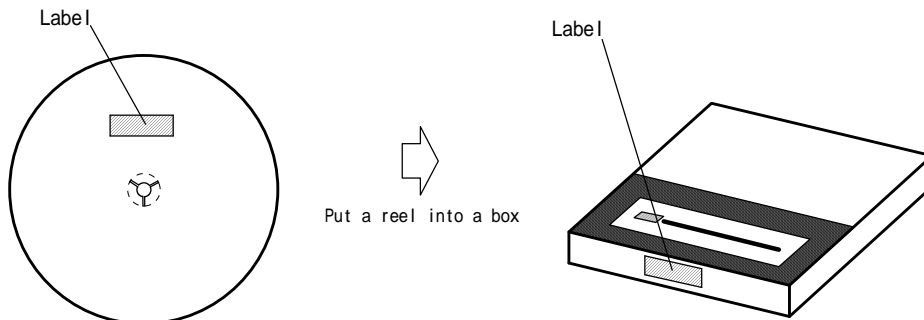

## ■ RECOMMENDED MOUNTING METHOD

### INFRARED REFLOW SOLDERING PROFILE

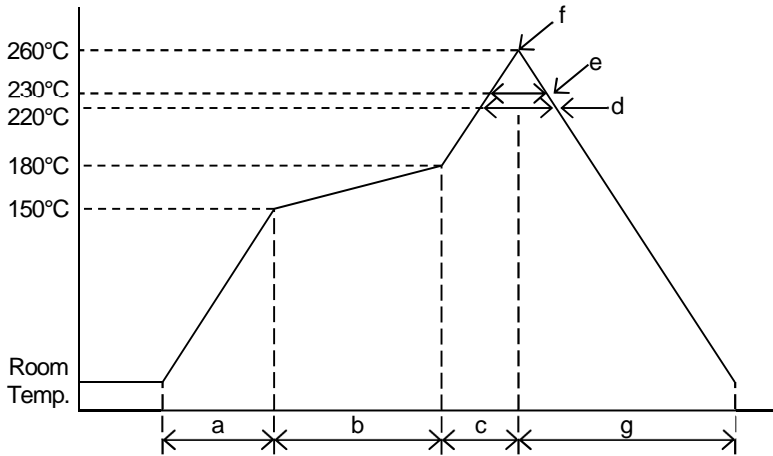

a	Temperature ramping rate	1 to 4°C/s
b	Pre-heating temperature	150 to 180°C
	Pre-heating time	60 to 120s
c	Temperature ramp rate	1 to 4°C/s
d	220°C or higher time	shorter than 60s
e	230°C or higher time	shorter than 40s
f	Peak temperature	lower than 260°C
g	Temperature ramping rate	1 to 6°C/s

The temperature indicates at the surface of mold package.

## ■ REVISION HISTORY

DATA	REVISION	CHANGES
May 23, 2019	Ver.6.0	Changed datasheet format.
July 11, 2019	Ver.6.1	Err note correction.
Dec 14, 2020	Ver.6.2	Supply Current per Amplifier vs. Supply Voltage condition correction.

## [ CAUTION ]

1. NJR strives to produce reliable and high quality semiconductors. NJR's semiconductors are intended for specific applications and require proper maintenance and handling. To enhance the performance and service of NJR's semiconductors, the devices, machinery or equipment into which they are integrated should undergo preventative maintenance and inspection at regularly scheduled intervals. Failure to properly maintain equipment and machinery incorporating these products can result in catastrophic system failures
2. The specifications on this datasheet are only given for information without any guarantee as regards either mistakes or omissions. The application circuits in this datasheet are described only to show representative usages of the product and not intended for the guarantee or permission of any right including the industrial property rights.  
All other trademarks mentioned herein are the property of their respective companies.
3. To ensure the highest levels of reliability, NJR products must always be properly handled.  
The introduction of external contaminants (e.g. dust, oil or cosmetics) can result in failures of semiconductor products.
4. NJR offers a variety of semiconductor products intended for particular applications. It is important that you select the proper component for your intended application. You may contact NJR's Sale's Office if you are uncertain about the products listed in this datasheet.
5. Special care is required in designing devices, machinery or equipment which demand high levels of reliability. This is particularly important when designing critical components or systems whose failure can foreseeably result in situations that could adversely affect health or safety. In designing such critical devices, equipment or machinery, careful consideration should be given to amongst other things, their safety design, fail-safe design, back-up and redundancy systems, and diffusion design.
6. The products listed in this datasheet may not be appropriate for use in certain equipment where reliability is critical or where the products may be subjected to extreme conditions. You should consult our sales office before using the products in any of the following types of equipment.
  - Aerospace Equipment
  - Equipment Used in the Deep Sea
  - Power Generator Control Equipment (Nuclear, steam, hydraulic, etc.)
  - Life Maintenance Medical Equipment
  - Fire Alarms / Intruder Detectors
  - Vehicle Control Equipment (Airplane, railroad, ship, etc.)
  - Various Safety Devices
7. NJR's products have been designed and tested to function within controlled environmental conditions. Do not use products under conditions that deviate from methods or applications specified in this datasheet. Failure to employ the products in the proper applications can lead to deterioration, destruction or failure of the products. NJR shall not be responsible for any bodily injury, fires or accident, property damage or any consequential damages resulting from misuse or misapplication of the products. The products are sold without warranty of any kind, either express or implied, including but not limited to any implied warranty of merchantability or fitness for a particular purpose.
8. Warning for handling Gallium and Arsenic (GaAs) Products (Applying to GaAs MMIC, Photo Reflector). These products use Gallium (Ga) and Arsenic (As) which are specified as poisonous chemicals by law. For the prevention of a hazard, do not burn, destroy, or process chemically to make them as gas or power. When the product is disposed of, please follow the related regulation and do not mix this with general industrial waste or household waste.
9. The product specifications and descriptions listed in this datasheet are subject to change at any time, without notice.

