

Precision, Low Noise, Rail-to-Rail Output, Single CMOS Operational Amplifier

■ GENERAL DESCRIPTION

The NJU7076B is a high precision Rail-to-Rail output Single CMOS operational amplifier featuring a low noise of $10\text{nV}/\sqrt{\text{Hz}}$ (typ.), low input offset voltage of $300\mu\text{V}$ (max.), low temperature drift of $0.5\mu\text{V}/^\circ\text{C}$ (typ.) and low bias current of 1pA (typ.).

The output swing can reach 20mV from the rails, while driving a $10\text{k}\Omega$ load (at 5V operation). The NJU7076B also has a high RF immunity which can reduce malfunctions caused by RF noises from mobile phones and others. The combination of these specifications makes the NJU7076B well-suited for sensor applications such as a temperature sensor, weight sensor and others, high precision current sensing amplifiers and current voltage converters.

■ PACKAGE OUTLINE



NJU7076BF3
(SC-88A)

■ FEATURES

- High Precision
 - Low Offset Voltage 300 μV max.
 - Low Offset Voltage Drift 0.5 $\mu\text{V}/^\circ\text{C}$ typ.
- Low Noise 10 $\text{nV}/\sqrt{\text{Hz}}$ typ.
- Low Input Bias Current 1 pA typ.
- Rail-to-Rail Output
 - $R_L=10\text{k}\Omega$ 20 mV from Rail typ.
 - $R_L=600\Omega$ 80 mV from Rail typ.
- Ground sense
- RF Immunity
- Operating Voltage 2.2V to 5.5V
- Unity-Gain Stable
- Package SC-88A

■ APPLICATIONS

- Thermocouple / Thermopile Amplifiers
- Strain Gauge / Pressure sensor Amplifiers
- Load Cell and Bridge Transducer Amplifiers
- High Resolution Data Acquisition
- Precision Current Sensing
- Battery monitoring
- Photo-Diode pre amplifier

■ PIN CONFIGURATION

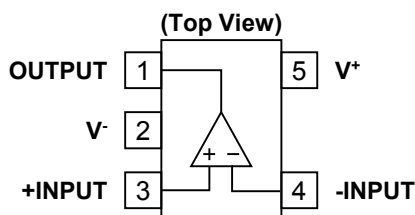

■ ABSOLUTE MAXIMUM RATINGS (Ta=25°C, unless otherwise noted.)

PARAMETER	SYMBOL	RATING	UNIT
Supply Voltage	$V^+ - V^-$	7 ⁽¹⁾	V
Differential Input Voltage ⁽²⁾	V_{ID}	± 7 ⁽³⁾	V
Input Voltage	V_{IN}	$V^- - 0.3$ to $V^+ + 0.3$	V
Power Dissipation ⁽⁴⁾	P_D	(2-layer / 4-layer)	mW
SC-88A		360 / 490	mW
Operating Temperature Range	T_{opr}	-40 to +125	°C
Storage Temperature Range	T_{stg}	-55 to +150	°C

(1) Supply Voltage is the voltage difference between V^+ and V^- .

(1) Differential voltage is the voltage difference between +INPUT and -INPUT.

(3) For supply voltage less than 7V, the absolute maximum rating is equal to the supply voltage.

(4) Power dissipation is the power that can be consumed by the IC at Ta=25°C, and is the typical measured value based on JEDEC condition. When using the IC over Ta=25°C subtract the value $[mW/°C]=PD/(T_{stg}(MAX)-25)$ per temperature.

2-layer: EIA/JEDEC STANDARD Test board (76.2x114.3x1.6mm, 2layers, FR-4) mounting

4-layer: EIA/JEDEC STANDARD Test board (76.2x114.3x1.6mm, 4layers, FR-4) mounting

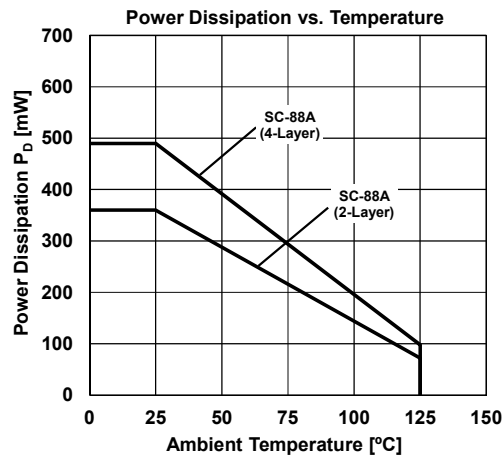

■ RECOMMENDED OPERATING CONDITIONS (Ta=25°C)

PARAMETER	Value	UNIT
Supply Voltage	+2.2 to +5.5 (± 1.1 to ± 2.75)	V

■ ELECTRICAL CHARACTERISTICS($V^+=5V$, $V^-=0V$, $V_{COM}=V^+/2$, $T_a=25^\circ C$, unless otherwise noted.)

PARAMETER	SYMBOL	TEST CONDITION	MIN.	TYP.	MAX.	UNIT
DC CHARACTERISTICS						
Supply Current	I_{SUPPLY}	No Signal, $R_L=OPEN$	-	0.6	0.9	mA
		No Signal, $R_L=OPEN$, $T_a = -40^\circ C$ to $125^\circ C$	-	-	0.9	mA
Input Offset Voltage	V_{IO}	$T_a=-40^\circ C$ to $125^\circ C$	-	20	300	μV
			-	-	400	μV
Input Offset Voltage Drift	$\Delta V_{IO}/\Delta T$	$T_a=-40^\circ C$ to $125^\circ C$ ⁽⁵⁾	-	0.5	5	$\mu V/^\circ C$
Input Bias Current	I_B		-	1	-	pA
Input Offset Current	I_{IO}		-	1	-	pA
Open-Loop Voltage Gain	A_v	$V_o=0.5V$ to $4.5V$, $R_L=10k\Omega$ to $2.5V$	100	130	-	dB
		$V_o=0.5V$ to $4.5V$, $R_L=10k\Omega$ to $2.5V$, $T_a= -40^\circ C$ to $125^\circ C$	100	-	-	dB
Common-Mode Rejection Ratio	CMR	$V_{ICM}=0V$ to $4V$	70	90	-	dB
		$V_{ICM}=0V$ to $4V$, $T_a= -40^\circ C$ to $125^\circ C$	70	-	-	dB
Supply Voltage Rejection Ratio	SVR	$V^+=2.2V$ to $5.5V$	70	90	-	dB
		$V^+=2.2V$ to $5.5V$, $T_a= -40^\circ C$ to $125^\circ C$	70	-	-	dB
High-level Output Voltage	V_{OH}	$R_L=10k\Omega$ to $2.5V$	4.95	4.98	-	V
		$R_L=10k\Omega$ to $2.5V$, $T_a= -40^\circ C$ to $125^\circ C$	4.95	-	-	V
		$R_L=600\Omega$ to $2.5V$	4.85	4.92	-	V
		$R_L=600\Omega$ to $2.5V$, $T_a= -40^\circ C$ to $125^\circ C$	4.85	-	-	V
		$I_{SOURCE}=2mA$	4.9	4.96	-	V
		$I_{SOURCE}=2mA$, $T_a= -40^\circ C$ to $125^\circ C$	4.85	-	-	V
Low-level Output Voltage	V_{OL}	$R_L=10k\Omega$ to $2.5V$	-	0.02	0.05	V
		$R_L=10k\Omega$ to $2.5V$, $T_a= -40^\circ C$ to $125^\circ C$	-	-	0.05	V
		$R_L=600\Omega$ to $2.5V$	-	0.08	0.15	V
		$R_L=600\Omega$ to $2.5V$, $T_a= -40^\circ C$ to $125^\circ C$	-	-	0.2	V
		$I_{SINK}=2mA$	-	0.04	0.1	V
		$I_{SINK}=2mA$, $T_a= -40^\circ C$ to $125^\circ C$	-	-	0.15	V
Common-Mode Input Voltage Range	V_{ICM}	CMR \geq 70dB	0	-	4	V
		CMR \geq 70dB, $T_a= -40^\circ C$ to $125^\circ C$	0	-	4	V
AC CHARACTERISTICS						
Gain Bandwidth Product	GBW	$G_V=40dB$, $R_F=100k\Omega$, $R_L=10k\Omega$ to $2.5V$, $C_L=20pF$, $f=100kHz$	-	1.3	-	MHz
Phase Margin	Φ_m	$G_V=40dB$, $R_F=100k\Omega$, $R_L=10k\Omega$ to $2.5V$, $C_L=20pF$	-	60	-	deg
Gain Margin	G_m	$G_V=40dB$, $R_F=100k\Omega$, $R_L=10k\Omega$ to $2.5V$, $C_L=20pF$	-	12	-	dB
Equivalent Input Noise Voltage	e_n	$f=1kHz$	-	10	-	nV/\sqrt{Hz}
Slew Rate	SR	$G_V=0dB$, $R_L=10k\Omega$ to $2.5V$, $C_L=20pF$, $V_{IN}=3V_{PP}$	-	0.5	-	V/ μs
Total Harmonic Distortion	THD	$G_V=20dB$, $R_L=10k\Omega$ to $2.5V$, $f=1kHz$, $V_O=3V_{PP}$	-	0.01	-	%

(5) Guaranteed by two points of Temperature $-40^\circ C$ and $+125^\circ C$

■ ELECTRICAL CHARACTERISTICS($V^+=2.2V$, $V^-=0V$, $V_{COM}=V^+/2$, $T_a=25^\circ C$, unless otherwise noted.)

PARAMETER	SYMBOL	TEST CONDITION	MIN.	TYP.	MAX.	UNIT
DC CHARACTERISTICS						
Supply Current	I_{SUPPLY}	No Signal, $R_L=OPEN$	-	0.55	0.82	mA
		No Signal, $R_L=OPEN$, $T_a = -40^\circ C$ to $125^\circ C$	-	-	0.82	mA
Input Offset Voltage	V_{IO}	$T_a = -40^\circ C$ to $125^\circ C$	-	60	300	μV
			-	-	400	μV
Input Offset Voltage Drift	$\Delta V_{IO}/\Delta T$	$T_a = -40^\circ C$ to $125^\circ C$ ⁽⁵⁾	-	0.6	5	$\mu V/^\circ C$
Input Bias Current	I_B		-	1	-	pA
Input Offset Current	I_{IO}		-	1	-	pA
Open-Loop Voltage Gain	A_v	$V_o=0.6V$ to $1.6V$, $R_L=10k\Omega$ to $1.1V$	100	130	-	dB
		$V_o=0.6V$ to $1.6V$, $R_L=10k\Omega$ to $1.1V$, $T_a = -40^\circ C$ to $125^\circ C$	100	-	-	dB
Common-Mode Rejection Ratio	CMR	$V_{ICM}=0V$ to $1.2V$	70	90	-	dB
		$V_{ICM}=0V$ to $1.2V$, $T_a = -40^\circ C$ to $125^\circ C$	70	-	-	dB
High-level Output Voltage	V_{OH}	$R_L=10k\Omega$ to $1.1V$	2.15	2.18	-	V
		$R_L=10k\Omega$ to $1.1V$, $T_a = -40^\circ C$ to $125^\circ C$	2.15	-	-	V
		$R_L=600\Omega$ to $1.1V$	2.1	2.14	-	V
		$R_L=600\Omega$ to $1.1V$, $T_a = -40^\circ C$ to $125^\circ C$	2.05	-	-	V
		$I_{SOURCE}=2mA$	2.05	2.13	-	V
	$I_{SOURCE}=2mA$, $T_a = -40^\circ C$ to $125^\circ C$	2	-	-	V	
Low-level Output Voltage	V_{OL}	$R_L=10k\Omega$ to $1.1V$	-	0.02	0.05	V
		$R_L=10k\Omega$ to $1.1V$, $T_a = -40^\circ C$ to $125^\circ C$	-	-	0.05	V
		$R_L=600\Omega$ to $1.1V$	-	0.06	0.1	V
		$R_L=600\Omega$ to $1.1V$, $T_a = -40^\circ C$ to $125^\circ C$	-	-	0.15	V
		$I_{SINK}=2mA$	-	0.07	0.15	V
	$I_{SINK}=2mA$, $T_a = -40^\circ C$ to $125^\circ C$	-	-	0.2	V	
Common-Mode Input Voltage Range	V_{ICM}	CMR $\geq 70dB$	0	-	1.2	V
		CMR $\geq 70dB$, $T_a = -40^\circ C$ to $125^\circ C$	0	-	1.2	V
AC CHARACTERISTICS						
Gain Bandwidth Product	GBW	$G_v=40dB$, $R_F=100k\Omega$, $R_L=10k\Omega$ to $1.1V$, $C_L=20pF$, $f=100kHz$	-	1.2	-	MHz
Phase Margin	Φ_m	$G_v=40dB$, $R_F=100k\Omega$, $R_L=10k\Omega$ to $1.1V$, $C_L=20pF$	-	60	-	deg
Gain Margin	G_m	$G_v=40dB$, $R_F=100k\Omega$, $R_L=10k\Omega$ to $1.1V$, $C_L=20pF$	-	12	-	dB
Equivalent Input Noise Voltage	e_n	$f=1kHz$	-	10	-	nV/\sqrt{Hz}
Slew Rate	SR	$G_v=0dB$, $R_L=10k\Omega$, $C_L=20pF$, $V_{IN}=1V_{PP}$	-	0.5	-	$V/\mu s$
Total Harmonic Distortion	THD	$G_v=20dB$, $R_L=10k\Omega$, $f=1kHz$, $V_o=1V_{PP}$	-	0.01	-	%

(5) Guaranteed by two points of Temperature $-40^\circ C$ and $+125^\circ C$

■ TYPICAL CHARACTERISTICS

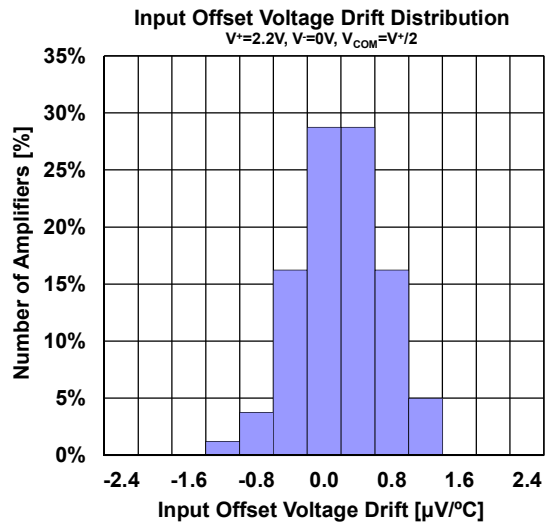
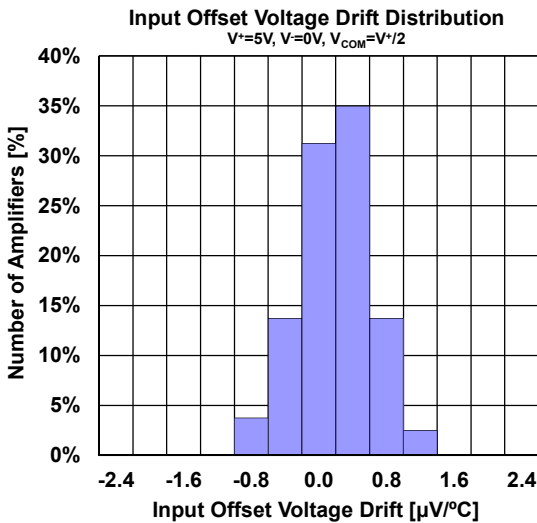
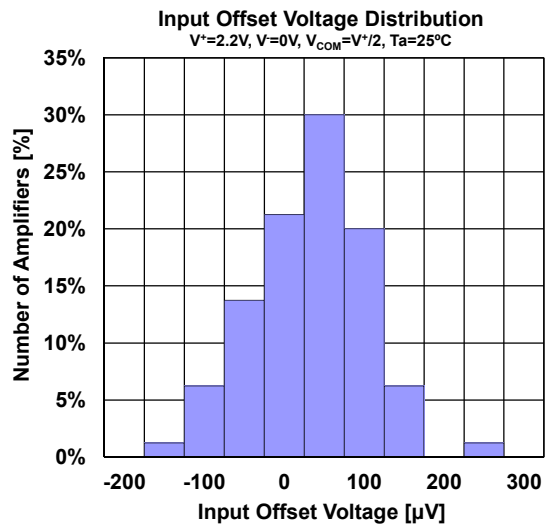
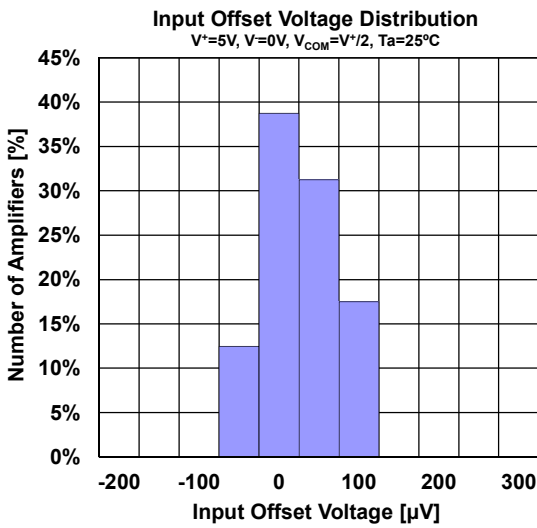
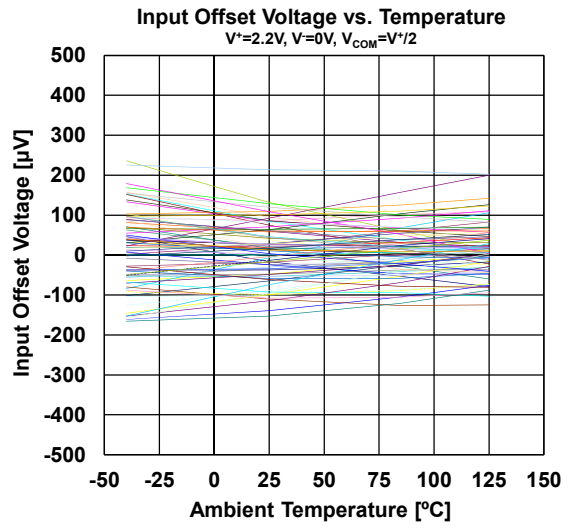
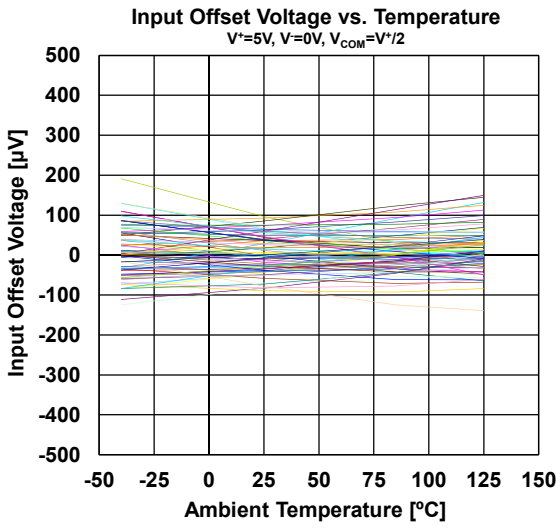

■ TYPICAL CHARACTERISTICS

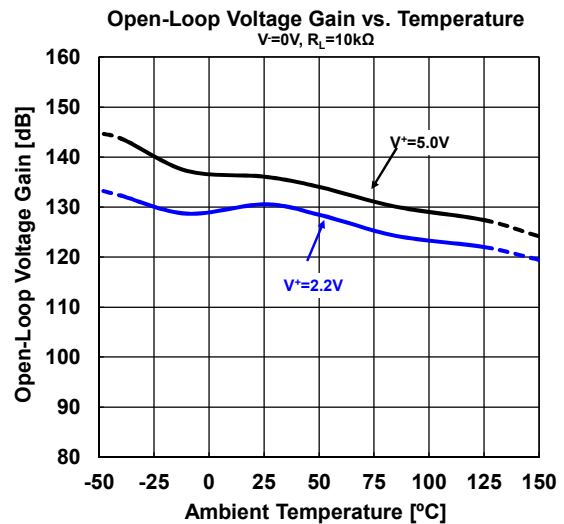
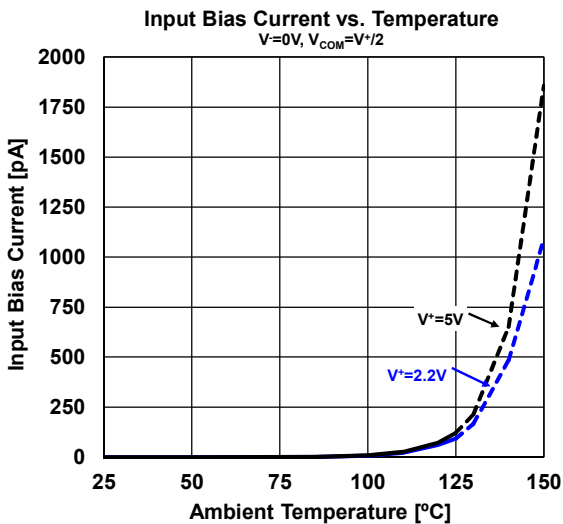
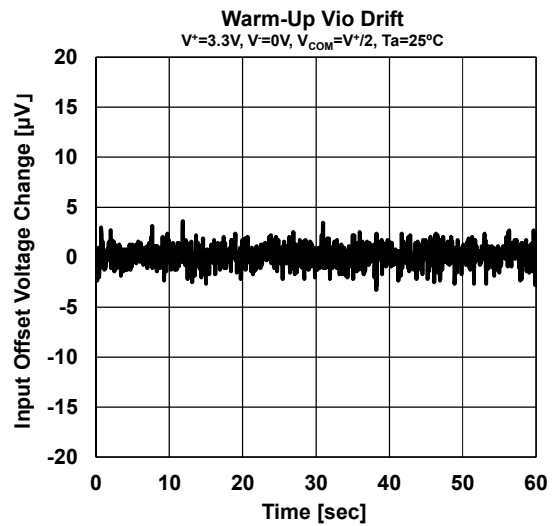
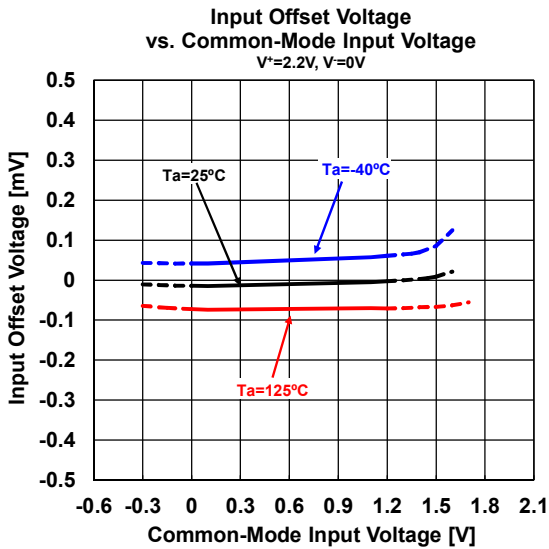
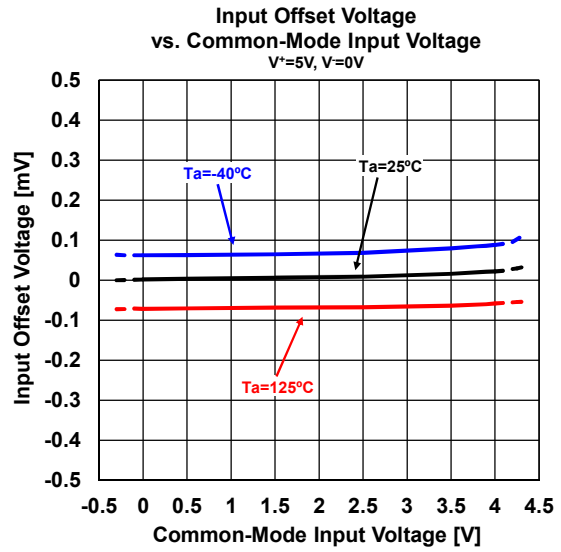
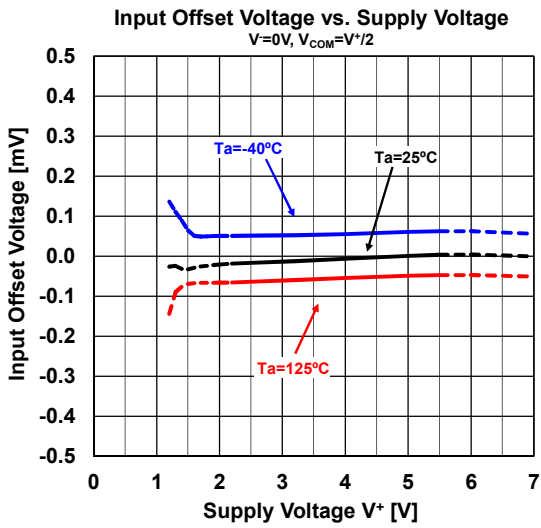

■ TYPICAL CHARACTERISTICS

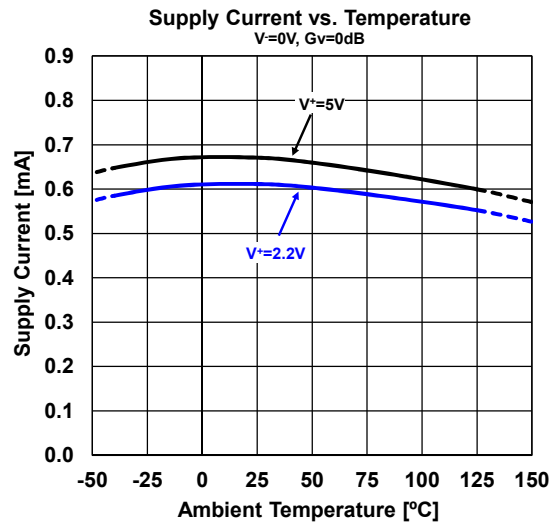
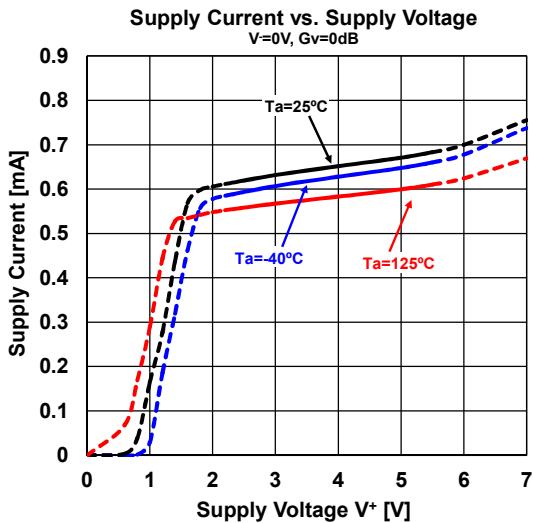
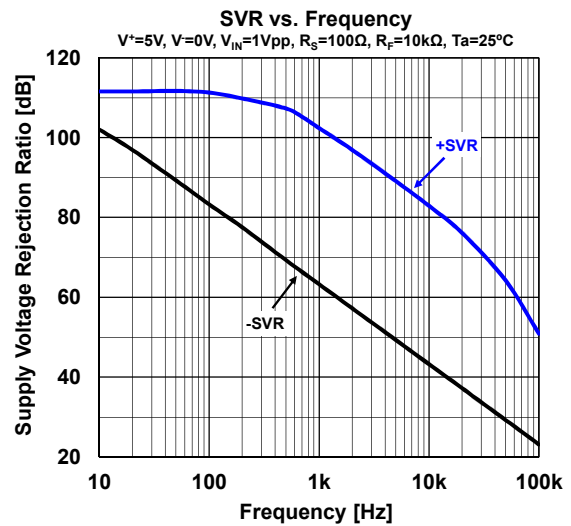
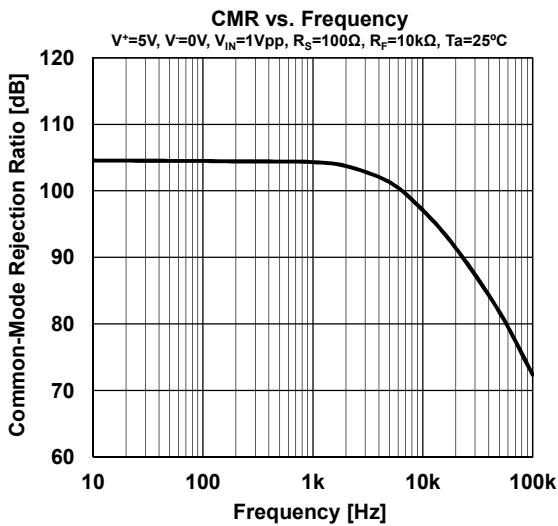
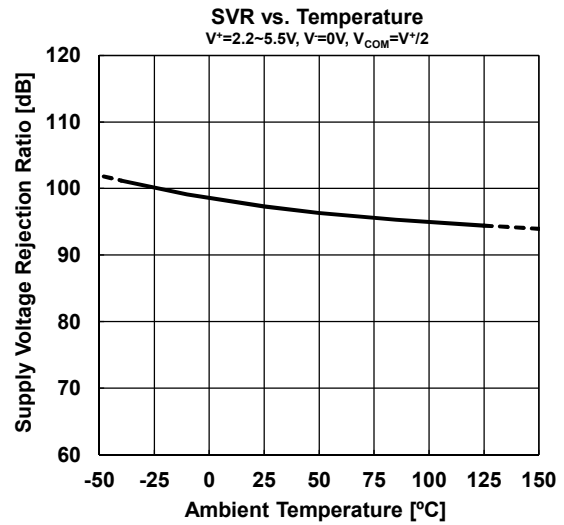
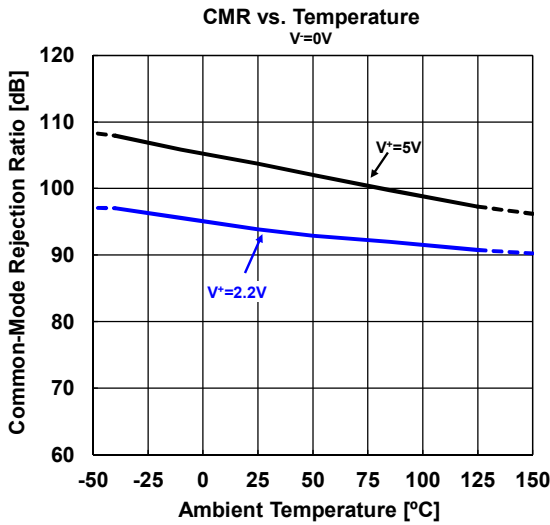

■ TYPICAL CHARACTERISTICS

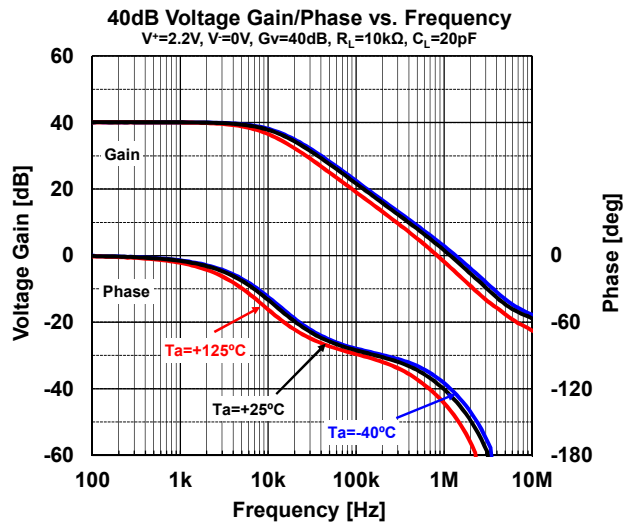
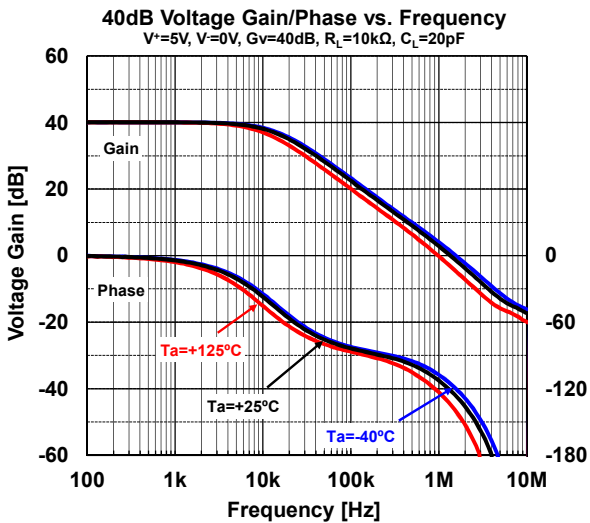
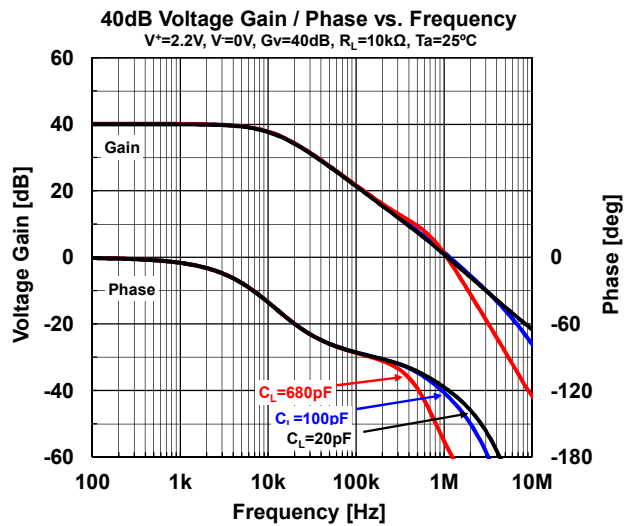
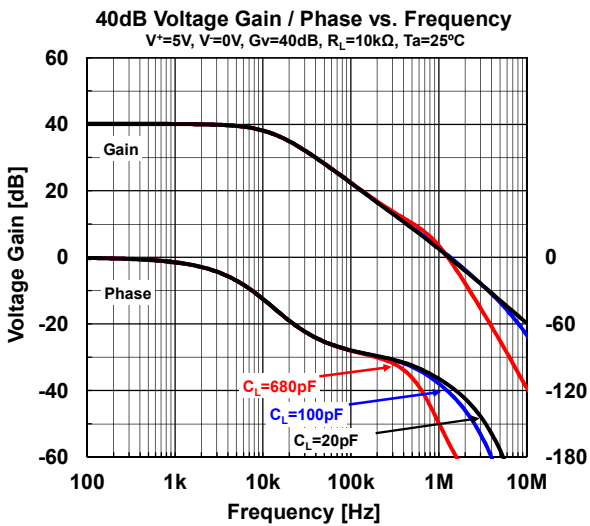
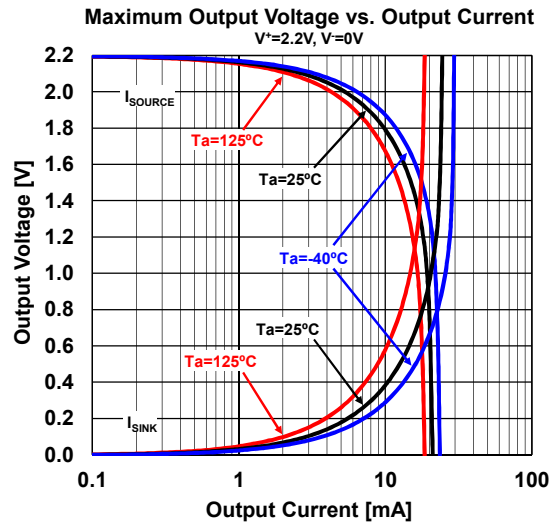
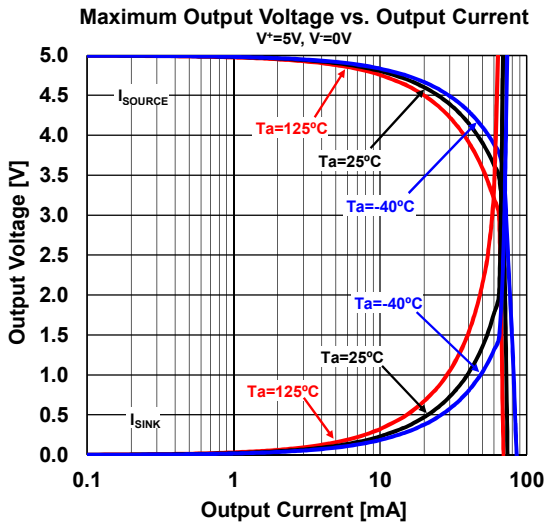

■ TYPICAL CHARACTERISTICS

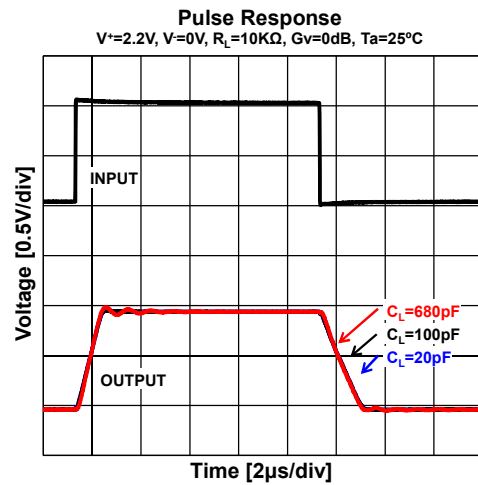
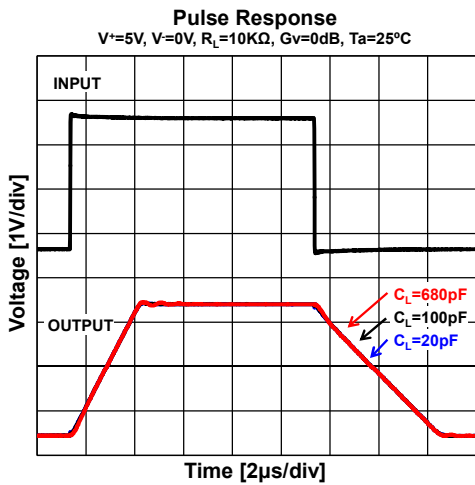
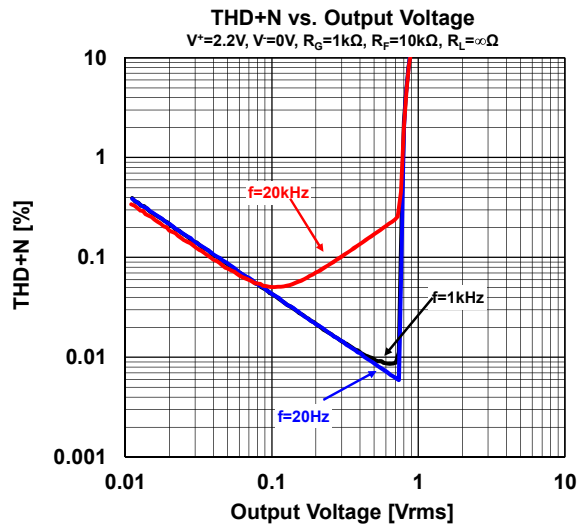
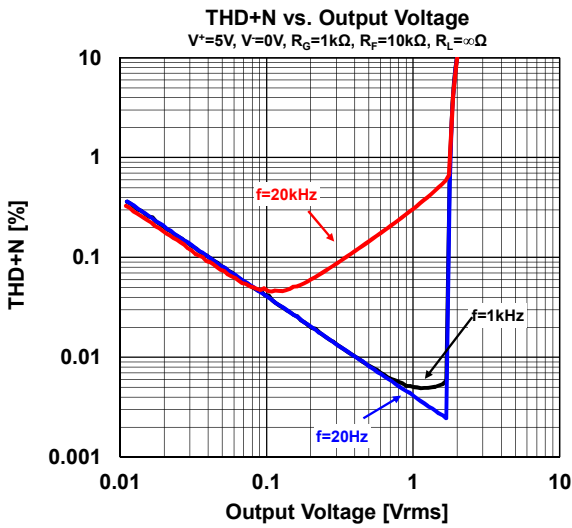
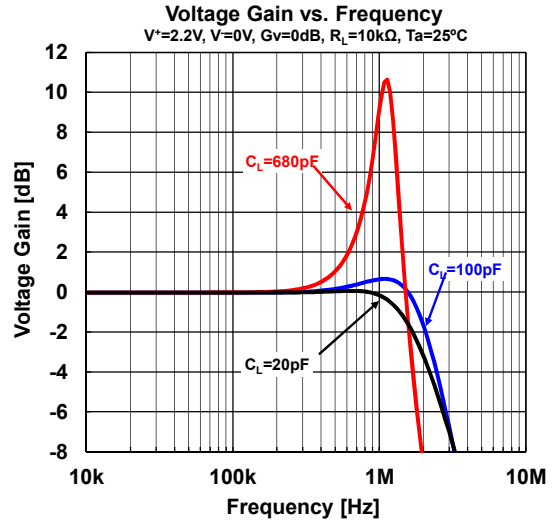
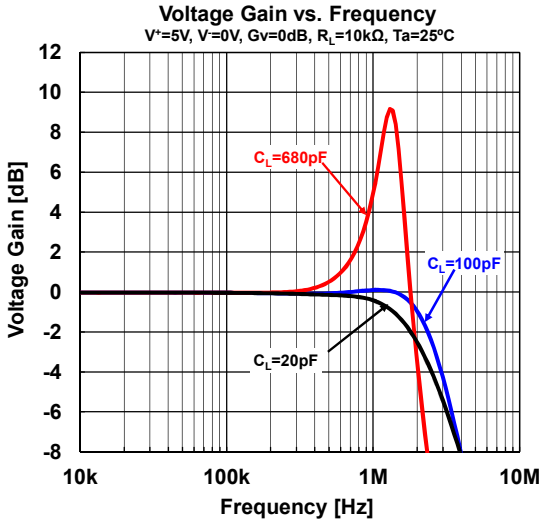

■ TYPICAL CHARACTERISTICS

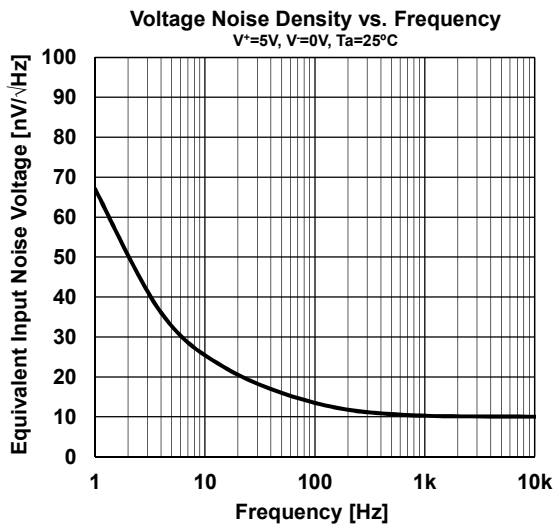

■ PACKAGE DIMENSIONS

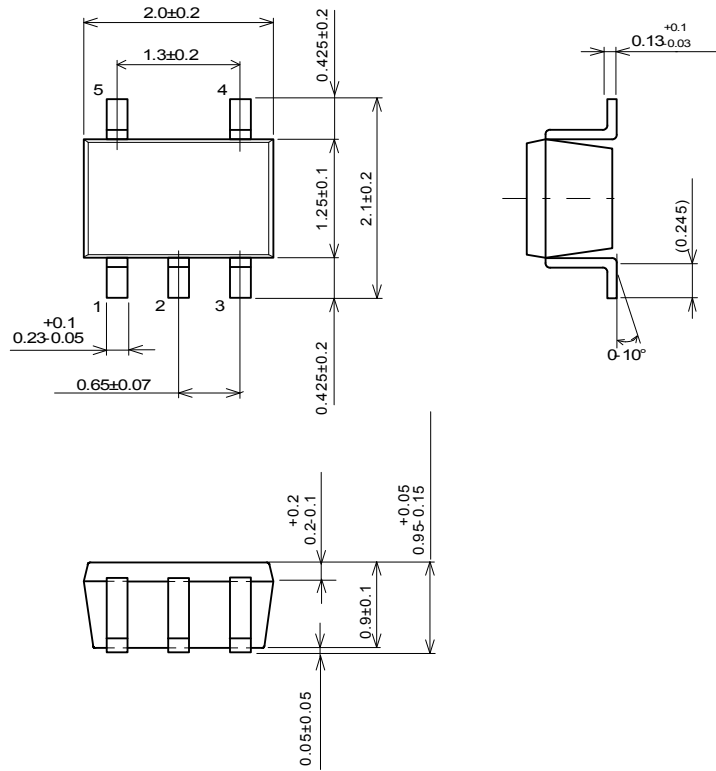

Unit: mm

SC-88A Package

[CAUTION]
 The specifications on this databook are only given for information, without any guarantee as regards either mistakes or omissions. The application circuits in this databook are described only to show representative usages of the product and not intended for the guarantee or permission of any right including the industrial right.