

13μA/ch, Rail-to-Rail Output CMOS Operational Amplifier

FEATURES (V⁺=5V, V⁻=0V, Ta=25°C, typ.)

- Supply Current (All Amplifiers)
 - NJU7026 13μA
 - NJU7027 26μA
 - NJU7028 48μA
- Supply Voltage 1.8V to 5.5V
- Gain Bandwidth Product 160kHz
- Rail-to-Rail Output
 - R_L=100kΩ to V⁺/2 50mV from rail
- Ground Sense
- Common-Mode Input Voltage Range 0V to 4.1V
- Input Offset Voltage 4mV max.
- Input Offset Voltage Drift 1.5μV/°C
- Thin and Ultra Small Package ESON8-U1
2.0 x 2.0 x 0.4 mm
- RF noise Immunity
- Unity-Gain Stable
- Package
 - NJU7026 SOT-23-5, SC-88A
 - NJU7027 MSOP8 (TVSP8)*
 - *meet JEDEC MO-187-DA / thin type
 - DFN8-U1(ESON8-U1)
 - NJU7028 SSOP14

APPLICATIONS

- Battery-powered instruments
- Current sensor amplifiers
- Voltage/current monitoring
- Power line monitoring
- Photodiode amplifiers

DESCRIPTION

The NJU7026/NJU7027/NJU7028 are single, dual and quad rail-to-rail output single supply CMOS operational amplifiers featuring low supply current.

These amplifiers operates from single 1.8V to 5.5V supply or dual ±0.9V to ±2.75V supply and provide a 160kHz gain-bandwidth products while using only 13μA of supply current per channel, ideal for 2-cell battery systems and 1-cell li-ion battery systems.

NJU7026/NJU7027/NJU7028 have rail-to-rail outputs that typically swing to within 50mV of the rails with 100kΩ load and the input common mode voltage range includes negative supply rail and swing to within 0.9V of the positive rail. These characteristics make them suited for low-side current sense applications.

In addition to low power and rail-to-rail output, very low bias current make them to used for photodiode amplifiers, charge amplifiers, piezoelectric sensors and other applications with high source impedance.

NJU7026/NJU7027/NJU7028 are high RF-immunity to reduce malfunctions caused by RF noises from mobile phones and others.

The NJU7026 is available in 5-pin SC-88A and SOT-23 package. NJU7027 is available in 8-pin MSOP (TVSP): meet JEDEC MO-187-DA / thin type package and DFN which is thin and 2mm square small package. NJU7028 is available in 14-pin SSOP package.

RELATED PRODUCTS

Features	Single	Dual	Quad
0.23μA/ch, Rail-to-rail I/O (Ultralow power type)	NJU77001 NJU77000	NJU77002	NJU77004
15nV/√Hz, Rail-to-rail Output (Low Noise type)	NJU7056	NJU7057	NJU7058
9V/μs, 5MHz, Rail-to-rail I/O (High slew rate type)	NJU7046	NJU7047	NJU7048

■ PIN CONFIGURATION / PRODUCT INFORMATION

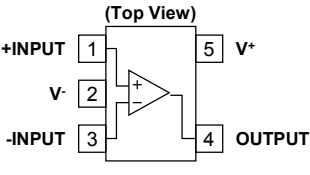
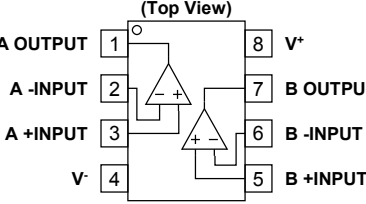
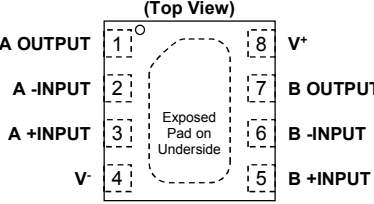
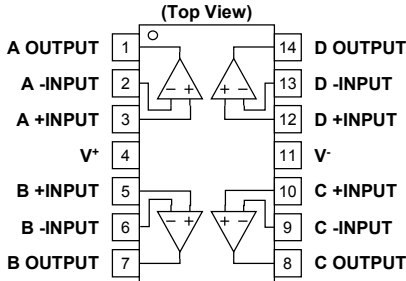
Pin Function					 <p>Connect to exposed pad to V-</p>
Package	 SC-88A	 SOT-23-5	 MSOP8(TVSP8)	 DFN8-U1(ESON8-U1)	
Product Name	NJU7026F3	NJU7026F	NJU7027RB1	NJU7027KU1	
Pin Function					
Package	 SSOP14				
Product Name	NJU7028V				

■ ABSOLUTE MAXIMUM RATINGS (Ta=25°C, unless otherwise noted.)

PARAMETER	SYMBOL	RATING	UNIT
Supply Voltage	$V^+ - V^-$	7	V
Input Voltage	V_{IN}	$V^- - 0.3$ to $V^+ + 0.3$	V
Differential Input Voltage ⁽¹⁾	V_{ID}	± 7 ⁽²⁾	V
Input Current ⁽³⁾	I_{IN}	10	mA
Power Dissipation ⁽⁴⁾	P_D	(2-layer / 4-layer) ⁽⁵⁾	
SOT-23-5		480 / 650	mW
SC-88A		360 / 490	
MSOP8(TVSP8)		510 / 680	
SSOP14		500 / 620	
DFN8-U1(ESON8-U1)	450 ⁽⁶⁾ / 1200 ⁽⁶⁾		
Operating Temperature Range	T_{opr}	-40 to +125	°C
Storage Temperature Range	T_{stg}	-55 to +150	°C

(1) Differential voltage is the voltage difference between +INPUT and -INPUT.

(2) For supply voltage less than +7V, the absolute maximum rating is equal to the supply voltage.

(3) Input voltages outside the supply voltage will be clamped by ESD protection diodes. If the input voltage exceeds the supply voltage, the input current must be limited 10 mA or less by using a restriction resistance.

(4) Power dissipation is the power that can be consumed by the IC at Ta=25°C, and is the typical measured value based on JEDEC condition. When using the IC over Ta=25°C subtract the value $[mW/°C]=P_D/(T_{stg}(MAX)-25)$ per temperature.

(5) 2-layer: EIA/JEDEC STANDARD Test board (76.2x114.3x1.6mm, 2layers, FR-4) mounting

4-layer: EIA/JEDEC STANDARD Test board (76.2x114.3x1.6mm, 4layers, FR-4) mounting

(6) 2-layer: EIA/JEDEC STANDARD Test board (101.5x114.5x1.6mm, 2layers, FR-4) mounting

4-layer: EIA/JEDEC STANDARD Test board (101.5x114.5x1.6mm, 4layers, FR-4) mounting

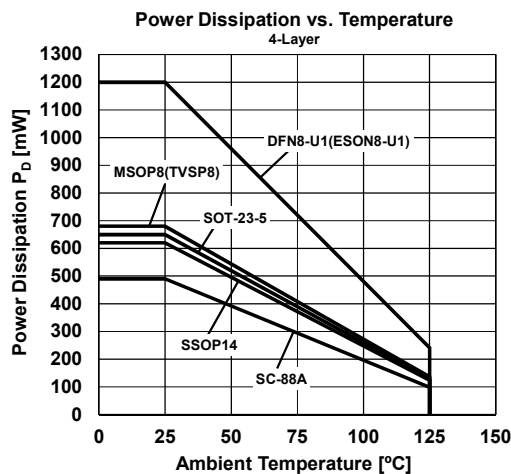
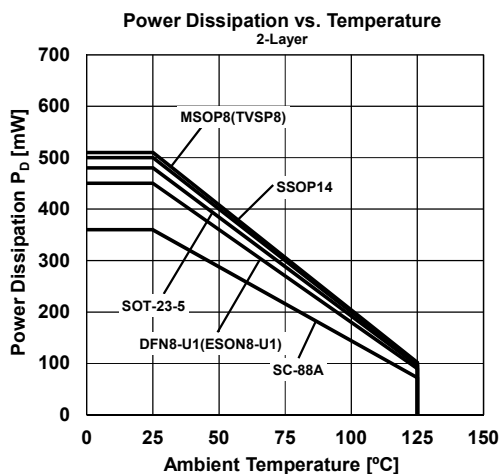

■ RECOMMENDED OPERATING CONDITIONS (Ta=25°C)

PARAMETER	CONDITION	MIN.	TYP.	MAX.	UNIT
Supply Voltage		1.8	-	5.5	V

■ ELECTRICAL CHARACTERISTICS ($V^+=5V$, $V^-=0V$, $T_a=25^\circ C$, unless otherwise noted.)

PARAMETER	SYMBOL	TEST CONDITION	MIN.	TYP.	MAX.	UNIT
DC CHARACTERISTICS						
Supply Current (All Amplifiers)	I_{SUPPLY}	No Signal	-	13	20	μA
NJU7026						
NJU7027						
NJU7028						
Input Offset Voltage	V_{IO}	$V_{COM}=0V$, $R_S=50\Omega$	-	0.9	4	mV
Input Offset Voltage Drift	$\Delta V_{IO}/\Delta T$	$T_a = -40^\circ C$ to $125^\circ C$	-	1.5	-	$\mu V/^\circ C$
NJU7026/NJU7027						
NJU7028						
Input Bias Current	I_B		-	1	-	pA
Input Offset Current	I_{IO}		-	1	-	pA
Open-Loop Voltage Gain	A_V	$R_L=100k\Omega$ to 2.5V, $V_{out}=0.5V$ to 4.5V	70	90	-	dB
Common-Mode Rejection Ratio	CMR	$V_{ICM}=0V$ to 4.1V	65	80	-	dB
Supply Voltage Rejection Ratio	SVR	$V^+=1.8V$ to 5.5V	70	90	-	dB
Common-Mode Input Voltage Range	V_{ICM}	CMR \geq 65dB	0	-	4.1	V
High-level Output Voltage	V_{OH}	$R_L=100k\Omega$ to 2.5V	4.9	4.95	-	V
		$R_L=100k\Omega$ to 0V	4.9	4.95	-	V
		$I_{SOURCE}=1mA$	4.8	4.85	-	V
Low-level Output Voltage	V_{OL}	$R_L=100k\Omega$ to 2.5V	-	0.05	0.1	V
		$R_L=100k\Omega$ to 0V	-	0.02	0.05	V
		$I_{SINK}=1mA$	-	0.15	0.2	V
AC CHARACTERISTICS						
Slew Rate ⁽⁷⁾	SR	$G_V=0dB$, $R_L=100k\Omega$ to 2.5V, $C_L=20pF$, $V_{IN}=3V_{PP}$	-	0.05	-	V/ μs
Gain Bandwidth Product	GBW	$R_L=100k\Omega$ to 2.5V, $C_L=20pF$, $f=10kHz$	-	160	-	kHz
Full Power Bandwidth	FPBW	$G_V=6dB$, $R_F=R_G=50k\Omega$, $C_L=20pF$, $V_{IN}=2.5V_{PP}$, $V_{out}\geq 4.8V_{PP}$	-	5	-	kHz
Phase Margin	Φ_M	$R_L=100k\Omega$ to 2.5V, $C_L=20pF$	-	80	-	deg
Gain Margin	G_M	$R_L=100k\Omega$ to 2.5V, $C_L=20pF$	-	15	-	dB
Equivalent Input Noise Voltage	V_{NI}	$f=1kHz$	-	50	-	nV/ \sqrt{Hz}
Total Harmonic Distortion + Noise	THD+N	$G_V=6dB$, $R_F=R_G=50k\Omega$, $C_L=20pF$, $V_O=4V_{PP}$, $f=100Hz$	-	0.01	-	%
Channel Separation	CS	$f=1kHz$, NJU7027/NJU7028	-	120	-	dB

(7) Slew rate is defined by the lower value of the rise or fall.

■ ELECTRICAL CHARACTERISTICS ($V^+=3V$, $V^-=0V$, $T_a=25^\circ C$, unless otherwise noted.)

PARAMETER	SYMBOL	TEST CONDITION	MIN.	TYP.	MAX.	UNIT
DC CHARACTERISTICS						
Supply Current (All Amplifiers)	I_{SUPPLY}	No Signal	-	12	19	μA
NJU7026			-	24	36	μA
NJU7027			-	45	68	μA
NJU7028						
Input Offset Voltage	V_{IO}	$V_{COM}=0V$, $R_S=50\Omega$	-	0.9	4	mV
Input Offset Voltage Drift	$\Delta V_{IO}/\Delta T$	$T_a = -40^\circ C$ to $125^\circ C$	-	1.5	-	$\mu V/^\circ C$
NJU7026/NJU7027			-	2	-	$\mu V/^\circ C$
NJU7028						
Input Bias Current	I_B		-	1	-	pA
Input Offset Current	I_{IO}		-	1	-	pA
Open-Loop Voltage Gain	A_V	$R_L=100k\Omega$ to 1.5V, $V_{out}=0.5V$ to 2.5V	70	90	-	dB
Common-Mode Rejection Ratio	CMR	$V_{ICM}=0V$ to 2.1V	65	80	-	dB
Supply Voltage Rejection Ratio	SVR	$V^+=1.8V$ to 5.5V	70	90	-	dB
Common-Mode Input Voltage Range	V_{ICM}	CMR \geq 65dB	0	-	2.1	V
High-level Output Voltage	V_{OH}	$R_L=100k\Omega$ to 1.5V	2.9	2.95	-	V
		$R_L=100k\Omega$ to 0V	2.9	2.95	-	V
		$I_{SOURCE}=1mA$	2.8	2.85	-	V
Low-level Output Voltage	V_{OL}	$R_L=100k\Omega$ to 1.5V	-	0.05	0.1	V
		$R_L=100k\Omega$ to 0V	-	0.02	0.05	V
		$I_{SINK}=1mA$	-	0.15	0.2	V
AC CHARACTERISTICS						
Slew Rate ⁽⁷⁾	SR	$G_V=0dB$, $R_L=100k\Omega$ to 1.5V, $C_L=20pF$, $V_{IN}=1V_{PP}$	-	0.05	-	V/ μs
Gain Bandwidth Product	GBW	$R_L=100k\Omega$ to 1.5V, $C_L=20pF$, $f=10kHz$	-	150	-	kHz
Full Power Bandwidth	FPBW	$G_V=6dB$, $R_F=R_G=50k\Omega$, $C_L=20pF$, $V_{IN}=1.5V_{PP}$, $V_{out}\geq 2.8V_{PP}$	-	8	-	kHz
Phase Margin	Φ_M	$R_L=100k\Omega$ to 1.5V, $C_L=20pF$	-	80	-	deg
Gain Margin	G_M	$R_L=100k\Omega$ to 1.5V, $C_L=20pF$	-	15	-	dB
Equivalent Input Noise Voltage	V_{NI}	$f=1kHz$	-	50	-	nV/ \sqrt{Hz}
Total Harmonic Distortion + Noise	THD+N	$G_V=6dB$, $R_F=R_G=50k\Omega$, $C_L=20pF$, $V_O=2V_{PP}$, $f=100Hz$	-	0.01	-	%
Channel Separation	CS	$f=1kHz$, NJU7027/NJU7028	-	115	-	dB

(7) Slew rate is defined by the lower value of the rise or fall.

■ ELECTRICAL CHARACTERISTICS ($V^+=1.8V$, $V^-=0V$, $T_a=25^\circ C$, unless otherwise noted.)

PARAMETER	SYMBOL	TEST CONDITION	MIN.	TYP.	MAX.	UNIT
DC CHARACTERISTICS						
Supply Current (All Amplifiers)	I_{SUPPLY}	No Signal	-	12	18	μA
NJU7026						
NJU7027						
NJU7028						
Input Offset Voltage	V_{IO}	$V_{COM}=0V$, $R_S=50\Omega$	-	0.9	4	mV
Input Offset Voltage Drift	$\Delta V_{IO}/\Delta T$	$T_a = -40^\circ C$ to $125^\circ C$	-	1.5	-	$\mu V/^\circ C$
NJU7026/NJU7027						
NJU7028				2	-	$\mu V/^\circ C$
Input Bias Current	I_B		-	1	-	pA
Input Offset Current	I_{IO}		-	1	-	pA
Open-Loop Voltage Gain	A_V	$R_L=100k\Omega$ to $0.9V$, $V_{out}=0.5V$ to $1.3V$	70	90	-	dB
Common-Mode Rejection Ratio	CMR	$V_{ICM}=0V$ to $0.9V$	65	80	-	dB
Supply Voltage Rejection Ratio	SVR	$V^+=1.8V$ to $5.5V$	70	90	-	dB
Common-Mode Input Voltage Range	V_{ICM}	CMR \geq 65dB	0	-	0.9	V
High-level Output Voltage	V_{OH}	$R_L=100k\Omega$ to $0.9V$	1.7	1.75	-	V
		$R_L=100k\Omega$ to $0V$	1.7	1.75	-	V
		$I_{SOURCE}=0.5mA$	1.5	1.55	-	V
Low-level Output Voltage	V_{OL}	$R_L=100k\Omega$ to $0.9V$	-	0.05	0.1	V
		$R_L=100k\Omega$ to $0V$	-	0.02	0.05	V
		$I_{SINK}=0.5mA$	-	0.25	0.3	V
AC CHARACTERISTICS						
Slew Rate ⁽⁷⁾	SR	$G_V=0dB$, $R_L=100k\Omega$ to $0V$, $C_L=20pF$, $V_{IN}=0.5V_{PP}$	-	0.05	-	V/ μs
Gain Bandwidth Product	GBW	$R_L=100k\Omega$ to $0.9V$, $C_L=20pF$, $f=10kHz$	-	140	-	kHz
Full Power Bandwidth	FPBW	$G_V=6dB$, $R_F=R_G=50k\Omega$, $C_L=20pF$, $V_{IN}=0.9V_{PP}$, $V_{out}\geq 1.6V_{PP}$	-	14	-	kHz
Phase Margin	Φ_M	$R_L=100k\Omega$ to $0.9V$, $C_L=20pF$	-	80	-	deg
Gain Margin	G_M	$R_L=100k\Omega$ to $0.9V$, $C_L=20pF$	-	15	-	dB
Equivalent Input Noise Voltage	V_{NI}	$f=1kHz$	-	50	-	nV/ \sqrt{Hz}
Total Harmonic Distortion + Noise	THD+N	$G_V=6dB$, $R_F=R_G=50k\Omega$, $C_L=20pF$, $V_O=1V_{PP}$, $f=100Hz$	-	0.01	-	%
Channel Separation	CS	$f=1kHz$, NJU7027/NJU7028	-	110	-	dB

(7) Slew rate is defined by the lower value of the rise or fall.

■ TYPICAL CHARACTERISTICS

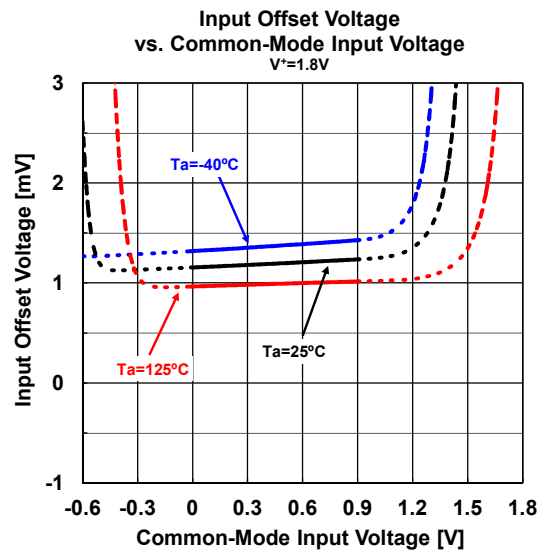
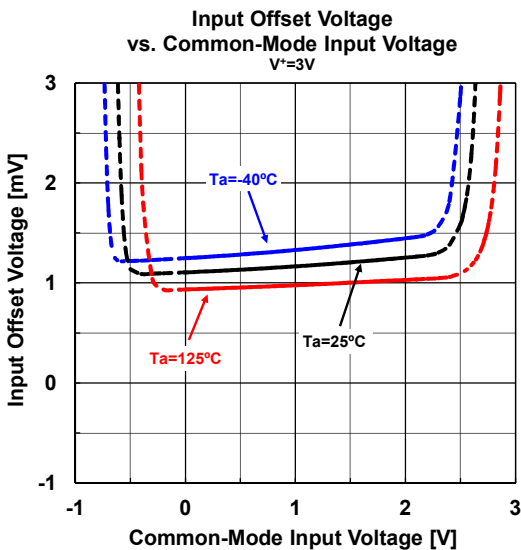
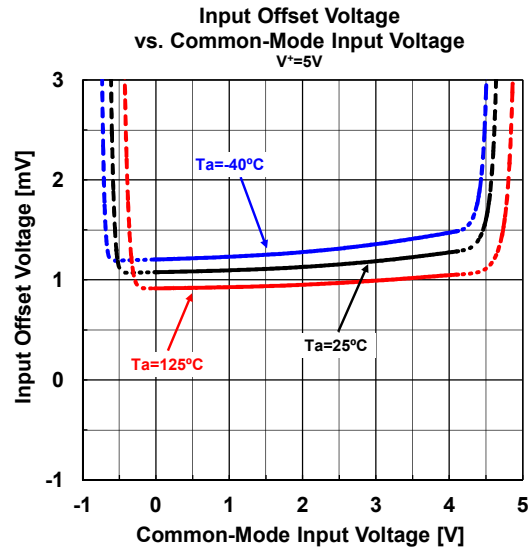
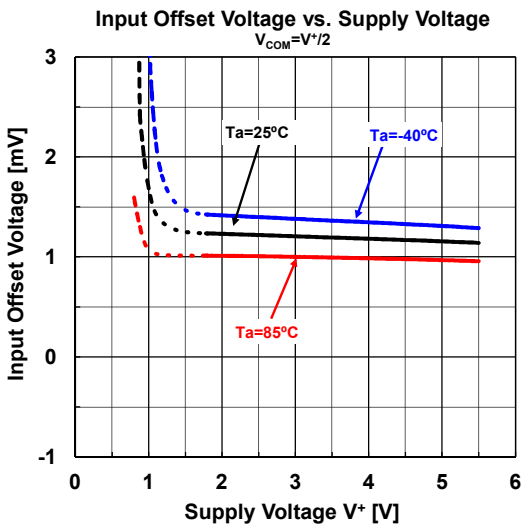
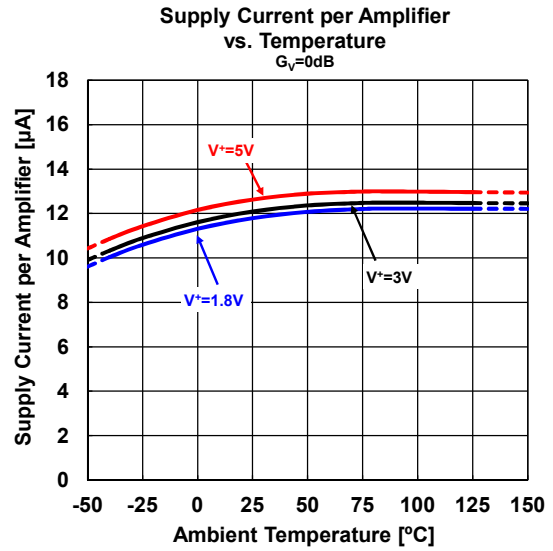
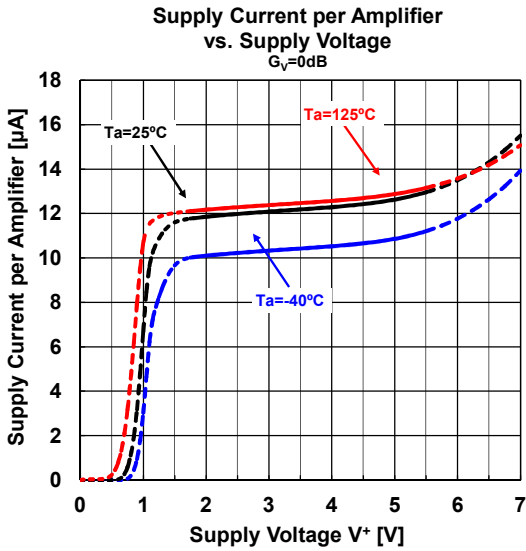

■ TYPICAL CHARACTERISTICS

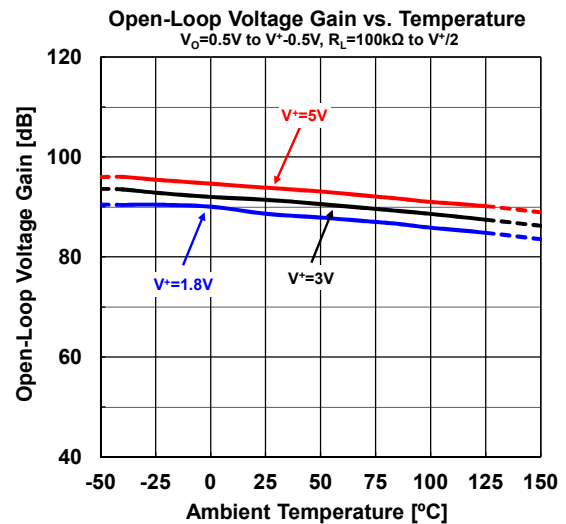
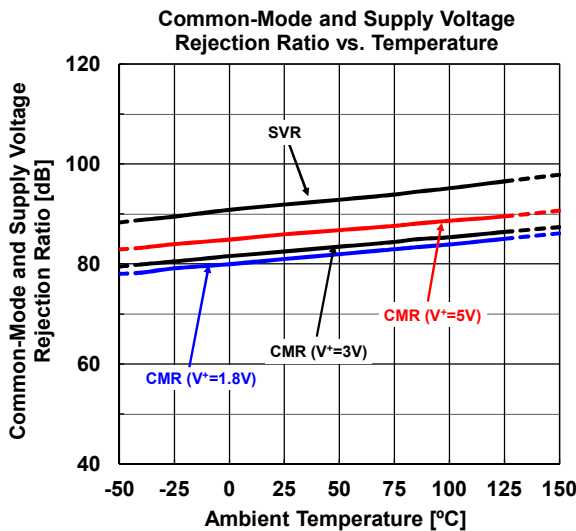
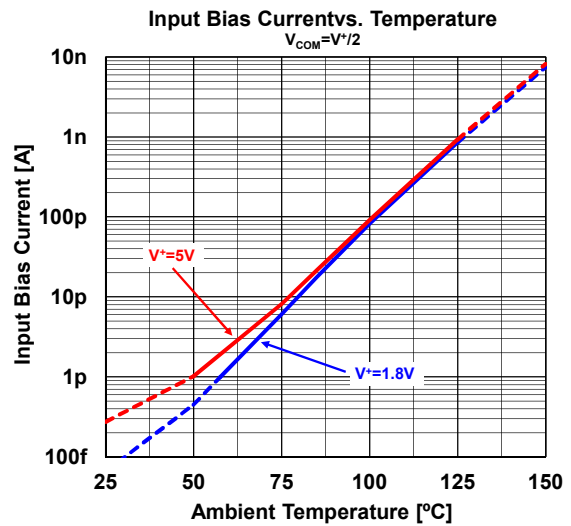
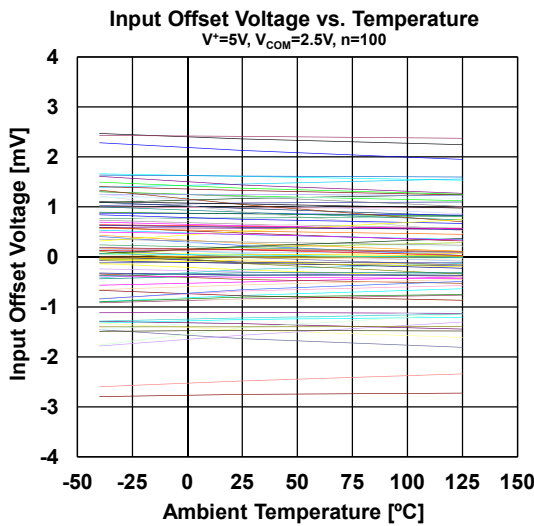
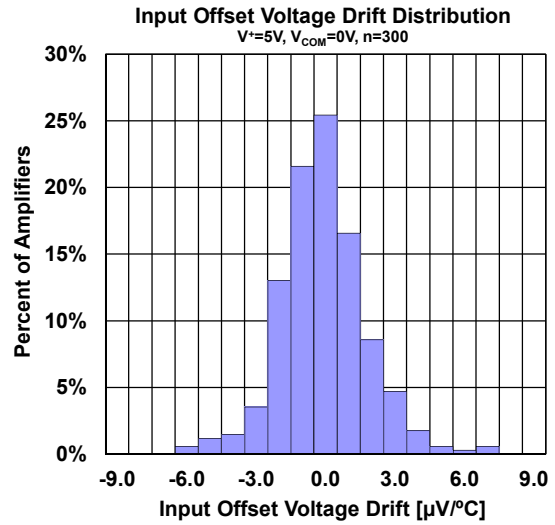
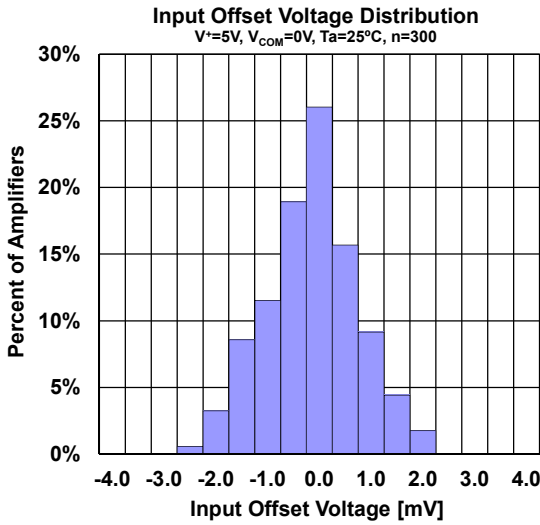

■ TYPICAL CHARACTERISTICS

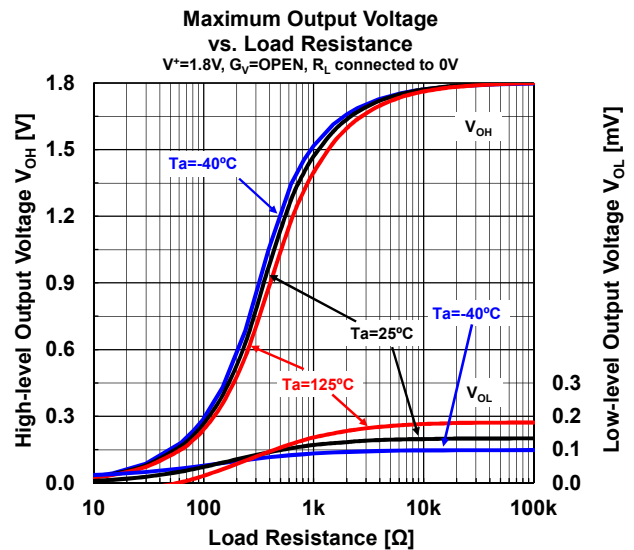
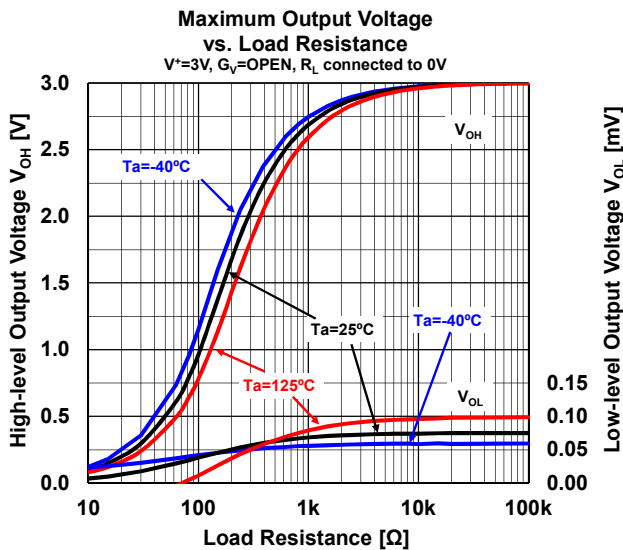
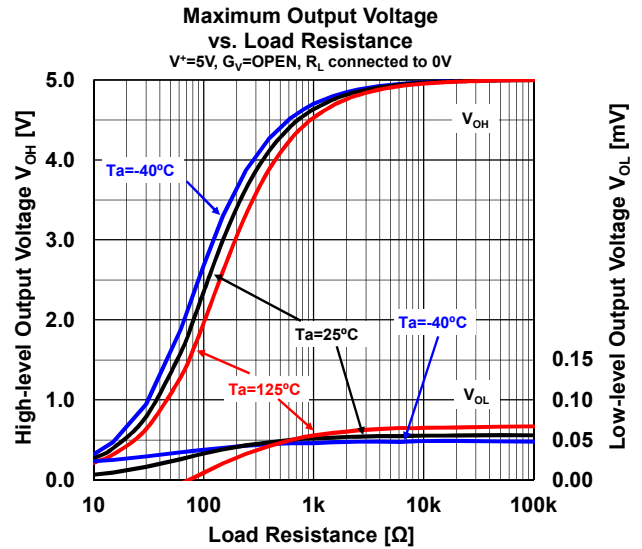
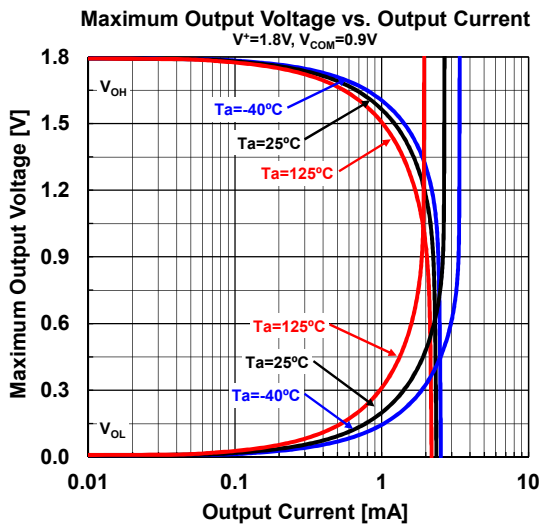
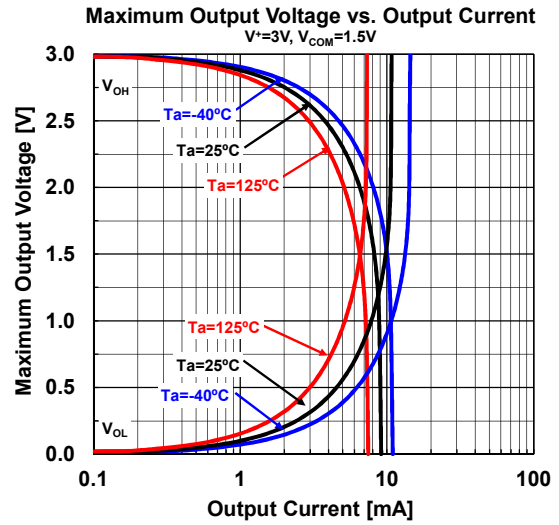
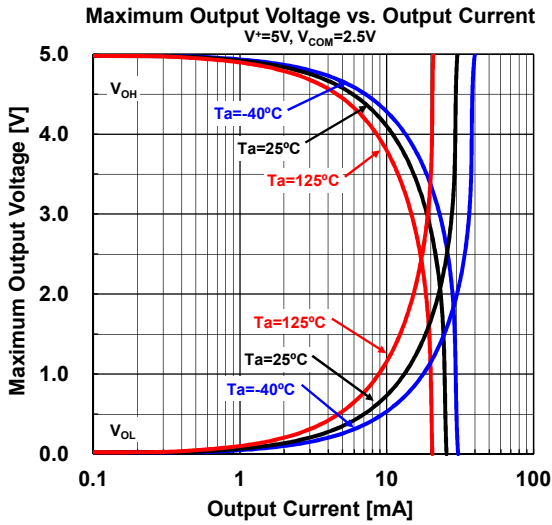

TYPICAL CHARACTERISTICS

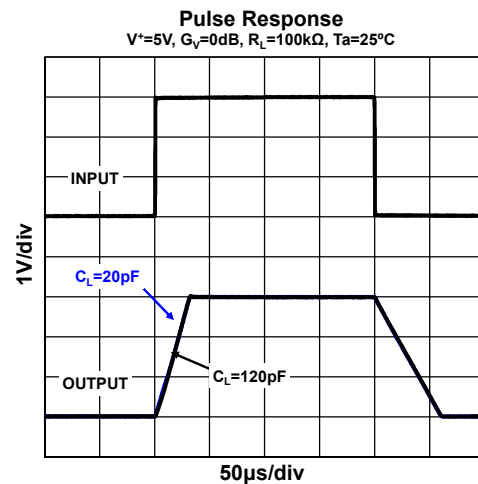
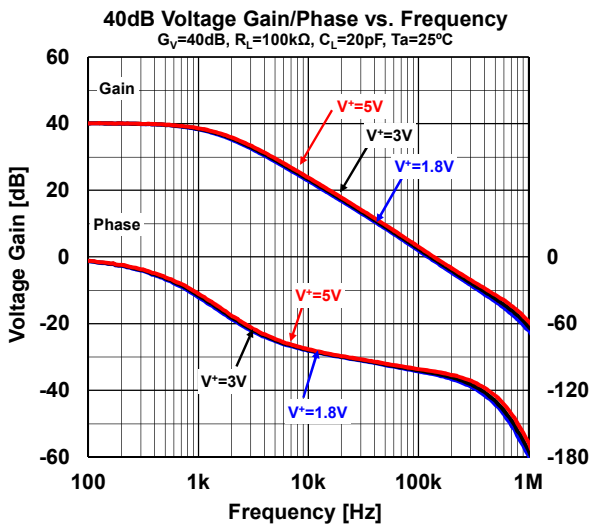
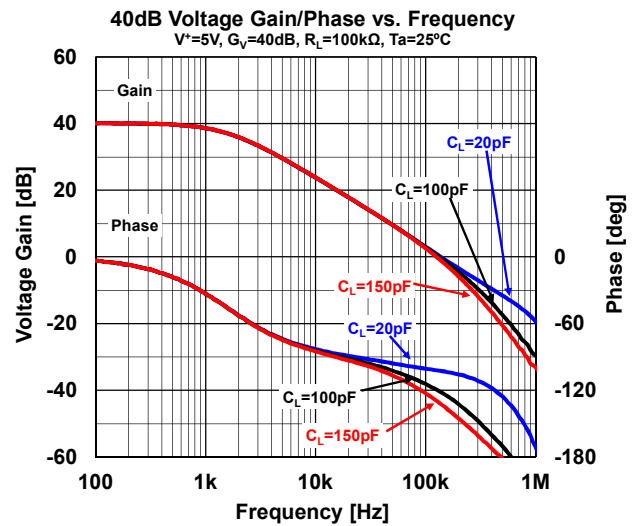
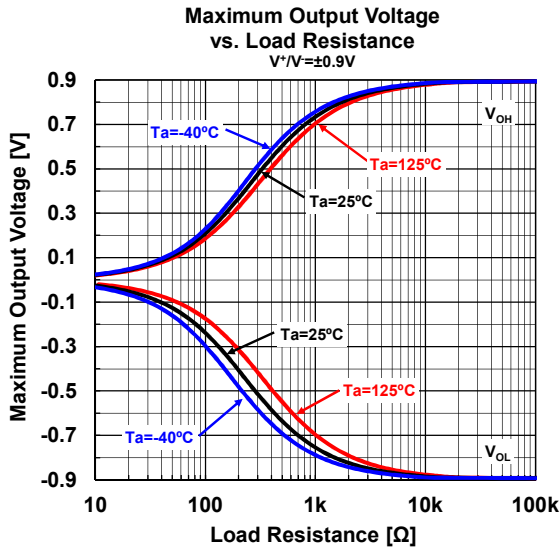
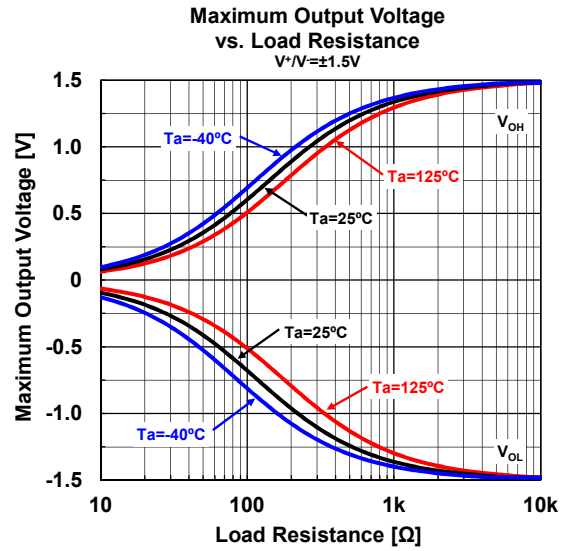
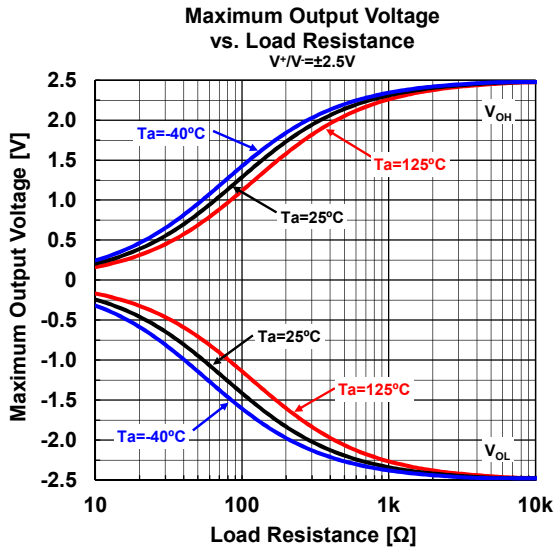

■ TYPICAL CHARACTERISTICS

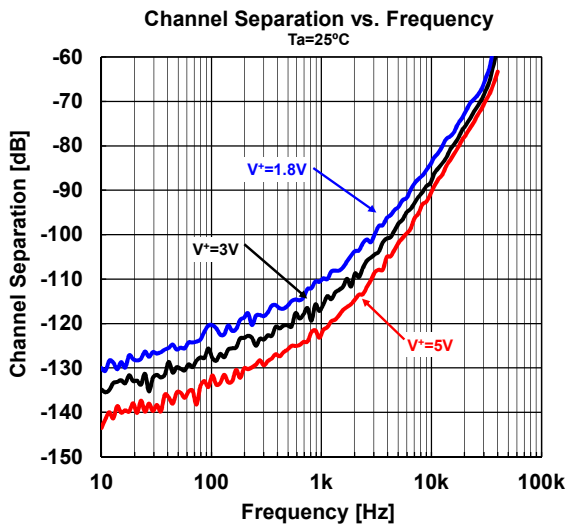
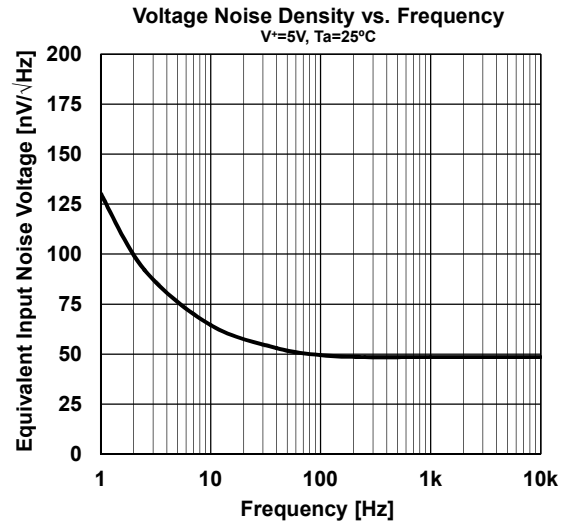
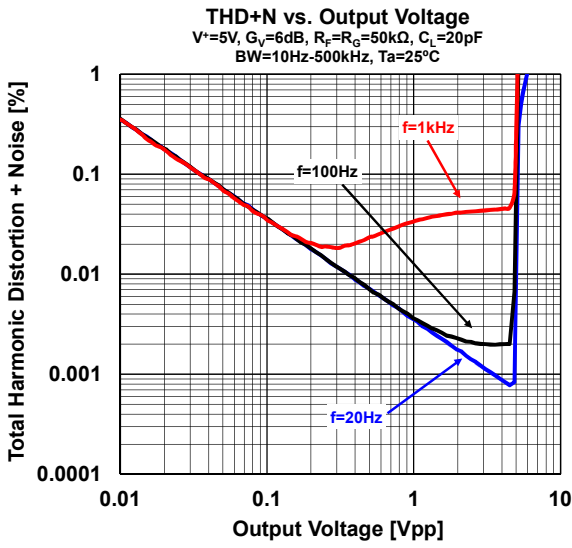

APPLICATION NOTE

Single and Dual Supply Voltage Operation

The NJU7026/NJU7027/NJU7028 works with both single supply and dual supply when the voltage supplied is between V^+ and V^- . These amplifiers operate from single 1.8 to 5.5V supply and dual $\pm 0.9V$ to $\pm 2.75V$ supply.

Common-Mode Input Voltage Range

When the supply voltage does not meet the condition of electrical characteristics, the range of common-mode input voltage is as follows:

$$V_{ICM} \text{ (typ.)} = V^- \text{ to } V^+ - 0.9 \text{ (Ta} = 25^\circ\text{C)}$$

Difference of V_{ICM} when Temperature change, refer to typical characteristic graph.

During designing, consider variations in characteristics for use with allowance.

Maximum Output Voltage Range

When the supply voltage does not meet the condition of electrical characteristics, the range of the typ. value of the maximum output voltage is as follows:

$$V_{OM} \text{ (typ.)} = V^+ - 50\text{mV to } V^- + 50\text{mV} \\ (R_L = 100\text{k}\Omega \text{ to } V^+/2, \text{ Ta} = 25^\circ\text{C})$$

During designing, consider variations in characteristics and temperature characteristics for use with allowance. In addition, also note that the output voltage range becomes narrow as shown in typical characteristics graph when an output current increases.

Input Voltage Exceeding the Supply Voltage

Inputs of the NJU7026/NJU7027/NJU7028 are protected by ESD diodes (shown in Figure1) that will conduct if the input voltages exceed the power supplies by more than approximately 300mV. Momentary voltages greater than 300mV beyond the power supply, inputs can be tolerated if the current is limited to 10mA. Figure2 is easily accomplished with an input resistor. If the input voltage exceeds the supply voltage, the input current must be limited 10mA or less by using a restriction resistance (R_{LIMIT}) as shown in figure2.

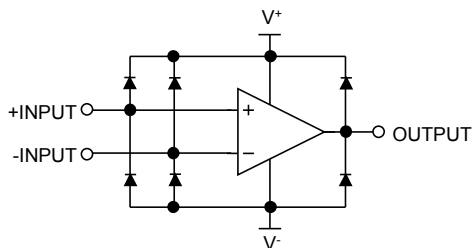

Figure1. Simplified Schematic

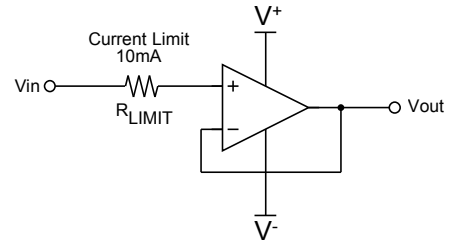

Figure2. Input Current Protection for Voltages exceeding the Supply Voltage.

Capacitive load

The NJU7026/NJU7027/NJU7028 can use at unity gain follower, but the unity gain follower is the most sensitive configuration to capacitive loading. The combination of capacitive load placed directly on the output of an amplifier along with the output impedance of the amplifier creates a phase lag which in turn reduces the phase margin of the amplifier. If phase margin is significantly reduced, the response will cause overshoot and ringing in the step response. The NJU7026/NJU7027/NJU7028 is unity gain stable for capacitive loads of 220pF. To drive heavier capacitive loads, an isolation resistor, R_{ISO} as shown Figure3, should be used. R_{ISO} improves the feedback loop's phase margin by making the output load resistive at higher frequencies. The larger the value of R_{ISO} , the more stable the output voltage will be. However, larger values of R_{ISO} result in reduced output swing, reduced output current drive and reduced frequency bandwidth.

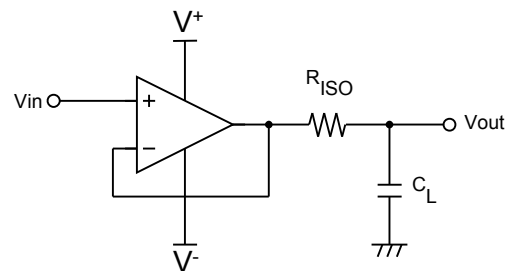
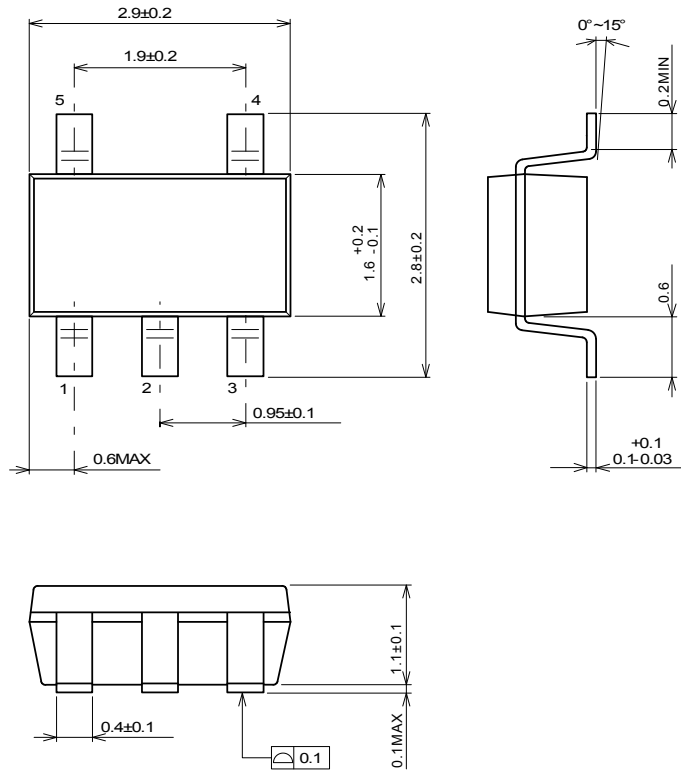

Figure3. Isolating capacitive load

■ PACKAGE DIMENSIONS



Unit: mm

SOT-23-5 Package

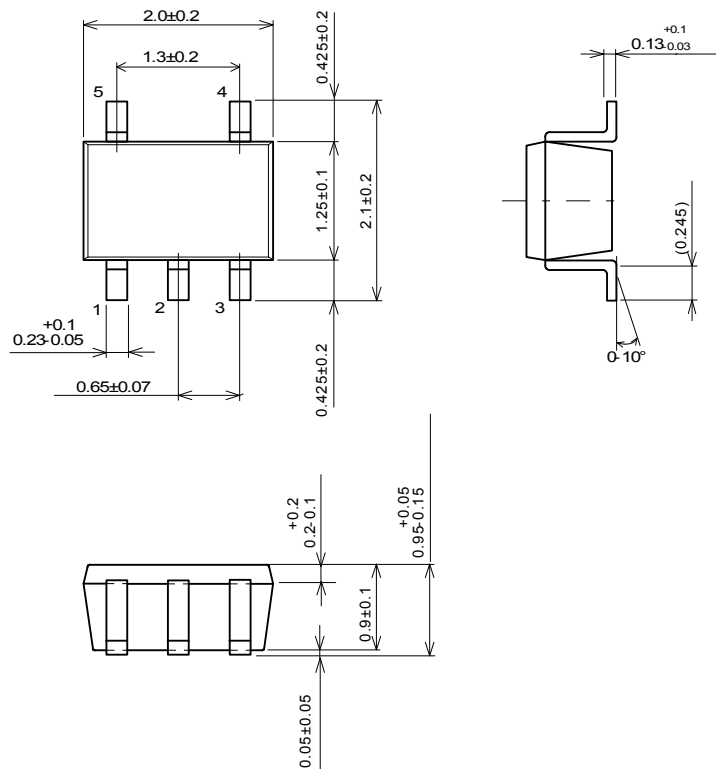

Unit: mm

SC-88A Package

■ PACKAGE DIMENSIONS

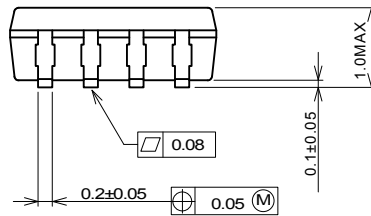
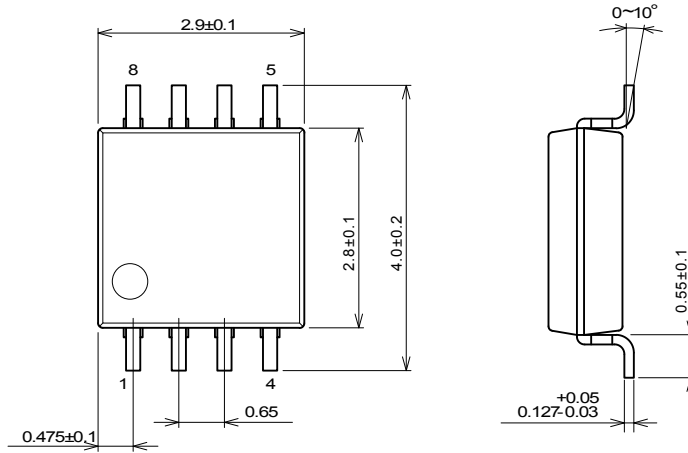

Unit: mm

MSOP8 (TVSP8) Package
meet JEDEC MO-187-DA / thin

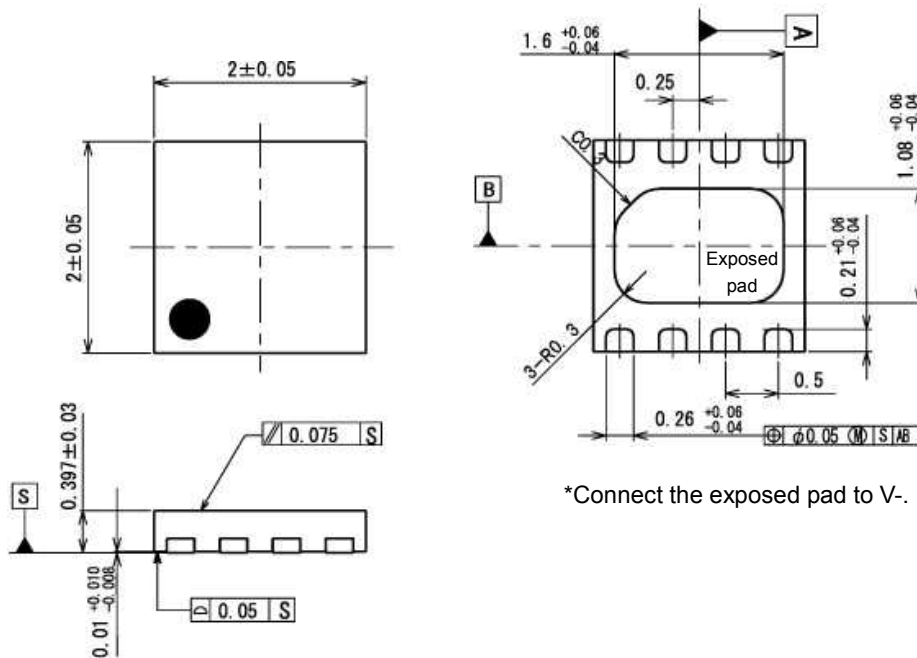

*Connect the exposed pad to V-

Unit: mm

DFN8-U1 (ESON8-U1) Package

■ PACKAGE DIMENSIONS

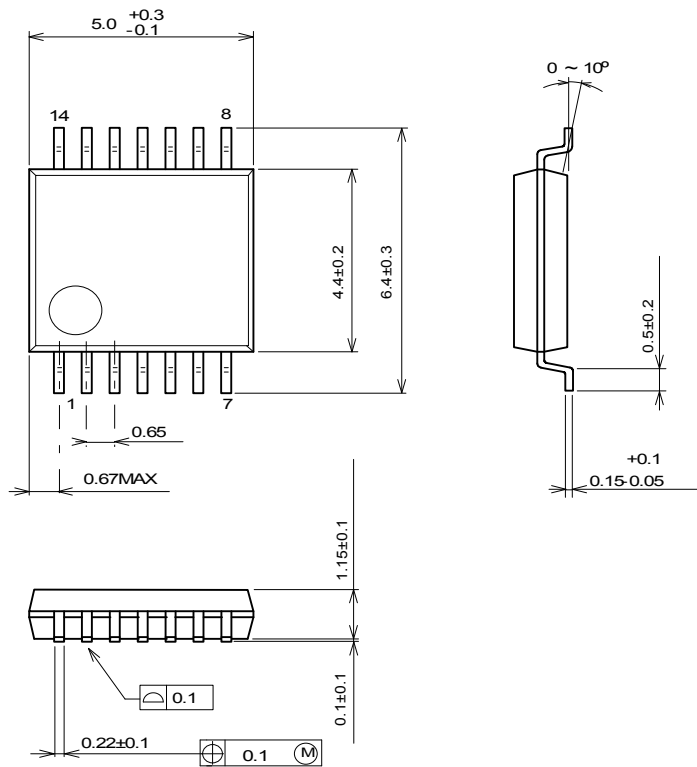

Unit: mm

SSOP14 Package

[CAUTION]
 The specifications on this databook are only given for information, without any guarantee as regards either mistakes or omissions. The application circuits in this databook are described only to show representative usages of the product and not intended for the guarantee or permission of any right including the industrial rights.