

Precision, Dual, JFET Input Operational Amplifier

■ FEATURES

- Low Input Offset Voltage $V_{IO}=400\mu\text{V}$ max.
 $V_{IO}=700\mu\text{V}$ max. ($T_a = -40^\circ\text{C}$ to $+125^\circ\text{C}$)
- Low Input Offset Voltage Drift $\Delta V_{IO}/\Delta T=10\mu\text{V}/^\circ\text{C}$ max. ($T_a = -40^\circ\text{C}$ to $+125^\circ\text{C}$)
- Small Package MSOP8(VSP8) MEET JEDEC MO-187-DA
- Low Supply Current $I_{CC}=3\text{mA}$ max.
- High Slew Rate $SR=20\text{V}/\mu\text{s}$ typ.
- Wide Bandwidth $GBP=7\text{MHz}$ typ.
- Low Noise $e_n=10\text{nV}/\sqrt{\text{Hz}}$ at $f=1\text{kHz}$ typ.
- Low Input Bias Current $I_B=80\text{pA}$ max. at $T_a=25^\circ\text{C}$
- No Phase Reversal
- Guaranteed Temperature $T_{opr} = -40^\circ\text{C}$ to $+125^\circ\text{C}$
- Operating Voltage $V_{opr} = \pm 4.5\text{V}$ to $\pm 16\text{V}$

■ PACKAGE OUTLINE



NJM8502R
(MSOP8(VSP8))

■ GENERAL DESCRIPTION

The NJM8502 is a dual high precision JFET input operational amplifier featuring low offset, low offset drift, low bias current, high slew rate, low noise and wide operating temperature range.

The precision performance, high speed and low noise make the NJM8502 especially suitable for filter and amplification of high speed and small signal in instruments, automated test equipment, sensors and other precision applications.

■ APPLICATIONS

- Current Sensor
- Photodiode Amplification
- Reference Voltage Circuit
- Automatic Test Equipment

■ PIN CONFIGURATION

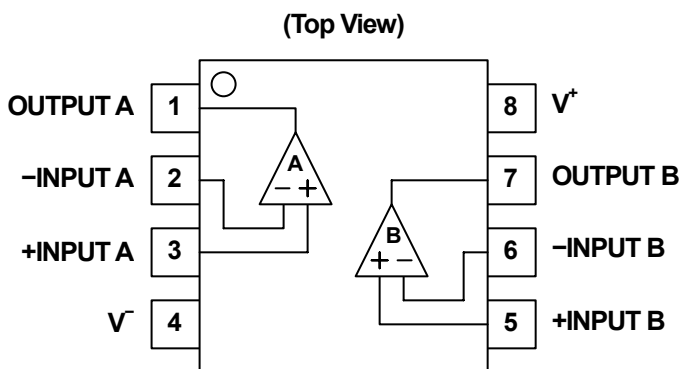

■ PACKAGE DESCRIPTION

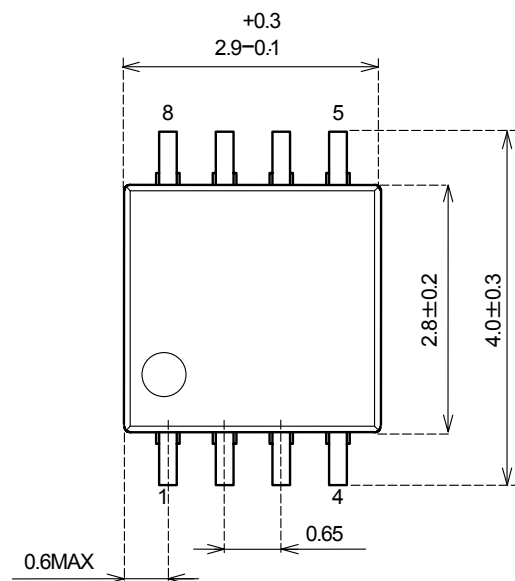

NJM8502

■ ABSOLUTE MAXIMUM RATINGS (Ta=25°C, unless otherwise noted.)

PARAMETER	SYMBOL	RATING	UNIT
Supply Voltage	V^+V	±18	V
Differential Input Voltage	V_{ID}	±36 (note1)	V
Input Voltage	V_{IN}	$V - 0.3$ to $V + 36$ (note2)	V
Input Current	I_{IN}	±10	mA
Power Dissipation MSOP8 (VSP8)	P_D	(2-layer / 4-layer) 595(note3) / 805(note3)	mW
Duration of short-circuit		Unlimited (Ta ≤ 25°C) (note3)	
Operating Temperature Range	T_{opr}	-40 to +125	°C
Storage Temperature Range	T_{stg}	-65 to +150	°C

(Note1) Differential Input Voltage is the voltage difference between +INPUT and -INPUT.

(Note2) The normal operation will establish when any input is within the Common Mode Input Voltage Range of electrical characteristics.

(Note3) 2-layer : EIA/JEDEC STANDARD Test board (76.2 x 114.3 x 1.6mm, 2layers, FR-4) mounting.

4-layer : EIA/JEDEC STANDARD Test board (76.2 x 114.3 x 1.6mm, 4layers, FR-4) mounting.

See Figure "Fig.1-1 : Power Dissipation Curve" when ambient temperature is over 25°C.

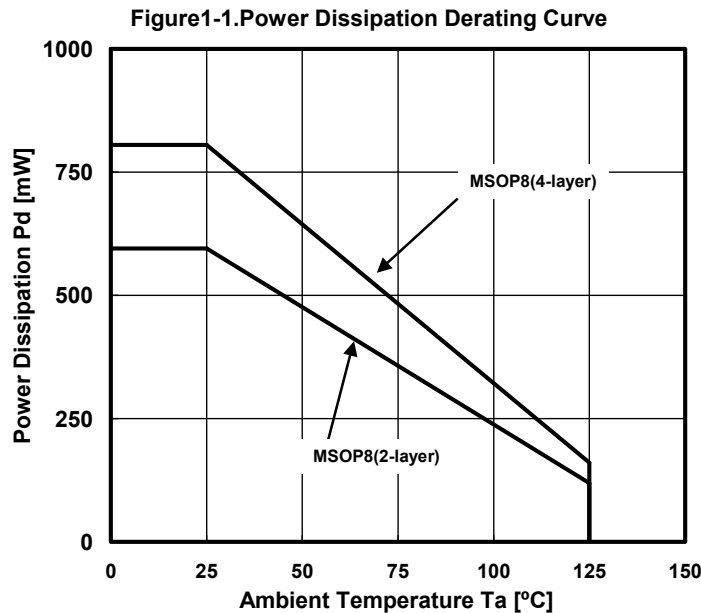

■ RECOMMENDED OPERATING VOLTAGE

PARAMETER	SYMBOL	RATING	MIN	TYP	MAX	UNIT
Supply Voltage	V^+V		±4.5	-	±16	V

■ ELECTRICAL CHARACTERISTICS

●DC CHARACTER ($V^+ / V^- = \pm 15V$, $T_a = 25^\circ C$, $V_{ICM} = 0V$, unless otherwise noted.)

PARAMETER	SYMBOL	TEST CONDITION	MIN.	TYP.	MAX.	UNIT
Input Characteristics						
Input Offset Voltage	V_{IO1}		-	80	400	μV
	V_{IO2}	$T_a = -40^\circ C$ to $+125^\circ C$	-	-	700	μV
Input Offset Voltage Drift (Note5)	$\Delta V_{IO} / \Delta T$	$T_a = -40^\circ C$ to $+125^\circ C$	-	1.0	10	$\mu V / ^\circ C$
Input Bias Current	I_{B1}		-	25	80	pA
	I_{B2}	$T_a = -40^\circ C$ to $+125^\circ C$	-	-	35	nA
Input Offset Current	I_{IO1}		-	6	75	pA
	I_{IO2}	$T_a = -40^\circ C$ to $+125^\circ C$	-	-	2	nA
Common Mode Input Voltage Range	V_{ICM1}	$CMR \geq 86dB$	-12.5	-	+12.5	V
	V_{ICM2}	$CMR \geq 80dB$, $T_a = -40^\circ C$ to $+125^\circ C$	-12.5	-	+12.5	V
Common Mode Rejection Ratio	CMR1	$V_{CM} = -12.5V$ to $+12.5V$	86	108	-	dB
	CMR2	$V_{CM} = -12.5V$ to $+12.5V$, $T_a = -40^\circ C$ to $+125^\circ C$	80	-	-	dB
Voltage Gain	A_{v1}	$R_L = 2k\Omega$, $V_o = -13.5V$ to $+13.5V$	90	100	-	dB
	A_{v2}	$R_L = 2k\Omega$, $V_o = -13.5V$ to $+13.5V$, $T_a = -40^\circ C$ to $+125^\circ C$	82	-	-	dB
Channel Separation	CS	DC	-	125	-	dB
Output Characteristics						
Maximum Output Voltage	V_{OH1}	$R_L = 10k\Omega$, $T_a = -40^\circ C$ to $+125^\circ C$	+14.0	+14.2	-	V
	V_{OL1}	$R_L = 10k\Omega$, $T_a = -40^\circ C$ to $+125^\circ C$	-	-14.9	-14.6	V
	V_{OH2}	$R_L = 2k\Omega$, $T_a = -40^\circ C$ to $+125^\circ C$	+13.8	+14.1	-	V
	V_{OL2}	$R_L = 2k\Omega$, $T_a = -40^\circ C$ to $+125^\circ C$	-	-14.8	-14.4	V
	V_{OH31}	$R_L = 600\Omega$	+13.5	+13.9	-	V
	V_{OH32}	$R_L = 600\Omega$, $T_a = -40^\circ C$ to $+125^\circ C$	+11.4	-	-	V
	V_{OL41}	$R_L = 600\Omega$	-	-14.3	-13.8	V
	V_{OL42}	$R_L = 600\Omega$, $T_a = -40^\circ C$ to $+125^\circ C$	-	-	-12.1	V
Supply Characteristics						
Quiescent Current	I_{CC1}	$G_V = +1$, $R_L = \infty$	-	2.6	3.0	mA
	I_{CC2}	$G_V = +1$, $R_L = \infty$, $T_a = -40^\circ C$ to $+125^\circ C$	-	-	3.3	mA
Supply Voltage Rejection Ratio	SVR1	$V^+ / V^- = \pm 4.5V$ to $\pm 16V$	86	110	-	dB
	SVR2	$V^+ / V^- = \pm 4.5V$ to $\pm 16V$, $T_a = -40^\circ C$ to $+125^\circ C$	80	-	-	dB

(Note5) Guaranteed by endpoint limits.

●AC CHARACTER ($V^+ / V^- = \pm 15V$, $T_a = 25^\circ C$, $V_{ICM} = 0V$, unless otherwise noted.)

PARAMETER	SYMBOL	TEST CONDITION	MIN.	TYP.	MAX.	UNIT
Dynamic Performance						
Unity Gain Frequency	f_T	$G_V = +100$, $R_L = 2k\Omega$, $C_L = 10pF$	-	7.0	-	MHz
Slew Rate	+SR	RISE, $G_V = +1$, $V_{IN} = 1V_{pp}$, $R_L = 2k\Omega$	-	20	-	V/ μs
	-SR	FALL, $G_V = +1$, $V_{IN} = 1V_{pp}$, $R_L = 2k\Omega$	-	20	-	V/ μs
Total Harmonic Distortion	THD	$f = 1kHz$, $G_V = +1$, $R_L = 2k\Omega$	-	0.0005	-	%
Noise Performance						
Input Voltage Noise	V_{NI}	$f_o = 1Hz$ to $100Hz$	-	0.18	-	μV_{rms}
Input Voltage Noise Density	e_n	$f_o = 1kHz$	-	10	-	nV/ \sqrt{Hz}

New Japan Radio Co., Ltd.

NJM8502

■ ELECTRICAL CHARACTERISTICS

●DC CHARACTER ($V^+/V^- = \pm 5V$, $T_a = 25^\circ C$, $V_{ICM} = 0V$, unless otherwise noted.)

PARAMETER	SYMBOL	TEST CONDITION	MIN.	TYP.	MAX.	UNIT
Input Characteristics						
Input Offset Voltage	V_{IO1}		-	80	400	μV
	V_{IO2}	$T_a = -40^\circ C$ to $+125^\circ C$	-	-	700	μV
Input Offset Voltage Drift (Note5)	$\Delta V_{IO}/\Delta T$	$T_a = -40^\circ C$ to $+125^\circ C$	-	1.0	10	$\mu V/^\circ C$
Input Bias Current	I_{B1}		-	21	75	μA
	I_{B2}	$T_a = -40^\circ C$ to $+125^\circ C$	-	-	31	nA
Input Offset Current	I_{IO1}		-	5	50	μA
	I_{IO2}	$T_a = -40^\circ C$ to $+125^\circ C$	-	-	2	nA
Common Mode Input Voltage Range	V_{ICM1}	$CMR \geq 86dB$	-2.0	-	+2.5	V
	V_{ICM2}	$CMR \geq 80dB$, $T_a = -40^\circ C$ to $+125^\circ C$	-2.0	-	+2.5	V
Common Mode Rejection Ratio	CMR1	$V_{CM} = -2V$ to $+2.5V$	86	108	-	dB
	CMR2	$V_{CM} = -2V$ to $+2.5V$, $T_a = -40^\circ C$ to $+125^\circ C$	80	-	-	dB
Voltage Gain	A_{v1}	$R_L = 2k\Omega$, $V_o = -3V$ to $+3V$	85	93	-	dB
	A_{v2}	$R_L = 2k\Omega$, $V_o = -3V$ to $+3V$, $T_a = -40^\circ C$ to $+125^\circ C$	80	-	-	dB
Channel Separation	CS	DC	-	125	-	dB
Output Characteristics						
Maximum Output Voltage	V_{OH1}	$R_L = 10k\Omega$, $T_a = -40^\circ C$ to $+125^\circ C$	+4.1	+4.3	-	V
	V_{OL1}	$R_L = 10k\Omega$, $T_a = -40^\circ C$ to $+125^\circ C$	-	-4.9	-4.7	V
	V_{OH2}	$R_L = 2k\Omega$, $T_a = -40^\circ C$ to $+125^\circ C$	+3.9	+4.2	-	V
	V_{OL2}	$R_L = 2k\Omega$, $T_a = -40^\circ C$ to $+125^\circ C$	-	-4.9	-4.5	V
	V_{OH31}	$R_L = 600\Omega$	+3.7	+4.1	-	V
	V_{OH32}	$R_L = 600\Omega$, $T_a = -40^\circ C$ to $+125^\circ C$	+3.6	-	-	V
	V_{OL41}	$R_L = 600\Omega$	-	-4.8	-4.3	V
	V_{OL42}	$R_L = 600\Omega$, $T_a = -40^\circ C$ to $+125^\circ C$	-	-	-4.2	V
Supply Characteristics						
Quiescent Current	I_{CC1}	$G_V = +1$, $R_L = \infty$	-	2.0	3.0	mA
	I_{CC2}	$G_V = +1$, $R_L = \infty$, $T_a = -40^\circ C$ to $+125^\circ C$	-	-	3.3	mA

(Note5) Guaranteed by endpoint limits.

●AC CHARACTER ($V^+/V^- = \pm 5V$, $T_a = 25^\circ C$, $V_{ICM} = 0V$, unless otherwise noted.)

PARAMETER	SYMBOL	TEST CONDITION	MIN.	TYP.	MAX.	UNIT
Dynamic Performance						
Unity Gain Frequency	f_T	$G_V = +100$, $R_L = 2k\Omega$, $C_L = 10pF$	-	7.0	-	MHz
Slew Rate	+SR	RISE, $G_V = +1$, $V_{IN} = 1V_{pp}$, $R_L = 2k\Omega$	-	18	-	$V/\mu s$
	-SR	FALL, $G_V = +1$, $V_{IN} = 1V_{pp}$, $R_L = 2k\Omega$	-	18	-	$V/\mu s$
Total Harmonic Distortion	THD	$f = 1kHz$, $G_V = +1$, $R_L = 2k\Omega$	-	0.0005	-	%
Noise Performance						
Input Voltage Noise	V_{NI}	$f_o = 1Hz$ to $100Hz$	-	0.18	-	μV_{rms}
Input Voltage Noise Density	e_n	$f_o = 1kHz$	-	10	-	nV/\sqrt{Hz}

■ TEST CIRCUIT

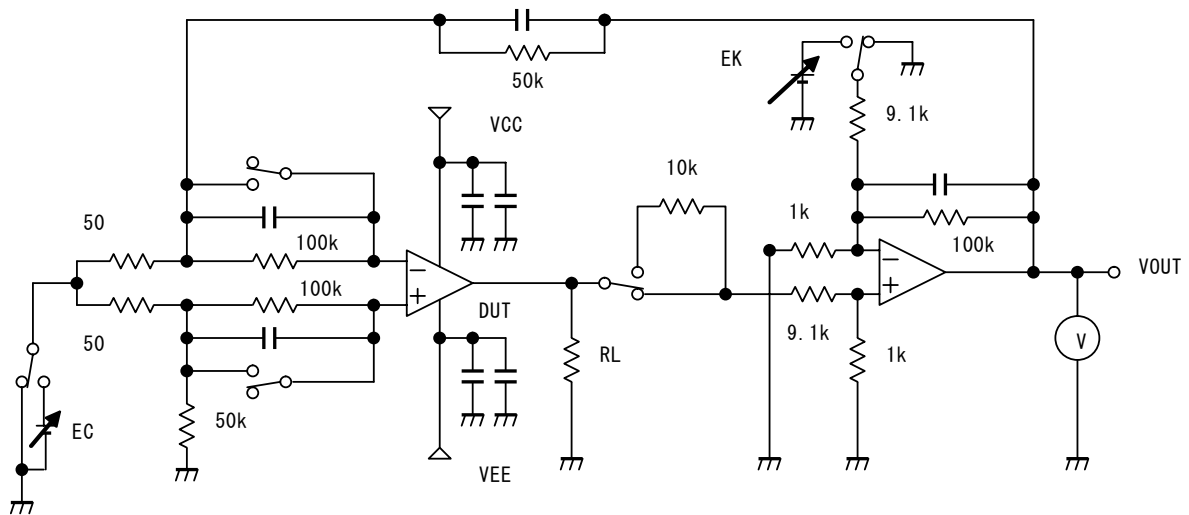

Fig.1 test circuit for Input Offset Voltage, Input Offset Current, Input Bias Current, Voltage Gain, Supply Voltage Rejection Ratio, Common Mode Rejection Ratio

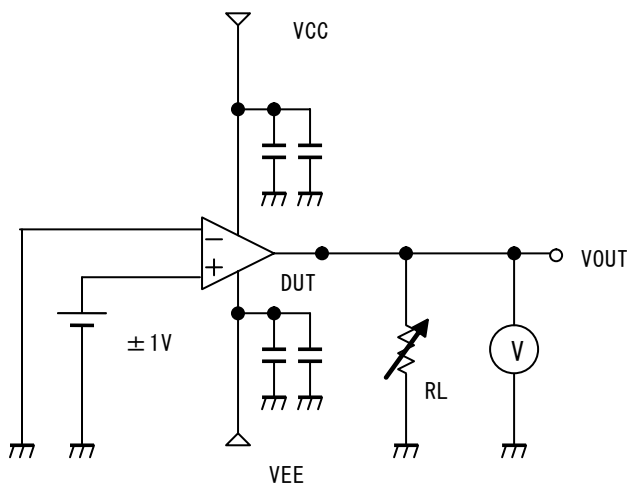

Fig.2 test circuit for Maximum Output Voltage

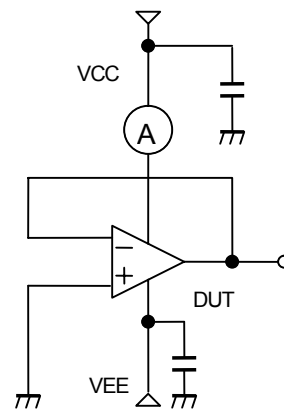
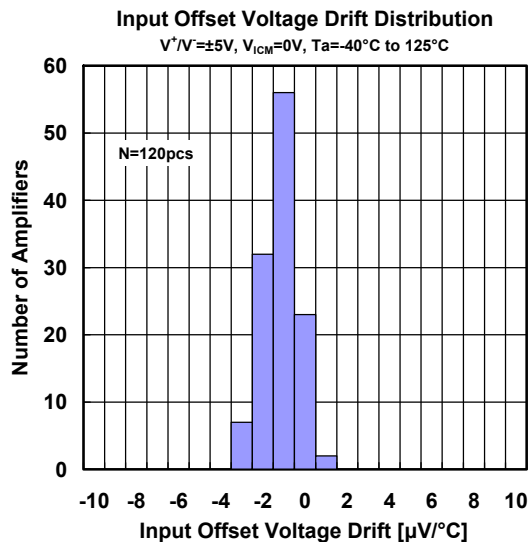
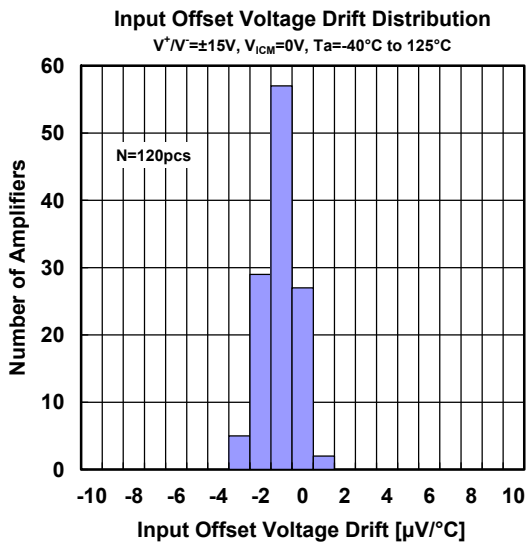
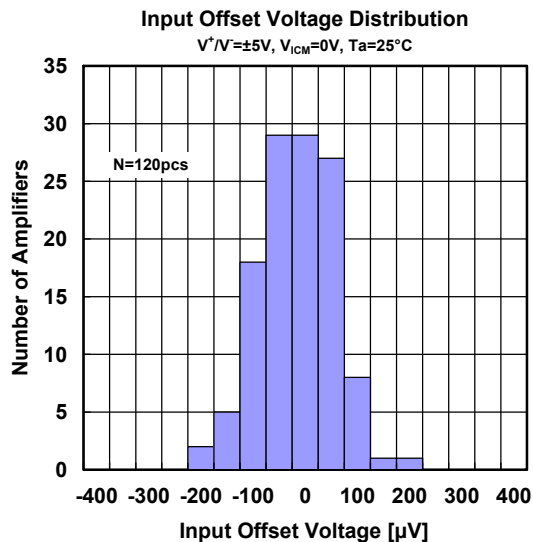
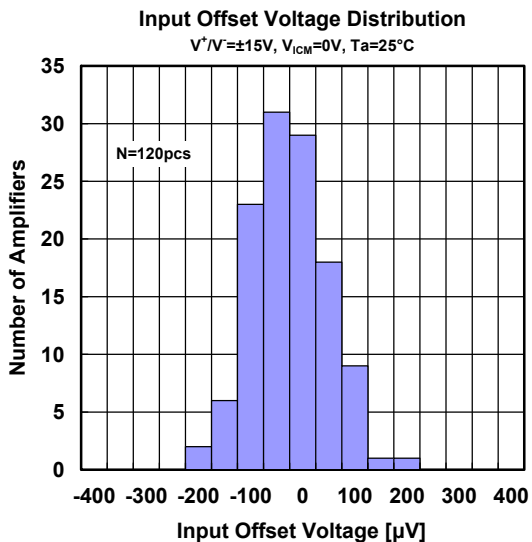
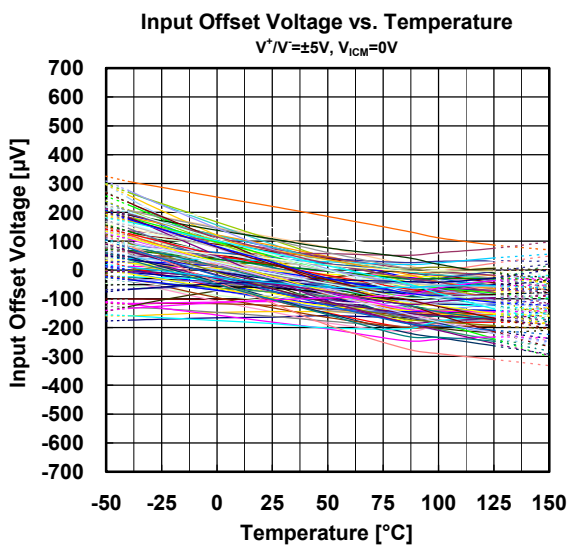
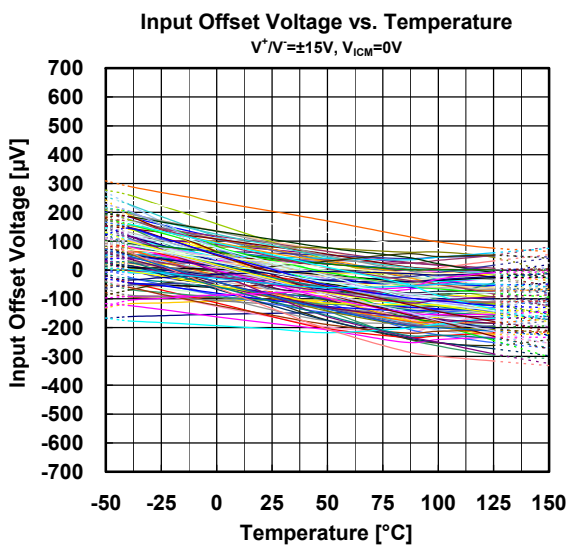
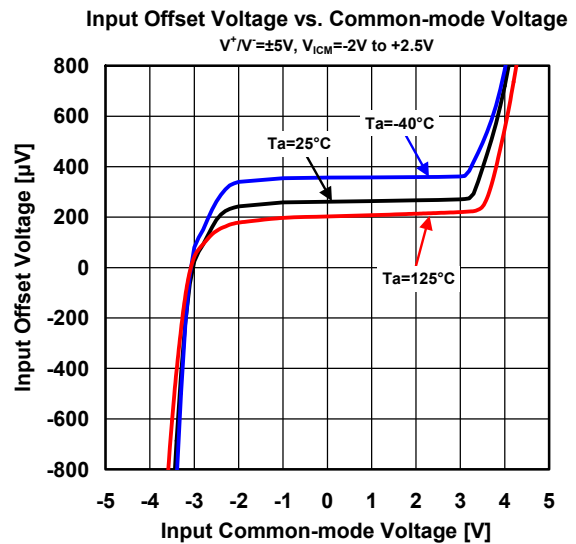
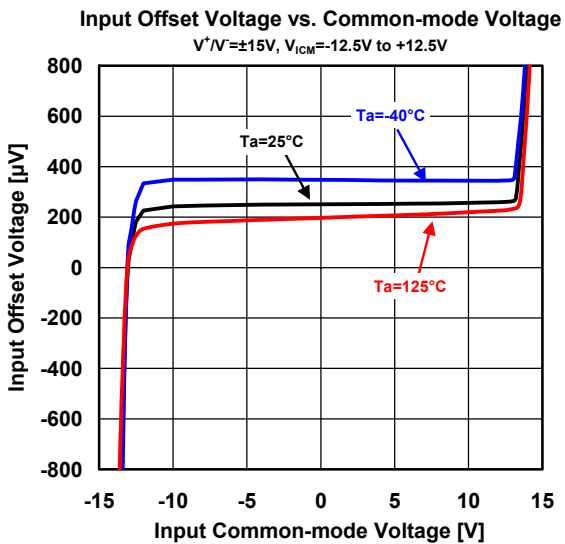
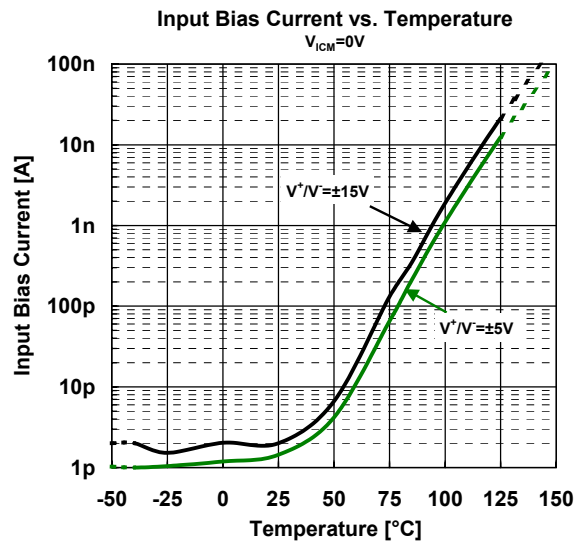
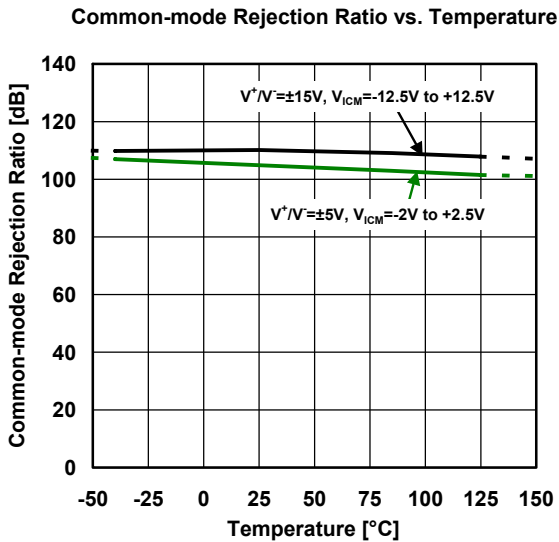
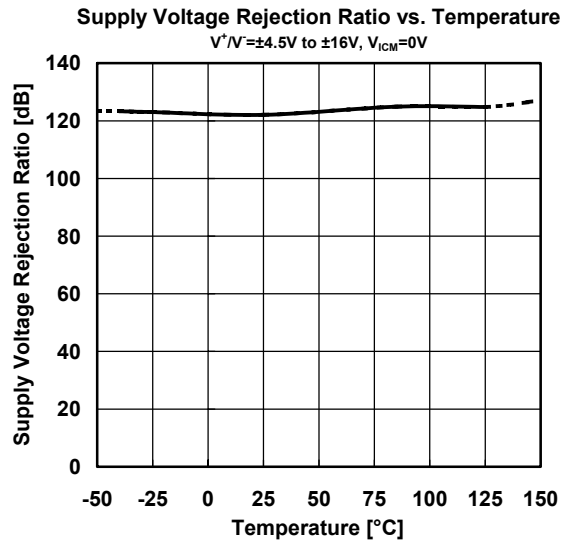
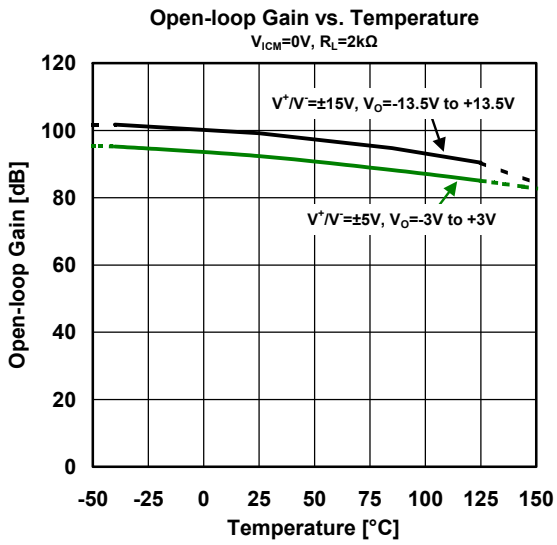

Fig.3 test circuit for Quiescent Current

ELECTRICAL CHARACTERISTICS





Maximum Output Voltage vs. Load Resistance

$V^*/V = \pm 15V, V_{IN+} = 1V/-1V, V_{IN} = 0V$

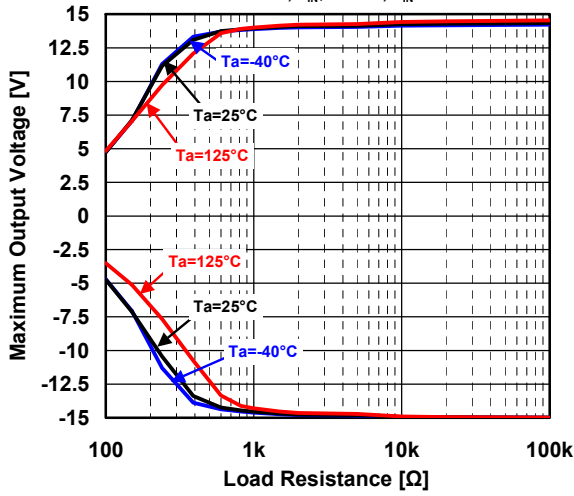

Maximum Output Voltage vs. Load Resistance

$V^*/V = \pm 5V, V_{IN+} = 1V/-1V, V_{IN} = 0V$

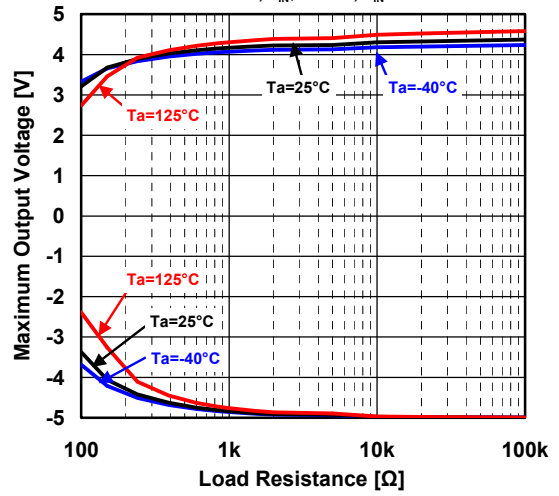

Maximum Output Voltage vs. Temperature

$V^*/V = \pm 15V, V_{IN+} = 1V/-1V, V_{IN} = 0V$

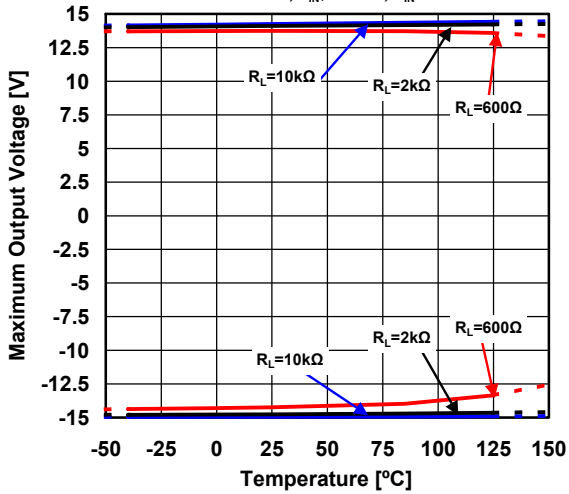

Maximum Output Voltage vs. Temperature

$V^*/V = \pm 5V, V_{IN+} = 1V/-1V, V_{IN} = 0V$

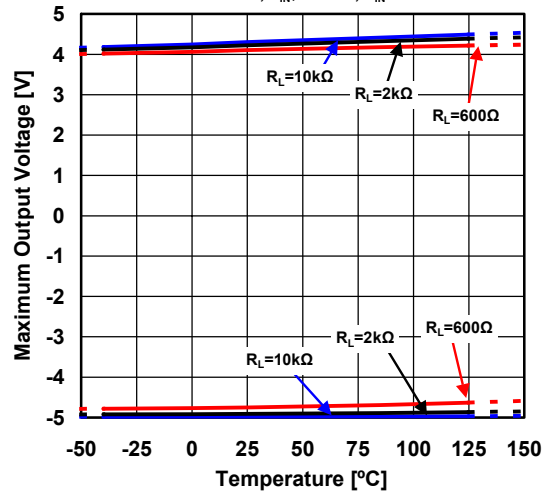

Short Circuit Output Current

$V^*/V = \pm 15V, V_{IN+} = 0V, V_O = 0V, Ta = 25^\circ C$

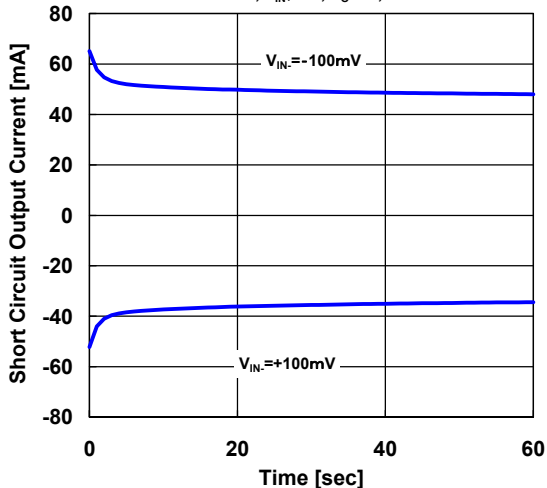

Quiescent Current vs. Supply Voltage

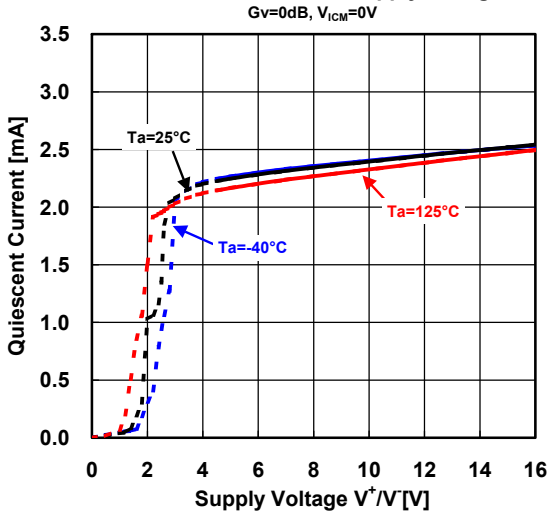

Quiescent Current vs. Temperature

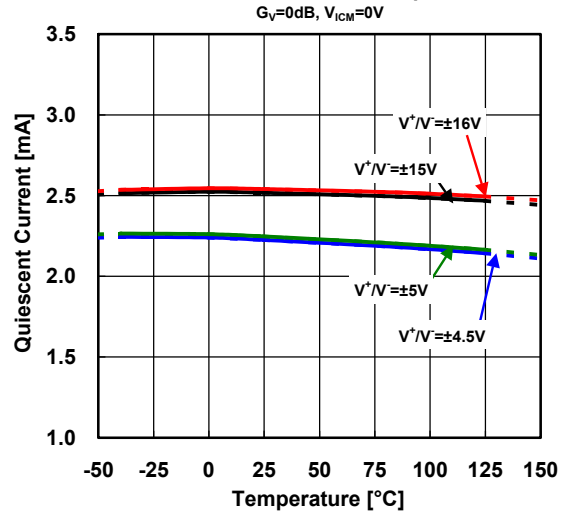

Gain/Phase vs. Frequency

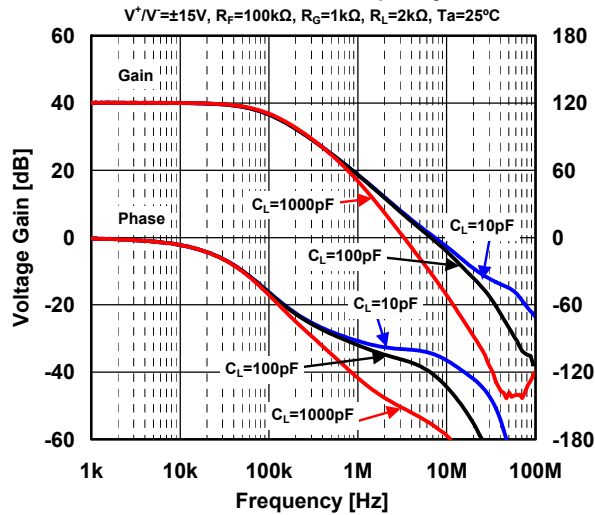

Gain/Phase vs. Frequency

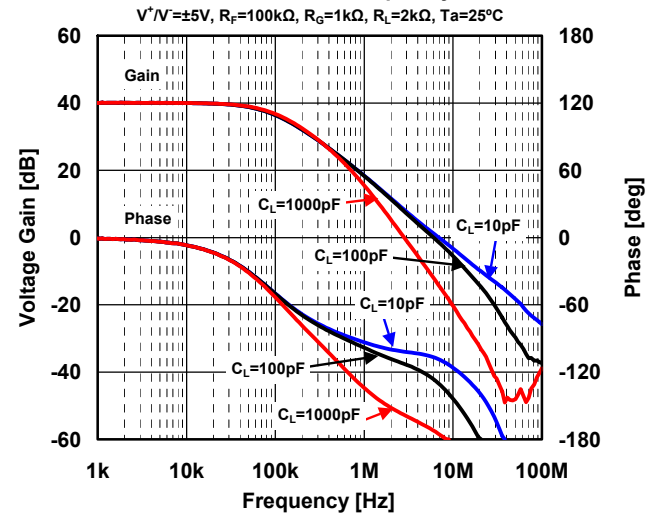

Small-Signal Step Response (Load Capacitance)

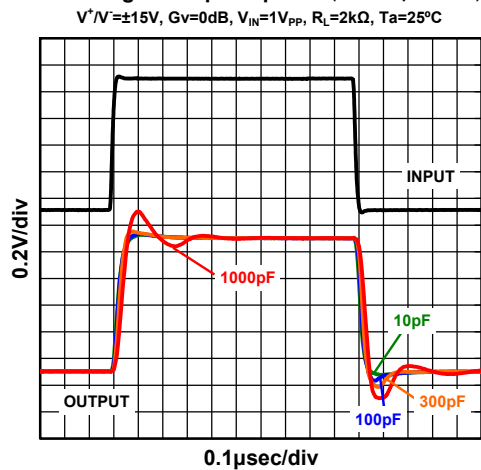

Small-Signal Step Response (Temperature)

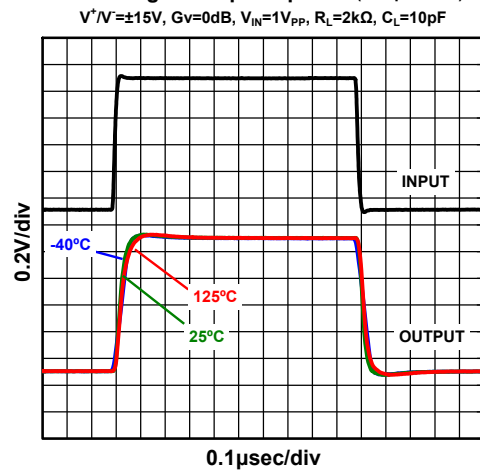

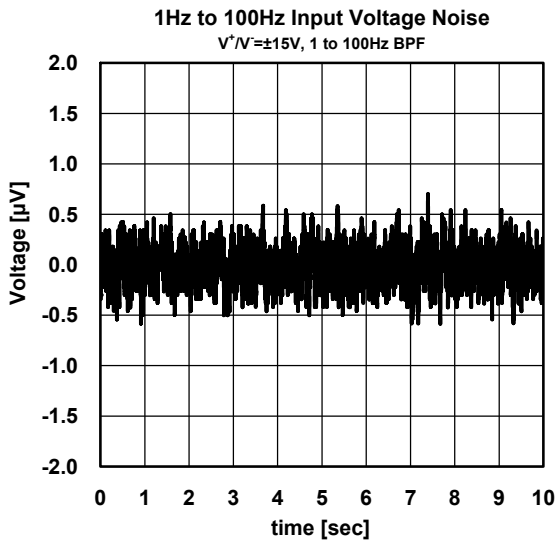
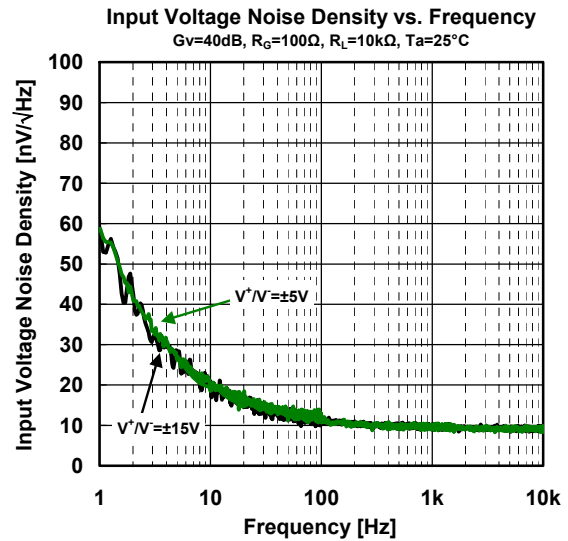
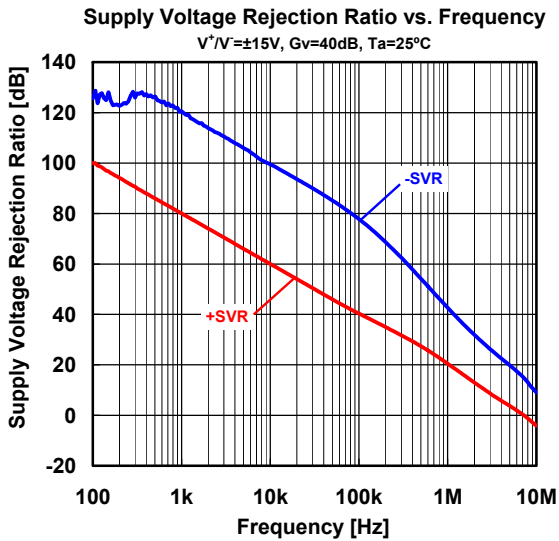
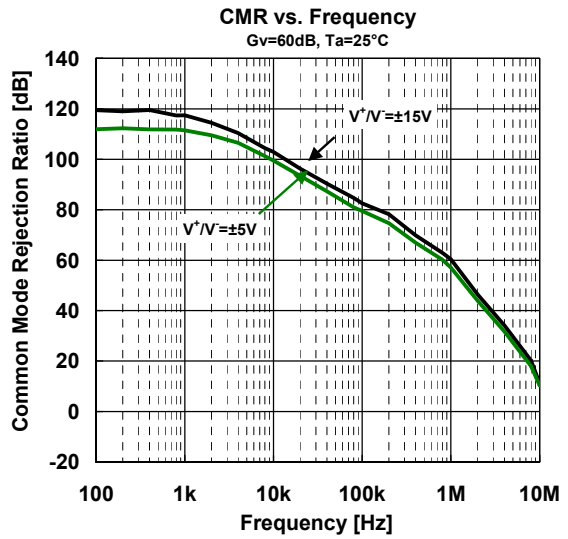
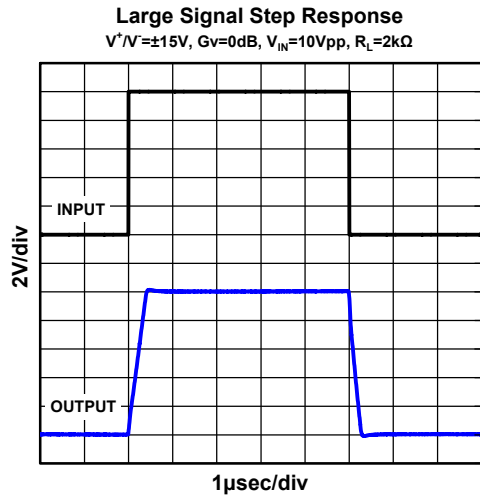

[CAUTION]
 The specifications on this databook are only given for information, without any guarantee as regards either mistakes or omissions. The application circuits in this databook are described only to show representative usages of the product and not intended for the guarantee or permission of any right including the industrial rights.