

SINGLE-SUPPLY DUAL HIGH CURRENT OPERATIONAL AMPLIFIER

■ GENERAL DESCRIPTION

The NJM3414A integrated circuit is a high gain, high output current, high output voltage swing dual operational amplifier capable of driving 70mA.

■ FEATURES

- Single Supply
- Operating Voltage (+3V~+15V)
- High Output Current (70mA typ.)
- Slew Rate (1.0V/μs typ.)
- Package Outline DIP8,DMP8,SIP8,SSOP8
- Bipolar Technology

■ PACKAGE OUTLINE

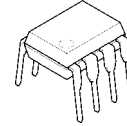

NJM3414AD



NJM3414AM



NJM3414AL



NJM3414AV

■ PIN CONFIGURATION

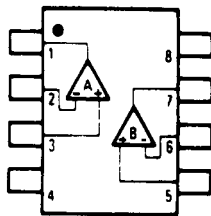

NJM3414AD
NJM3414AM
NJM3414AV

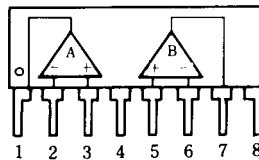

NJM3414AL

PIN FUNCTION

- 1.A OUTPUT
- 2.A -INPUT
- 3.A +INPUT
- 4.V⁻
- 5.B +INPUT
- 6.B -INPUT
- 7.B OUTPUT
- 8.V⁺

■ EQUIVALENT CIRCUIT (1/2 Shown)

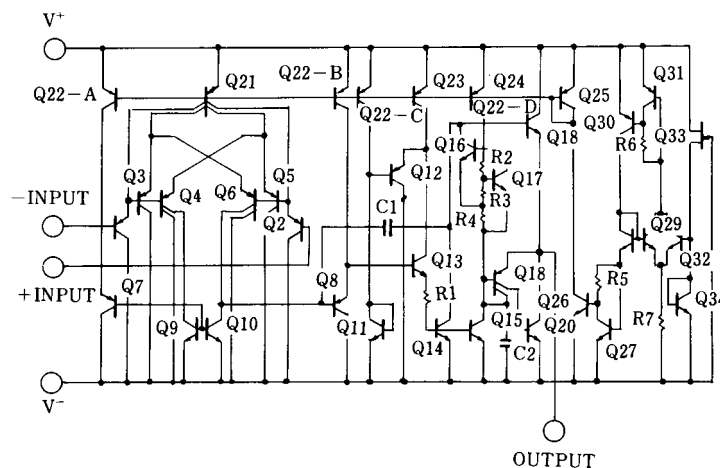

■ ABSOLUTE MAXIMUM RATINGS

(Ta=25°C)

PARAMETER	SYMBOL	RATINGS	UNIT
Supply Voltage	$V^+(V^-/V)$	15V (or ± 7.5)	V
Differential Input Voltage	V_{ID}	15	V
Input Voltage	V_{IC}	-0.3~+15	V
Power Dissipation	P_D	(DIP8) 500 (DMP8) 300 (SSOP8) 250 (SIP8) 800	mW
Operating Temperature Range	T_{opr}	-40~+85	°C
Storage Temperature Range	T_{stg}	-40~+125	°C

■ ELECTRICAL CHARACTERISTICS

(Ta=25°C, $V^+=8.6V$)

PARAMETER	SYMBOL	TEST CONDITION	MIN.	TYP.	MAX.	UNIT
Input Offset Voltage	V_{IO}	$R_S=0\Omega$	-	2	5	mV
Input Offset Current	I_{IO}		-	5	100	nA
Input Bias Current	I_B		-	100	500	nA
Large Signal Voltage Gain	A_v	$R_L=2k\Omega$	88	100	-	dB
Input Common Voltage Range	V_{ICM}		V^+-2	-	-	V
Maximum Output Voltage Swing 1	V_{OM1}	$R_L \geq 2k\Omega, V^+=5V$	3.5	-	-	V
Maximum Output Voltage Swing 2	V_{OM2}	$I_O=70mA, V^+=5V$	3.2	-	-	V
Common Mode Rejection Ratio	CMR		80	90	-	dB
Supply Voltage Rejection Ratio	SVR		80	90	-	dB
Operating Current	I_{CC}	$R_L=\infty$	3	4	5	mA
Slew Rate	SR		-	1.0	-	V/ μs
Gain Bandwidth Product	GB		-	1.3	-	MHz
Operating Voltage Range	V^+		-	-	15	V

■ TYPICAL CHARACTERISTICS

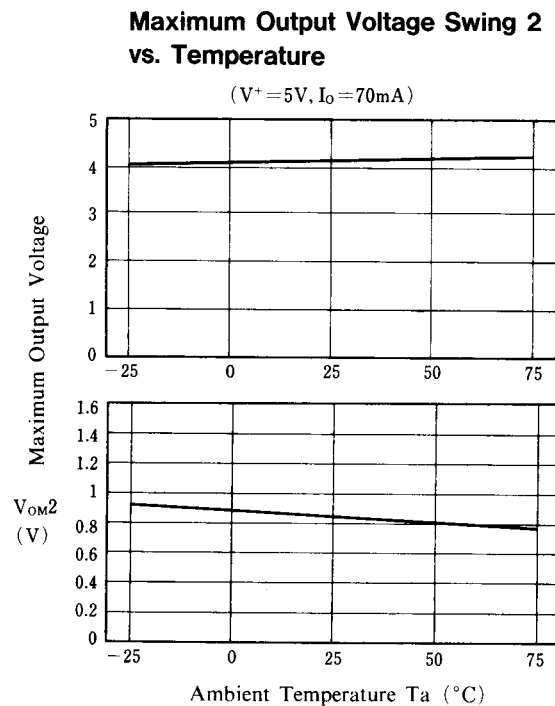
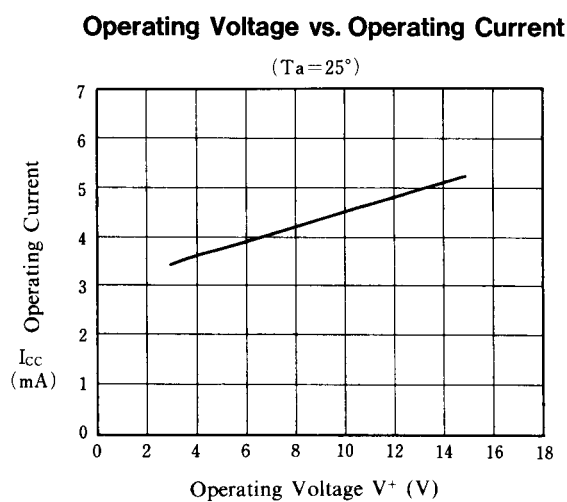
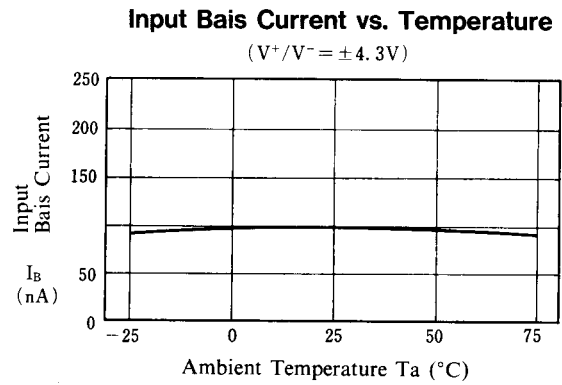
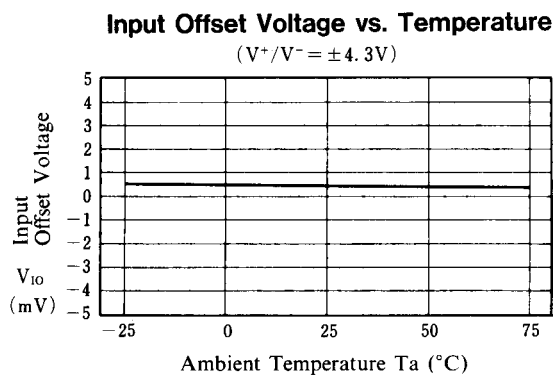
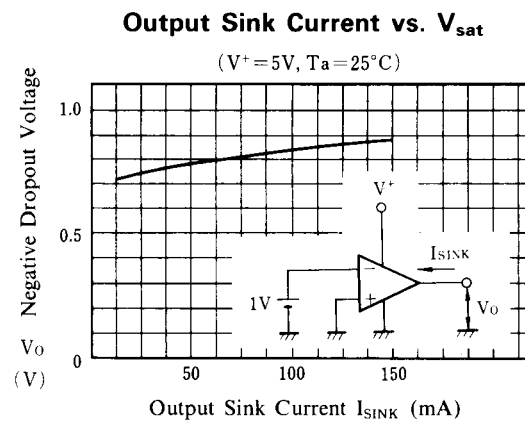
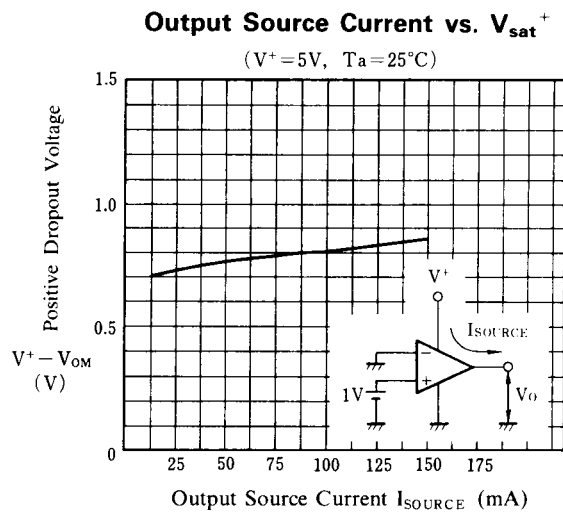

■ TYPICAL CHARACTERISTICS

Maximum Output Voltage vs. Operating Voltage

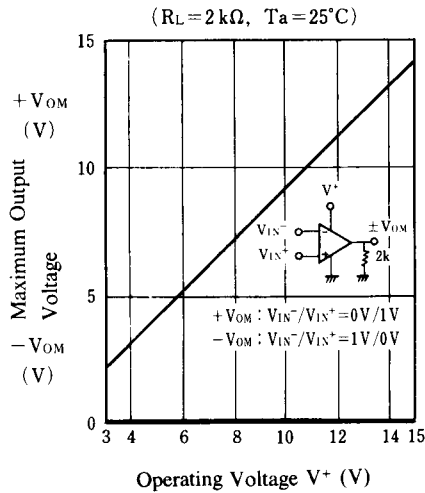

Maximum Output Voltage vs. Load Resistance

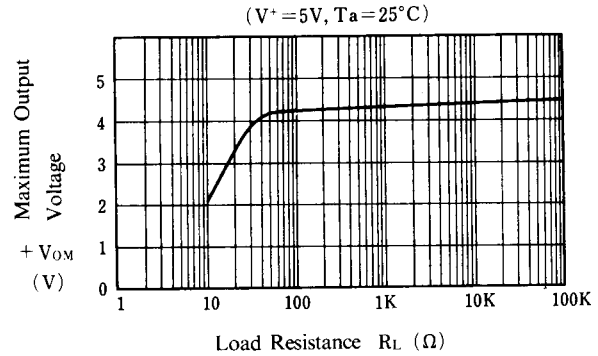

Maximum Output Voltage vs. Frequency

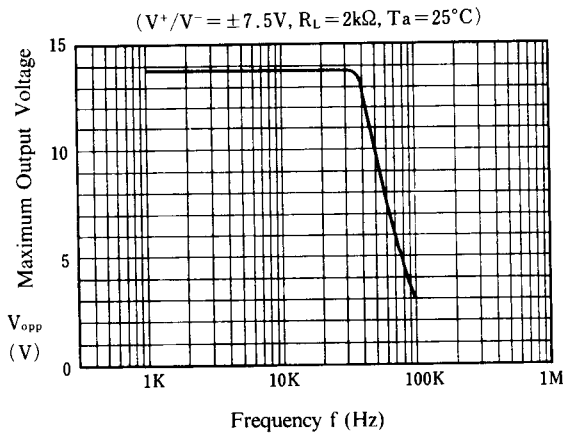

Voltage Gain, Phase vs. Frequency

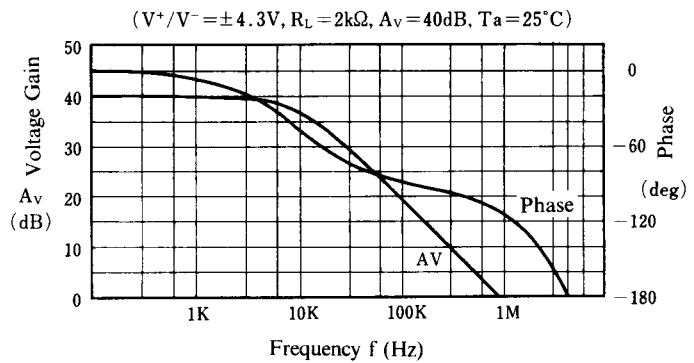

Operating Current vs. Temperature

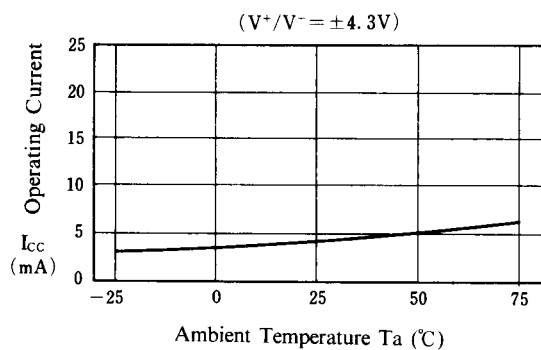

Maximum Output Voltage vs. Temperature

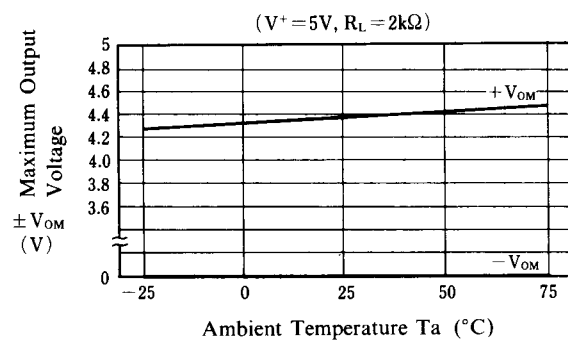

[CAUTION]

The specifications on this databook are only given for information, without any guarantee as regards either mistakes or omissions. The application circuits in this databook are described only to show representative usages of the product and not intended for the guarantee or permission of any right including the industrial rights.