

■ OUTPUT VOLTAGE RANK LIST

Device Name	V _{OUT}
NJM287×F21	2.1V
NJM287×F28	2.8V
NJM287×F03	3.0V
NJM287×F33	3.3V
NJM287×F05	5.0V

■ ABSOLUTE MAXIMUM RATINGS (Ta=25°C)

PARAMETER	SYMBOL	RATINGS	UNIT	
Input Voltage	V _{IN}	+14	V	
Control Voltage	V _{CONT}	+14(*1)	V	
Power Dissipation	P _D	SOT-23-5	350(*2)	mW
			200(*3)	
Operating Temperature	Topr	-40 ~ +85	°C	
Storage Temperature	Tstg	-40 ~ +125	°C	

(*1):When input voltage is less than +14V, the absolute maximum control voltage is equal to the input voltage.

(*2):Mounted on glass epoxy board. (114.3x76.2x1.6mm: 2Layer, FR-4)

(*3):Device itself

■ ELECTRICAL CHARACTERISTICS

(V_{IN}=V_o+1V, C_{IN}=0.1μF, C_o=1.0μF: V_o≥2.7V (C_o=2.2μF: V_o≤2.6V), Ta=25°C)

PARAMETER	SYMBOL	TEST CONDITION	MIN.	TYP.	MAX.	UNIT
Output Voltage	V _o	I _o =30mA	-1.0%	—	+1.0%	V
Quiescent Current	I _Q	I _o =0mA, expect I _{cont}	—	120	180	μA
Quiescent Current at Control OFF	I _{Q(OFF)}	V _{CONT} =0V	—	—	100	nA
Output Current	I _o	V _o -0.3V	150	200	-	mA
Line Regulation	ΔV _o /ΔV _{IN}	V _{IN} =V _o +1V ~ V _o +6V, I _o =30mA	—	—	0.10	%/V
Load Regulation	ΔV _o /ΔI _o	I _o =0 ~ 100mA	—	—	0.03	%/mA
Dropout Voltage	ΔV _{L-O}	I _o =60mA	—	0.10	0.18	V
Ripple Rejection	RR	e _{in} =200mVrms, f=1kHz, I _o =10mA, V _o =3V Version	—	75	—	dB
Average Temperature Coefficient of Output Voltage	ΔV _o /ΔTa	Ta=0 ~ 85°C, I _o =10mA	—	±50	—	ppm/°C
Output Noise Voltage	V _{NO}	f=10Hz ~ 80kHz, I _o =10mA, V _o =3V Version	—	45	—	μVrms
Control Voltage for ON-state	V _{CONT(ON)}		1.6	—	—	V
Control Voltage for OFF-state	V _{CONT(OFF)}		—	—	0.6	V

The above specification is a common specification for all output voltages.

Therefore, it may be different from the individual specification for a specific output voltage.

■ TEST CIRCUIT

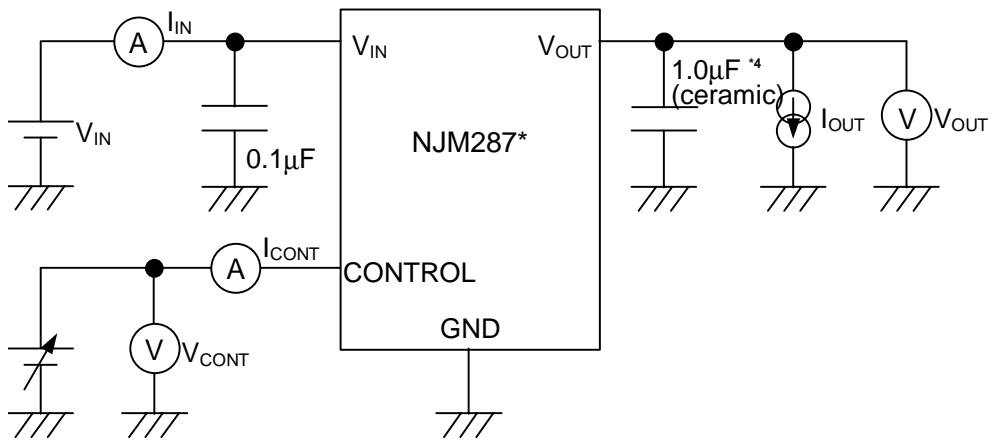

*4 $V_o \leq 2.6V$ version: $C_o = 2.2\mu F$ (ceramic)

■ TYPICAL APPLICATION

① In case that ON/OFF Control is not required:

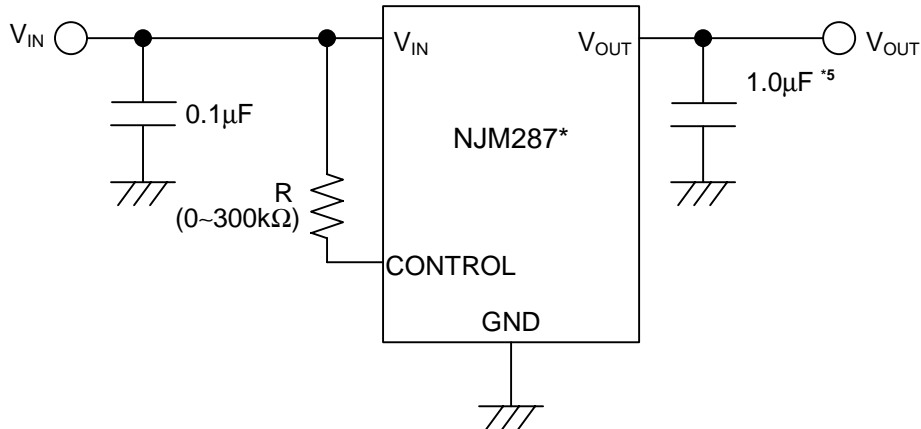

*5 $V_o \leq 2.6V$ version: $C_o = 2.2\mu F$

Connect control terminal to V_{IN} terminal

② In use of ON/OFF CONTROL:

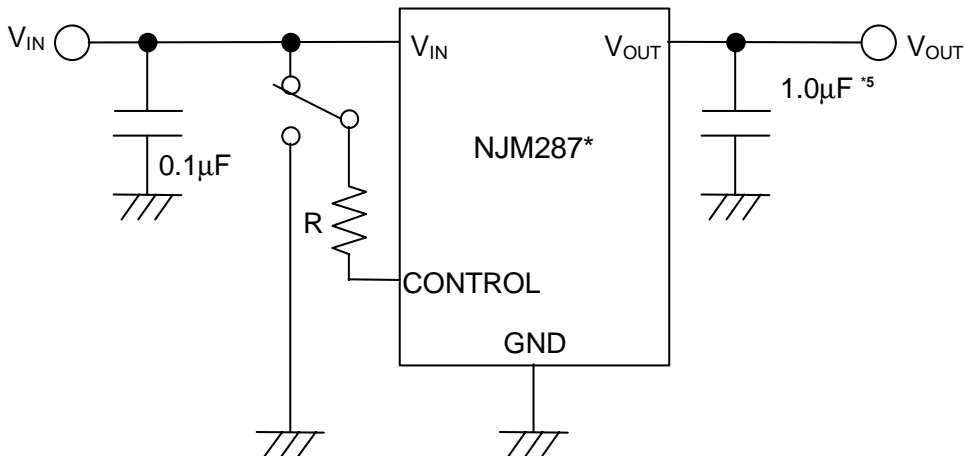

*5 $V_o \leq 2.6V$ version: $C_o = 2.2\mu F$

State of control terminal:

- "H" → output is enabled.
- "L" or "open" → output is disabled.

*Noise bypass Capacitance C_p

Noise bypass capacitance C_p reduces noise generated by band-gap reference circuit. Noise level and ripple rejection will be improved when larger C_p is used. Use of smaller C_p value may cause oscillation. Use the C_p value of $0.01\mu F$ greater to avoid the problem.

*In the case of using a resistance "R" between V_{IN} and control.

The current flow into the control terminal while the IC is ON state (I_{CONT}) can be reduced when a pull up resistance "R" is inserted between V_{IN} and the control terminal. The minimum control voltage for ON state ($V_{CONT(ON)}$) is increased due to the voltage drop caused by I_{CONT} and the resistance "R". The I_{CONT} is temperature dependence as shown in the "Control Current vs. Temperature" characteristics. Therefore, the resistance "R" should be carefully selected to ensure the control voltage exceeds the $V_{CONT(ON)}$ over the required temperature range.

POWER DISSIPATION vs. AMBIENT TEMPERATURE

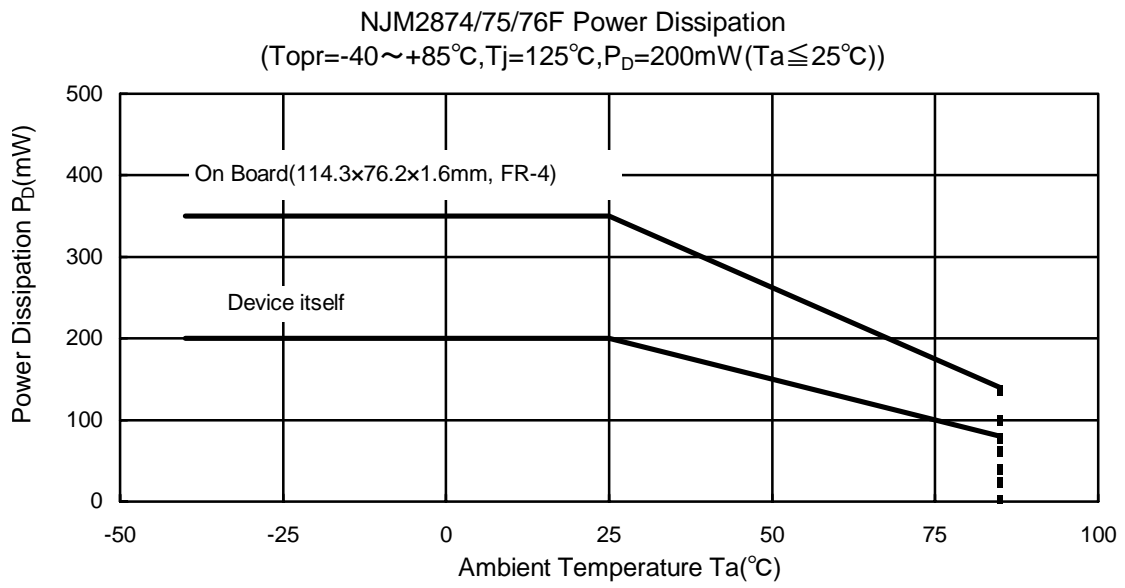

■ ELECTRICAL CHARACTERISTICS

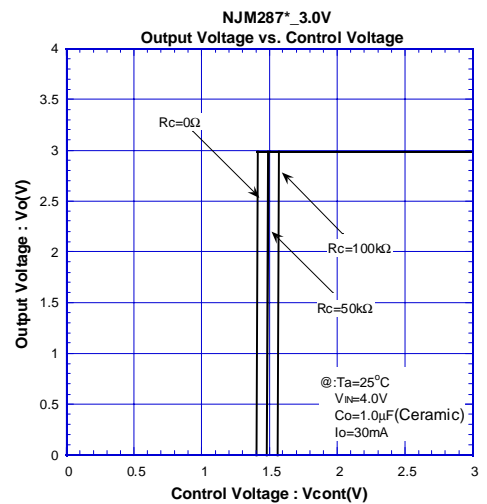
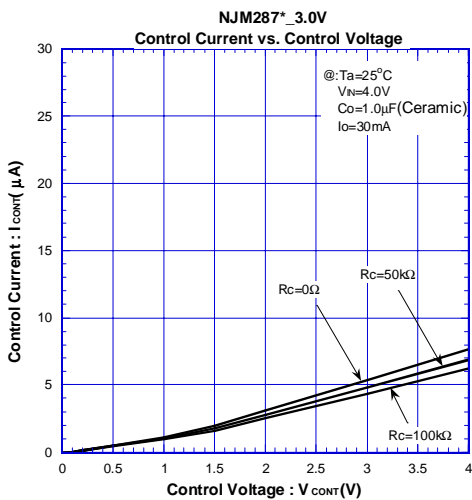
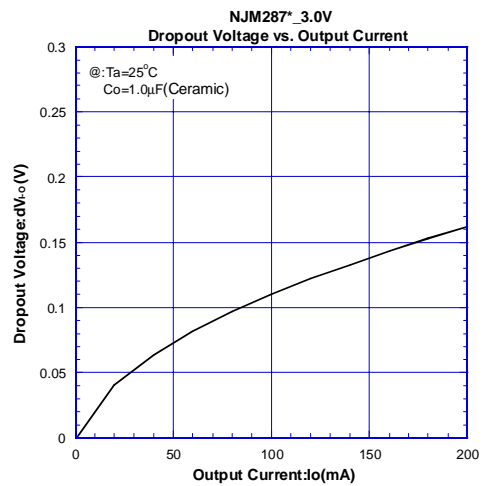
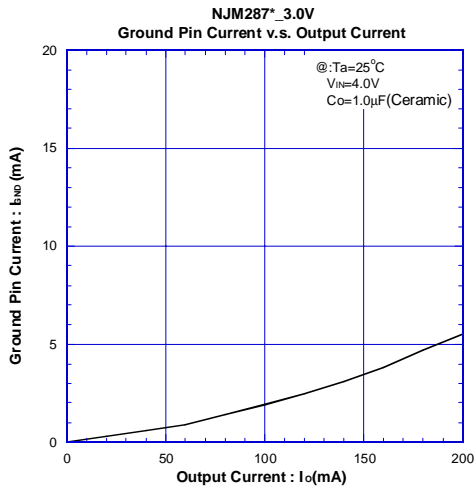
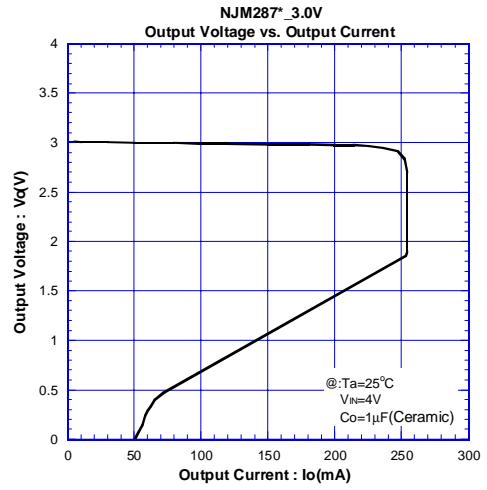
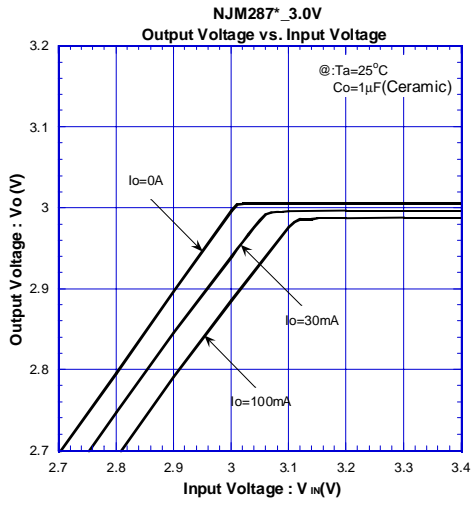

■ ELECTRICAL CHARACTERISTICS

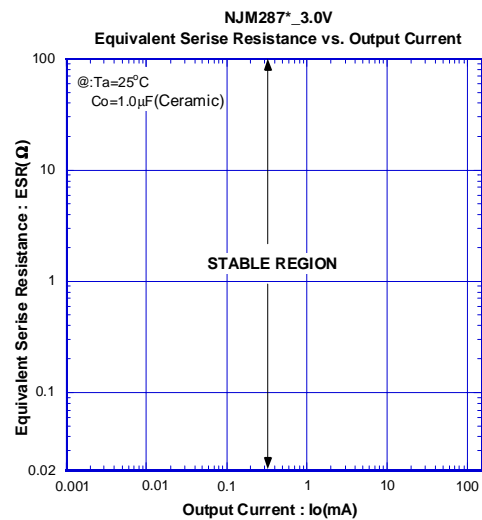
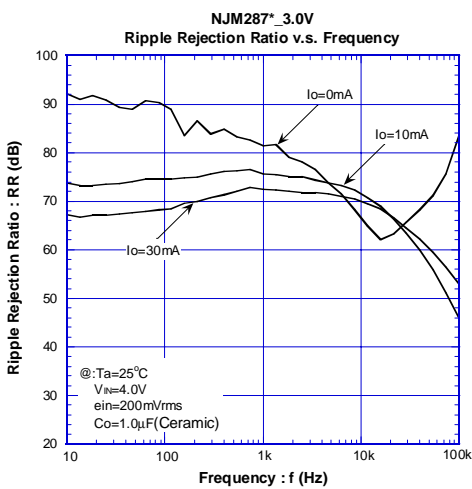
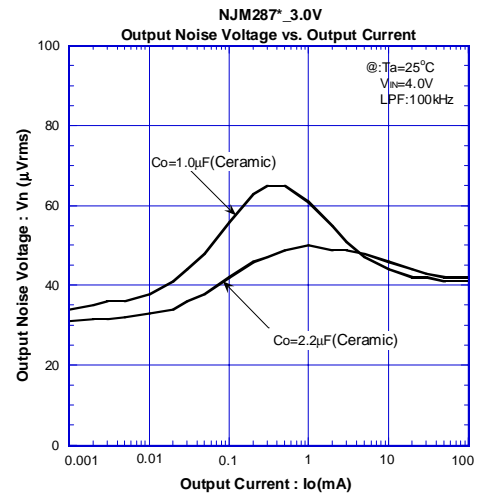
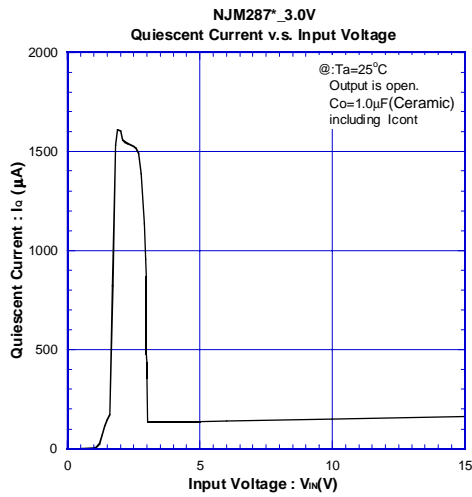
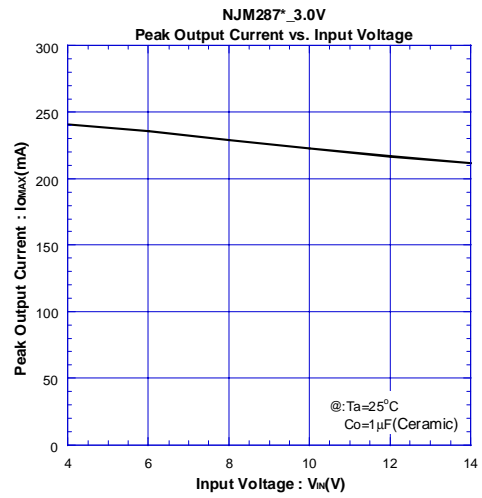
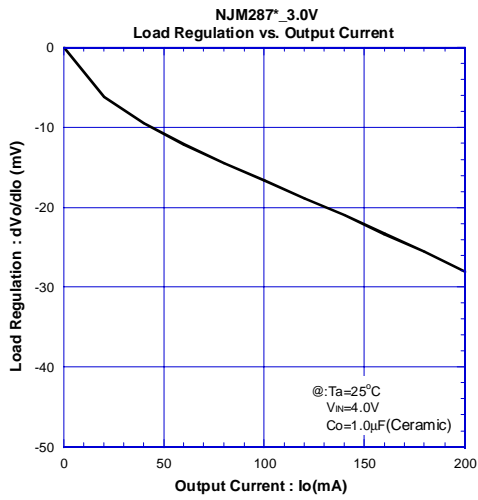

ELECTRICAL CHARACTERISTICS

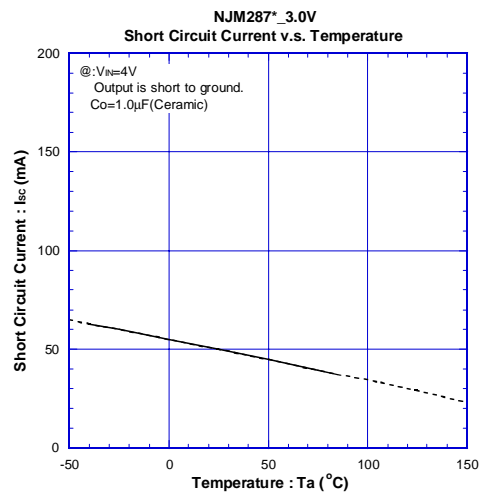
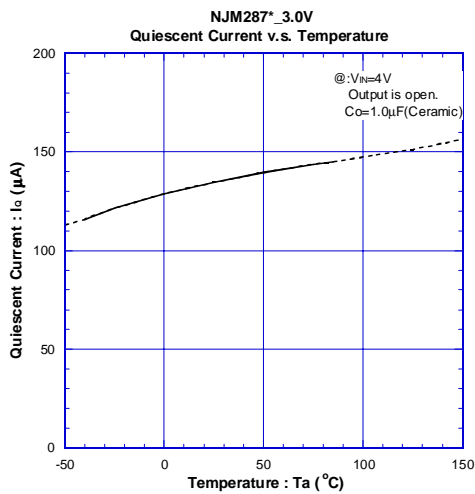
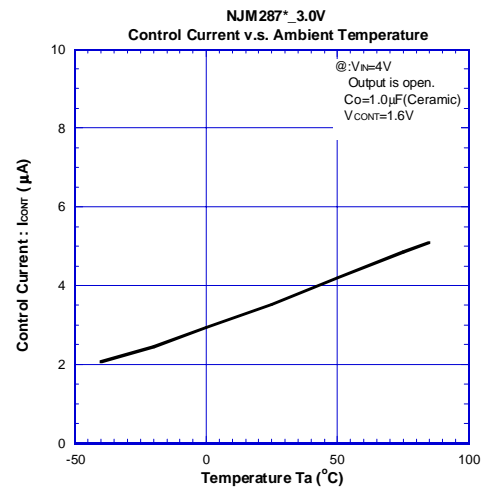
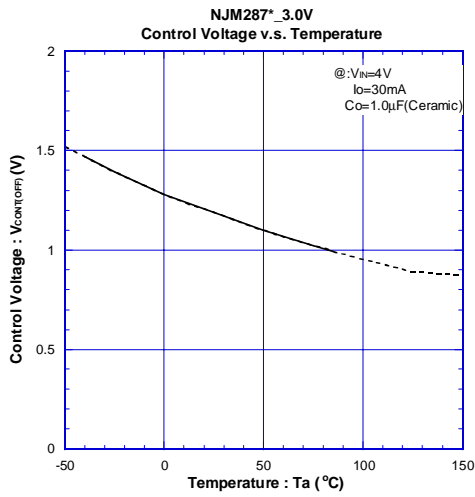
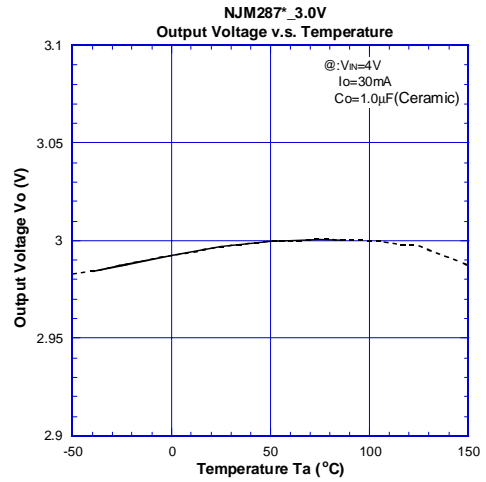
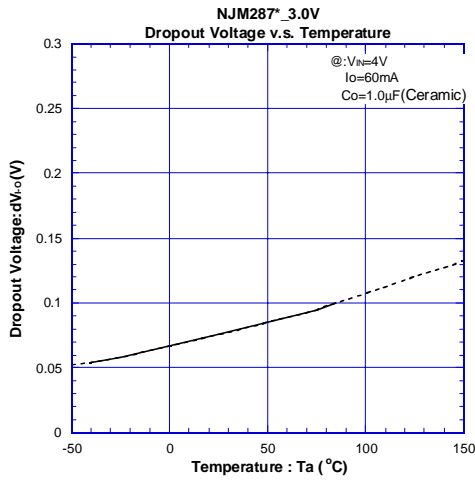

■ ELECTRICAL CHARACTERISTICS

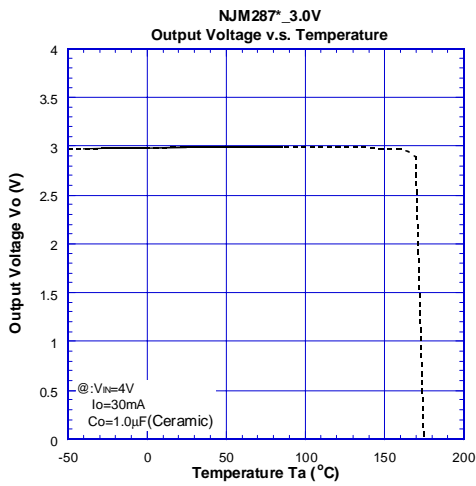
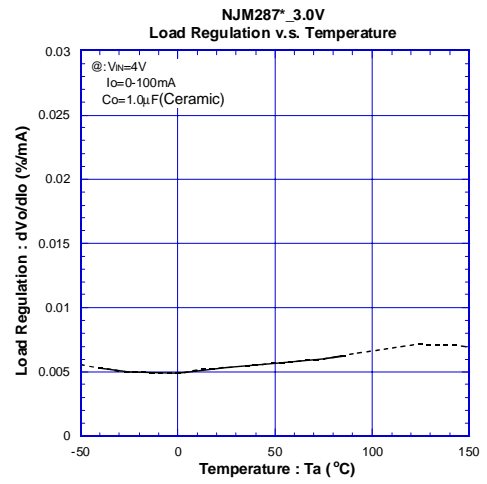
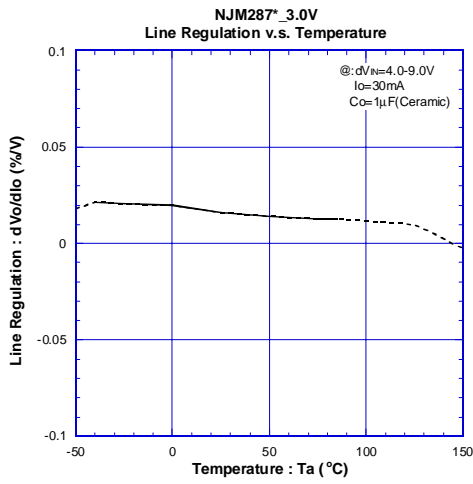

■ ELECTRICAL CHARACTERISTICS

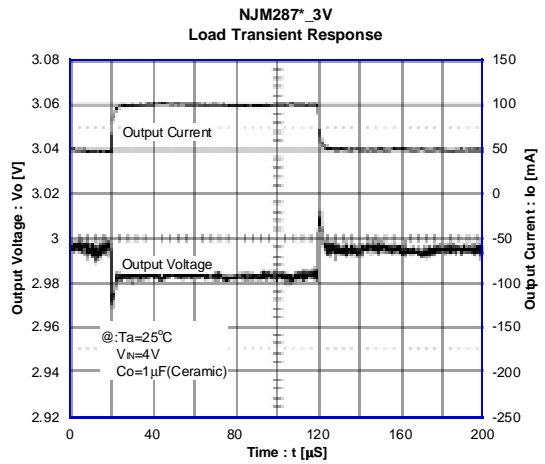
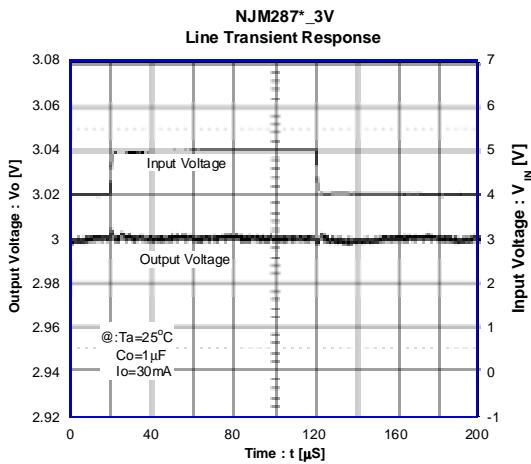
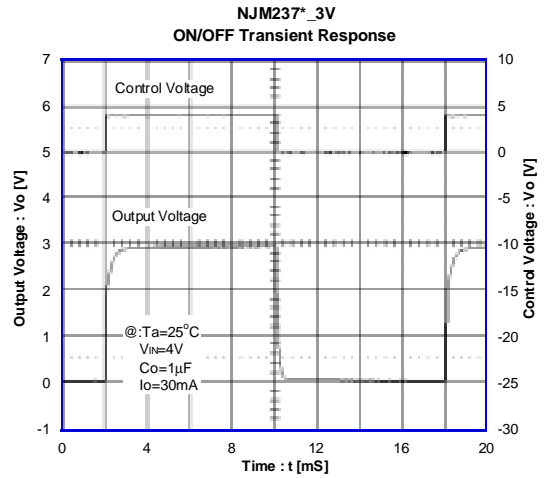
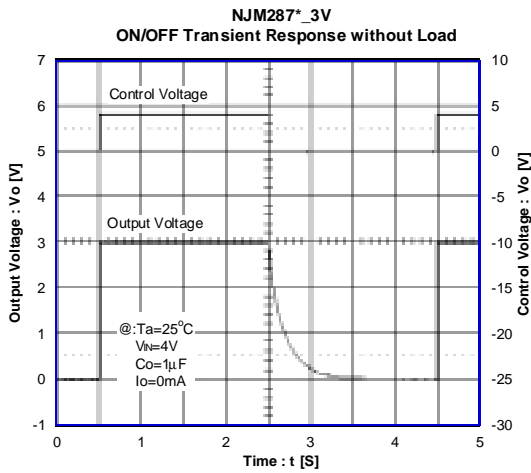

[CAUTION]

The specifications on this databook are only given for information, without any guarantee as regards either mistakes or omissions. The application circuits in this databook are described only to show representative usages of the product and not intended for the guarantee or permission of any right including the industrial rights.