

Precision Operational Amplifier

■ FEATURES

- Precision $V_{IO}=60\mu\text{V max.}$
 $V_{IO}=100\mu\text{V max. (Ta=-40°C to +85°C)}$
- Low Offset Drift $\Delta V_{IO}/\Delta T=0.9\mu\text{V/°C max. (Ta=-40 to +85°C)}$
- Specified for $\pm 15\text{V}$ and $\pm 5\text{V}$ operation
- CMR 130dB min.
- Low Noise $V_{NI}=80\text{nVrms typ. at f=1 to 100Hz}$
 $e_n=8\text{nV}/\sqrt{\text{Hz typ. at f=100Hz}}$
- Open Loop Gain $A_v=130\text{dB min.}$
- Guaranteed Temperature $T_a=-40^\circ\text{C to }+85^\circ\text{C}$
- Unity Gain Stable
- Operating Voltage $V_{opr}=\pm 3\text{V to } \pm 18\text{V}$
- Unity Gain Frequency $f_T=1.1\text{MHz typ.}$
- Supply Current $I_{cc}=2\text{mA max.}$
- Package SOP8 JEDEC 150mil

■ PACKAGE OUTLINE

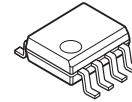

NJM2729E
(SOP8)

■ GENERAL DESCRIPTION

The NJM2729 is a high performance operational amplifier features very low offset voltage and drift.

Features are low offset voltage and drift, hi common mode rejection, low noise and open loop gain. DC characteristics are 100% tested and specified from -40 to 85°C .

The NJM2729 is suitable for high gain circuit amplified small signal and sets required stable behavior over a wide temperature range.

■ APPRICATION

- Thermocouple sensor
- Bridge Amplifier
- Current Sensor
- Instrumentation Amplifier
- Reference Voltage Circuit

■ PIN CONFIGURATION

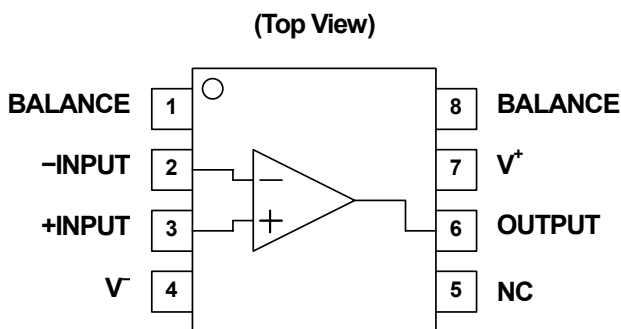

■ PACKAGE DESCRIPTION

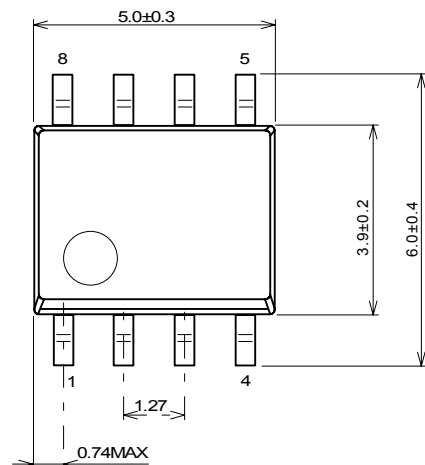

SOP8 MEET JEDEC MS-012-AA

NJM2729

■ ABSOLUTE MAXIMUM RATING

(Ta=25°C Unless Otherwise Specified)

PARAMETER	SYMBOL	RATING	UNIT
Supply Voltage	V ⁺ /V	±20	V
Common Mode Input Voltage (Note1)	V _{ICM}	±20	V
Differential Input Voltage	V _{ID}	±30	V
Power Dissipation (Note 2)	P _D	640	mW
Operating Temperature	Topr	-40 to +85	°C
Storage Temperature	Tstg	-50 to +125	°C

(Note1) For supply voltage less than ±20V, the maximum input voltage is equal to the supply voltage.

(Note2) Mounted on the EIA/JEDEC standard board (76.2×114.3×1.6mm, two layer, FR-4).

■ RECOMMENDED OPERATING VOLTAGE

PARAMETER	SYMBOL	TEST CONDITION	MIN.	TYP.	MAX.	UNIT
Supply Voltage	V ⁺ /V		±3	-	±18	V

■ ELECTRONIC CHARACTERISTICS

(V⁺/V=±15V Ta=+25°C, V_{ICM}=0V unless otherwise specified)

● DC CHARACTERISTICS

PARAMETER	SYMBOL	TEST CONDITION	MIN.	TYP.	MAX.	UNIT
Input Characteristics						
Input Offset Voltage	V _{IO1}		-	20	60	μV
	V _{IO2}	Ta=-40 to +85°C	-	20	100	μV
Input Offset Voltage Drift	ΔV _{IO} /T	Ta=-40→+25°C / Ta=+25°C→+85°C	-	0.3	0.9	μV/°C
Common Mode Input Voltage Range	V _{ICM1}		±13	±14	-	V
	V _{ICM2}	Ta=-40 to +85°C	±13	±13.5	-	V
Common Mode Rejection Ratio	CMR1	V _{CM} =0V→-13V / V _{CM} =0V→+13V	130	140	-	dB
	CMR2	Ta=-40 to +85°C, V _{CM} =0V→-13V / V _{CM} =0V→+13V	120	140	-	dB
Supply Voltage Rejection Ratio	SVR1	V ⁺ /V=±3V to ±18V	115	125	-	dB
	SVR2	Ta=-40 to +85°C, V ⁺ /V=±3V to ±18V	110	120	-	dB
Input Bias Current	I _{B1}		-0.2	1.2	2.8	nA
	I _{B2}	Ta=-40 to +85°C	-1.5	1.7	6	nA
Input Bias Current Drift	ΔI _B /T	Ta=-40→+85°C	-	8	60	pA/°C
Input Offset Current	I _{IO1}		-	0.3	2.8	nA
	I _{IO2}	Ta=-40 to +85°C	-	0.3	4.5	nA
Input Offset Current Drift	ΔI _{IO} /T	Ta=-40→+85°C	-	1.5	72	pA/°C
Differential Input Impedance	R _{ID}	Theoretical value by design.	-	90	-	MΩ
Common-Mode Input Impedance	R _{IC}	Theoretical value by design.	-	800	-	GΩ
Input Offset Voltage Trim	V _{IOtri}	R _p =20kΩ	-	±3	-	mV
Voltage Gain	Av1	R _L =2kΩ, V _O =-10V→0V / 0V→+10V / -10V→+10V	130	142	-	dB
	Av2	Ta=-40 to +85°C, R _L =2kΩ, V _O =-10V→0V / 0V→+10V / -10V→+10V	126	136	-	dB

● DC CHARACTERISTICS

PARAMETER	SYMBOL	TEST CONDITION	MIN.	TYP.	MAX.	UNIT
Output Characteristics						
Maximum Output Voltage	V_{OM1}	$R_L=10k\Omega$	± 13.5	± 14.0	-	V
	V_{OM2}	$T_a=-40$ to $+85^\circ\text{C}$, $R_L=10k\Omega$	± 13.0	± 14.0	-	V
	V_{OM3}	$R_L=2k\Omega$	± 12.5	± 13.0	-	V
	V_{OM4}	$T_a=-40$ to $+85^\circ\text{C}$, $R_L=2k\Omega$	± 12.0	± 13.0	-	V
	V_{OM5}	$R_L=1k\Omega$	± 12.0	± 12.5	-	V
Output Impedance	R_o	Open-Loop	-	60	-	Ω
Supply Characteristics						
Supply Current	I_{CC1}	$A_V=+1$, $R_L=\infty$	-	1.6	2	mA
	I_{CC2}	$T_a=-40$ to $+85^\circ\text{C}$, $A_V=+1$, $R_L=\infty$	-	1.7	2.5	mA
	I_{CC3}	$V^+V^-=\pm 3\text{V}$, $A_V=+1$, $R_L=\infty$	-	0.58	0.75	mA
Power Dissipation	P_{D1}	$A_V=+1$, $R_L=\infty$	-	50	60	mW
	P_{D1}	$V^+V^-=\pm 3\text{V}$, $A_V=+1$, $R_L=\infty$	-	4.2	5.4	mW

● AC CHARACTERISTICS

PARAMETER	SYMBOL	TEST CONDITION	MIN.	TYP.	MAX.	UNIT
Frequency Characteristics						
Unity Gain Frequency	f_T	$A_V=+100$, $R_L=2k\Omega$, $C_L=10\text{pF}$	-	1.1	-	MHz
Slew Rate	+SR	RISE, $A_V=+1$, $V_{IN}=1\text{Vpp}$, $R_L=2k\Omega$, $C_L=10\text{pF}$	0.1	0.3	-	V/ μs
	-SR	FALL, $A_V=+1$, $V_{IN}=1\text{Vpp}$, $R_L=2k\Omega$, $C_L=10\text{pF}$	0.1	0.3	-	V/ μs
Noise Characteristics						
Equivalent Input Noise Voltage	V_{NI}	$f_o=1\text{Hz}$ to 100Hz	-	80	-	nVrms
Equivalent Input Noise Current	I_{NI}	$f_o=1\text{Hz}$ to 100Hz	-	3	-	pArms

NJM2729

■ ELECTRONIC CHARACTERISTICS

($V^+V^- = \pm 5V$ $T_a = +25^\circ C$, $V_{ICM} = 0V$ unless otherwise specified)

PARAMETER	SYMBOL	TEST CONDITION	MIN.	TYP.	MAX.	UNIT
Input Characteristics						
Input Offset Voltage	V_{IO1}	$T_a = -40$ to $+85^\circ C$	-	30	70	μV
	V_{IO2}		-	35	110	μV
Common Mode Input Voltage Range	V_{ICM1}	$T_a = -40$ to $+85^\circ C$	± 3	± 3.9	-	V
	V_{ICM2}		± 3	± 3.5	-	V
Common Mode Rejection Ratio	CMR1	$V_{CM} = 0V \rightarrow +3V / V_{CM} = 0V \rightarrow +3V$ $T_a = -40$ to $+85^\circ C$,	115	130	-	dB
	CMR2		$V_{CM} = 0V \rightarrow +3V / V_{CM} = 0V \rightarrow +3V$	105	125	-
Input Bias Current	I_{B1}	$T_a = -40$ to $+85^\circ C$	-0.2	0.7	2	nA
	I_{B2}		-0.2	1	6	nA
Input Offset Current	I_{IO1}	$T_a = -40$ to $+85^\circ C$	-	0.3	2.8	nA
	I_{IO2}		-	0.3	4.5	nA
Voltage Gain	A_{v1}	Open-Loop, $R_L = 2k\Omega$, $V_o = -3V \rightarrow 0V / 0V \rightarrow +3V / -3V \rightarrow +3V$ $T_a = -40$ to $+85^\circ C$, Open-Loop, $R_L = 2k\Omega$,	115	130	-	dB
	A_{v2}		$V_o = -3V \rightarrow 0V / 0V \rightarrow +3V / -3V \rightarrow +3V$	110	125	-
Output Characteristics						
Maximum Output Voltage	V_{OM1}	$R_L = 10k\Omega$	± 3.5	± 4.0	-	V
	V_{OM2}	$T_a = -40$ to $+85^\circ C$, $R_L = 10k\Omega$	± 3.5	± 4.0	-	V
	V_{OM3}	$R_L = 2k\Omega$	± 3.5	± 4.0	-	V
	V_{OM4}	$T_a = -40$ to $+85^\circ C$, $R_L = 2k\Omega$	± 3.5	± 4.0	-	V
Supply Characteristics						
Supply Current	I_{CC1}	$A_v = +1$, $R_L = \infty$	-	0.85	1.1	mA
	I_{CC2}	$T_a = -40$ to $+85^\circ C$, $A_v = +1$, $R_L = \infty$	-	0.9	1.25	mA

● EXPLANATION OF MEASUREMENT CONDITION

PARAMETER	Explanation
Input Offset Voltage Drift	$\text{Input Offset Voltage Drift} = \Delta V_{IO} / \Delta t$ $\Delta t : \text{Amount of Temperature change.}$ $\Delta V_{IO} : \text{Amount of Input Offset Voltage.}$
Common Mode Input Voltage range	A range of input voltage at which the operational amplifier can function.
Common Mode Rejection Ratio	$\text{CMR} = 20 \log (\Delta V_{IN} / \Delta V_{IO}) $ $\Delta V_{IN} : \text{Amount of Input Voltage.}$ $\Delta V_{IO} : \text{Amount of Input Offset Voltage.}$
Supply Voltage Rejection Ratio	$\text{SVR} = 20 \log (\Delta V_S / \Delta V_{IO}) $ $\Delta V_S : \text{Amount of supply Voltage.}$ $\Delta V_{IO} : \text{Amount of Input Offset Voltage.}$
Common Mode Input Impedance	$R_{INCM} = \Delta V_{IN} / \Delta I_B$ $\Delta V_{IN} : \text{Amount of Input Voltage.}$ $\Delta I_B : \text{Amount of Input bias current.}$
Voltage Gain	$AV = 20 \log (\Delta V_{IN} / \Delta V_O) $ $\Delta V_O : \text{Amount of output Voltage.}$ $\Delta V_{IN} : \text{Amount of Input Voltage.}$

■ TYPICAL CHARACTERISTICS

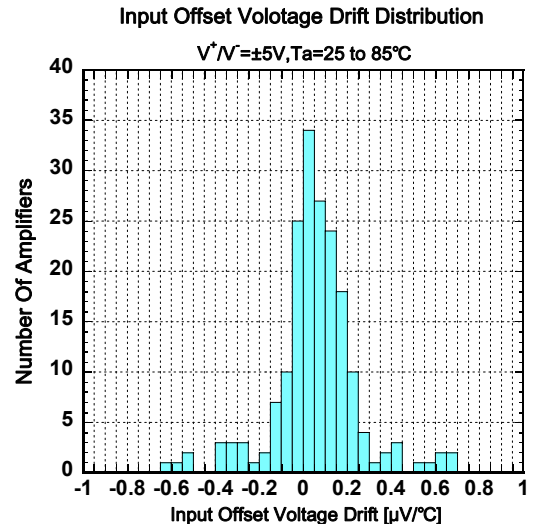
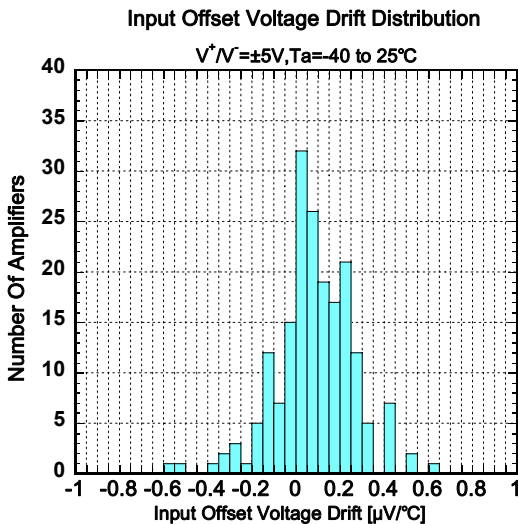
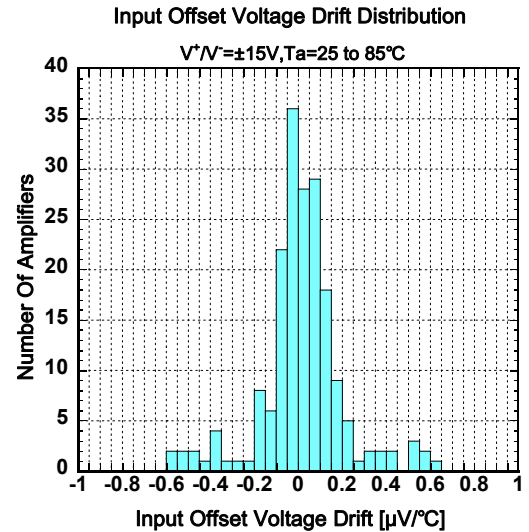
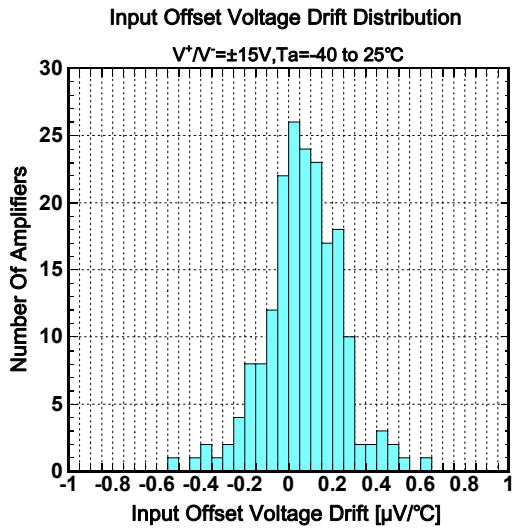
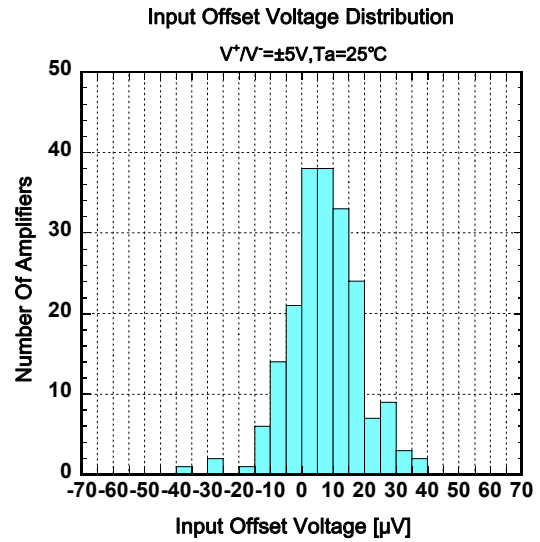
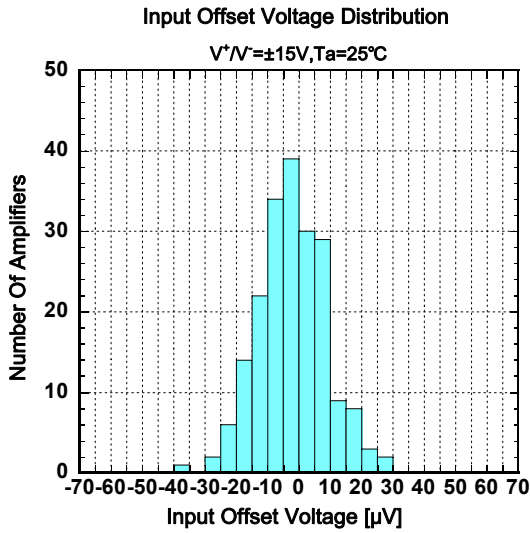

■ TYPICAL CHARACTERISTICS

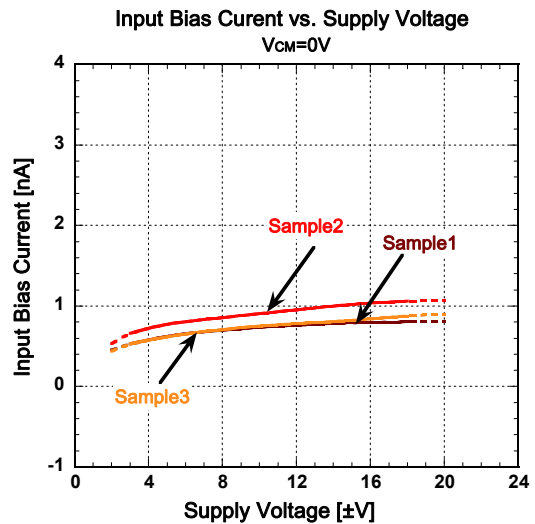
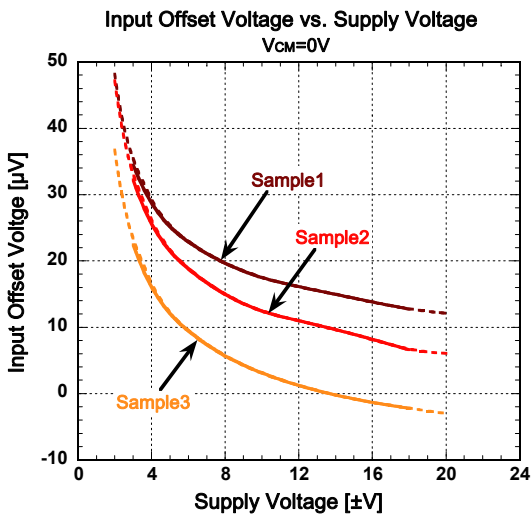
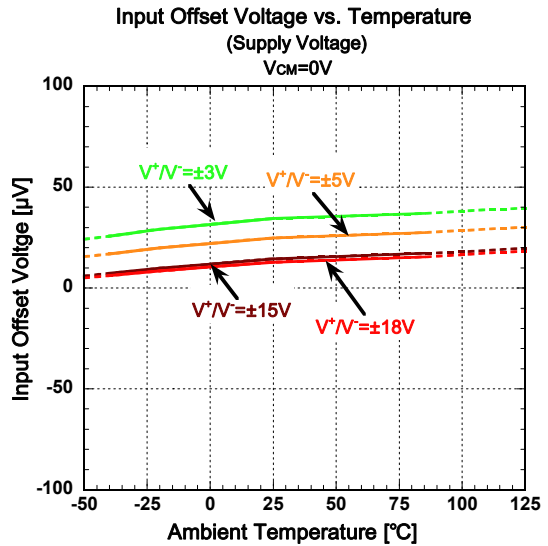
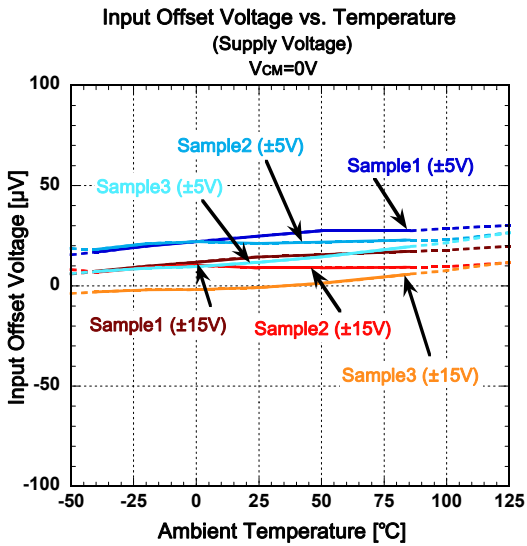
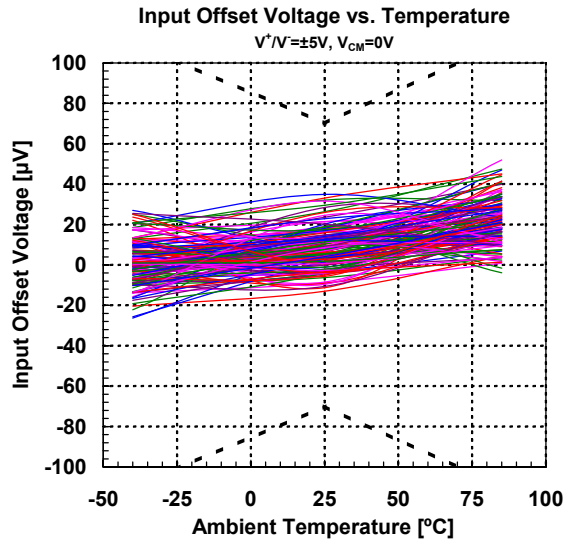
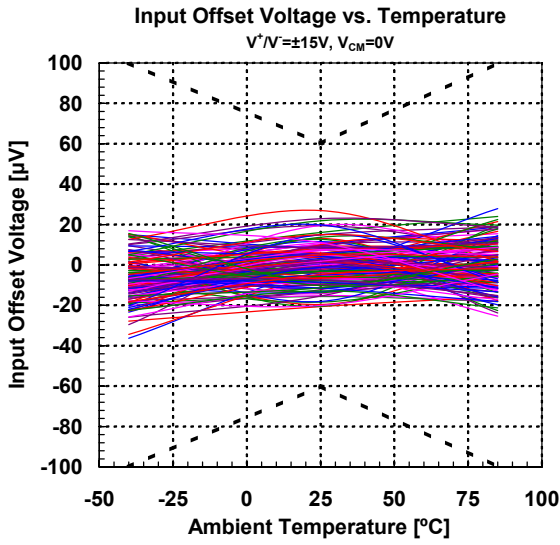

■ TYPICAL CHARACTERISTICS

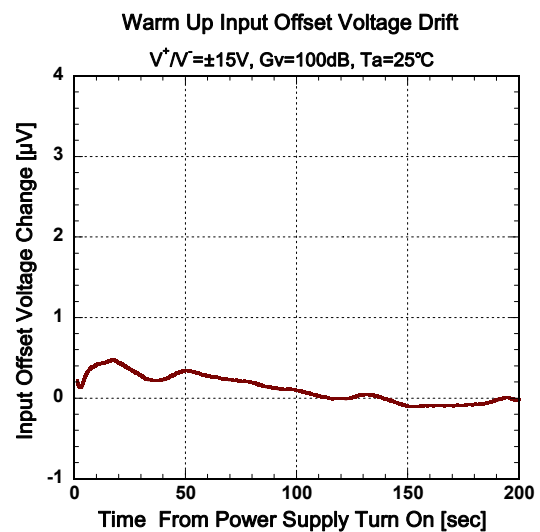
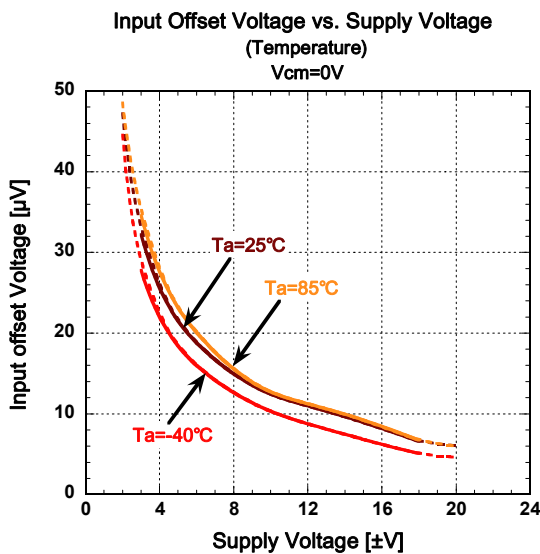
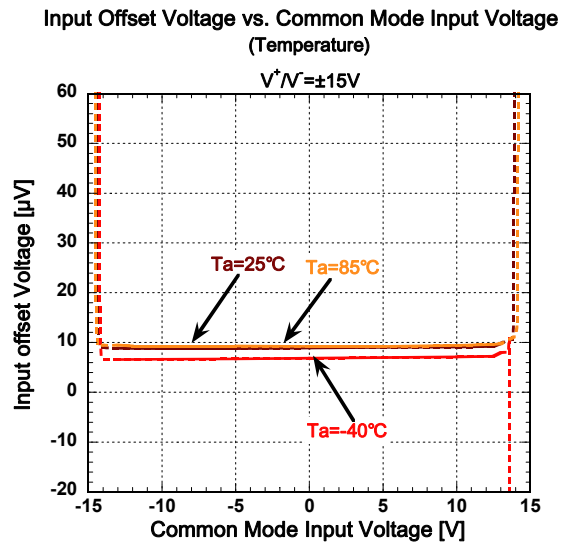
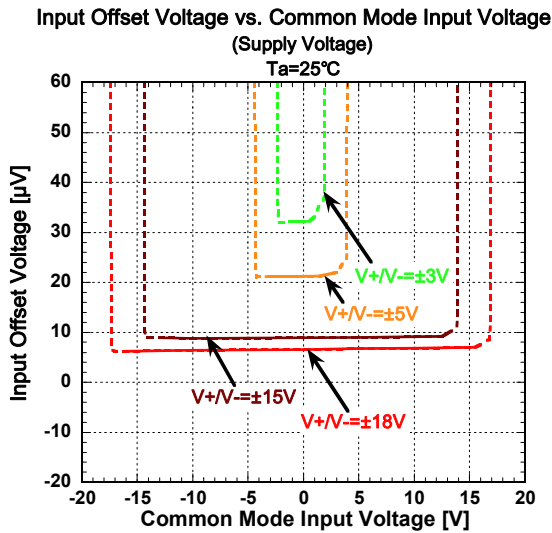
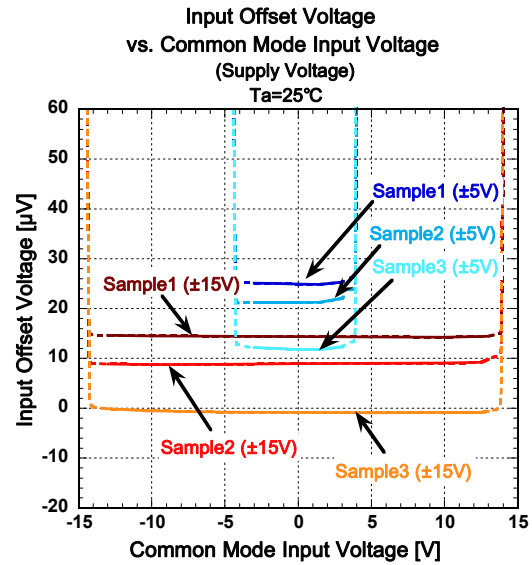
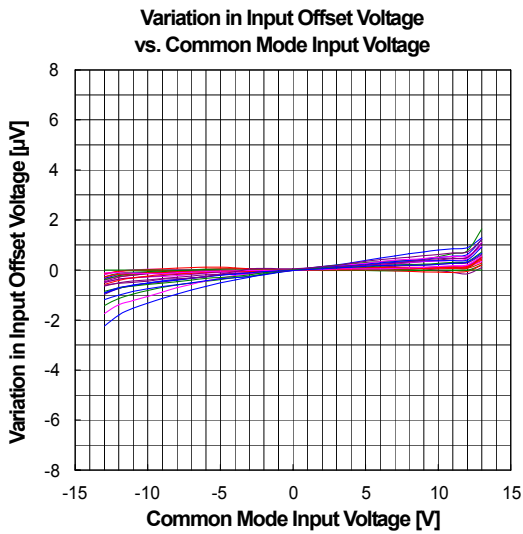

■ TYPICAL CHARACTERISTICS

Input Offset Voltage vs. Output Voltage

$V^+ / V^- = \pm 15V$, $G_v = 100dB$, $R_L = 2k\Omega$, $T_a = 25^\circ C$

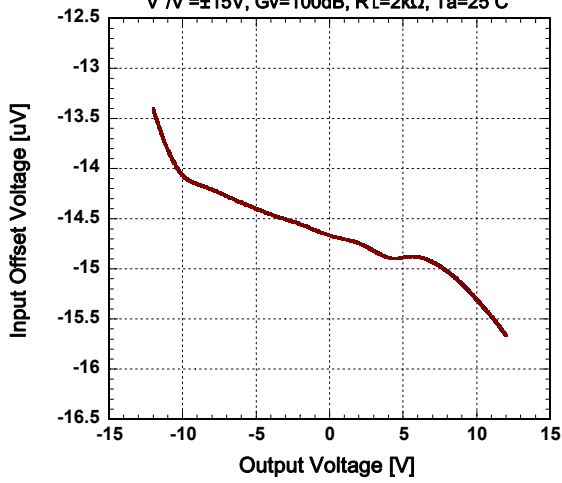

Input Offset Voltage vs. Trim Resistance

$V^+ / V^- = \pm 15V$, $G_v = 60dB$, $T_a = 25^\circ C$

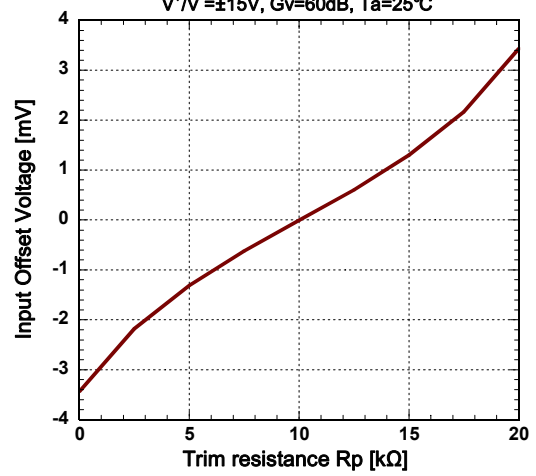

Equivalent Input Noise Voltage

$V^+ / V^- = \pm 15V$, $BP = 1 \sim 100Hz$

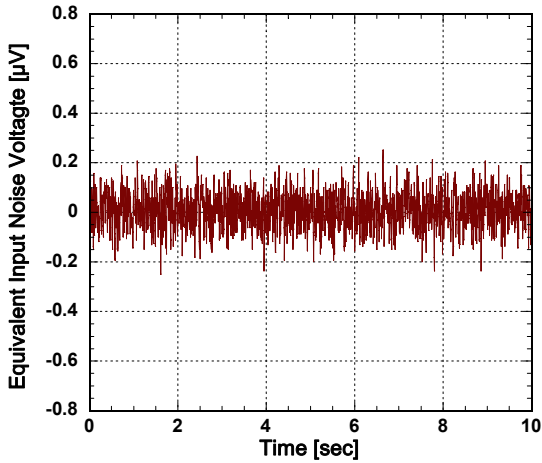

Equivalent Input Noise Voltage

$V^+ / V^- = \pm 5V$, $BP = 1 \sim 100Hz$

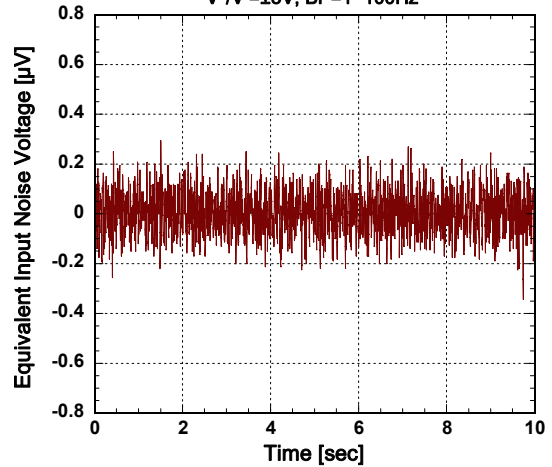

Equivalent Input Noise Voltage

$R_f = 10k\Omega$, $R_s = 100\Omega$, $R_g = 100\Omega$, $T_a = 25^\circ C$

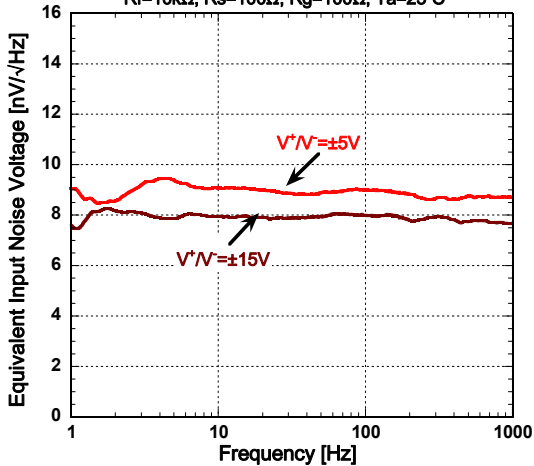

■ TYPICAL CHARACTERISTICS

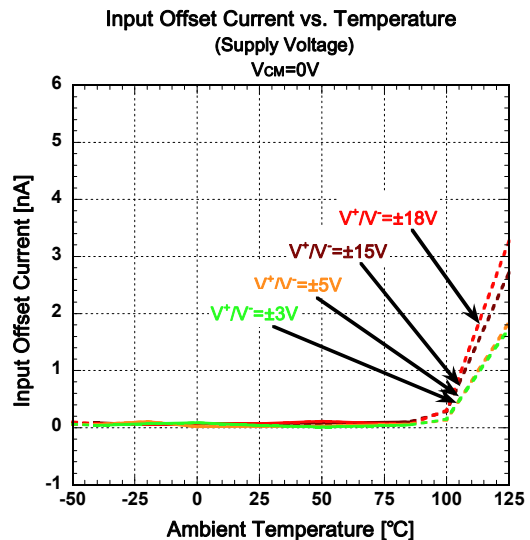
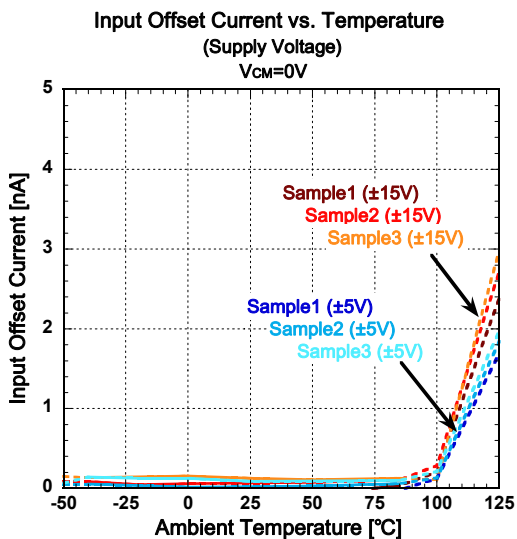
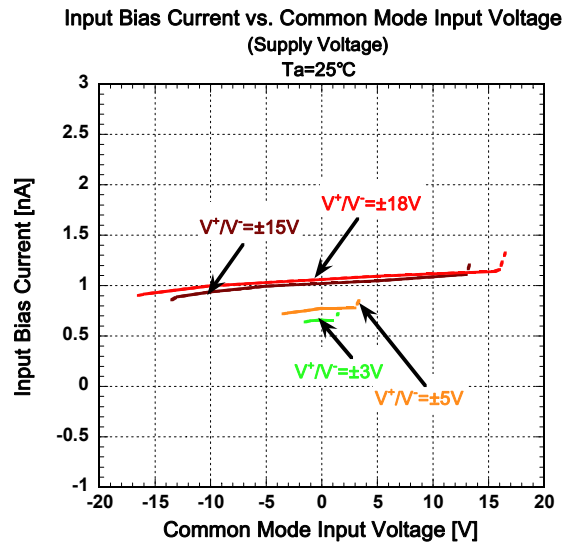
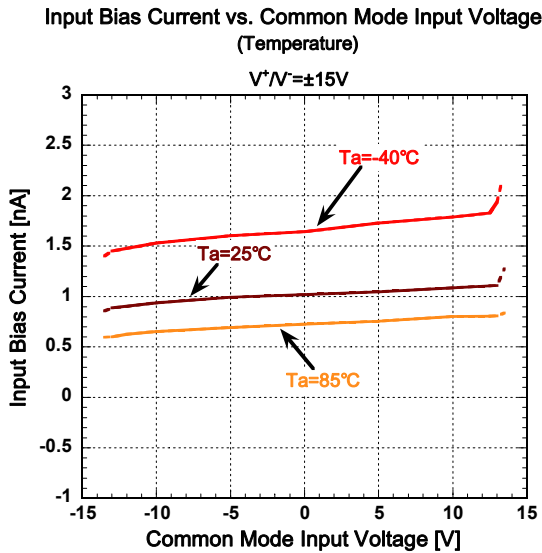
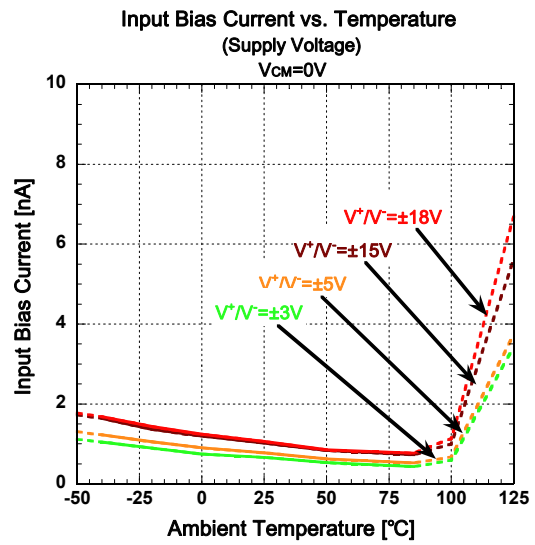
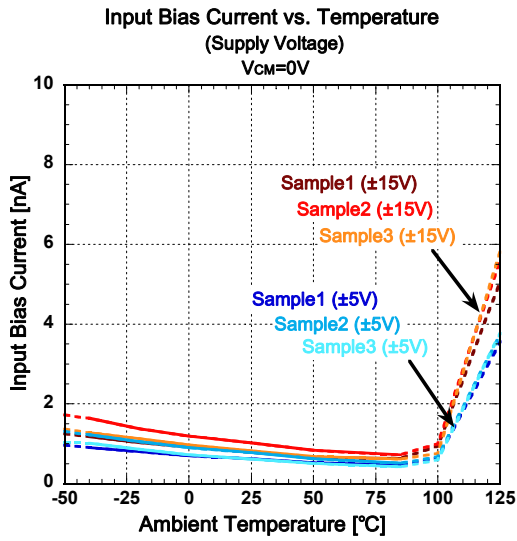

■ TYPICAL CHARACTERISTICS

Input Offset Current vs. Common Mode Input Voltage
(Temperature)

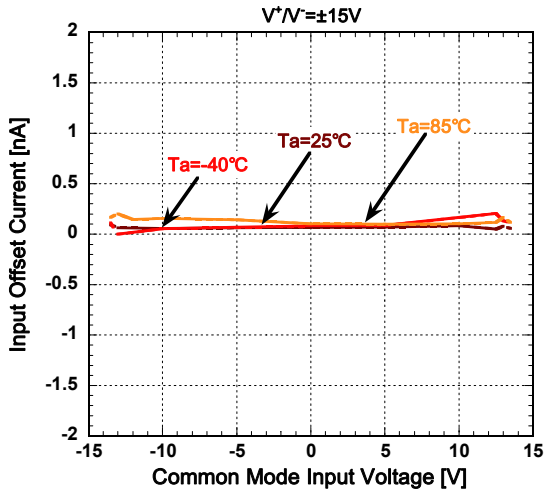

Input Offset Current vs. Common Mode Input Voltage
(Supply Voltage)

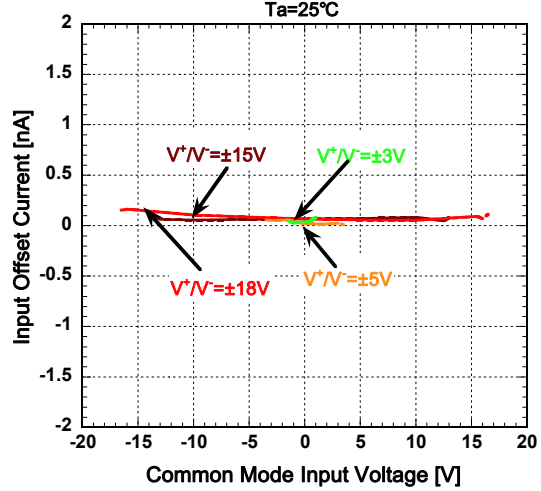

Common Mode Rejection Ratio vs. Temperature
(Supply Voltage)

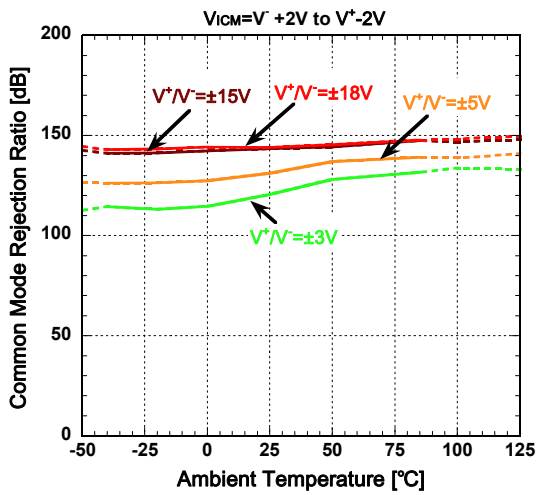

Common Mode Rejection Ratio vs. Frequency

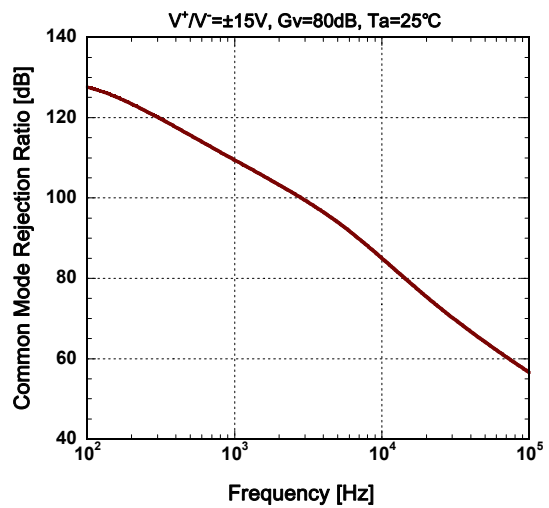

Supply Voltage Rejection Ratio vs. Frequency

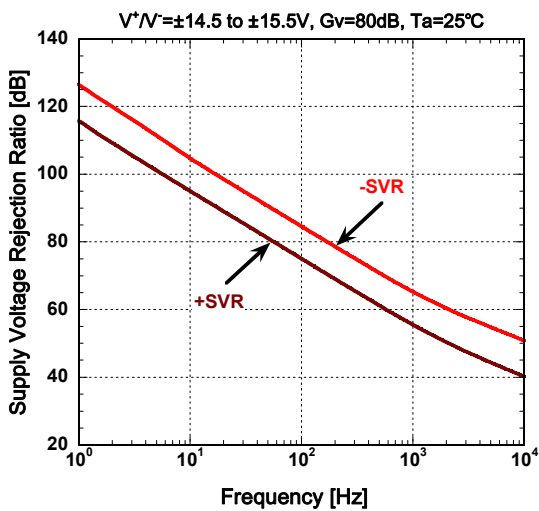

Supply Voltage Rejection Ratio vs. Temperature

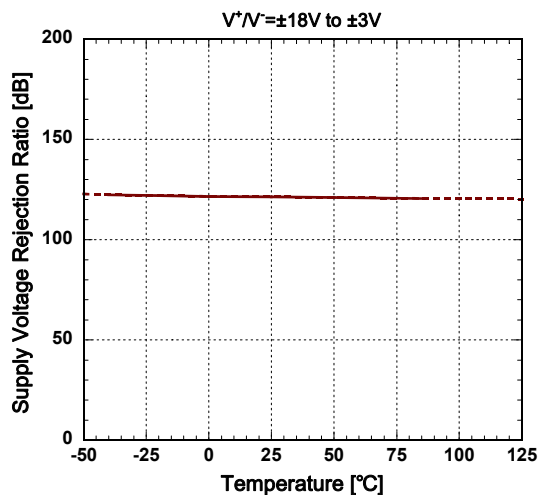

■ TYPICAL CHARACTERISTICS

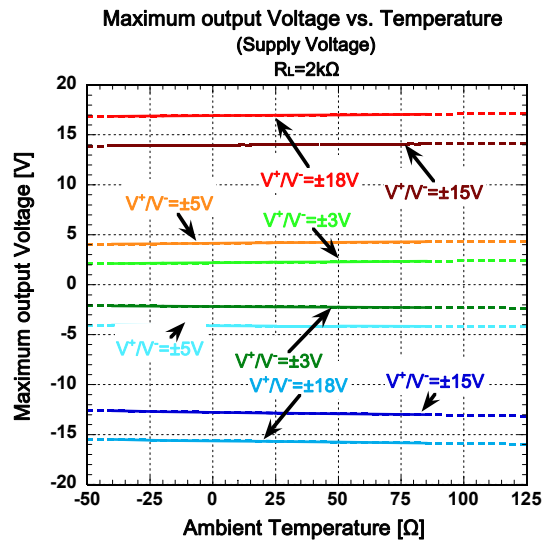
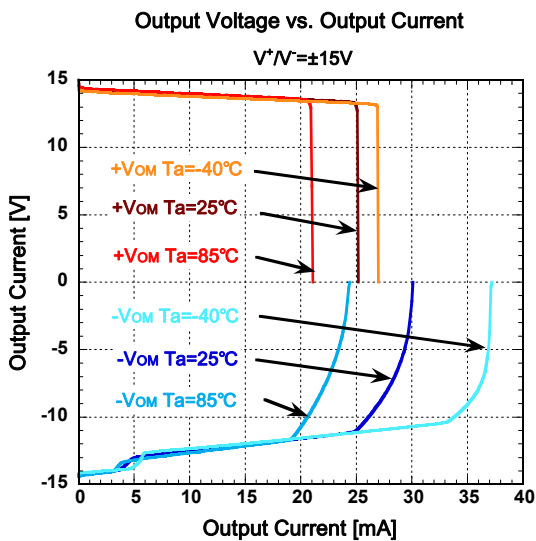
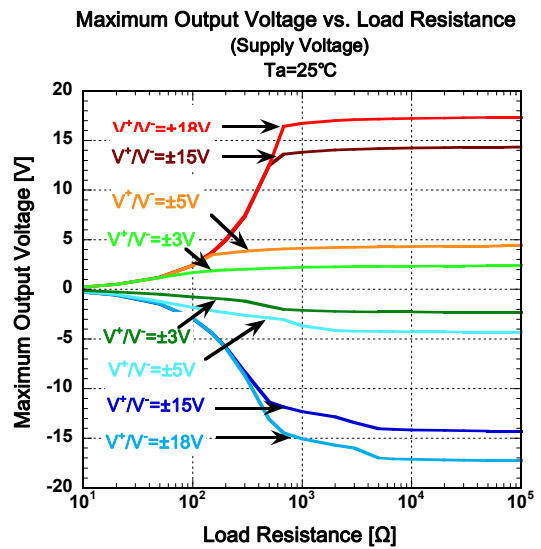
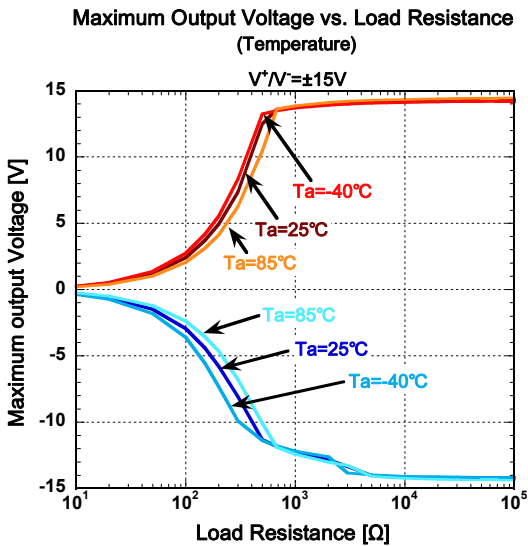
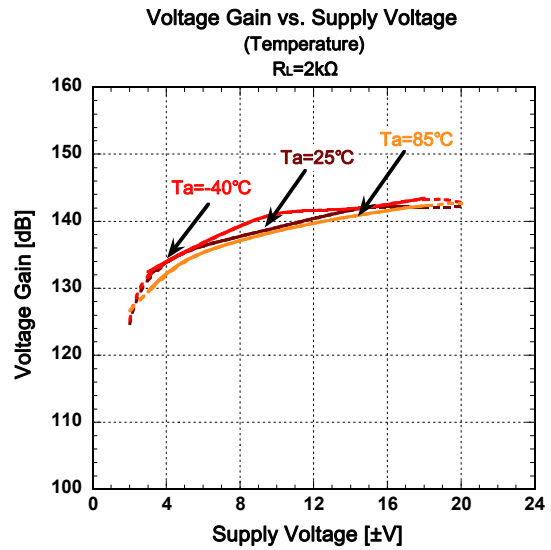
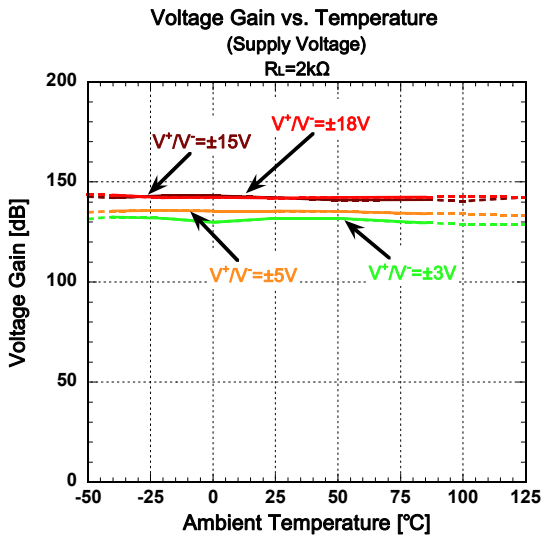

■ TYPICAL CHARACTERISTICS

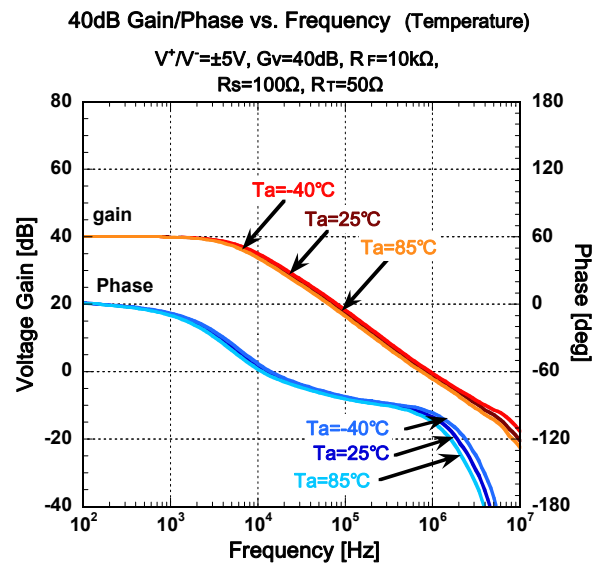
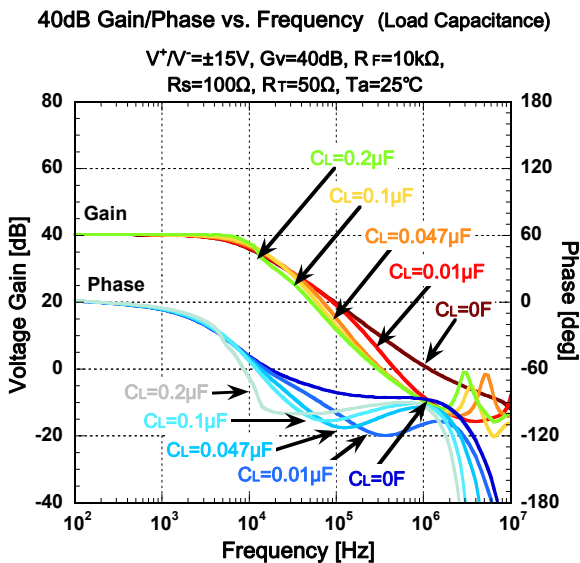
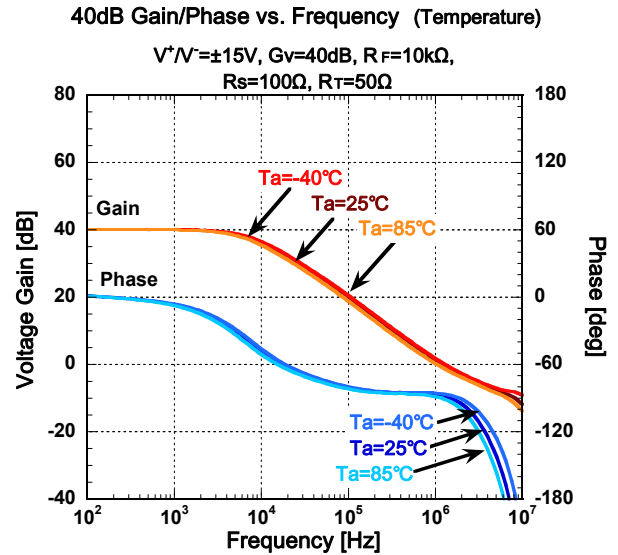
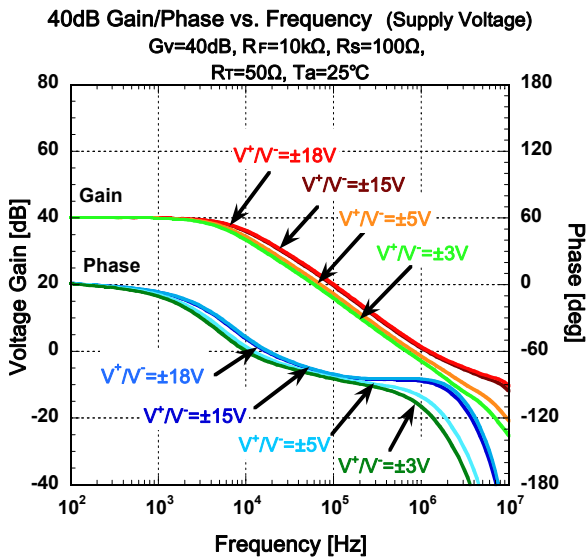
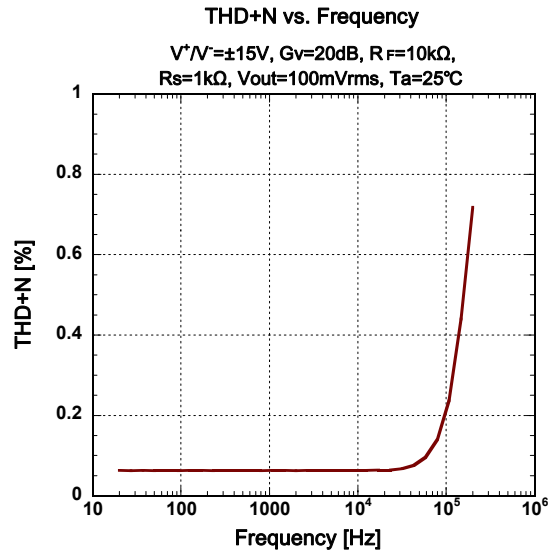
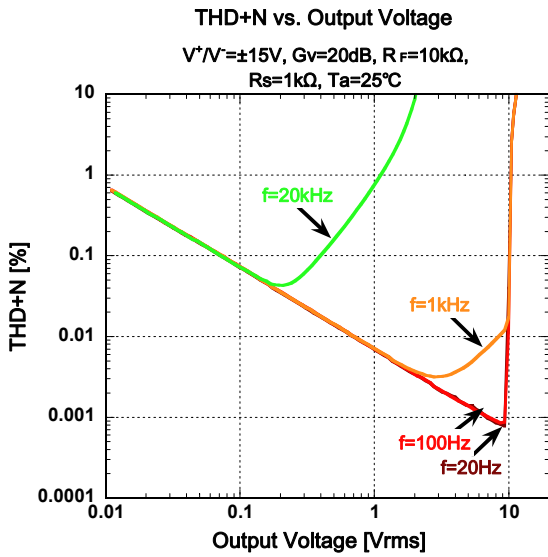

■ TYPICAL CHARACTERISTICS

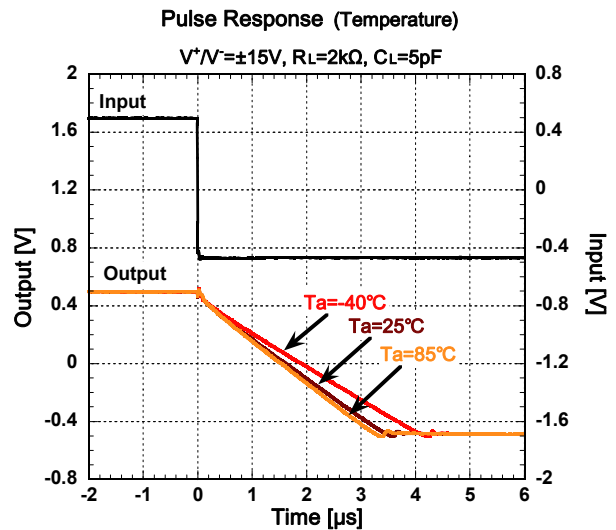
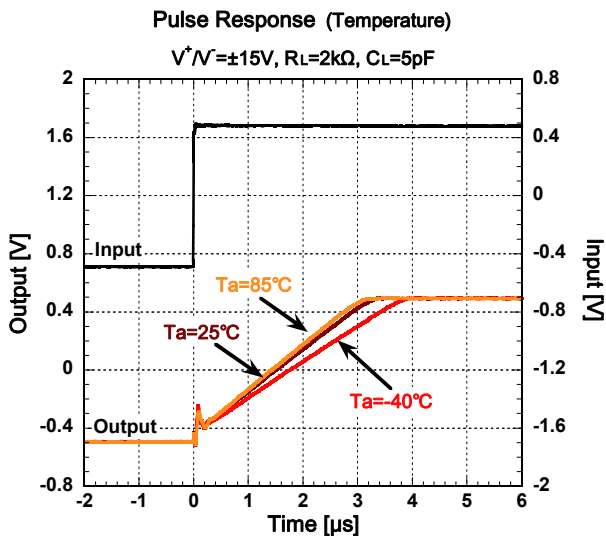
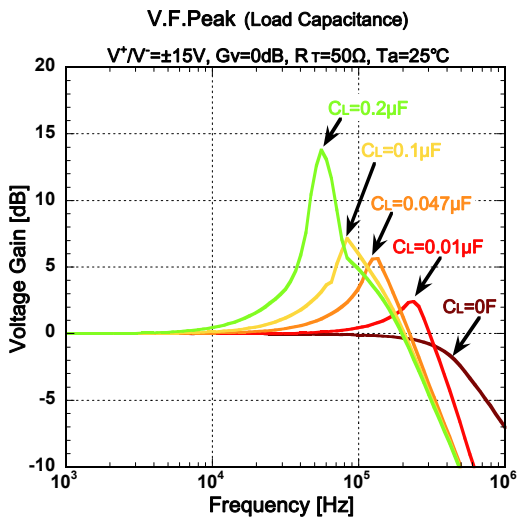
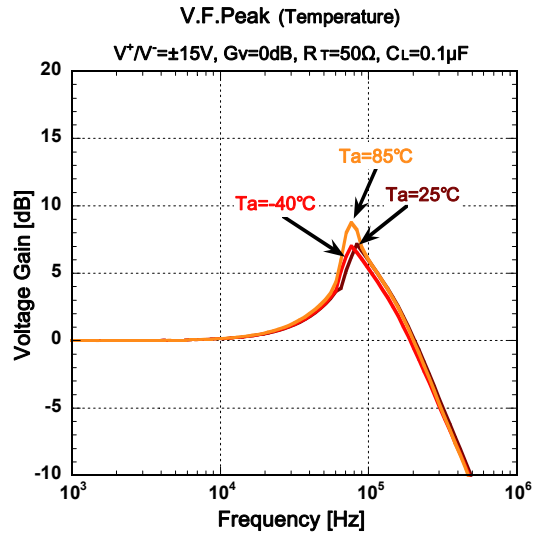
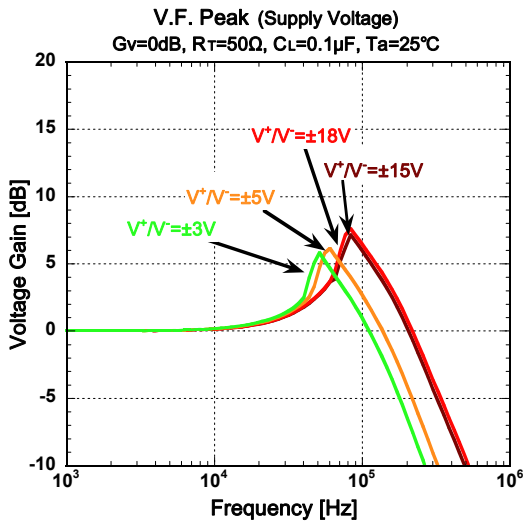

■ TYPICAL CHARACTERISTICS

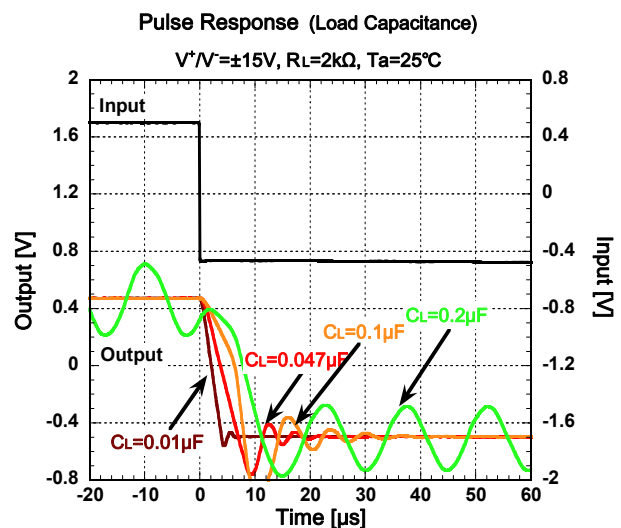
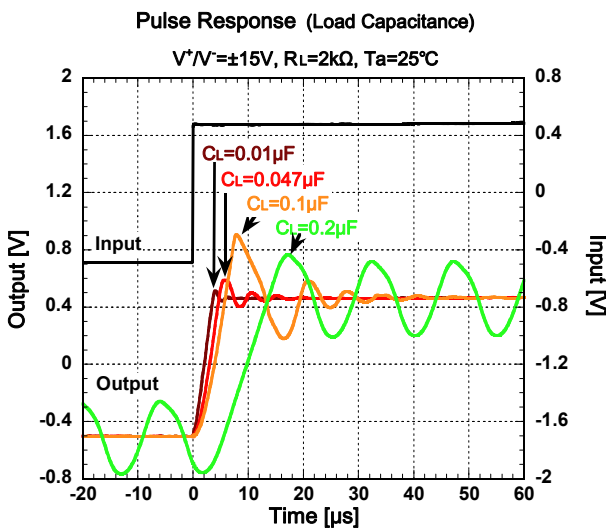
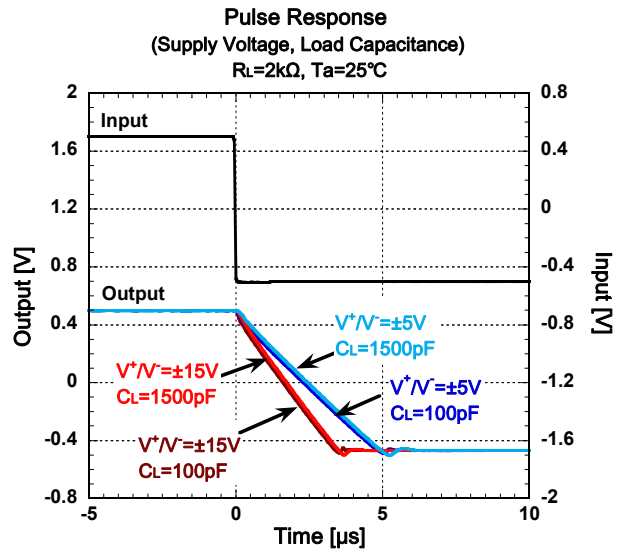
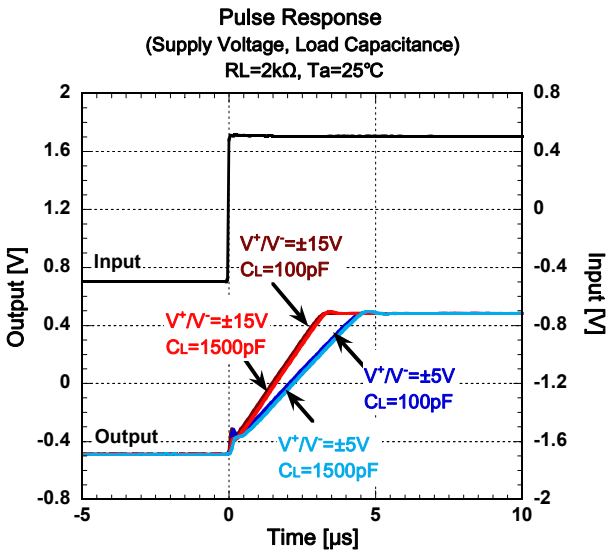
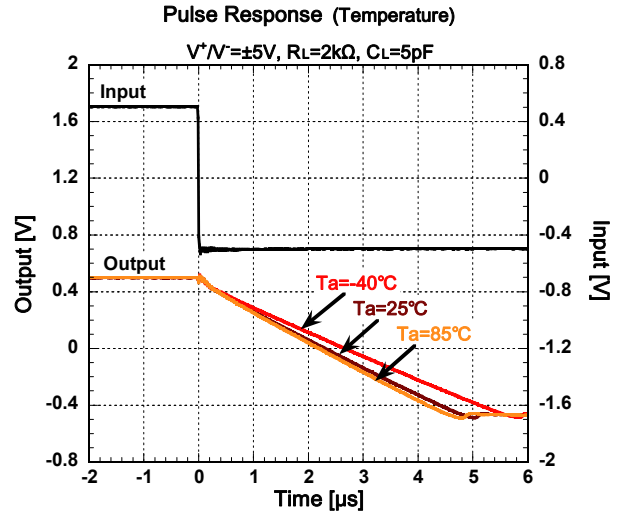
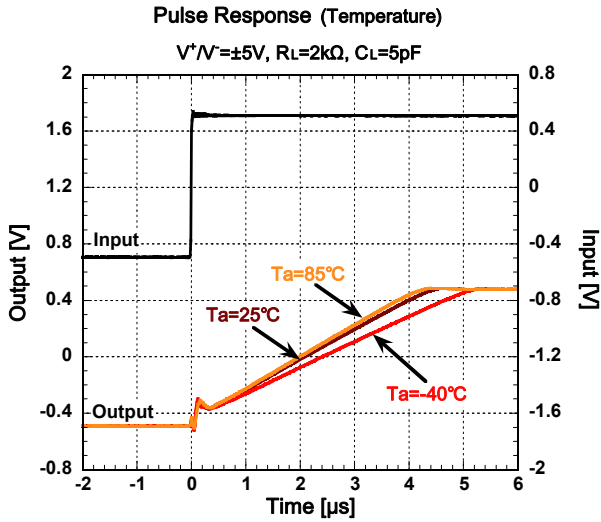

■ TYPICAL CHARACTERISTICS

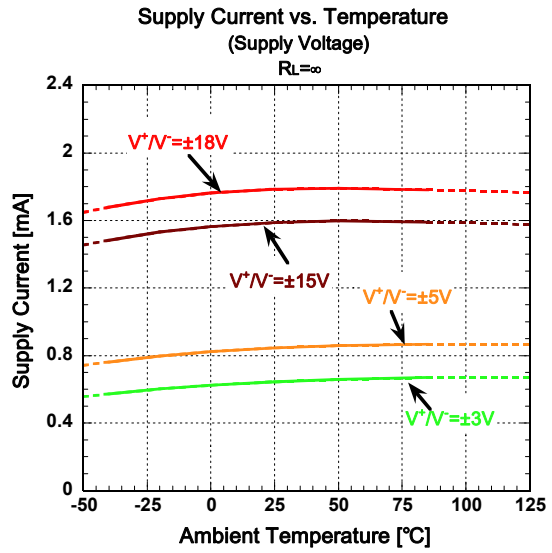
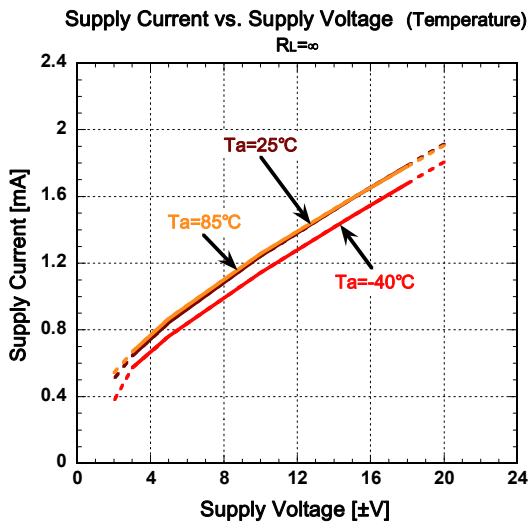
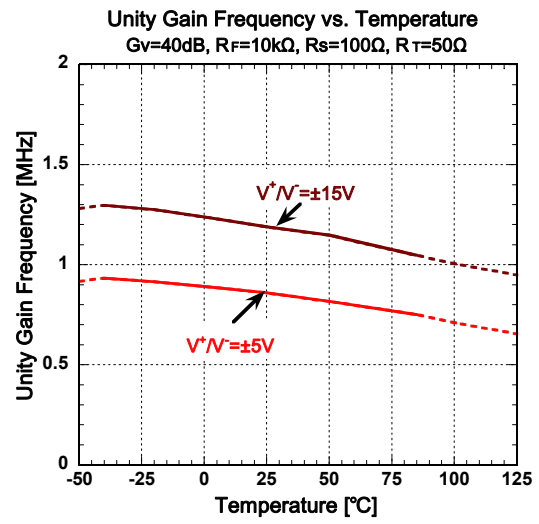
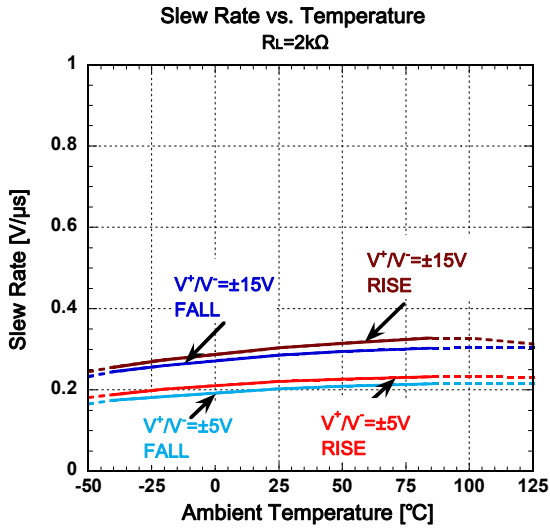

■ Application Information

● Power Supply Bypassing

The NJM2729 is a high precision operational amplifier featuring low offset voltage, high voltage gain, high CMR, high SVR and so on. To maximize such a high performance with stable operation, the NJM2729 should be operated by clean and low impedance supply voltage. So, the bypass capacitor should be connected to the NJM2729's both power supply terminals (V+ and V-) as shown in Fig.1. The bypass capacitors should be placed as close as possible to IC package

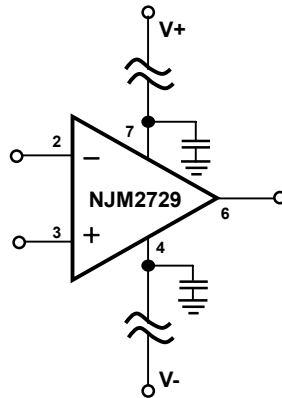

Fig.1 Power Supply Bypassing Circuit

● Thermoelectric Effect

The NJM2729 is a high precision operational amplifier featuring low offset voltage and low offset voltage thermal drift. To achieve such a high performance, take care about thermoelectric effect possibly occurs on each input terminal of the NJM2729. Generally, if there are thermal mismatches at the junction of different types of metals, the thermoelectric voltage (Seebeck effect) occurs at the junction. The thermoelectric voltages possibly occur at the junction of PCB metal patterns and NJM2729's each input terminal metal. If there is thermal mismatch in-between NJM2729's each input terminal metal, the thermoelectric voltages generated on each input terminal possibly have different voltage each. This voltage difference causes offset voltage and offset voltage thermal drift of the NJM2729. To minimize this voltage difference, the thermal mismatch in-between NJM2729's each input terminal and PCB metal should be minimized.

● Offset Voltage Adjustment

The NJM2729 has offset voltage trim terminals (pin1 and pin8) as shown in below Fig.2. By connecting external potentiometer in the range of 20Kohm, the offset voltage trim range is $\pm 3\text{mV}$. This offset voltage trim is effective only for offset voltage at room temperature, not for offset voltage thermal drift. If offset voltage adjustment is not in use, leave pin1 and pin8 open (un-connected).

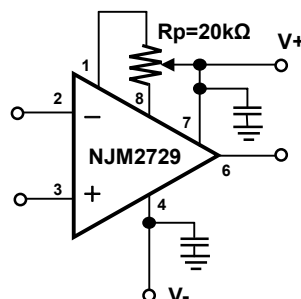

Fig.2 Offset Voltage Trim Circuit

NJM2729

•Differential Amplifier

Differential amplifier (see below Fig.3) is used in high accuracy circuit to improve common mode rejection ratio (CMR). A matching between the ratio $R_1/R_2 = R_3/R_4$ and $R_1=R_3$ makes the high CMR. For example, acceptable error range to obtain CMR of 130dB or more is about 0.1ppm.

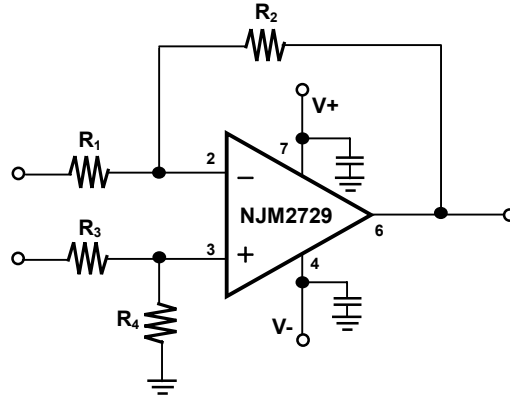

Fig.3 Differential Amplifier

[CAUTION]
The specifications on this data book are only given for information, without any guarantee as regards either mistakes or omissions. The application circuits in this data book are described only to show representative usages of the product and not intended for the guarantee or permission of any right including the industrial rights.