



## NJM2725

### 160MHz, 1.4nV/ $\sqrt{\text{Hz}}$ , Operational Amplifier

#### FEATURES

(V<sup>+</sup> = 5V, V<sup>-</sup> = 0V, Typical value)

● GBW	160MHz
● Low Noise (f = 100kHz)	1.4nV/ $\sqrt{\text{Hz}}$
● Input Offset Voltage	1mV max
● Supply Voltage	4V to 10V
● Common-Mode Input Voltage Range	1.5V to 3.8V
● Output Voltage (R <sub>L</sub> = 1k $\Omega$ )	1.3V to 3.5V
● Supply Current	4mA/ch
● Operating Temperature	-40°C to 125°C
● Slew Rate	15V/ $\mu\text{s}$
● Stable Gain $\geq 2$	
● Package	MSOP8 (VSP8) (U.D.) SOP8

#### APPLICATIONS

- Low Noise Instrumentation Front End
- Ultrasound Preamp
- High Speed Low Noise Active Filter
- ADC Input Buffer Amplifier
- Sensor Interface

#### DESCRIPTION

The NJM2725 is a dual high speed voltage feedback operational amplifier designed for ease of use in a high speed and low noise applications.

The combination of 1.4nV/ $\sqrt{\text{Hz}}$  voltage noise and 160MHz bandwidth makes the NJM2725 suitable for ultra-small signal and high frequency applications such as high speed photosensors, ultrasound sensors, active filters and other wideband applications. NJM2725 can be easily configured as a low noise amplifier, and it can also be used as a high performance ADC front end in combination with rail-to-rail op amps.

NJM2725 is stable for Gain  $\geq 2$  or Gain  $\leq -1$ . Packages for this device is the 8pin SOP and the 8pin MSOP8 (VSP8) and is offered in the extended industrial temperature grade of -40°C to 125°C.

#### ■ GBW and Noise

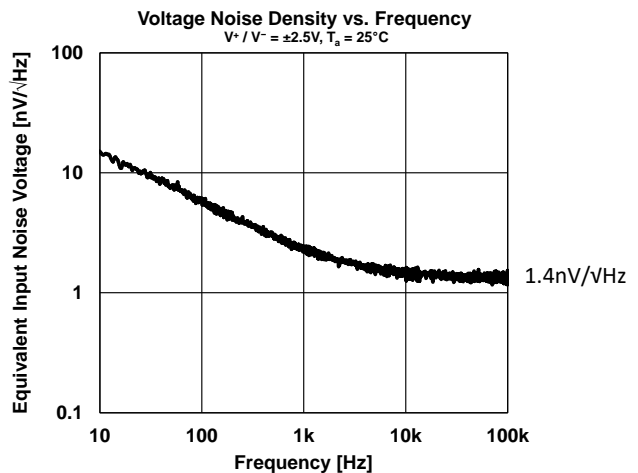
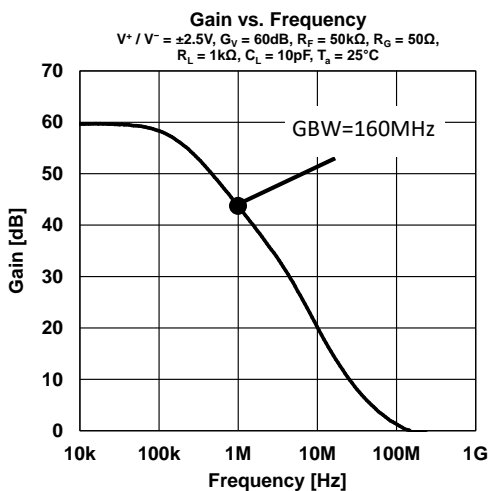

■ **PRODUCT NAME INFORMATION**

NJM2725  a   (bbb)

Description of configuration

Suffix	Parameter	Description
a	Package code	Indicates the package. Refer to the order information.
bbb	Packing	Refer to the packing specifications.

■ **ORDER INFORMATION**

Product Name	Package	RoHS	Halogen-Free	Terminal Finish	Marking	Weight (mg)	MOQ (pcs)
NJM2725G (TE1)	Under Development SOP8	Yes	Yes	Pure Sn	2725	88	2500
NJM2725R (TE1)	MSOP8 (VSP8)	Yes	-	Sn2Bi	2725	21	2000

■ PIN DESCRIPTIONS (8 Pin)

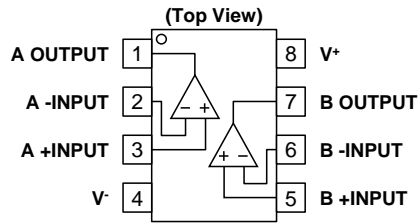

Pin No.		Symbol	I/O	Description
SOP8	VSP8			
1	1	A OUTPUT	O	Output channel A
2	2	A -INPUT	I	Inverting input channel A
3	3	A +INPUT	I	Non-inverting input channel A
7	7	B OUTPUT	O	Output channel B
6	6	B -INPUT	I	Inverting input channel B
5	5	B +INPUT	I	Non-inverting input channel B
8	8	V+	-	Positive supply
4	4	V-	-	Negative supply or Ground (single supply)

■ BLOCK DIAGRAM

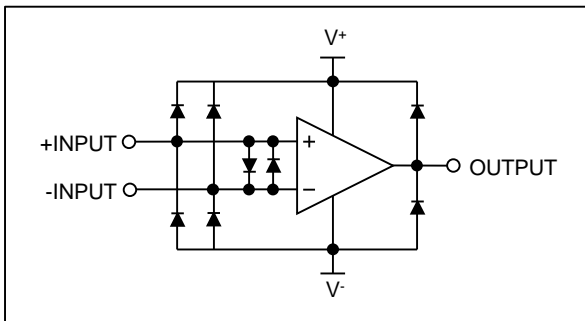

■ ABSOLUTE MAXIMUM RATINGS

Parameter	Symbol	Rating	Unit
Supply Voltage	$V^+ - V^-$	11	V
Input Voltage *1	$V_{IN}$	$V^- - 0.3$ to $V^+ + 0.3$	V
Input Current *1	$I_{IN}$	$\pm 1$	mA
Differential Input Voltage *2	$V_{ID}$	$\pm 1.2$	V
Output Short-Circuit Duration *3		Continuous	
Storage Temperature	$T_{stg}$	-65 to 150	°C
Junction Temperature *4	$T_j$	150	°C

\*1 Input voltages outside the supply voltage will be clamped by ESD protection diodes. If the input voltage exceeds the supply voltage, the current must be limited 1 mA or less by using a restriction resistance. Input current inflow is positive and Input current outflow is negative.

\*2 Differential voltage is the voltage difference between +INPUT and -INPUT.

\*3 Short-circuit can cause excessive heating and destructive dissipation.

\*4 Calculate the power consumption of the IC from the operating conditions, and calculate the junction temperature with the thermal resistance.

Please refer to "Thermal characteristics" for the thermal resistance under our measurement board conditions.

**ABSOLUTE MAXIMUM RATINGS**

Electronic and mechanical stress momentarily exceeded absolute maximum ratings may cause permanent damage and may degrade the lifetime and safety for both device and system using the device in the field. The functional operation at or over these absolute maximum ratings is not assured.

■ THERMAL CHARACTERISTICS

Package	Measurement Result		Unit
	Thermal Resistance ( $\theta_{ja}$ )	Thermal Characterization Parameter ( $\psi_{jt}$ )	
SOP8	125	43	°C/W
MSOP8 (VSP8)	189	53	

$\theta_{ja}$ : Junction-to-Ambient Thermal Resistance

$\psi_{jt}$ : Junction-to-Top Thermal Characterization Parameter

Mounted on glass epoxy board (76.2 mm x 114.3 mm x 1.6 mm: based on EIA/JEDEC standard, 4-layer FR-4), internal Cu area: 74.2 mm x 74.2 mm.

■ ELECTROSTATIC DISCHARGE (ESD) PROTECTION VOLTAGE

Parameter	Conditions	Protection Voltage
HBM	C = 100 pF, R = 1.5 k $\Omega$	$\pm 1000$ V
CDM	Direct CDM	$\pm 1000$ V

**ELECTROSTATIC DISCHARGE RATINGS**

The electrostatic discharge test is done based on JEITA ED-4701.

In the HBM method, ESD is applied using the power supply pin and GND pin as reference pins.

■ RECOMMENDED OPERATING CONDITIONS

Parameter	Symbol	Conditions	Rating	Unit
Supply Voltage	$V^+ - V^-$		4 to 10	V
Operating Temperature	$T_a$		-40 to 125	°C

**RECOMMENDED OPERATING CONDITIONS**

All of electronic equipment should be designed that the mounted semiconductor devices operate within the recommended operating conditions. The semiconductor devices cannot operate normally over the recommended operating conditions, even if when they are used over such conditions by momentary electronic noise or surge. And the semiconductor devices may receive serious damage when they continue to operate over the recommended operating conditions.

■ TYPICAL APPLICATION CIRCUIT

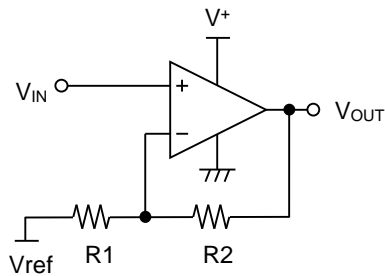

Non-inverting amplifier  
 Stable Gain  $\geq 2$

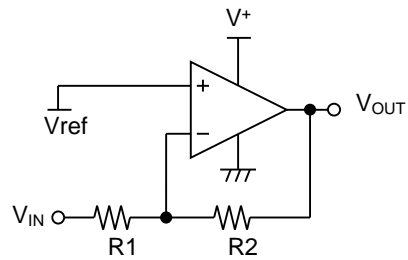

Inverting amplifier  
 Stable Gain  $\leq -1$

■ ELECTRICAL CHARACTERISTICS

$V^+ = 5V, V^- = 0V, V_{COM} = V^+/2, R_L = 5k\Omega$  to  $V_{COM}, T_a = 25^\circ C$ , unless otherwise specified.

Parameter	Symbol	Test Conditions	Min	Typ	Max	Unit
<b>INPUT CHARACTERISTICS *1</b>						
Input Offset Voltage	$V_{IO}$		-	0.5	1	mV
Input Bias Current	$I_B$		-	4.6	10	$\mu A$
Input Offset Current	$I_{IO}$		-	0.5	5	$\mu A$
Input Offset Voltage Drift	$\Delta V_{IO}/\Delta T$		-	1	-	$\mu V/^\circ C$
Input Resistance	$R_{IN}$		-	12000	-	$\Omega$
Input Capacitance	$C_{IN}$		-	2.8	-	pF
Open-Loop Voltage Gain	$A_V$	$V_O = 1.5V$ to $3.5V$	90	115	-	dB
Common-Mode Rejection Ratio	CMR	$V_{COM} = V^- + 1.5$ to $V^+ - 1.2$	70	100	-	dB
Common-Mode Input Voltage Range	$V_{ICM}$	Guaranteed by CMR	$V^- + 1.5$	-	$V^+ - 1.2$	V
<b>OUTPUT CHARACTERISTICS</b>						
High-level Output Voltage	$V_{OH}$	$R_L = 1k\Omega$ to $V^+/2$	$V^+ - 1.5$	$V^+ - 1.0$	-	V
Low-level Output Voltage	$V_{OL}$	$R_L = 1k\Omega$ to $V^+/2$	-	$V^- + 0.2$	$V^- + 1.3$	V
Output Current	$I_O$	Sourcing, $V_O = 3.5V$	-	25	-	mA
		Sinking, $V_O = 1.5V$	-	30	-	mA
<b>POWER SUPPLY</b>						
Supply Current per Amplifier	$I_{SUPPLY}$	No signal	-	4	5.8	mA
Supply Voltage Rejection Ratio	SVR	$V^+ = 4$ to $10V$	80	110	-	dB
<b>AC CHARACTERISTICS (Gain = 2)</b>						
Slew Rate	SR	$V_O = 1V_{PP}$	-	15	-	$V/\mu s$
Gain Bandwidth Product	GBW	$f = 1MHz$	-	160	-	MHz
Settling Time 0.1%	$t_s$	$V_O = 1V_{PP}$	-	0.13	-	$\mu s$
Gain Margin	$G_M$	$C_L = 50pF$	-	10	-	dB
Phase Margin	$\Phi_M$	$C_L = 50pF$	-	60	-	deg
Total Harmonic Distortion + Noise	THD+N	$V_O = 1V_{PP}, f = 1MHz$	-	0.1	-	%
Equivalent Input Noise Voltage	$e_n$	$f = 100kHz$	-	1.4	-	$nV/\sqrt{Hz}$
Equivalent Input Noise Current	$I_n$	$f = 100kHz$	-	1.5	-	$pA/\sqrt{Hz}$
Channel Separation	CS	$f = 1MHz$	-	80	-	dB

\*1 Input offset voltage and drift, Input bias and offset current are positive or negative, its absolute values are listed in electrical characteristics.

■ APPLICATION NOTE

Single and Dual Supply Voltage Operation

The NJM2725 works with both single supply and dual supply when the voltage supplied is between V+ and V-. These amplifiers operate from single 4V to 10V supply and dual ±2V to ±5V supply. The power supply pin should have bypass capacitor (i.e. 0.1µF).

No Phase Reversal

NJM2725 are designed to prevent phase reversal at the input voltage above the supply voltage. Figure1 shows no phase reversal characteristics with the input voltage exceeding the supply voltage.

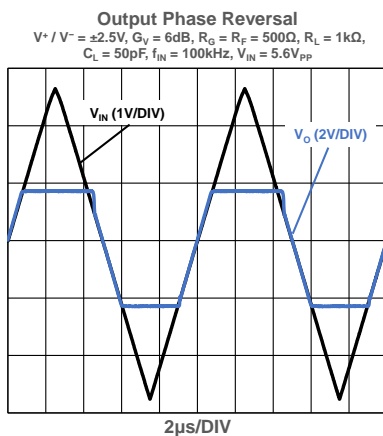

Figure1. No phase reversal

Common-Mode Input Voltage Range

When the supply voltage does not meet the condition of electrical characteristics, the range of common-mode input voltage is as follows:

$$V_{ICM} (typ.) = V^- + 1.5V \text{ to } V^+ - 1.2V \text{ (Ta = 25°C)}$$

Difference of V<sub>ICM</sub> when Temperature change, refer to typical characteristic graph.

During designing, consider variations in characteristics for use with allowance.

Maximum Output Voltage Range

When the supply voltage does not meet the condition of electrical characteristics, the range of the typ. value of the maximum output voltage is as follows:

$$V_{OM} (typ.) = V^- + 0.2V \text{ to } V^+ - 1.0V \text{ (R}_L = 1k\Omega \text{ to } V^+/2, \text{ Ta} = 25^\circ\text{C)}$$

During designing, consider variations in characteristics and temperature characteristics for use with allowance.

In addition, also note that the output voltage range becomes narrow as shown in typical characteristics graph when an output current increases.

Terminating unused Op-Amps

Figure 2 shows examples of common method of terminating uncommitted operational amplifiers with using dual or quad. Improper termination can be result increase supply current, heating and noise in Op-Amps.

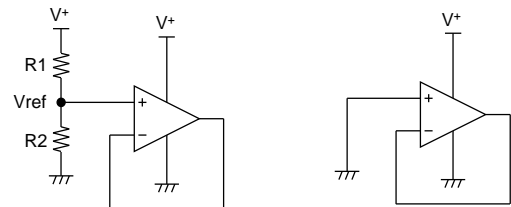
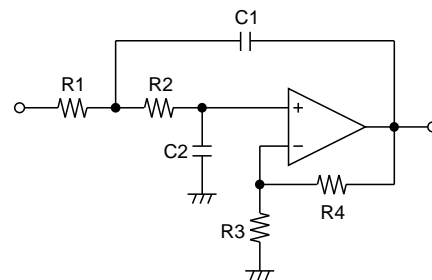

Figure 2. Terminating unused Op-Amps

Sallen-Key 2nd-Order Active Low-Pass Filter

The Sallen-Key 2nd-order active low-pass filter is shown in Figure 3. It can be used for a multiple pole filter required high attenuation.



$$R = R1 = R2, C = C1 = C2$$

Q: Quality factor, G<sub>DC</sub>: DC Gain

$$f_{.3dB} = \frac{1}{2\pi RC}, Q = \frac{1}{3 - G_{DC}}, G_{DC} = 1 + \frac{R4}{R3} = 3 - \frac{1}{Q}$$

Figure 3. Sallen-Key 2nd-Order Low-Pass Filter

■ TYPICAL CHARACTERISTICS

Note: Typical Characteristics are intended to be used as reference data; they are not guaranteed.

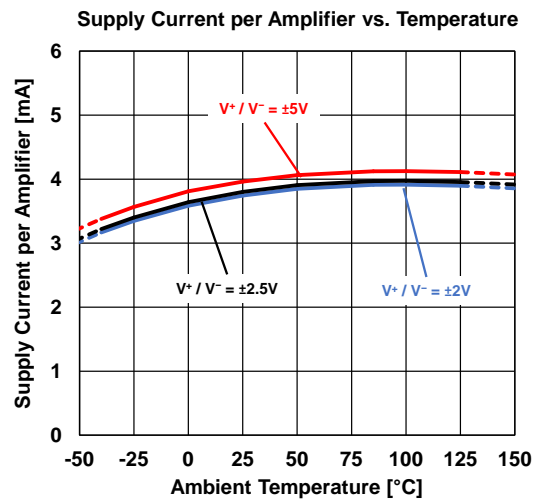
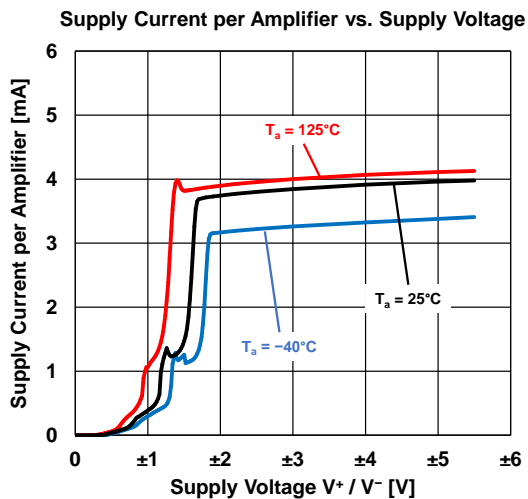
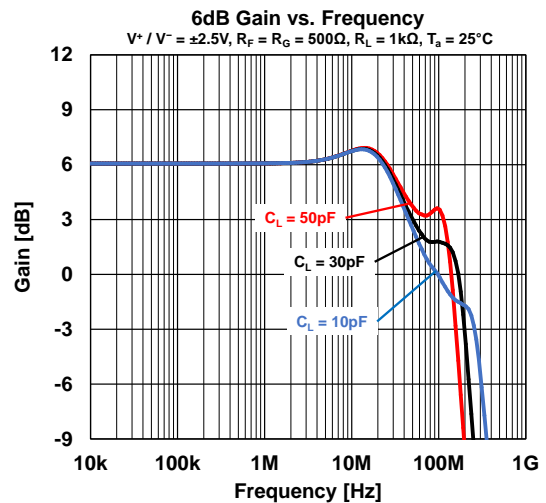
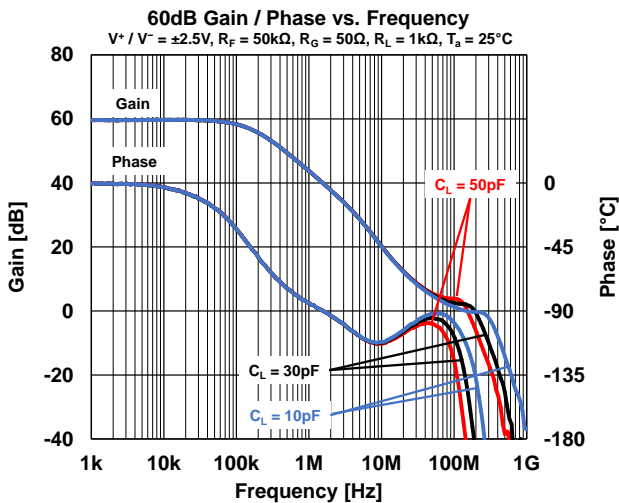
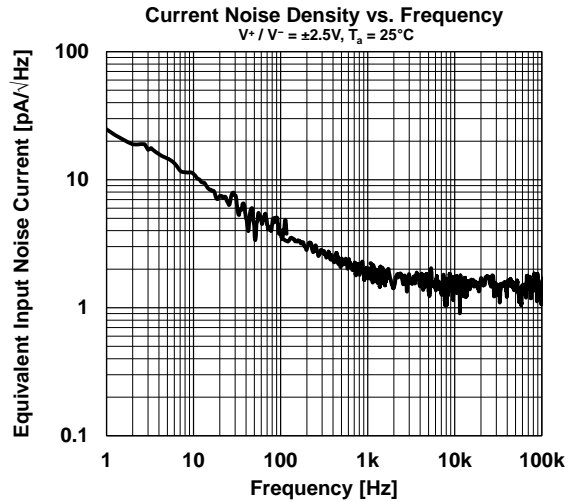
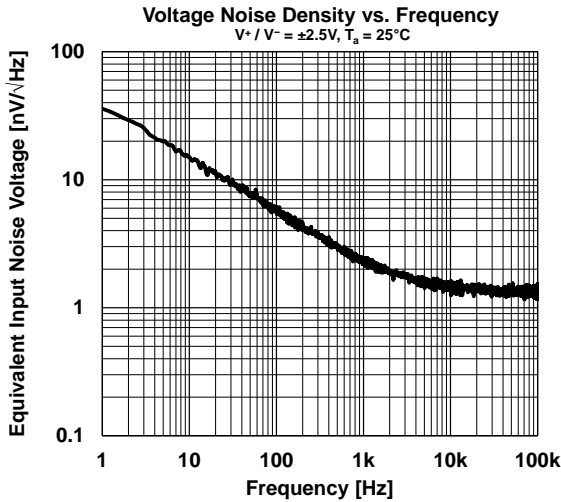



■ TYPICAL CHARACTERISTICS

Note: Typical Characteristics are intended to be used as reference data; they are not guaranteed.

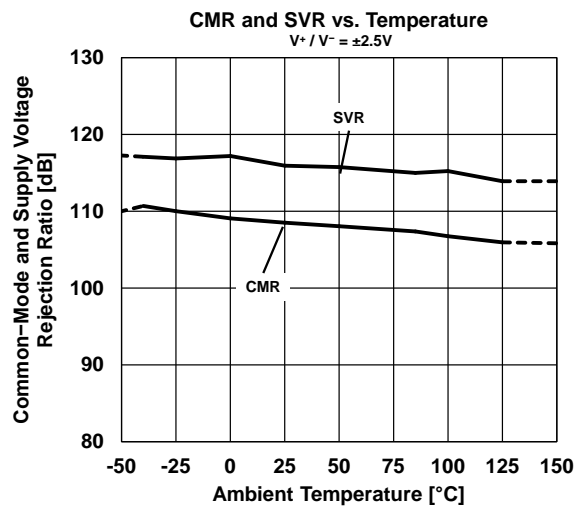
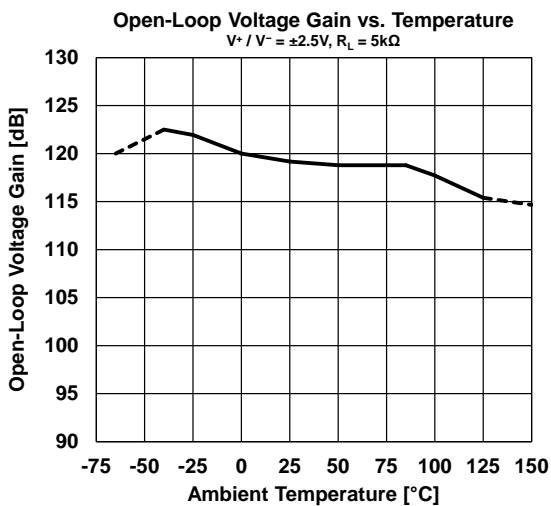
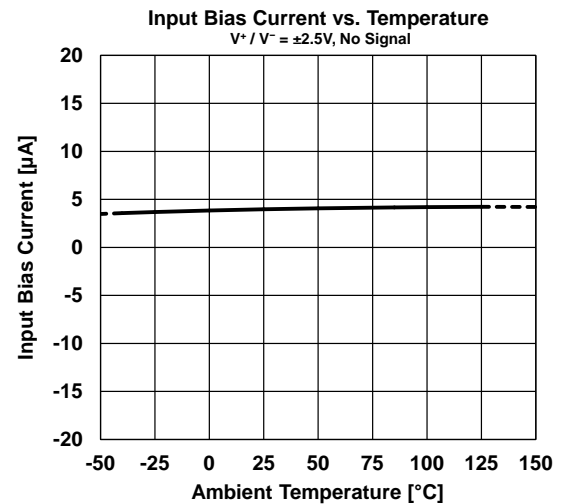
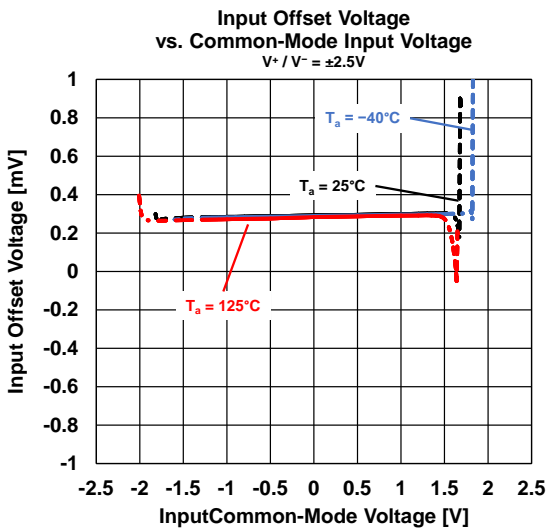
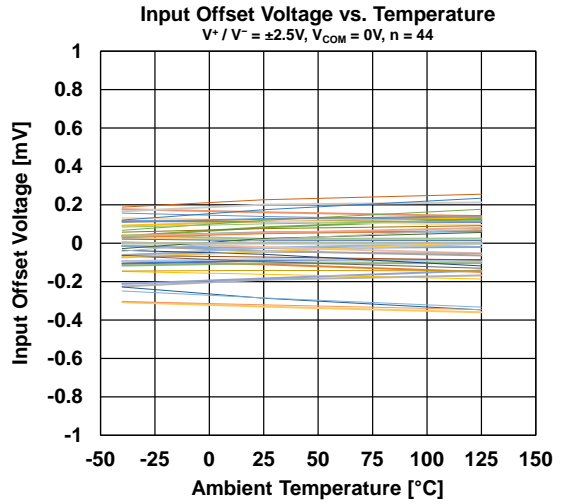
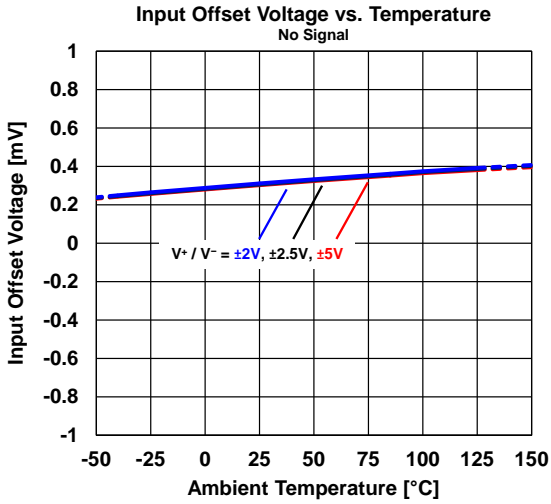

■ TYPICAL CHARACTERISTICS

Note: Typical Characteristics are intended to be used as reference data; they are not guaranteed.

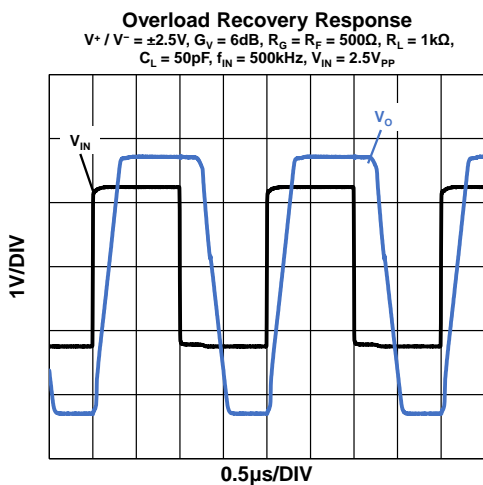
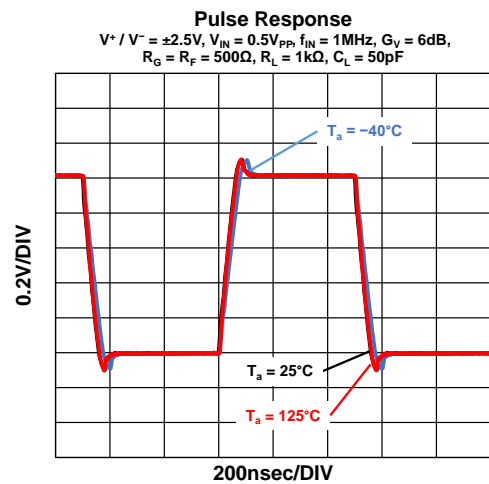
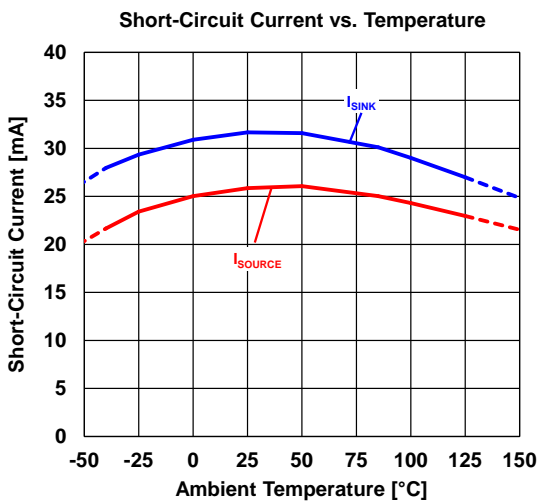
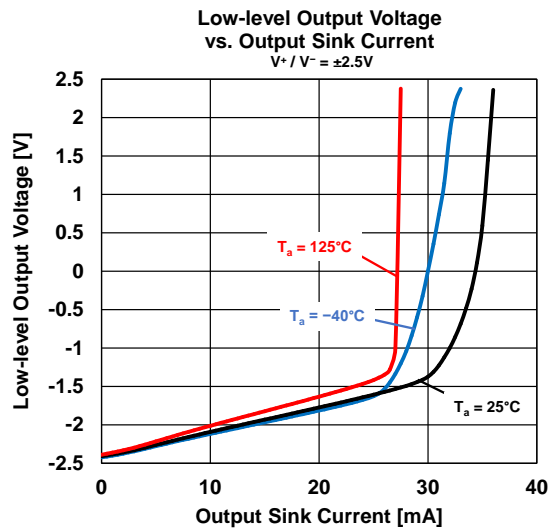
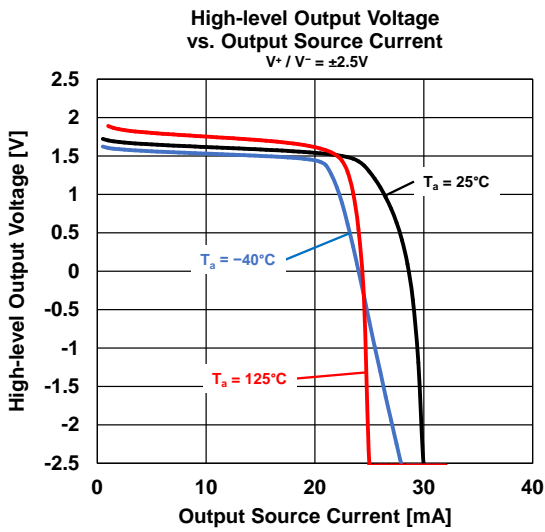

■ TEST CIRCUITS

● I<sub>SUPPLY</sub>

R<sub>G</sub>=500Ω, R<sub>F</sub>=500Ω

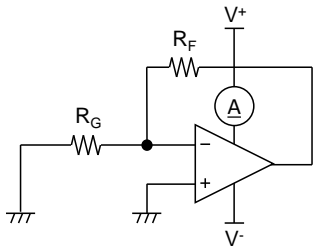

● V<sub>IO</sub>, CMR, SVR

R<sub>G</sub>=50Ω, R<sub>F</sub>=50kΩ

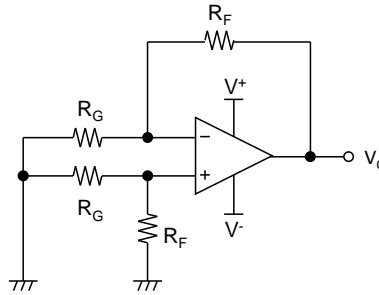

$$V_{IO} = \frac{R_G}{(R_G + R_F)} \times V_O$$

$$CMR = 20 \log \frac{\Delta V_{COM} \left(1 + \frac{R_F}{R_G}\right)}{\Delta V_O}$$

$$SVR = 20 \log \frac{\Delta V_s \left(1 + \frac{R_F}{R_G}\right)}{\Delta V_O}$$

$$V_s = V^+ - V^-$$

● V<sub>OH</sub>, V<sub>OL</sub>

V<sub>OH</sub>: V<sub>in+</sub> = 0.1V, V<sub>in-</sub> = 0V  
V<sub>OL</sub>: V<sub>in+</sub> = -0.1V, V<sub>in-</sub> = 0V

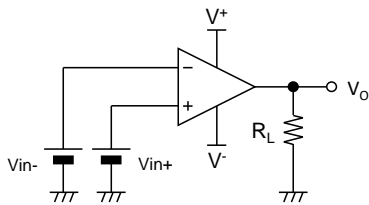

● GBW

R<sub>G</sub>=50Ω, R<sub>F</sub>=50kΩ, C<sub>L</sub>=50pF

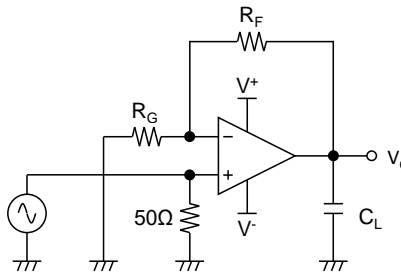

● SR

R<sub>G</sub>=50Ω, R<sub>F</sub>=50kΩ, R<sub>L</sub>=1kΩ, C<sub>L</sub>=50pF

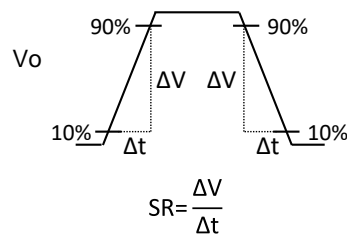
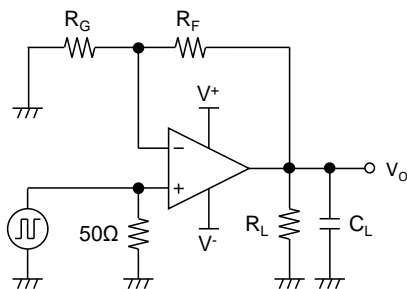

■ REVISION HISTORY

Date	Revision	Changes
May 10, 2022	Ver.1.0	Initial Release
August 25, 2022	Ver.1.1	Corrected unit of Input Offset Voltage vs. Temperature characteristics.

# Nisshinbo Micro Devices Inc.

MSOP8 (VSP8)

PI-VSP8-E-A

■ PACKAGE DIMENSIONS

UNIT: mm

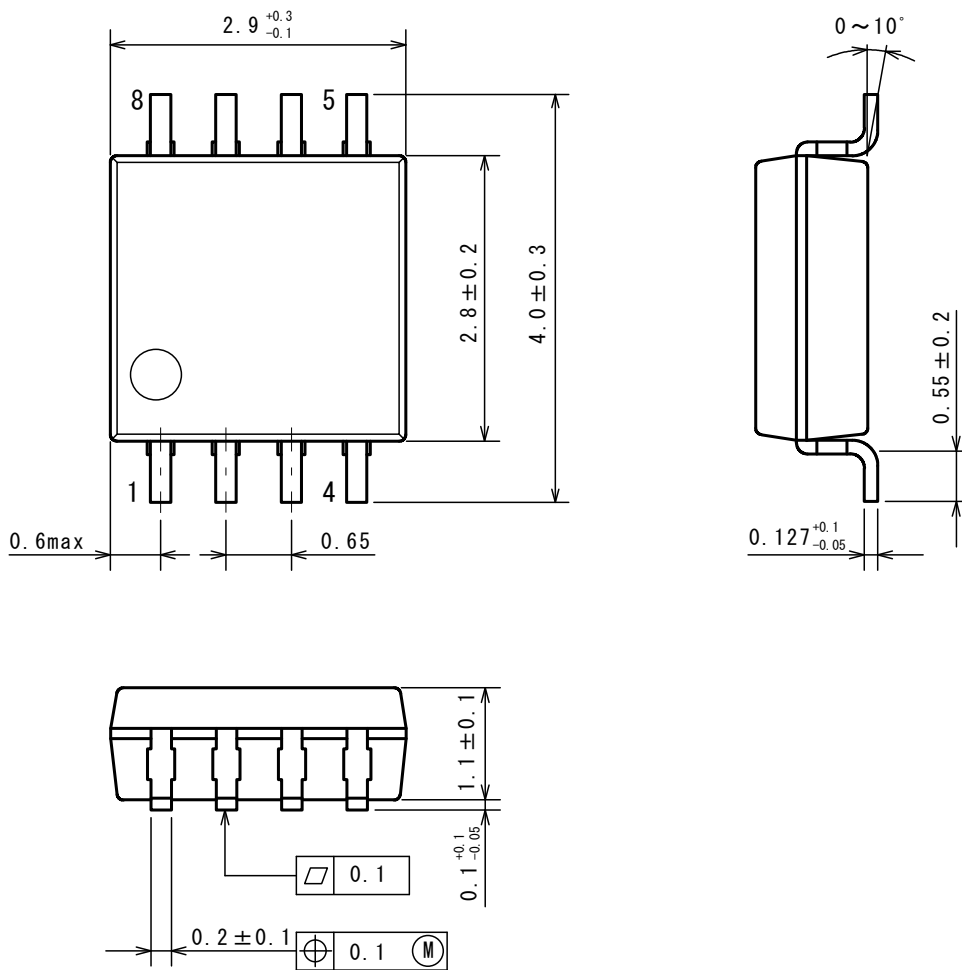

**Nisshinbo Micro Devices Inc.**

MSOP8 (VSP8)

PI-VSP8-E-A

## ■ EXAMPLE OF SOLDER PADS DIMENSIONS

UNIT: mm

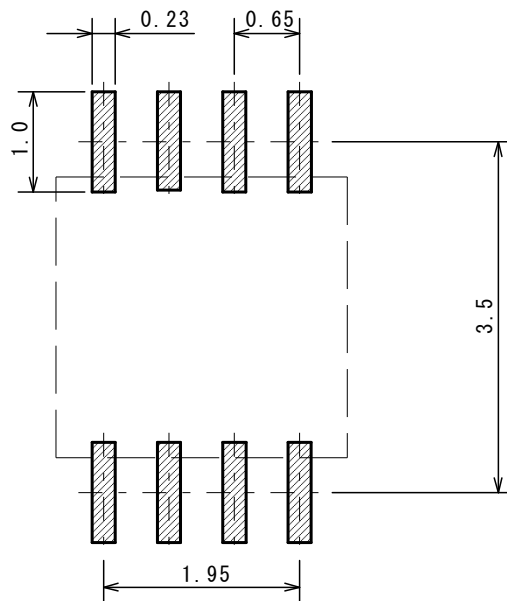

# Nisshinbo Micro Devices Inc.

## MSOP8 (VSP8)

PI-VSP8-E-A

### PACKING SPEC

UNIT: mm

#### TAPING DIMENSIONS

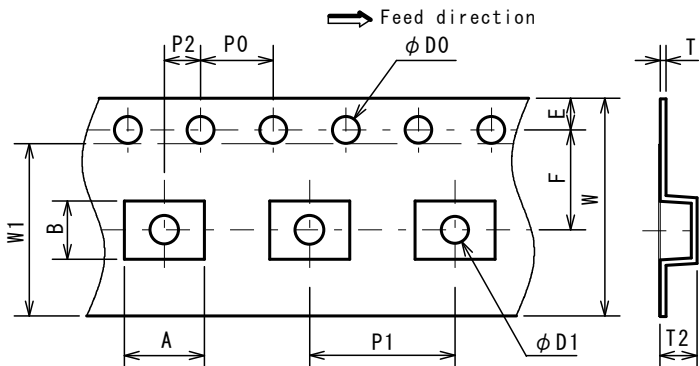

SYMBOL	DIMENSION	REMARKS
A	4.4	BOTTOM DIMENSION
B	3.2	BOTTOM DIMENSION
D0	1.5 <sup>+0.1</sup> <sub>0</sub>	
D1	1.5 <sup>+0.1</sup> <sub>0</sub>	
E	1.75±0.1	
F	5.5±0.05	
P0	4.0±0.1	
P1	8.0±0.1	
P2	2.0±0.05	
T	0.30±0.05	
T2	2.0 (MAX.)	
W	12.0±0.3	
W1	9.5	THICKNESS 0.1max

#### REEL DIMENSIONS

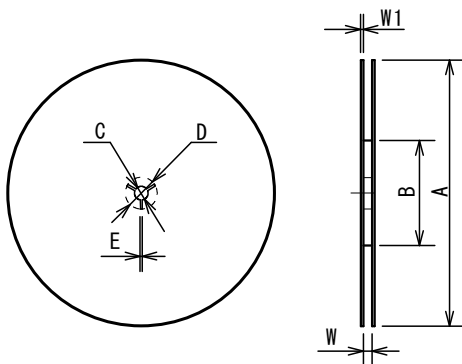

SYMBOL	DIMENSION
A	φ 254±2
B	φ 100±1
C	φ 13±0.2
D	φ 21±0.8
E	2±0.5
W	13.5±0.5
W1	2.0±0.2

#### TAPING STATE

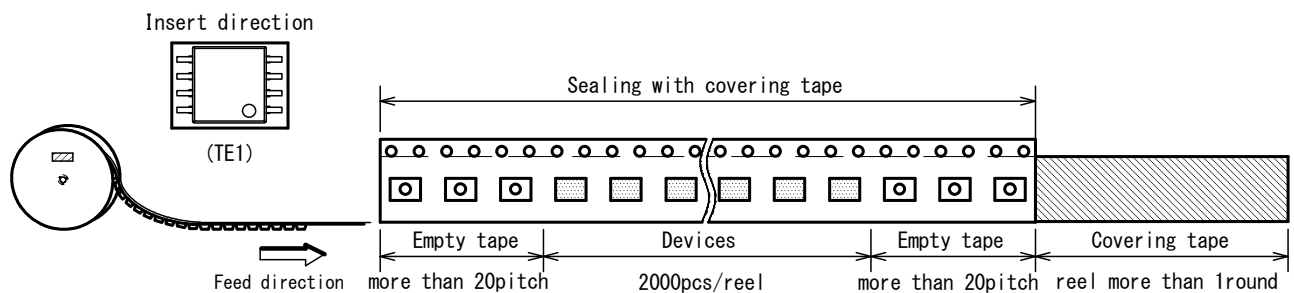

#### PACKING STATE

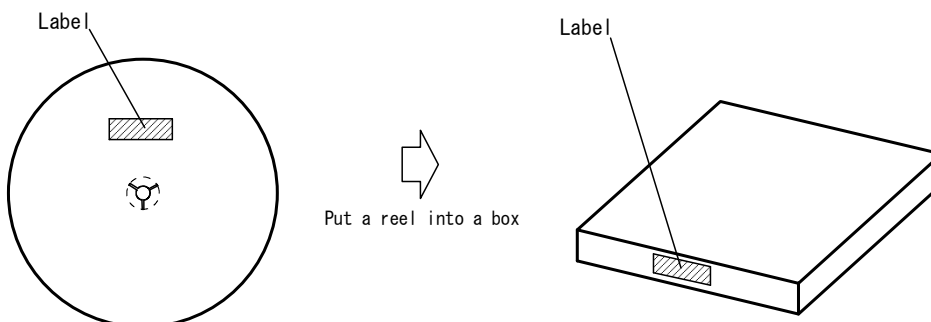

■ PACKAGE DIMENSIONS

UNIT: mm

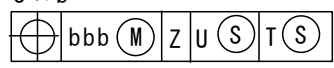
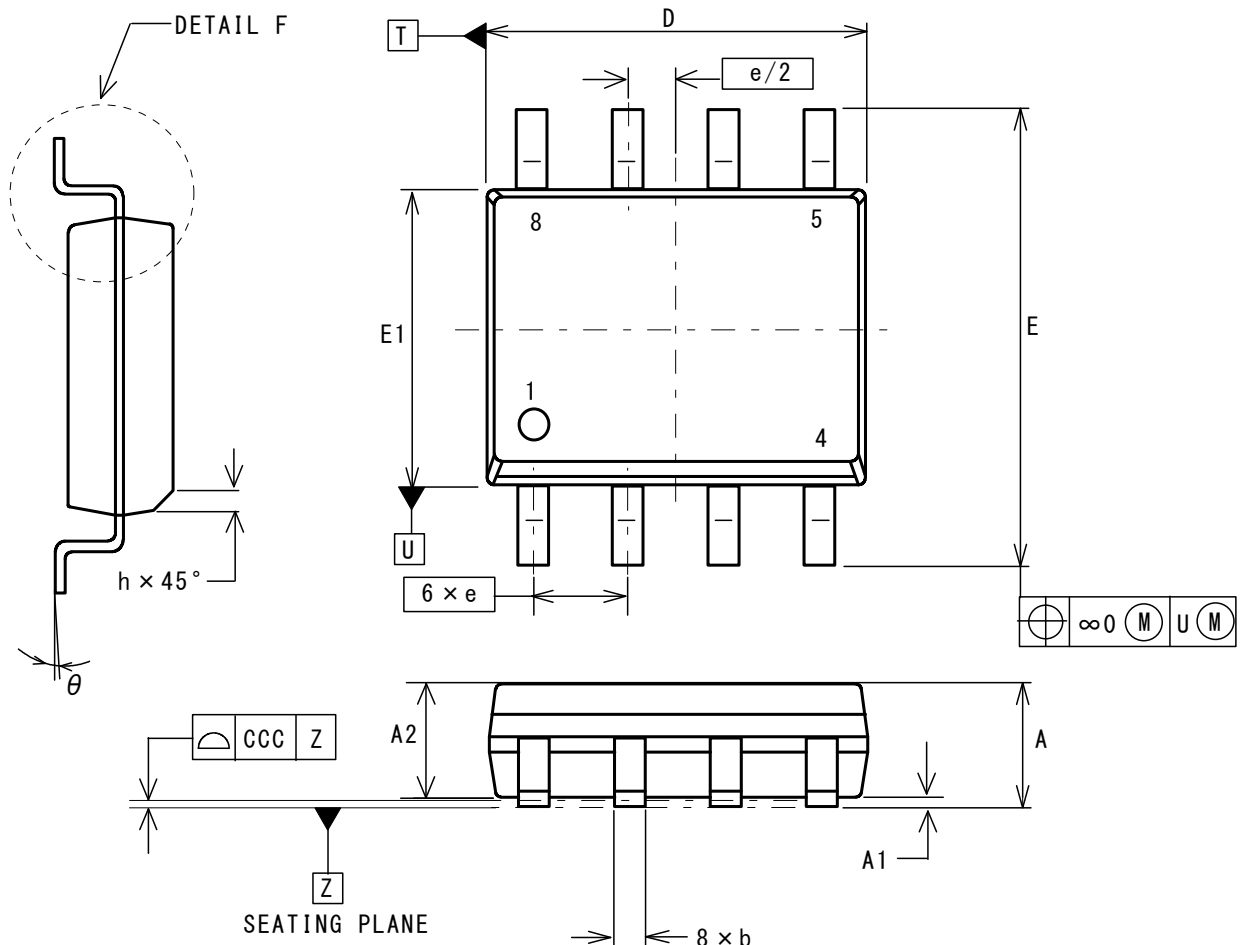

DESCRIPTION	SYMBOL	INCH			MILLIMETER		
		MIN	NCM	MAX	MIN	NCM	MAX
TOTAL THICKNESS	A	.053		.069	1.35		1.75
STAND OFF	A <sub>1</sub>	.004		.010	0.10		0.25
MOLD THICKNESS	A <sub>2</sub>	.049		-	1.25		-
LEAD WIDTH	b	.014		.019	0.35		0.49
L/F THICKNESS	C	.007		.010	0.19		0.25
BODY SIZE	D	.189		.197	4.80		5.00
	E <sub>1</sub>	.150		.157	3.80		4.00
LEAD PITCH	E	.228		.244	5.80		6.20
	e	.050 BSC			1.27 BSC		
	L	.015		.049	0.40		1.25
	h	.010		.020	0.25		0.50
	θ	0°		8°	0°		7°
	θ <sub>1</sub>	5°		15°	5°		15°
	θ <sub>2</sub>	2°	7°	12°	2°	7°	12°
LEAD EDGE OFFSET	∞0	.010			0.25		
LEAD OFFSET	bbb	.010			0.25		
COPLANARITY	CCC	.004			0.10		

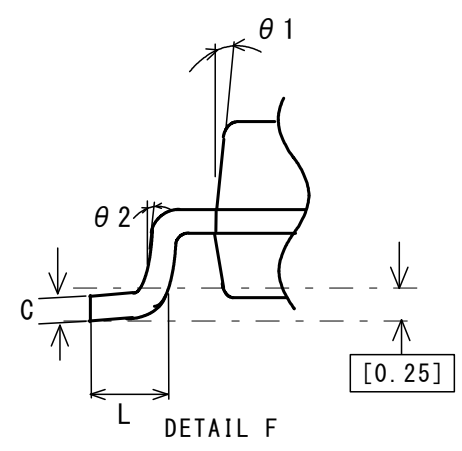



## ■ EXAMPLE OF SOLDER PADS DIMENSIONS

UNIT: mm

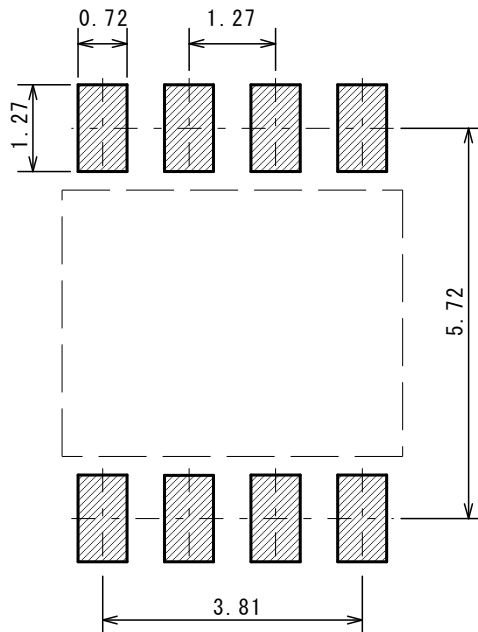

# Nisshinbo Micro Devices Inc.

SOP8

PI-SOP8-E-A

■ PACKING SPEC

UNIT: mm

REEL DIMENSIONS / TAPING DIMENSIONS

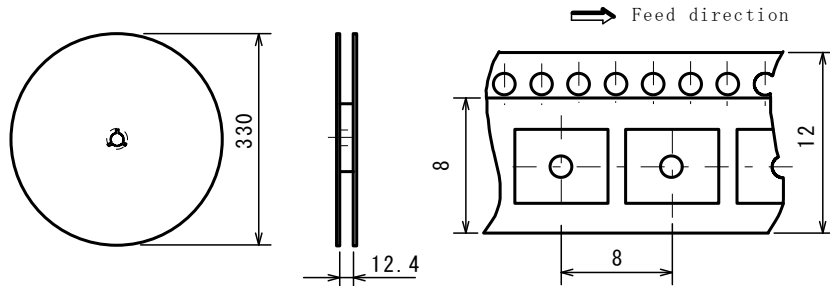

TAPING STATE

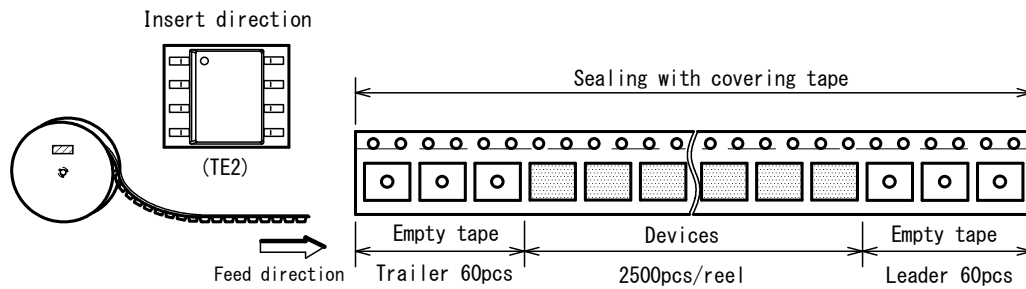

PACKING STATE

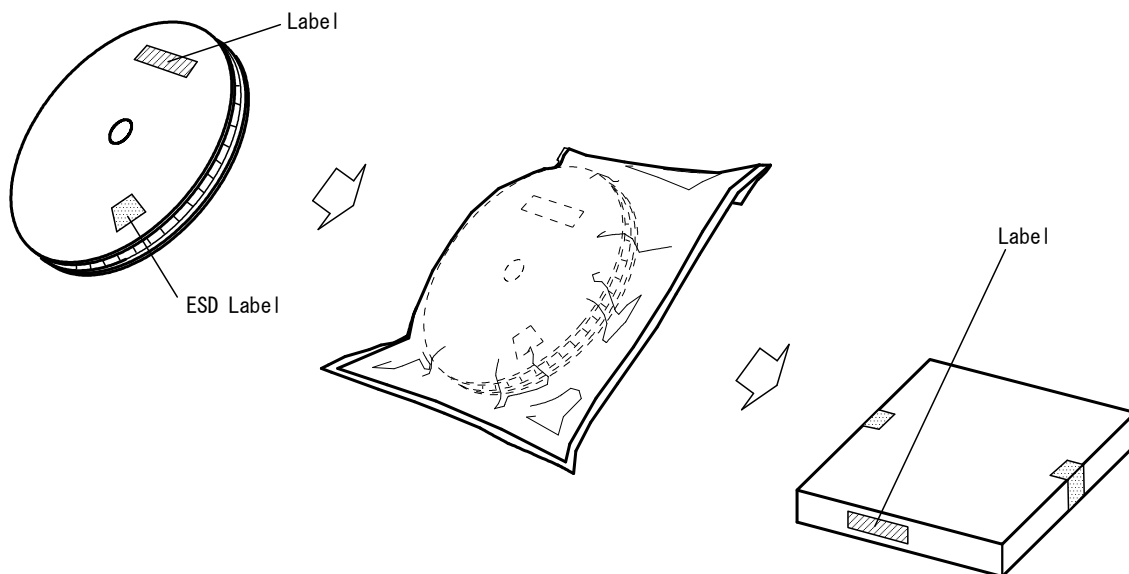

1. The products and the product specifications described in this document are subject to change or discontinuation of production without notice for reasons such as improvement. Therefore, before deciding to use the products, please refer to our sales representatives for the latest information thereon.
2. The materials in this document may not be copied or otherwise reproduced in whole or in part without the prior written consent of us.
3. This product and any technical information relating thereto are subject to complementary export controls (so-called KNOW controls) under the Foreign Exchange and Foreign Trade Law, and related politics ministerial ordinance of the law. (Note that the complementary export controls are inapplicable to any application-specific products, except rockets and pilotless aircraft, that are insusceptible to design or program changes.) Accordingly, when exporting or carrying abroad this product, follow the Foreign Exchange and Foreign Trade Control Law and its related regulations with respect to the complementary export controls.
4. The technical information described in this document shows typical characteristics and example application circuits for the products. The release of such information is not to be construed as a warranty of or a grant of license under our or any third party's intellectual property rights or any other rights.
5. The products listed in this document are intended and designed for use as general electronic components in standard applications (office equipment, telecommunication equipment, measuring instruments, consumer electronic products, amusement equipment etc.). Those customers intending to use a product in an application requiring extreme quality and reliability, for example, in a highly specific application where the failure or misoperation of the product could result in human injury or death should first contact us.
  - Aerospace Equipment
  - Equipment Used in the Deep Sea
  - Power Generator Control Equipment (nuclear, steam, hydraulic, etc.)
  - Life Maintenance Medical Equipment
  - Fire Alarms / Intruder Detectors
  - Vehicle Control Equipment (automotive, airplane, railroad, ship, etc.)
  - Various Safety Devices
  - Traffic control system
  - Combustion equipment

In case your company desires to use this product for any applications other than general electronic equipment mentioned above, make sure to contact our company in advance. Note that the important requirements mentioned in this section are not applicable to cases where operation requirements such as application conditions are confirmed by our company in writing after consultation with your company.

6. We are making our continuous effort to improve the quality and reliability of our products, but semiconductor products are likely to fail with certain probability. In order to prevent any injury to persons or damages to property resulting from such failure, customers should be careful enough to incorporate safety measures in their design, such as redundancy feature, fire containment feature and fail-safe feature. We do not assume any liability or responsibility for any loss or damage arising from misuse or inappropriate use of the products.
7. The products have been designed and tested to function within controlled environmental conditions. Do not use products under conditions that deviate from methods or applications specified in this datasheet. Failure to employ the products in the proper applications can lead to deterioration, destruction or failure of the products. We shall not be responsible for any bodily injury, fires or accident, property damage or any consequential damages resulting from misuse or misapplication of the products.
8. **Quality Warranty**
  - 8-1. **Quality Warranty Period**

In the case of a product purchased through an authorized distributor or directly from us, the warranty period for this product shall be one (1) year after delivery to your company. For defective products that occurred during this period, we will take the quality warranty measures described in section 8-2. However, if there is an agreement on the warranty period in the basic transaction agreement, quality assurance agreement, delivery specifications, etc., it shall be followed.
  - 8-2. **Quality Warranty Remedies**

When it has been proved defective due to manufacturing factors as a result of defect analysis by us, we will either deliver a substitute for the defective product or refund the purchase price of the defective product.

Note that such delivery or refund is sole and exclusive remedies to your company for the defective product.
  - 8-3. **Remedies after Quality Warranty Period**

With respect to any defect of this product found after the quality warranty period, the defect will be analyzed by us. On the basis of the defect analysis results, the scope and amounts of damage shall be determined by mutual agreement of both parties. Then we will deal with upper limit in Section 8-2. This provision is not intended to limit any legal rights of your company.
9. Anti-radiation design is not implemented in the products described in this document.
10. The X-ray exposure can influence functions and characteristics of the products. Confirm the product functions and characteristics in the evaluation stage.
11. WLCSP products should be used in light shielded environments. The light exposure can influence functions and characteristics of the products under operation or storage.
12. Warning for handling Gallium and Arsenic (GaAs) products (Applying to GaAs MMIC, Photo Reflector). These products use Gallium (Ga) and Arsenic (As) which are specified as poisonous chemicals by law. For the prevention of a hazard, do not burn, destroy, or process chemically to make them as gas or power. When the product is disposed of, please follow the related regulation and do not mix this with general industrial waste or household waste.
13. Please contact our sales representatives should you have any questions or comments concerning the products or the technical information.



**Nisshinbo Micro Devices Inc.**

**Official website**

<https://www.nisshinbo-microdevices.co.jp/en/>

**Purchase information**

<https://www.nisshinbo-microdevices.co.jp/en/buy/>