

SP3T SWITCH GaAs MMIC

GENERAL DESCRIPTION

The NJG1808K94 is a low power SP3T switch controlled by two bits signals. The low loss performance and high Isolation makes the switch MMIC ideal choice for receiving application.

The NJG1808K94 SP3T switch is provided in a ultra small 9-pin QFN9-94 package with integrated DC blocking capacitor at PC port.

PACKAGE OUTLINE

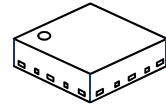

NJG1808K94

APPLICATIONS

- LTE,3G and 2G Multi-mode applications
- Pre PA switching, reception bands and LTE diversity antenna switching applications
- General purpose switching applications

FEATURES

- Low voltage logic control $V_{CTL(H)}=1.35V$ to 4.5V
- Low insertion loss
 - 0.35dB typ. @f=1.0GHz, $P_{IN}=0dBm$
 - 0.40dB typ. @f=2.0GHz, $P_{IN}=0dBm$
 - 0.40dB typ. @f=2.7GHz, $P_{IN}=0dBm$
- High isolation
 - 29dB typ. @f=1.0GHz, $P_{IN}=0dBm$
 - 26dB typ. @f=2.0GHz, $P_{IN}=0dBm$
 - 24dB typ. @f=2.7GHz, $P_{IN}=0dBm$
- $P_{-0.2dB}$
 - 22dBm typ. @f=2.0GHz
- Ultra small & thin package QFN9-94 (Package size: 1.1 x 1.1 x 0.425mm typ.)
- RoHS compliant and Halogen Free, MSL1

PIN CONFIGURATION

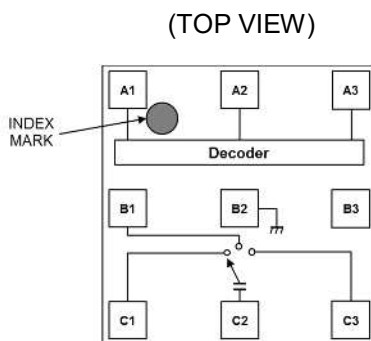

- Pin connection
- A1. VCTL1
 - A2. VCTL2
 - A3. VDD
 - B1. P3
 - B2. NC(GND)
 - B3. GND
 - C1. P1
 - C2. PC
 - C3. P2

TRUTH TABLE

“H”= $V_{CTL(H)}$, “L”= $V_{CTL(L)}$

VCTL1	VCTL2	PATH
H	L	PC-P1
L	H	PC-P2
H	H	PC-P3

NOTE: Please note that any information on this datasheet will be subject to change.

■ ABSOLUTE MAXIMUM RATINGS

(T_a=+25°C, Z_s=Z_i=50Ω)

PARAMETER	SYMBOL	CONDITIONS	RATINGS	UNITS
RF Input Power	P _{IN}	V _{DD} =2.7V	28	dBm
Supply Voltage	V _{DD}	VDD terminal	5.0	V
Control Voltage	V _{CTL}	VCTL1,VCTL2	5.0	V
Power Dissipation	P _D	Four-layer FR4 PCB (114.3x76.2mm, without through-hole) T _j =150°C	310	mW
Operating Temperature	T _{opr}		-40 to +105	°C
Storage Temperature	T _{stg}		-55 to +150	°C

■ ELECTRICAL CHARACTERISTICS1 (DC CHARACTERISTICS)

(General conditions: $T_a=+25^{\circ}\text{C}$, $V_{DD}=2.7\text{V}$, $V_{CTL(L)}=0\text{V}$, $V_{CTL(H)}=1.8\text{V}$, with application circuit)

PARAMETERS	SYMBOL	CONDITIONS	MIN	TYP	MAX	UNITS
Supply Voltage	V_{DD}	VDD terminal	1.5	2.7	4.5	V
Operating Current	I_{DD}		-	30	60	μA
Control Voltage (LOW)	$V_{CTL(L)}$	VCTL1,VCTL2	0	-	0.45	V
Control Voltage (HIGH)	$V_{CTL(H)}$	VCTL1,VCTL2	1.35	1.8	4.5	V
Control Current	I_{CTL}	$V_{CTL(H)} = 1.8\text{V}$	-	5	10	μA

■ ELECTRICAL CHARACTERISTICS2 (RF CHARACTERISTICS)

(General conditions: $T_a=+25^{\circ}\text{C}$, $Z_s=Z_l=50\Omega$, $V_{DD}=2.7\text{V}$, $V_{CTL(L)}=0\text{V}$, $V_{CTL(H)}=1.8\text{V}$, with application circuit)

PARAMETERS	SYMBOL	CONDITIONS	MIN	TYP	MAX	UNITS
Insertion Loss 1	LOSS1	$f=0.7\text{GHz}$, $P_{IN}=0\text{dBm}$	-	0.35	0.55	dB
Insertion Loss 2	LOSS2	$f=1.0\text{GHz}$, $P_{IN}=0\text{dBm}$	-	0.35	0.55	dB
Insertion Loss 3	LOSS3	$f=2.0\text{GHz}$, $P_{IN}=0\text{dBm}$	-	0.40	0.60	dB
Insertion Loss 4	LOSS4	$f=2.7\text{GHz}$, $P_{IN}=0\text{dBm}$	-	0.40	0.60	dB
Isolation 1	ISL1	PC-P1, P2, P3 $f=0.7\text{GHz}$, $P_{IN}=0\text{dBm}$	27	30	-	dB
Isolation 2	ISL2	PC-P1, P2, P3 $f=1.0\text{GHz}$, $P_{IN}=0\text{dBm}$	26	29	-	dB
Isolation 3	ISL3	PC-P1, P2, P3 $f=2.0\text{GHz}$, $P_{IN}=0\text{dBm}$	23	26	-	dB
Isolation 4	ISL4	PC-P1, P2, P3 $f=2.7\text{GHz}$, $P_{IN}=0\text{dBm}$	21	24	-	dB
Input power at 0.2dB Compression Point	$P_{-0.2\text{dB}}$	$f=2.0\text{GHz}$	18	22	-	dBm
VSWR	VSWR	$f=2.0\text{GHz}$, On port	-	1.3	1.5	-
Switching time	T_{SW}	50% V_{CTL} to 10/90% RF	-	2	5	μs

■ TERMINAL INFORMATION

No.	SYMBOL	DESCRIPTION
A1	VCTL1	Control signal input terminal. This terminal is set to High-Level (+1.35 to +4.5V) or Low-Level (0 to +0.45V).
A2	VCTL2	Control signal input terminal. This terminal is set to High-Level (+1.35 to +4.5V) or Low-Level (0 to +0.45V).
A3	VDD	Positive voltage supply terminal. The positive voltage (+1.5 to +4.5V) has to be supplied. Please connect a bypass capacitor with GND terminal for excellent RF performance.
B1	P3	RF input / output port. External capacitor is required to block the DC bias voltage of internal circuit.
B2	NC(GND)	No connected terminal. This terminal is not connected with internal circuit. Please connect to the PCB ground plane.
B3	GND	Ground terminal. Please connect this terminal with ground plane as close as possible for excellent RF performance.
C1	P1	RF input / output port. External capacitor is required to block the DC bias voltage of internal circuit.
C2	PC	RF input/output port. No DC blocking capacitor is required for this port because of internal capacitor.
C3	P2	RF input / output port. External capacitor is required to block the DC bias voltage of internal circuit.

■ ELECTRICAL CHARACTERISTICS (With Application circuit, Loss of external circuit are excluded)

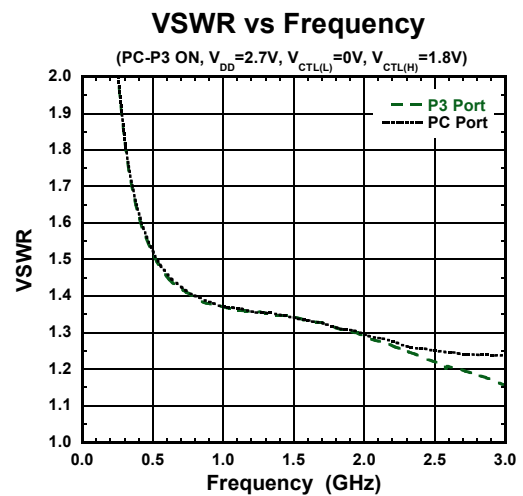
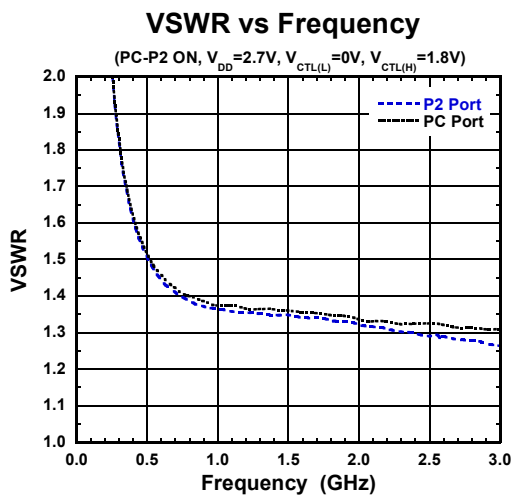
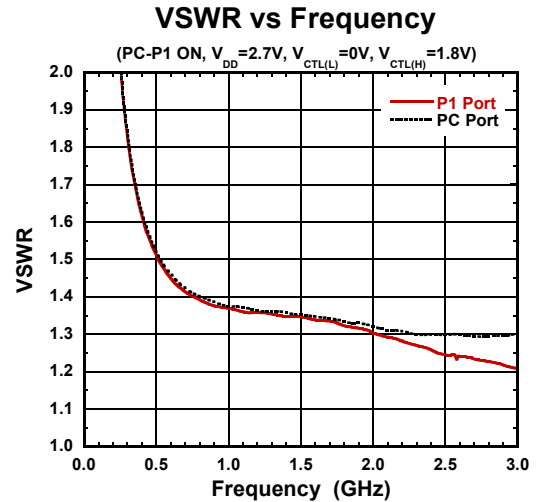
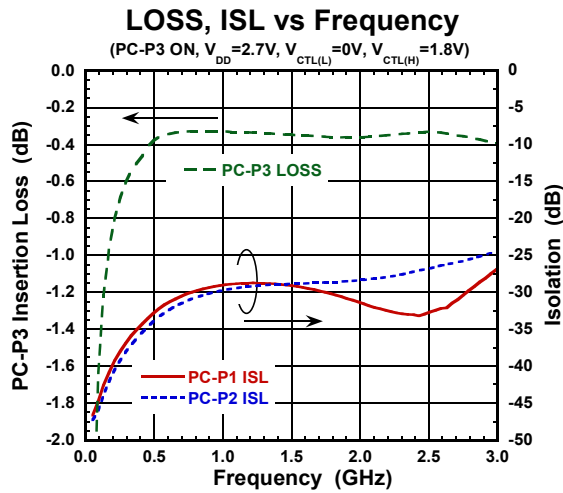
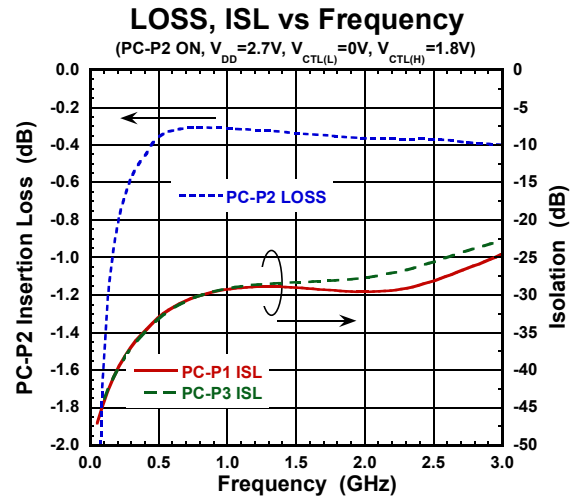
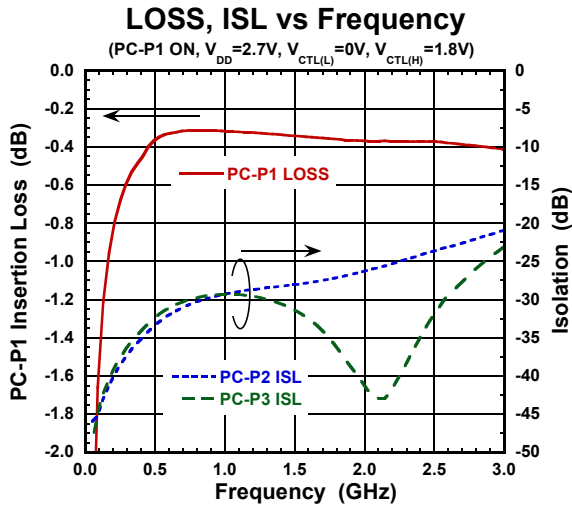

■ ELECTRICAL CHARACTERISTICS (With Application circuit, Loss of external circuit are excluded)

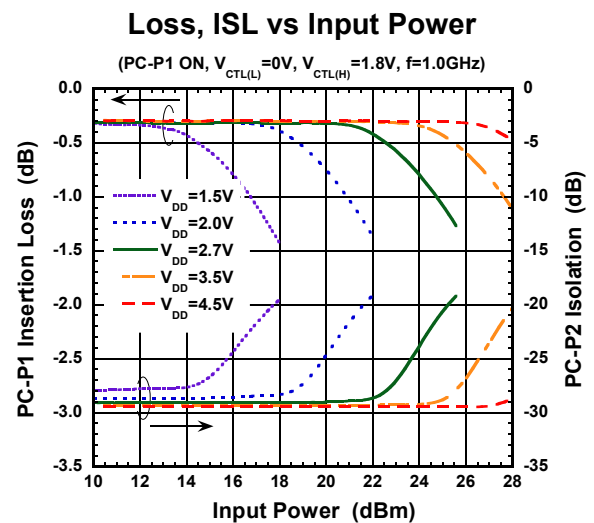
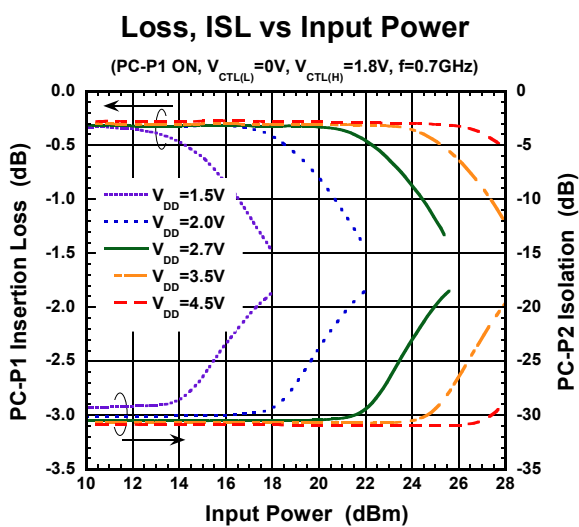
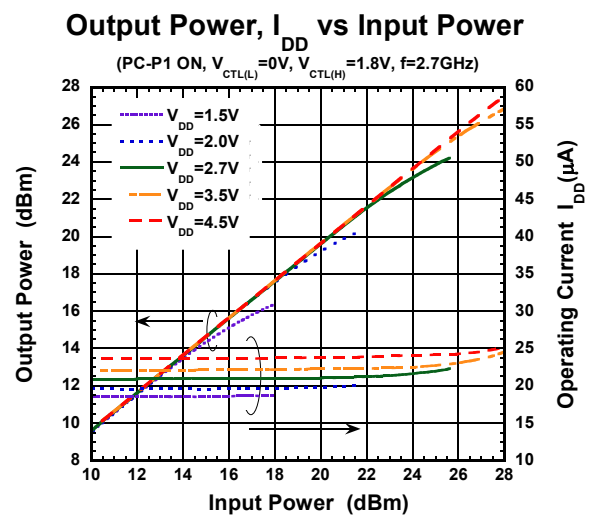
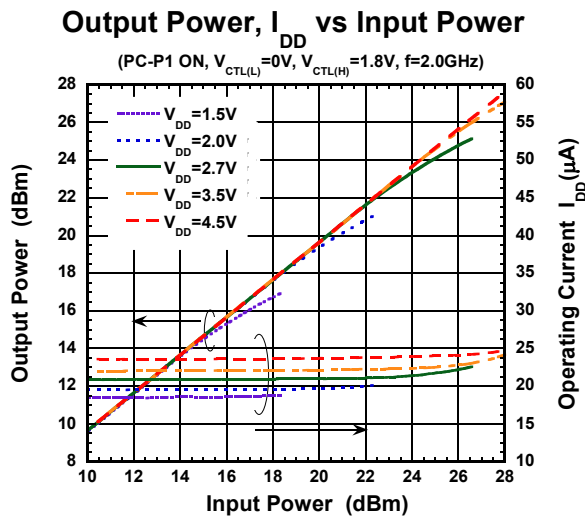
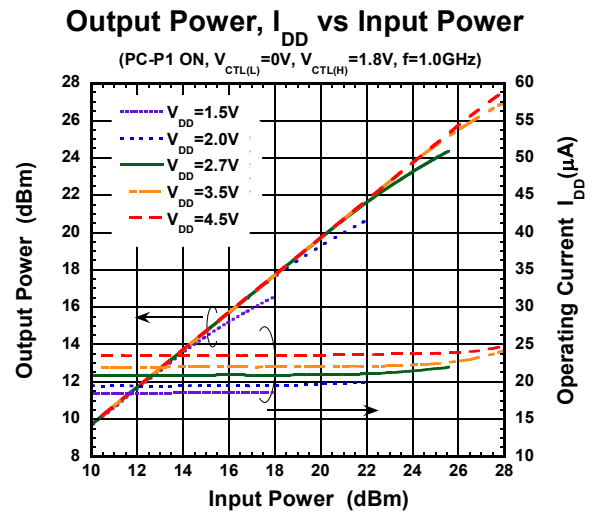
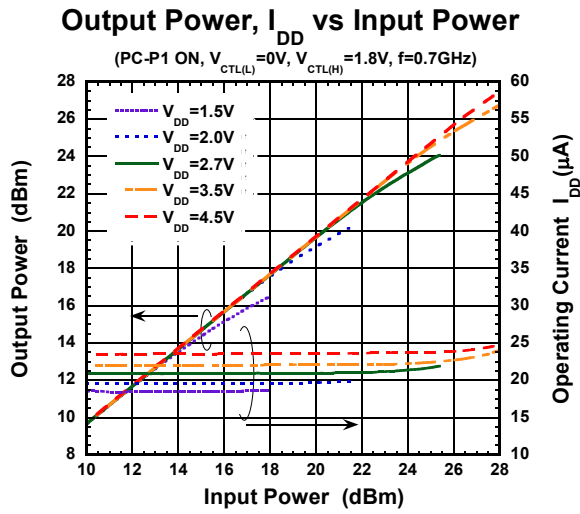

■ ELECTRICAL CHARACTERISTICS (With Application circuit, Loss of external circuit are excluded)

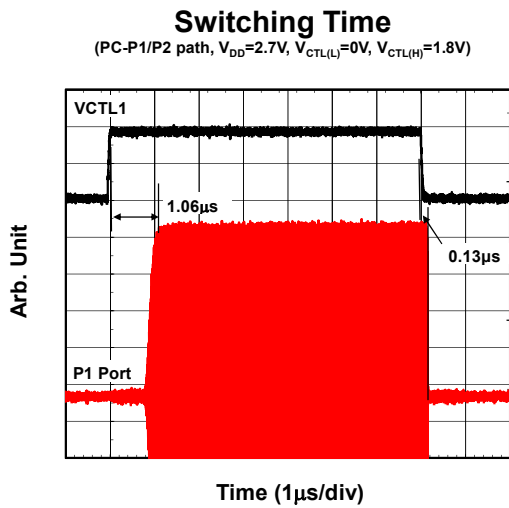
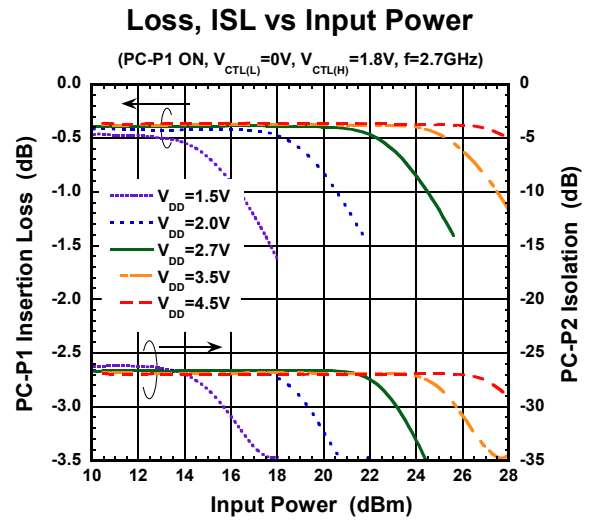
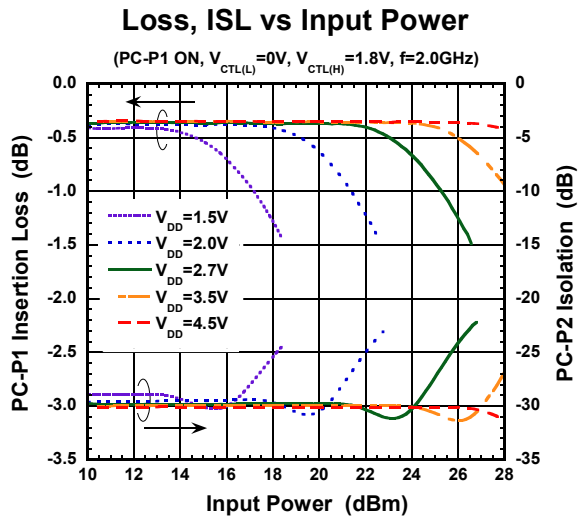

■ ELECTRICAL CHARACTERISTICS (With Application circuit, Loss of external circuit are excluded)

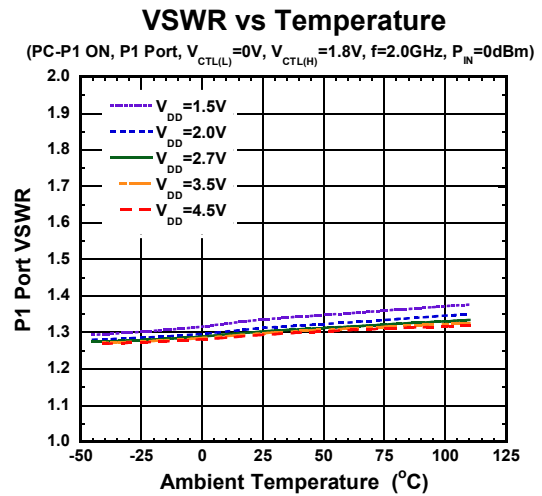
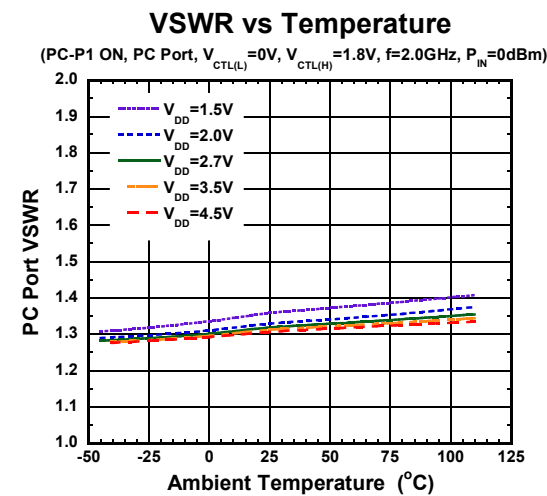
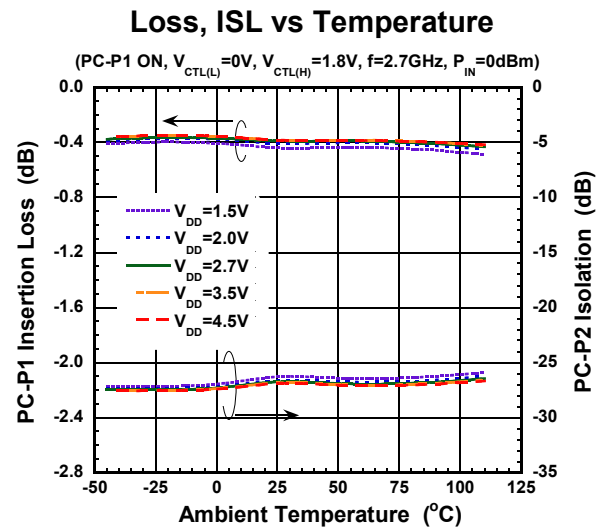
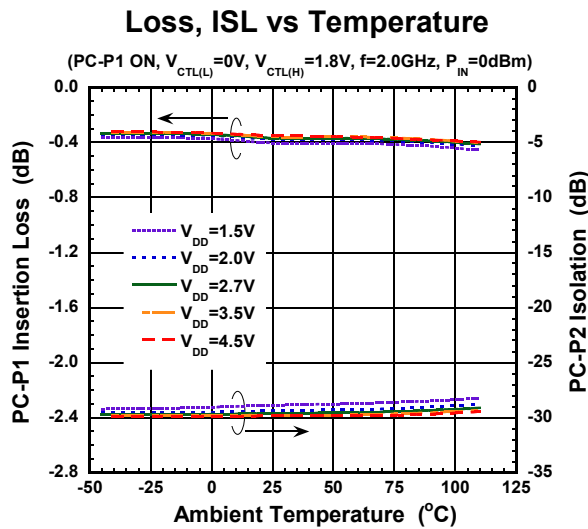
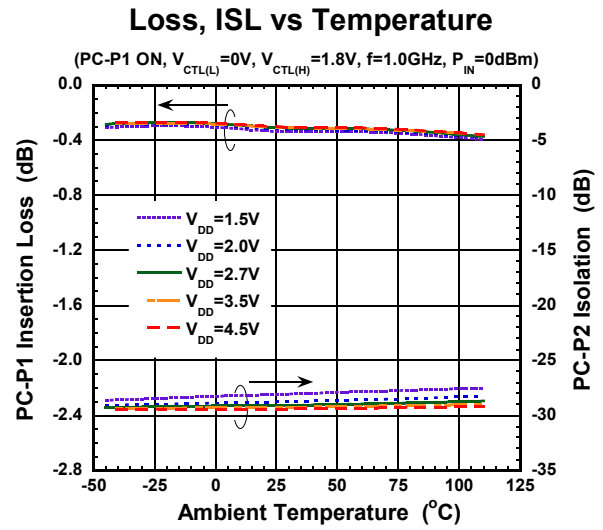
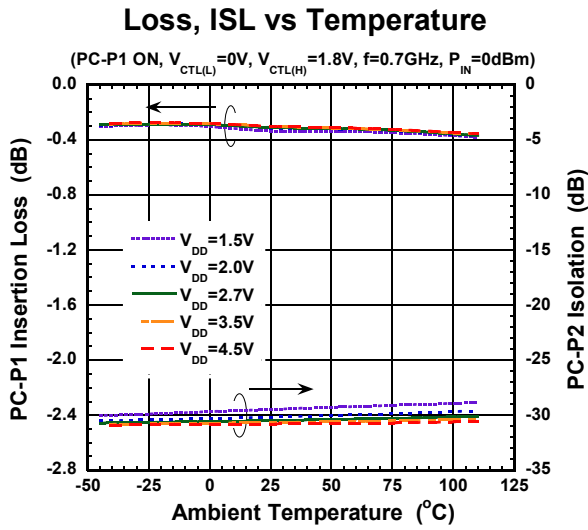

■ ELECTRICAL CHARACTERISTICS (With Application circuit, Loss of external circuit are excluded)

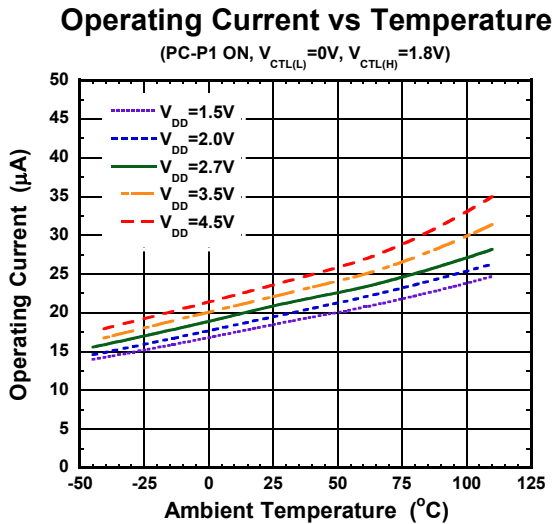
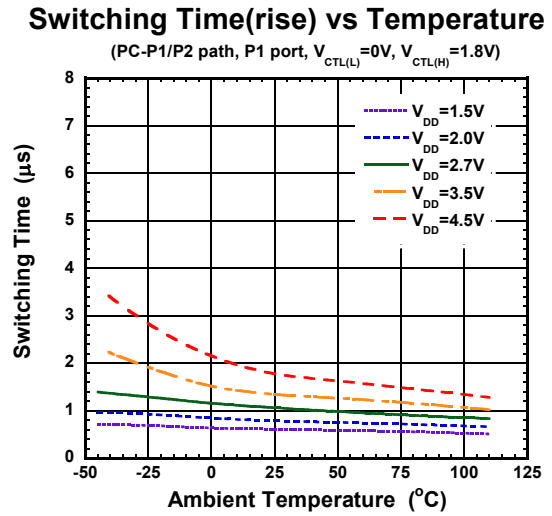
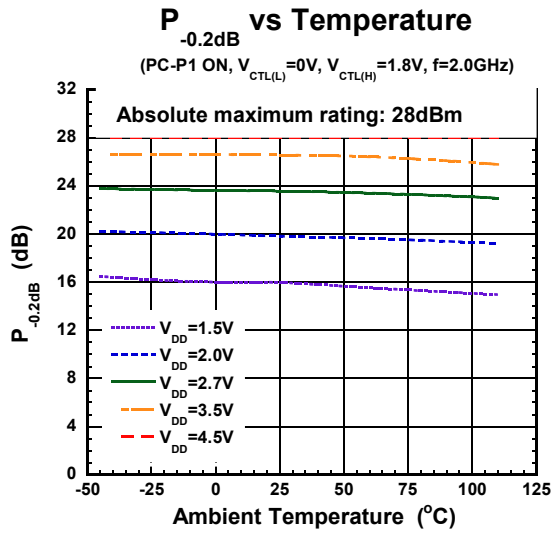

APPLICATION CIRCUIT

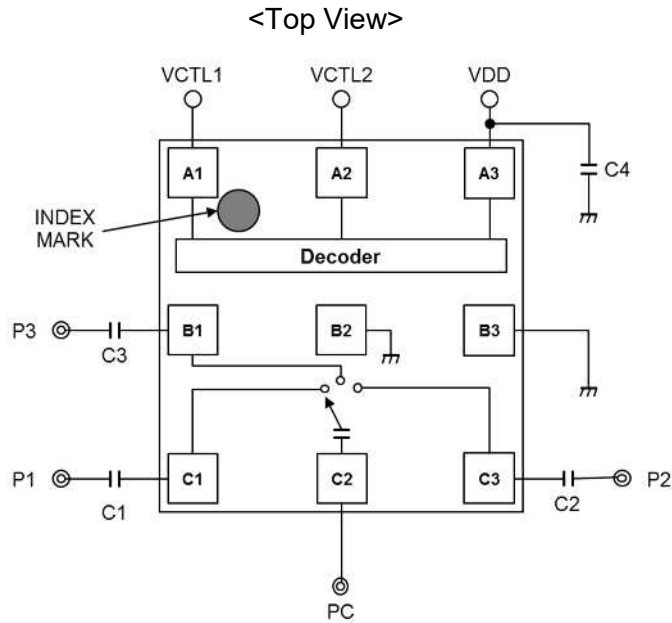

NOTE:

[1] The DC blocking capacitor is not necessary at PC Port because of the integrated DC blocking capacitor.

[2] The DC current at RF ports must be equal to zero, which can be achieved with DC blocking capacitors (C1, C2, and C3).

*However, in case there is no possibility that DC current flows, the DC blocking capacitors are unnecessary, i.e. the RF signals are fed by SAW filters that block DC current by nature, etc.

PARTS LIST

Part ID	Value	Notes
C1 to C3	56pF	MURATA (GRM15)
C4	1000pF	MURATA (GRM15)

RECOMMENDED PCB DESIGN

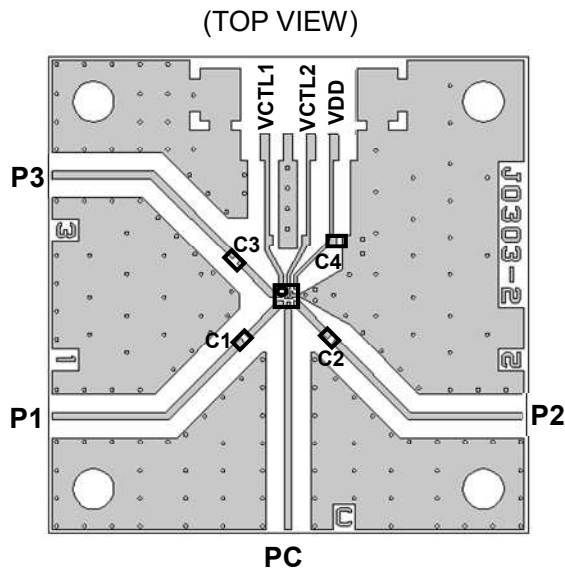

PCB: FR-4, t=0.2mm
 Capacitor Size: 1005(1.0x0.5mm)
 Strip Line Width: 0.38mm
 PCB Size: 25.8mmx25.8mm
 Through Hole Diameter: 0.2mm

Loss of PCB capacitors and connectors

Frequency(GHz)	Loss(dB)
0.7	0.24
1.0	0.29
2.0	0.45
2.7	0.59

PCB LAYOUT GUIDELINA (QFN9-94)

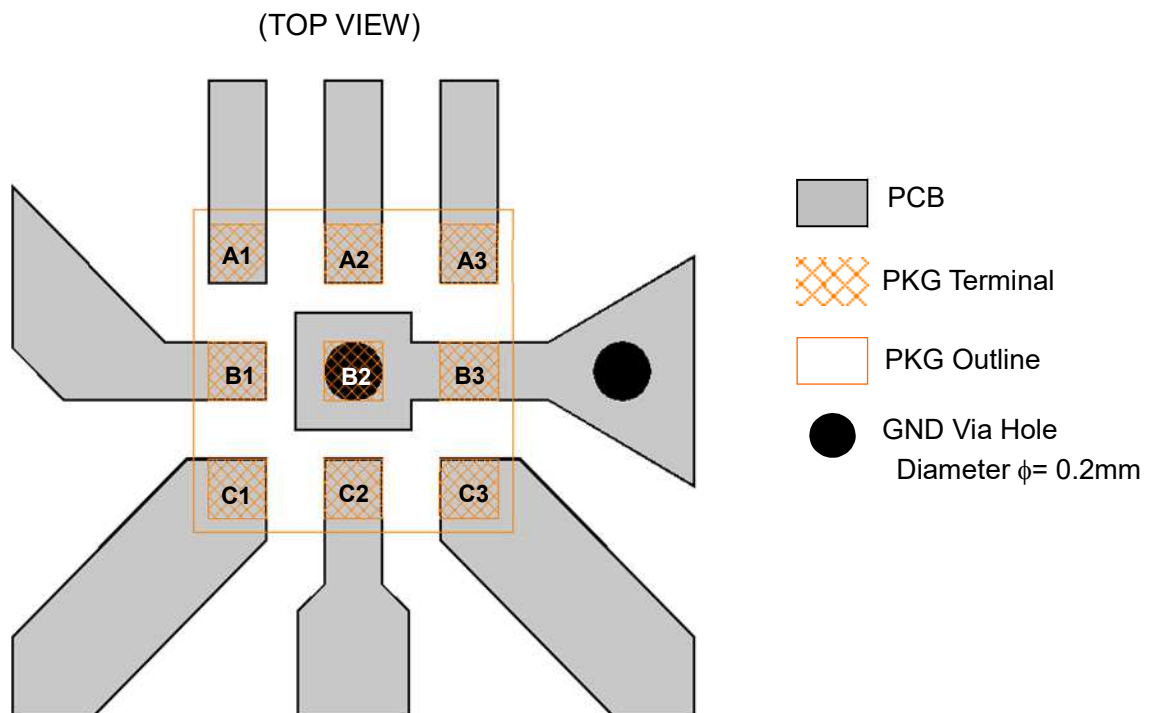



PRECAUTIONS

For good isolation, the GND terminals must be connected to the PCB ground plane of substrate, and the through-holes connecting the backside ground plane should be placed near by the pin connection.

RECOMMENDED FOOTPRINT PATTERN (QFN9-94 Package 1.1x1.1mm) <Reference>

Package: 1.1mm x 1.1mm
 Pin pitch: 0.40mm

-  : Land
-  : Mask (Open area) *Metal mask thickness: 100μm
-  : Resist (Open area)

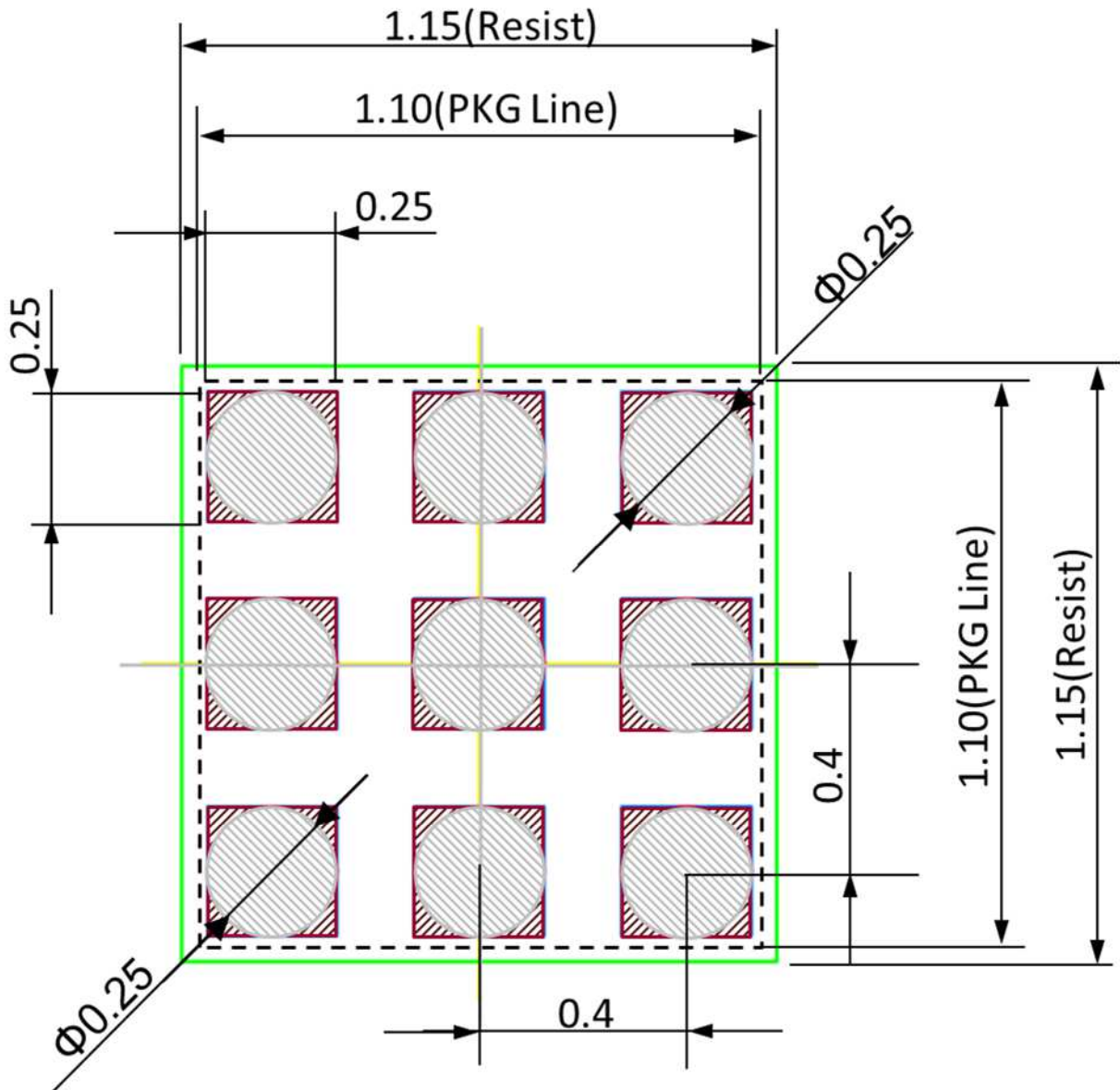

PACKAGE OUTLINE (QFN9-94)

TOP VIEW

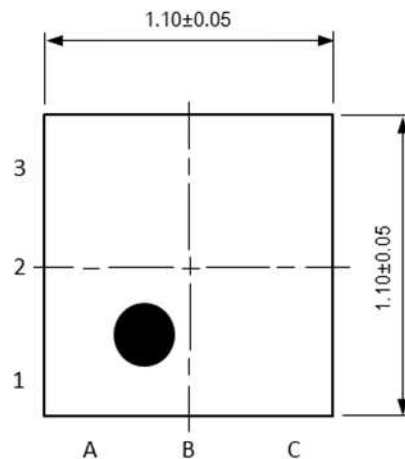

SIDE VIEW

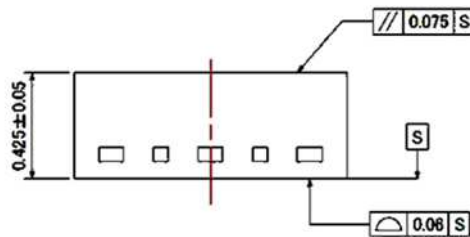

BOTTOM VIEW

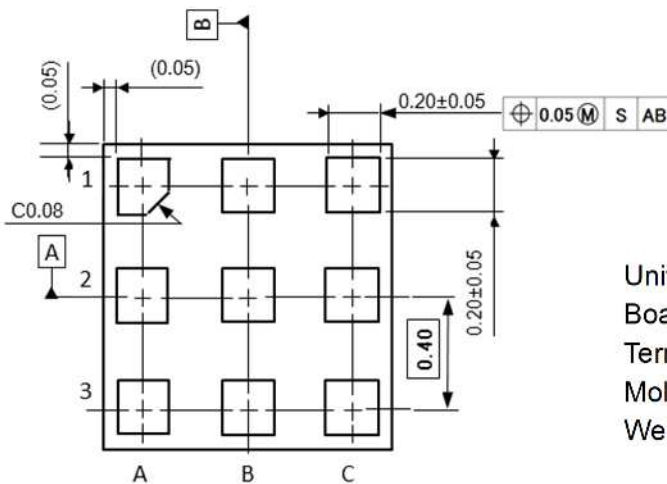

Unit	: mm
Board	: Copper
Terminal Treat	: Ni/Pd/Au
Molding Material	: Epoxy resin
Weight	: 1.5mg

Cautions on using this product

This product contains Gallium-Arsenide (GaAs) which is a harmful material.

- Do NOT eat or put into mouth.
- Do NOT dispose in fire or break up this product.
- Do NOT chemically make gas or powder with this product.
- To waste this product, please obey the relating law of your country.

This product may be damaged with electric static discharge (ESD) or spike voltage. Please handle with care to avoid these damages.

[CAUTION]

The specifications on this databook are only given for information, without any guarantee as regards either mistakes or omissions.

The application circuits in this databook are described only to show representative usages of the product and not intended for the guarantee or permission of any right including the industrial rights.

1. The products and the product specifications described in this document are subject to change or discontinuation of production without notice for reasons such as improvement. Therefore, before deciding to use the products, please refer to our sales representatives for the latest information thereon.
2. The materials in this document may not be copied or otherwise reproduced in whole or in part without the prior written consent of us.
3. This product and any technical information relating thereto are subject to complementary export controls (so-called KNOW controls) under the Foreign Exchange and Foreign Trade Law, and related politics ministerial ordinance of the law. (Note that the complementary export controls are inapplicable to any application-specific products, except rockets and pilotless aircraft, that are insusceptible to design or program changes.) Accordingly, when exporting or carrying abroad this product, follow the Foreign Exchange and Foreign Trade Control Law and its related regulations with respect to the complementary export controls.
4. The technical information described in this document shows typical characteristics and example application circuits for the products. The release of such information is not to be construed as a warranty of or a grant of license under our or any third party's intellectual property rights or any other rights.
5. The products listed in this document are intended and designed for use as general electronic components in standard applications (office equipment, telecommunication equipment, measuring instruments, consumer electronic products, amusement equipment etc.). Those customers intending to use a product in an application requiring extreme quality and reliability, for example, in a highly specific application where the failure or misoperation of the product could result in human injury or death should first contact us.
 - Aerospace Equipment
 - Equipment Used in the Deep Sea
 - Power Generator Control Equipment (nuclear, steam, hydraulic, etc.)
 - Life Maintenance Medical Equipment
 - Fire Alarms / Intruder Detectors
 - Vehicle Control Equipment (automotive, airplane, railroad, ship, etc.)
 - Various Safety Devices
 - Traffic control system
 - Combustion equipment

In case your company desires to use this product for any applications other than general electronic equipment mentioned above, make sure to contact our company in advance. Note that the important requirements mentioned in this section are not applicable to cases where operation requirements such as application conditions are confirmed by our company in writing after consultation with your company.

6. We are making our continuous effort to improve the quality and reliability of our products, but semiconductor products are likely to fail with certain probability. In order to prevent any injury to persons or damages to property resulting from such failure, customers should be careful enough to incorporate safety measures in their design, such as redundancy feature, fire containment feature and fail-safe feature. We do not assume any liability or responsibility for any loss or damage arising from misuse or inappropriate use of the products.
7. The products have been designed and tested to function within controlled environmental conditions. Do not use products under conditions that deviate from methods or applications specified in this datasheet. Failure to employ the products in the proper applications can lead to deterioration, destruction or failure of the products. We shall not be responsible for any bodily injury, fires or accident, property damage or any consequential damages resulting from misuse or misapplication of the products.
8. **Quality Warranty**
 - 8-1. **Quality Warranty Period**

In the case of a product purchased through an authorized distributor or directly from us, the warranty period for this product shall be one (1) year after delivery to your company. For defective products that occurred during this period, we will take the quality warranty measures described in section 8-2. However, if there is an agreement on the warranty period in the basic transaction agreement, quality assurance agreement, delivery specifications, etc., it shall be followed.
 - 8-2. **Quality Warranty Remedies**

When it has been proved defective due to manufacturing factors as a result of defect analysis by us, we will either deliver a substitute for the defective product or refund the purchase price of the defective product.

Note that such delivery or refund is sole and exclusive remedies to your company for the defective product.
 - 8-3. **Remedies after Quality Warranty Period**

With respect to any defect of this product found after the quality warranty period, the defect will be analyzed by us. On the basis of the defect analysis results, the scope and amounts of damage shall be determined by mutual agreement of both parties. Then we will deal with upper limit in Section 8-2. This provision is not intended to limit any legal rights of your company.
9. Anti-radiation design is not implemented in the products described in this document.
10. The X-ray exposure can influence functions and characteristics of the products. Confirm the product functions and characteristics in the evaluation stage.
11. WLCSP products should be used in light shielded environments. The light exposure can influence functions and characteristics of the products under operation or storage.
12. Warning for handling Gallium and Arsenic (GaAs) products (Applying to GaAs MMIC, Photo Reflector). These products use Gallium (Ga) and Arsenic (As) which are specified as poisonous chemicals by law. For the prevention of a hazard, do not burn, destroy, or process chemically to make them as gas or power. When the product is disposed of, please follow the related regulation and do not mix this with general industrial waste or household waste.
13. Please contact our sales representatives should you have any questions or comments concerning the products or the technical information.



Nisshinbo Micro Devices Inc.

Official website

<https://www.nisshinbo-microdevices.co.jp/en/>

Purchase information

<https://www.nisshinbo-microdevices.co.jp/en/buy/>