



MPQ8636GV/MPQ8636HGV

High Efficiency, 20A, 18V
Synchronous, Step-Down Converter

The Future of Analog IC Technology®

DESCRIPTION

The MPQ8636GV-20/MPQ8636HGV-20 is a fully-integrated, high-frequency, synchronous, rectified, step-down, switch-mode converter. It offers a very compact solution to achieve 20A output current over a wide input supply range, with excellent load and line regulation. The MPQ8636GV-20/MPQ8636HGV-20 operates at high efficiency over a wide output-current-load range.

The MPQ8636GV-20/MPQ8636HGV-20 uses Constant-On-Time (COT) control to provide a fast transient response and ease loop stabilization.

An external resistor programs the operating frequency from 200kHz to 1MHz, and the frequency keeps nearly constant as input supply varies with the feed-forward compensation.

The default under-voltage lockout threshold is internally set at 4.1V, but a resistor network on the enable pin can increase this threshold. The soft-start pin controls the output-voltage startup ramp. An open-drain power-good signal indicates that the output is within nominal voltage range.

It has fully-integrated protection features that include over-current protection, over-voltage protection and thermal shutdown.

The MPQ8636GV-20/MPQ8636HGV-20 requires a minimal number of readily-available, standard, external components and is available in a 5mm×4mm 25-Pin QFN package.

FEATURES

- Wide 4.5V-to-18V Operating Input Range
- 20A Output Current
- Low $R_{DS(ON)}$ Internal Power MOSFETs
- Proprietary Switching-Loss-Reduction Technique
- Adaptive COT for Ultrafast Transient Response
- 0.5% Reference Voltage Over 0°C to 70°C Junction Temperature Range
- Programmable Soft-Start Time
- Pre-Bias Start-Up
- Programmable Switching Frequency from 200kHz to 1MHz
- Non-Latch OCP, OVP, and Thermal Shutdown
- Output Adjustable from 0.611V to 13V

APPLICATIONS

- Telecom and Networking Systems
- Base Stations
- Servers
- Personal Video Recorders
- Flat-Panel Televisions and Monitors
- Distributed Power Systems

All MPS parts are lead-free and adhere to the RoHS directive. For MPS green status, please visit MPS website under Products, Quality Assurance page.

"MPS" and "The Future of Analog IC Technology" are registered trademarks of Monolithic Power Systems, Inc.

TYPICAL APPLICATION

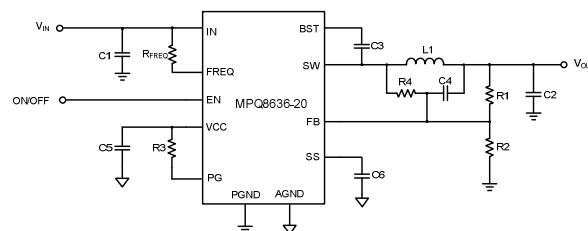

ORDERING INFORMATION

Part Number	Package	Top Marking
MPQ8636GV-20*	25-Pin QFN(5x4mm)	MP8636 20
MPQ8636HGV-20	25-Pin QFN(5x4mm)	MP8636H 20

* For Tape & Reel, add suffix -Z (e.g. MPQ8636GV-20-Z)

PACKAGE REFERENCE

TOP VIEW		TOP VIEW	
Part Number*	Package	Part Number**	Package
MPQ8636GV-20	QFN (5x4mm)	MPQ8636HGV-20	QFN (5x4mm)
Junction Temperature	Top Marking	Junction Temperature	Top Marking
-40°C to +125°C	MP8636 20	-40°C to +125°C	MP8636H 20
* For Tape & Reel, add suffix -Z (eg. MPQ8636GV-20-Z)		** For Tape & Reel, add suffix -Z (eg. MPQ8636HGV-20-Z)	

ABSOLUTE MAXIMUM RATINGS ⁽¹⁾

Supply Voltage V_{IN}	21V
V_{SW}	-0.3V to $V_{IN} + 0.3V$
V_{SW} (30ns)	-3V to $V_{IN} + 3V$
V_{BST}	$V_{SW} + 6V$
V_{BST} (30ns).....	$V_{SW} + 6.5V$
Enable Current I_{EN} ⁽²⁾	2.5mA
All Other Pins.....	-0.3V to +6V
Continuous Power Dissipation ($T_A=+25^\circ$) ⁽³⁾	
QFN5X4.....	3.3W
Junction Temperature.....	150°C
Lead Temperature	260°C
Storage Temperature.....	-65°C to +150°C

Recommended Operating Conditions ⁽⁴⁾

Supply Voltage V_{IN}	4.5V to 18V
Output Voltage V_{OUT}	0.611V to 13V
Enable Current I_{EN}	1mA
Operating Junction Temp. (T_J).....	-40°C to +125°C

Thermal Resistance ⁽⁵⁾	θ_{JA}	θ_{JC}	
QFN (5x4mm)	38	6	°C/W

Notes:

- 1) Exceeding these ratings may damage the device.
- 2) Refer to the section "Configuring the EN Control".
- 3) The maximum allowable power dissipation is a function of the maximum junction temperature $T_J(MAX)$, the junction-to-ambient thermal resistance θ_{JA} , and the ambient temperature T_A . The maximum allowable continuous power dissipation at any ambient temperature is calculated by $P_D(MAX)=(T_J(MAX)-T_A)/\theta_{JA}$. Exceeding the maximum allowable power dissipation will cause excessive die temperature, and the regulator will go into thermal shutdown. Internal thermal shutdown circuitry protects the device from permanent damage.
- 4) The device is not guaranteed to function outside of its operating conditions.
- 5) Measured on JESD51-7, 4-layer PCB.

ELECTRICAL CHARACTERISTICS

$V_{IN} = 12V$, $T_J = -40^{\circ}C$ to $+125^{\circ}C$, unless otherwise noted.

Parameters	Symbol	Condition	Min	Typ	Max	Units
Supply Current						
Supply Current (Shutdown)	I_{IN}	$V_{EN} = 0V$		0	1	μA
Supply Current (Quiescent)	I_{IN}	$V_{EN} = 2V$, $V_{FB} = 1V$	800	1000	1200	μA
MOSFET						
High-Side Switch-On Resistance	HS_{RDS-ON}	$T_J = 25^{\circ}C$		9.9		m Ω
Low-Side Switch-On Resistance	LS_{RDS-ON}	$T_J = 25^{\circ}C$		2.4		m Ω
Switch Leakage	SW_{LKG}	$V_{EN} = 0V$, $V_{SW} = 0V$ or $12V$		0	10	μA
Current Limit						
Low-Side Valley Current Limit ⁽⁶⁾	I_{LIMIT_VALLEY}		20	25	30	A
Low-Side Negative Current Limit ⁽⁶⁾	$I_{LIMIT_NEGATIVE}$	MPQ8636GV-20	-6.5	-5	-4.5	A
		MPQ8636HGV-20	-17	-13	-9	
Timer						
One-Shot ON Time	τ_{ON}	$R_{FREQ} = 453k\Omega$, $V_{OUT} = 1.2V$		250		ns
Minimum On Time ⁽⁶⁾	τ_{ON_MIN}		20	30	40	ns
Minimum OFF Time ⁽⁶⁾	τ_{OFF_MIN}		200	360	420	ns
Over-Voltage and Under-Voltage Protection						
OVP Non-Latch Threshold	$V_{OVP_NON-LATCH}$		117%	120%	123%	V_{FB}
OVP Delay	τ_{OVP}			2		μs
UVP Threshold ⁽⁶⁾	V_{UVP}		47%	50%	53%	V_{FB}
Reference and Soft Start						
Reference Voltage	V_{REF}	$T_J = 0^{\circ}C$ to $+70^{\circ}C$	608	611	614	mV
		$T_J = 0^{\circ}C$ to $+125^{\circ}C$	605	611	617	mV
		$T_J = -40^{\circ}C$ to $+125^{\circ}C$	602	611	620	mV
Feedback Current	I_{FB}	$V_{FB} = 611mV$		50	100	nA
Soft Start Charging Current	I_{SS}	$V_{SS} = 0V$	16	20	25	μA

ELECTRICAL CHARACTERISTICS *(continued)*
 $V_{IN} = 12V$, $T_J = -40^{\circ}C$ to $+125^{\circ}C$, unless otherwise noted.

Parameters	Symbol	Condition	Min	Typ	Max	Units
Enable And UVLO						
Enable Input, Low Voltage	$V_{IL_{EN}}$		1.1	1.3	1.5	V
Enable, Hysteresis	V_{EN-HYS}			250		mV
Enable, Input Current	I_{EN}	$V_{EN} = 2V$		0		μA
		$V_{EN} = 0V$		0		
VCC Regulator						
VCC Under-Voltage Lockout, Threshold Rising	VCC_{Vth}			4.0		V
VCC Under-Voltage Lockout, Threshold Hysteresis	VCC_{HYS}			500		mV
VCC Regulator	VCC			5.0		V
VCC Load Regulation		$I_{CC}=5mA$		0.5		%
Power-Good						
Power-Good, Rising Threshold	PG_{Vth-Hi}		87%	91%	94%	V_{FB}
Power-Good, Falling Threshold	PG_{Vth-Lo}			80%		V_{FB}
Power-Good, Low-to High-Delay	PG_{Td}			2.5		ms
Power Good, Sink Current Capability	I_{OL}	$V_{OL}=600mA$			12	mA
Power Good, Leakage Current	I_{PG_LEAK}	$V_{PG} = 3.3V$		10		nA
Thermal Protection						
Thermal Shutdown	T_{SD}	Note 5	150			$^{\circ}C$
Thermal Shutdown, Hysteresis				25		$^{\circ}C$

Note:

6) Guaranteed by design.

PIN FUNCTIONS

MPQ8636GV-20, MPQ8636HGV-20

PIN # 25-Pin QFN (5x4mm)	Name	Description
1	EN	Enable. Digital input that turns the regulator on or off. Drive EN high to turn on the regulator; drive it low to turn it off. Connect EN to IN through a pull-up resistor or a resistive voltage divider for automatic startup. Do not float this pin.
2	FREQ	Frequency Set. Require a resistor connected between FREQ and IN to set the switching frequency. The input voltage and the resistor connected to the FREQ pin determine the ON time. The connection to the IN pin provides line feed-forward and stabilizes the frequency during input voltage's variation.
3	FB	Feedback. Connect to the tap of an external resistor divider from the output to GND to set the output voltage. Place the resistor divider as close to FB pin as possible. Avoid using vias on the FB traces.
4	SS	Soft-Start. Connect an external capacitor to program the soft start time for the switch mode regulator.
5	AGND	Analog Ground. The control circuit reference.
6	PG	Power-Good. The output is an open drain signal. Requires a pull-up resistor to a DC voltage to indicate HIGH if the output voltage exceeds 91% of the nominal voltage. There is a delay from $FB \geq 91\%$ to when PG goes high.
7	VCC	Internal 4.8V LDO Output. Powers the driver and control circuits. Decouple with a $\geq 1\mu\text{F}$ ceramic capacitor as close to the pin as possible. For best results, use X7R or X5R dielectric ceramic capacitors for their stable temperature characteristics.
8	BST	Bootstrap. Require a capacitor connected between SW and BST pins to form a floating supply across the high-side switch driver.
9-13	SW	Switch Output. Connect to the inductor and bootstrap capacitor. The high-side switch drives these pins up to V_{IN} during the PWM duty cycle's ON time. The inductor current drives the SW pin negative during the OFF-time. The low-side switch's ON-resistance and the internal Schottky diode holds the negative voltage. Connect all SW pins using wide PCB traces.
14-24	PGND	System Ground. Reference ground of the regulated output voltage. PCB layout requires extra care. Connect using wide PCB traces.
25	IN	Supply Voltage. Supplies power to the internal MOSFET and regulator. The MPQ8636GV-20/MPQ8636HGV-20 operates from a 4.5V-to-18V input rail. Requires an input decoupling capacitor. Connect using wide PCB traces and multiple vias.

TYPICAL CHARACTERISTICS

MPQ8636-20, $V_{IN} = 12V$, $V_{OUT} = 1V$, $L = 0.72\mu H$, $T_A = 25^\circ C$, unless otherwise noted.

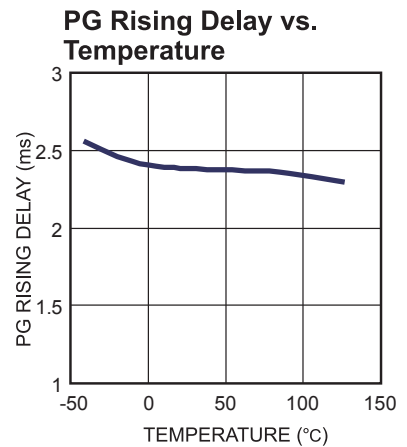
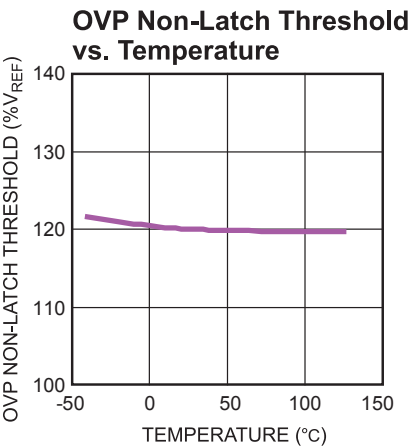
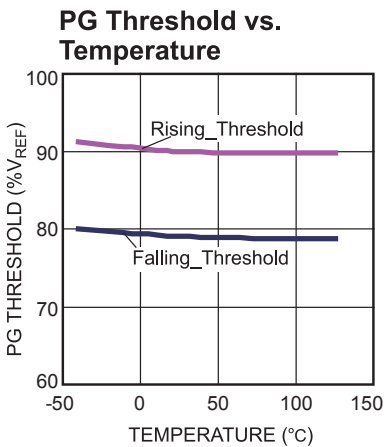
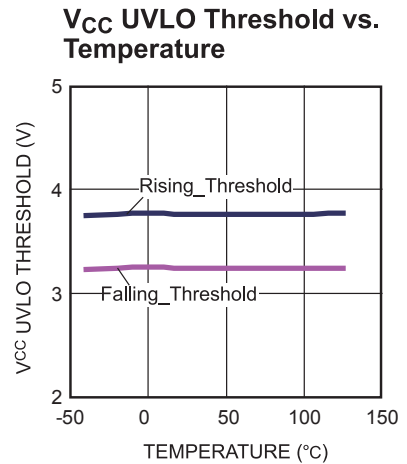
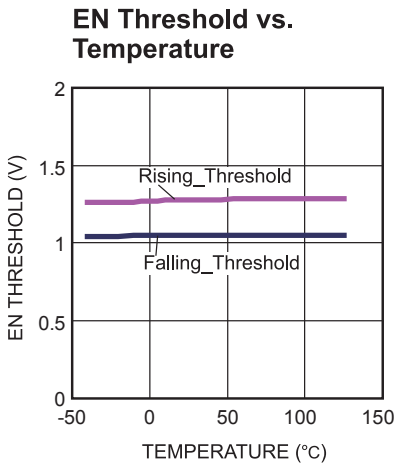
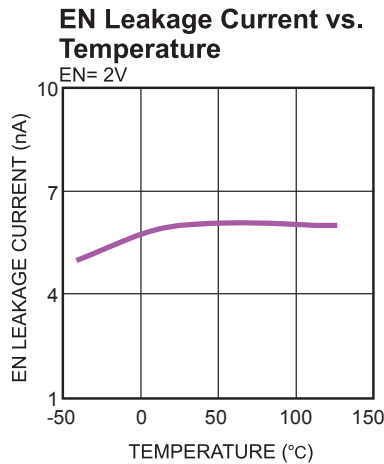
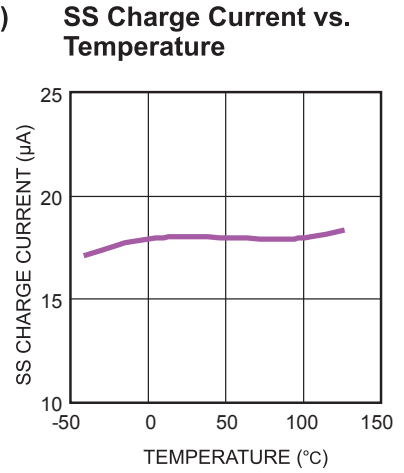
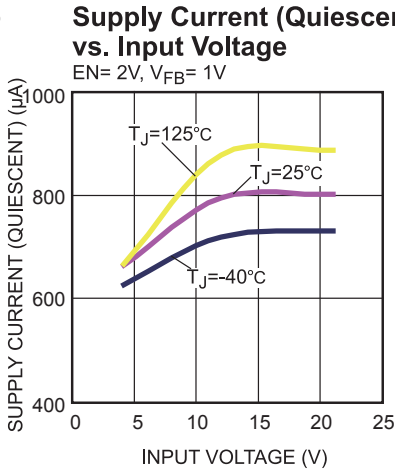
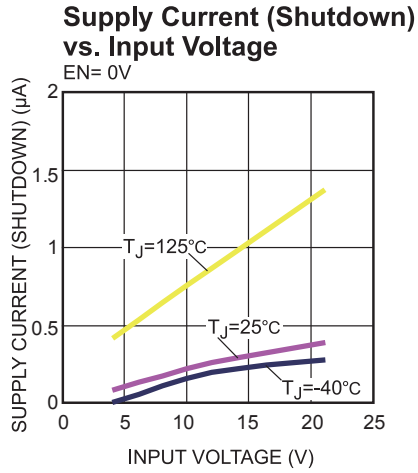

TYPICAL CHARACTERISTICS (continued)

MPQ8636-20, $V_{IN} = 12V$, $V_{OUT} = 1V$, $L = 0.72\mu H$, $T_A = 25^\circ C$, unless otherwise noted.

Valley Current Limit vs. Input Voltage

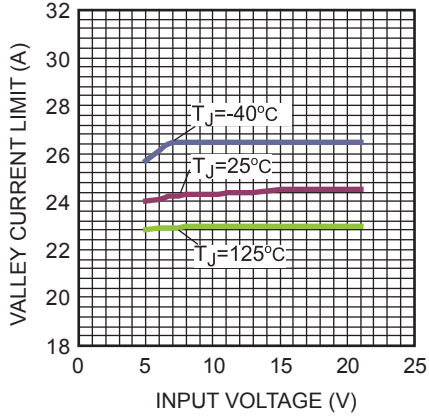

V_{CC} Voltage vs. Temperature

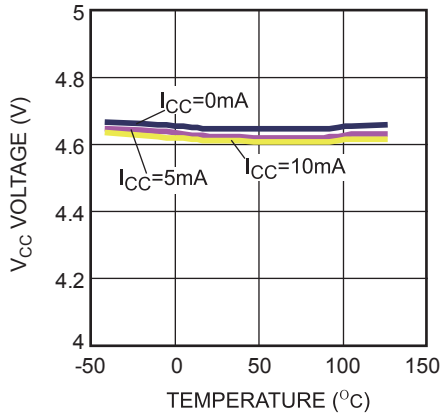

BST Voltage vs. Temperature

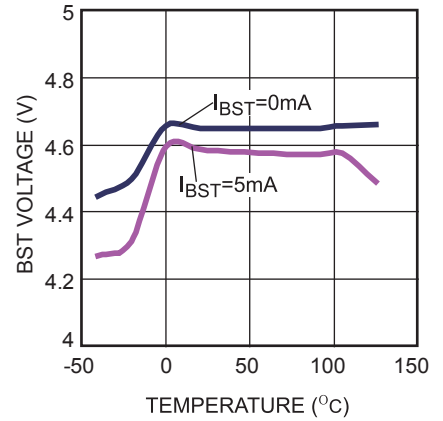

Switching Frequency vs. Temperature

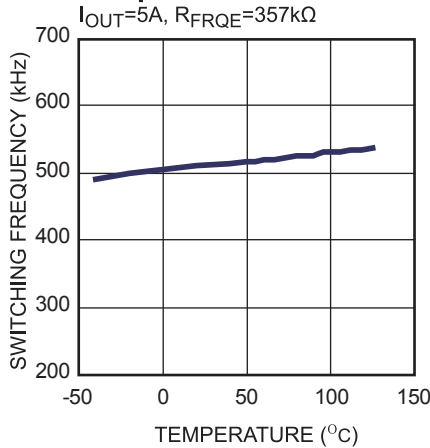

Switching Frequency vs. R_{FREQ}

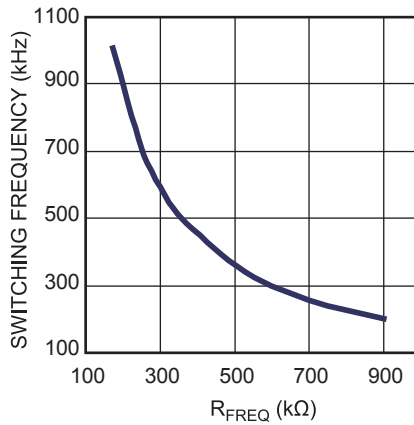

TYPICAL PERFORMANCE CHARACTERISTICS

MPQ8636-20, $V_{IN} = 12V$, $V_{OUT} = 1V$, $L = 0.72\mu H$, $T_A = 25^\circ C$, unless otherwise noted.

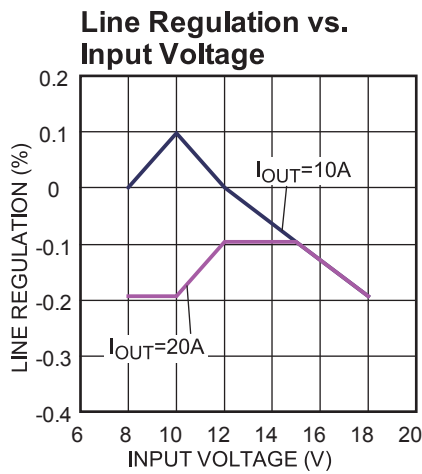
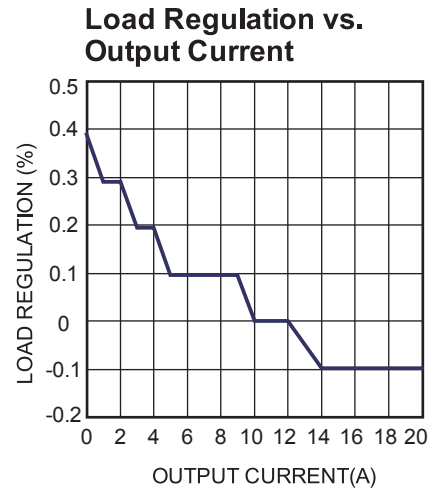
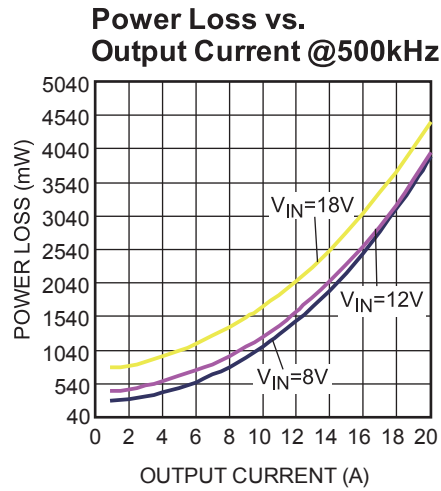
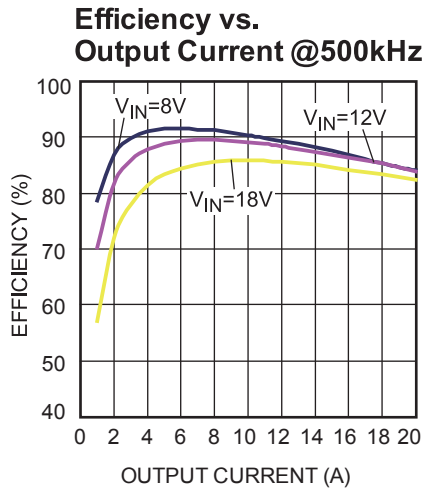

TYPICAL PERFORMANCE CHARACTERISTICS (continued)

MPQ8636-20, $V_{IN}=12V$, $V_{OUT}=1V$, $L=0.72\mu H$, $T_A=+25^\circ C$, unless otherwise noted.

Input/Output Voltage Ripple
 $I_{OUT} = 0A$

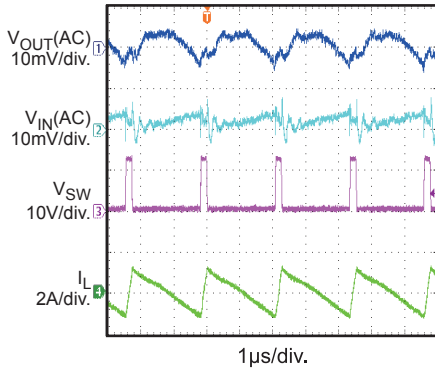

Input/Output Voltage Ripple
 $I_{OUT} = 20A$

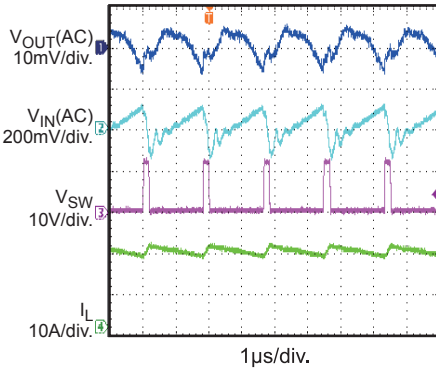

Power Good through EN Start Up
 $I_{OUT} = 0.5A$

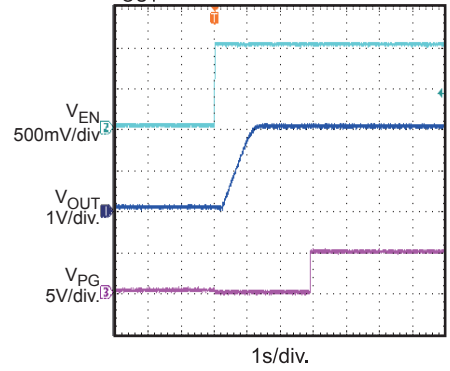

Power Good through EN Shutdown
 $I_{OUT} = 0.5A$

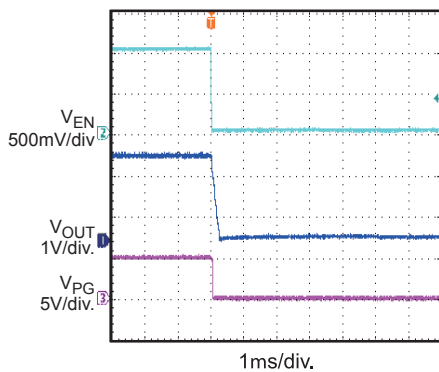

Start Up through VIN
 $I_{OUT} = 0A$

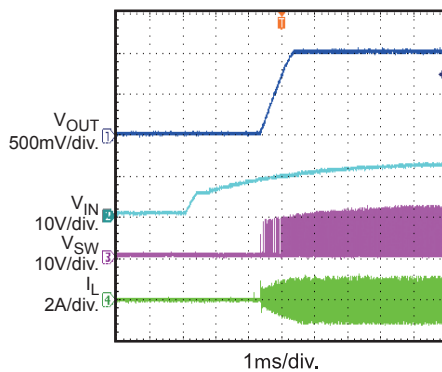

Start Up through VIN
 $I_{OUT} = 20A$

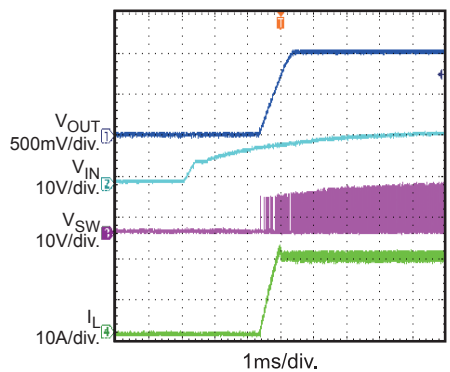

Shutdown through VIN
 $I_{OUT} = 0A$

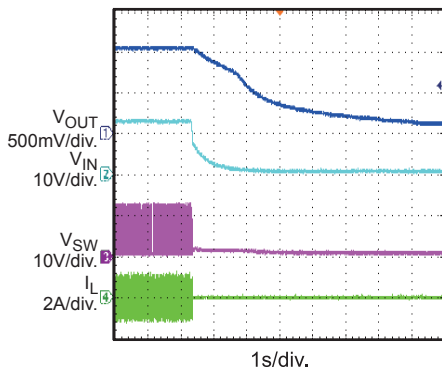

Shutdown through VIN
 $I_{OUT} = 20A$

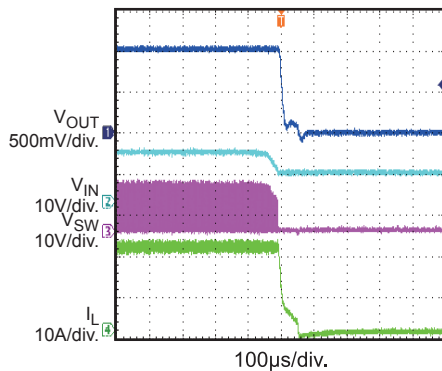

Shut Up through EN
 $I_{OUT} = 0A$

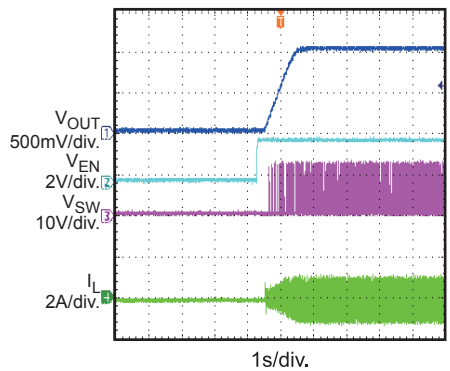

TYPICAL PERFORMANCE CHARACTERISTICS (continued)

MPQ8636-20, $V_{IN}=12V$, $V_{OUT}=1V$, $L=0.72\mu H$, $T_A=+25^\circ C$, unless otherwise noted.

Start Up through EN

$I_{OUT} = 20A$

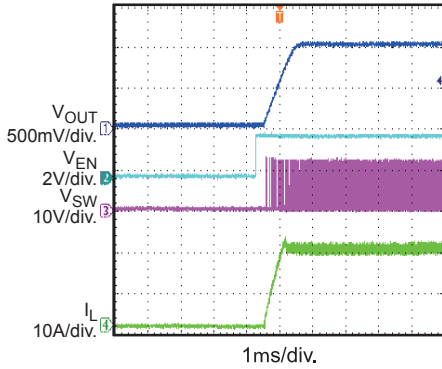

Shutdown through EN

$I_{OUT} = 0A$

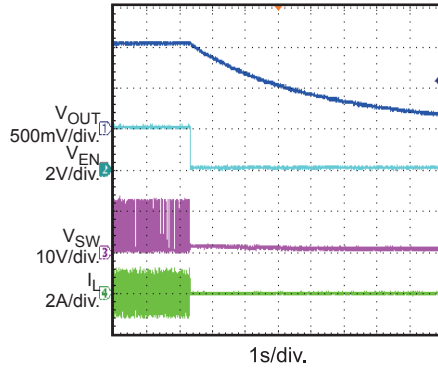

Shutdown through EN

$I_{OUT} = 20A$

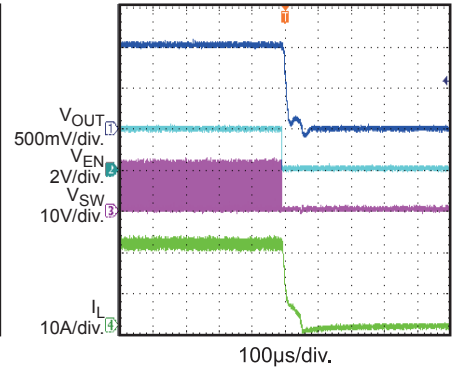

Transient

$I_{OUT} = 2-18A @ 1.6A/\mu s$,
 $F_{SW} = 500kHz$, $C_{OUT} = 3*47\mu F$, $L=0.3\mu H$

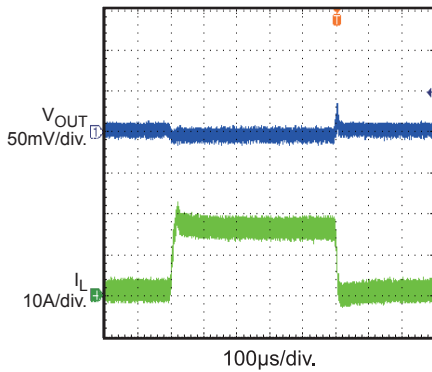

SCP

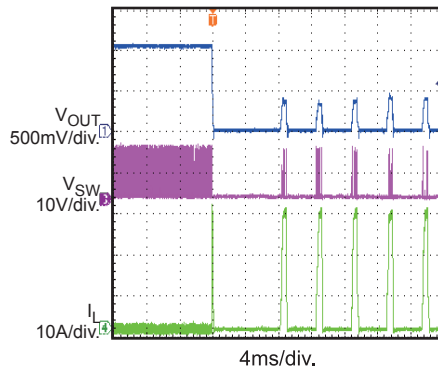

Thermal Shutdown

$I_{OUT} = 0A$

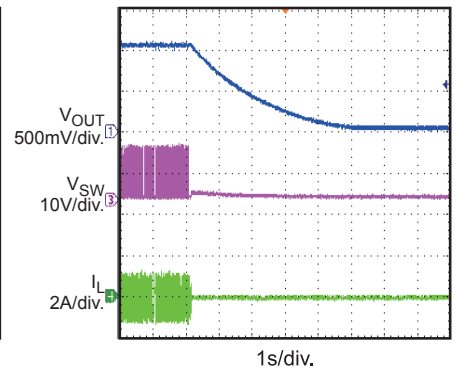

Thermal Recovery

$I_{OUT} = 20A$

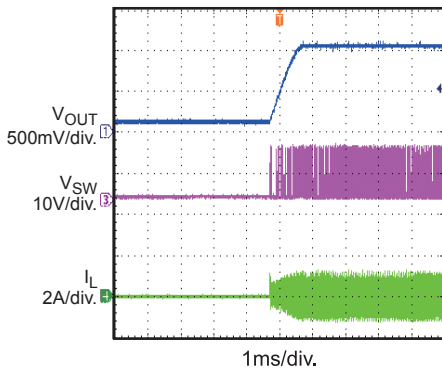

BLOCK DIAGRAM

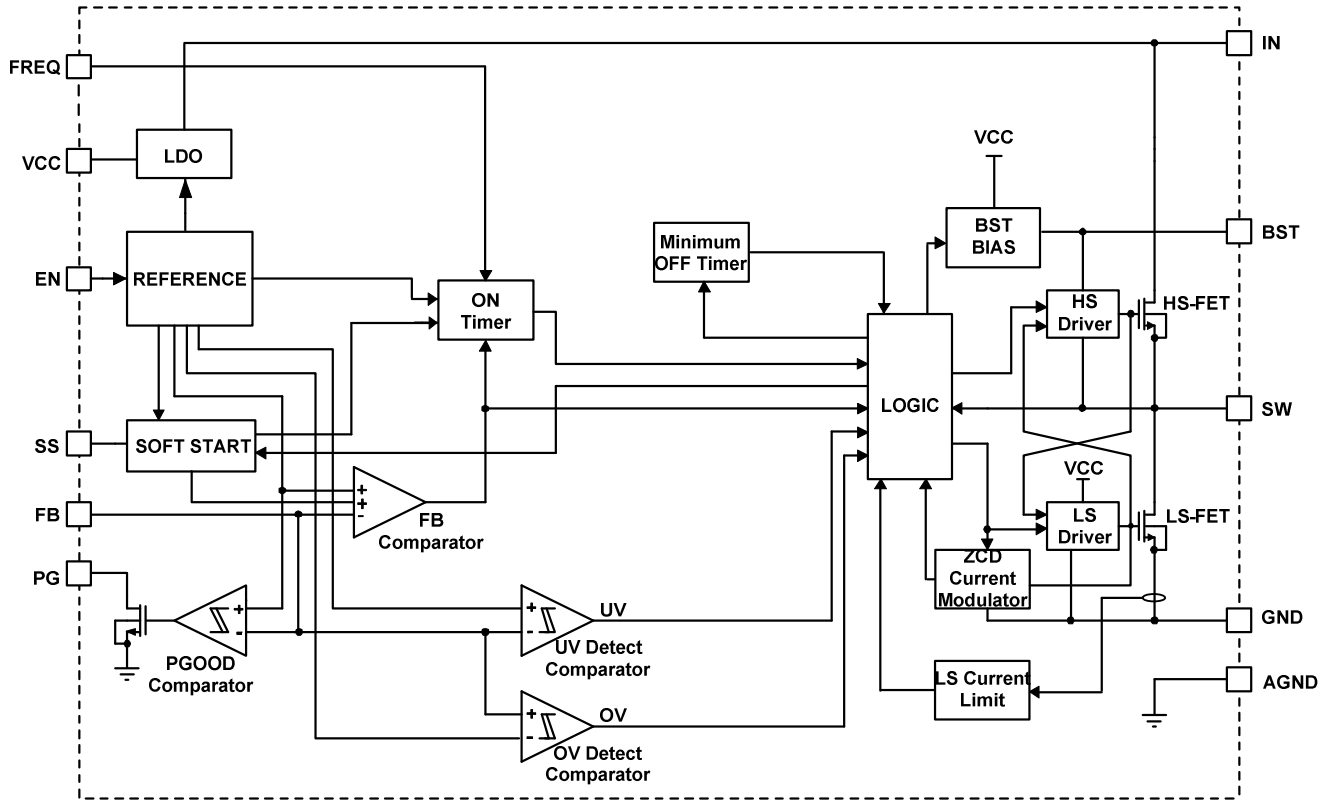

Figure 1: Functional Block Diagram

OPERATION

The MPQ8636GV-20/MPQ8636HGV-20 is a fully-integrated, synchronous, rectified, step-down, switch-mode converter. It uses constant-on-time (COT) control to provide a fast transient response and ease loop stabilization.

At the beginning of each cycle, the high-side MOSFET (HS-FET) turns ON when the feedback voltage (V_{FB}) drops below the reference voltage (V_{REF}), which indicates an insufficient output voltage. The input voltage and the frequency-set resistor determine the ON period as follows:

$$\tau_{ON}(ns) = \frac{6.1 \times R_{FREQ}(k\Omega)}{V_{IN}(V) - 0.4} \quad (1)$$

After the ON period elapses, the HS-FET turns off. It turns ON again when V_{FB} drops below V_{REF} . By repeating this operation, the converter regulates the output voltage. The integrated low-side MOSFET (LS-FET) turns on when the HS-FET is OFF to minimize the conduction loss. There is a dead short (or shoot-through) between input and GND if both HS-FET and LS-FET turn on at the same time. A dead-time (DT) internally generated between HS-FET OFF and LS-FET ON, or LS-FET OFF and HS-FET ON avoids shoot-through.

PWM Operation

MPQ8636GV-20/MPQ8636HGV-20 always functions in continuous-conduction mode (CCM), meaning the inductor current can go negative in light-load conditions. Figure 2 shows CCM operation. When V_{FB} is below V_{REF} , HS-FET turns on for a fixed interval determined by the one-shot on-timer, as per equation 1. When the HS-FET turns off, the LS-FET turns on until the next period.

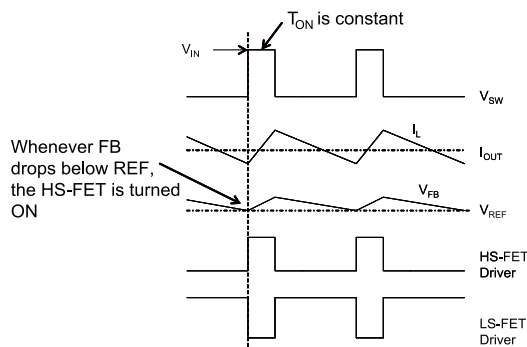

Figure 2: PWM Operation

In CCM operation, the switching frequency is fairly constant and is also called PWM mode.

Switching Frequency

Selecting the switching frequency requires trading off between efficiency and component size. Low-frequency operation increases efficiency by reducing MOSFET switching losses, but requires larger inductor and capacitor values to minimize the output voltage ripple.

For MPQ8636GV-20/MPQ8636HGV-20, set the ON time using the FREQ pin to set the frequency for steady-state operation on CCM.

The MPQ8636GV-20/MPQ8636HGV-20 uses adaptive constant-on-time (COT) control, though the IC lacks a dedicated oscillator. Connect the FREQ pin to the IN pin through the resistor (R_{FREQ}) so that the input voltage is feed-forwarded to the one-shot ON-time timer. When operating in steady state at CCM, the duty ratio stays at V_{OUT}/V_{IN} , so the switching frequency is fairly constant over the input voltage range. Set the switching frequency as follows:

$$f_{SW}(kHz) = \frac{10^6}{\frac{6.1 \times R_{FREQ}(k\Omega)}{V_{IN}(V) - 0.4} \times \frac{V_{IN}(V)}{V_{OUT}(V)} + \tau_{DELAY}(ns)} \quad (2)$$

Where τ_{DELAY} is the comparator delay of about 5ns.

Typically, the MPQ8636GV-20/MPQ8636HGV-20 is set to 200kHz to 1MHz applications. It is optimized to operate at high switching frequencies at high efficiency: high switching frequencies allow for physically smaller LC filter components to reduce the PCB footprint.

Jitter and FB Ramp Slope

Figure 3 shows jitter occurring in PWM mode. When there is noise on the V_{FB} descending slope, the HS-FET ON time deviates from its intended point and produces jitter, and influences system stability. The V_{FB} ripple's slope steepness dominates the noise immunity, though its magnitude has no direct effect.

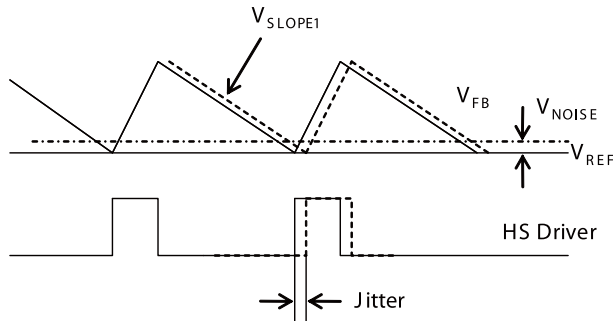

Figure 3: Jitter in PWM Mode

Ramp with a Large ESR Capacitor

Using POSCAPs or other large-ESR capacitors as the output capacitor results in the ESR ripple dominating the output ripple. The ESR also significantly influences the V_{FB} slope. Figure 4 shows the simplified equivalent circuit in PWM mode with the HS-FET OFF and without an external ramp circuit.

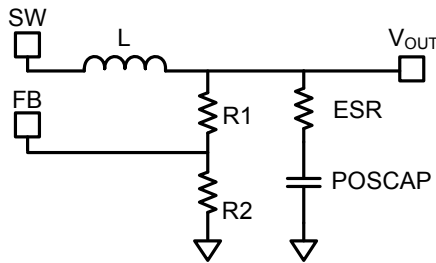

Figure 4: Simplified Circuit in PWM Mode without External Ramp Compensation

To realize the stability without an external ramp, usually select the ESR value as follows:

$$R_{ESR} \geq \frac{\frac{\tau_{SW}}{0.7 \times \pi} + \frac{\tau_{ON}}{2}}{C_{OUT}} \quad (3)$$

Where τ_{SW} is the switching period.

Ramp with a Small ESR Capacitor

Use an external ramp when using ceramic output capacitors because the ESR ripple is not high enough to stabilize the system.

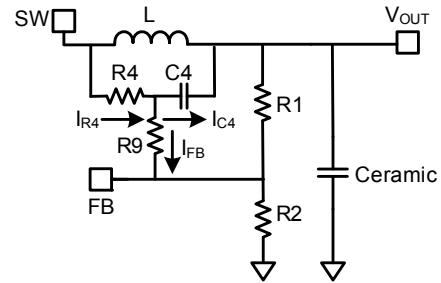

Figure 5: Simplified Circuit in PWM Mode with External Ramp Compensation

Figure 5 shows the simplified equivalent circuit in PWM mode with the HS-FET OFF and an external ramp compensation circuit (R4, C4). Design the external ramp based on the inductor ripple current. Select C4, R9, R1 and R2 to meet the following condition:

$$\frac{1}{2\pi \times f_{SW} \times C4} < \frac{1}{5} \times \left(\frac{R1 \times R2}{R1 + R2} + R9 \right) \quad (4)$$

Where:

$$I_{R4} = I_{C4} + I_{FB} \approx I_{C4} \quad (5)$$

Then estimate the ramp on V_{FB} as:

$$V_{RAMP} = \frac{V_{IN} - V_{OUT}}{R4 \times C4} \times \tau_{ON} \times \left(\frac{R1//R2}{R1//R2 + R9} \right) \quad (6)$$

The descending slope of the V_{FB} ripple then follows:

$$V_{SLOPE} = \frac{V_{RAMP}}{\tau_{OFF}} = \frac{-V_{OUT}}{R4 \times C4} \quad (7)$$

Equation 7 shows that if there is instability in PWM mode, reduce either R4 or C4. If C4 is irreducible due to equation 4 limitations, then reduce R4. For a stable PWM operation, design V_{SLOPE} based on equation 8.

$$-V_{SLOPE} \geq \frac{\frac{\tau_{SW}}{0.7 \times \pi} + \frac{\tau_{ON}}{2} - R_{ESR} \times C_{OUT}}{2 \times L \times C_{OUT}} \times V_{OUT} + \frac{I_{OUT} \times 10^{-3}}{\tau_{SW} - \tau_{ON}} \quad (8)$$

Where I_{OUT} is the load current.

Configuring the EN Control

The regulator turns on when EN goes HIGH; conversely it turns off when EN goes low. Do not float the pin.

For automatic start-up, pull the EN pin up to input voltage through a resistive voltage divider. Choose the values of the pull-up resistor (R_{UP} from the IN pin to the EN pin) and the pull-down resistor (R_{DOWN} from the EN pin to GND) to determine the automatic start-up voltage:

$$V_{IN-START} = 1.5 \times \frac{(R_{UP} + R_{DOWN})}{R_{DOWN}} (V) \quad (9)$$

For example, for $R_{UP}=100k\Omega$ and $R_{DOWN}=51k\Omega$, the $V_{IN-START}$ is set at 4.44V.

To reduce noise, add a 10nF ceramic capacitor from EN to GND.

An internal zener diode on the EN pin clamps the EN pin voltage to prevent runaway. The maximum pull-up current, assuming the worst-case 6V, for the internal zener clamp should be less than 1mA.

Therefore, when driving EN with an external logic signal, use an EN voltage less than 6V. When connecting EN to IN through a pull-up resistor or a resistive voltage divider, select a resistance that ensures a maximum pull-up current of less than 1mA.

If using a resistive voltage divider and V_{IN} exceeds 6V, then the minimum resistance for the pull-up resistor, R_{UP} , should meet:

$$\frac{V_{IN} - 6V}{R_{UP}} - \frac{6V}{R_{DOWN}} \leq 1mA \quad (10)$$

With only R_{UP} (the pull-down resistor, R_{DOWN} , is not connected), then the VCC UVLO threshold determines $V_{IN-START}$, so the minimum resistor value is:

$$R_{UP} \geq \frac{V_{IN} - 6V}{1mA} (\Omega) \quad (11)$$

A typical pull-up resistor is 100k Ω .

Soft Start

The MPQ8636GV-20/MPQ8636HGV-20 employs a soft start (SS) mechanism to ensure a smooth output during power-up. When the EN pin goes HIGH, an internal current source (20 μ A) charges

the SS capacitor. The SS capacitor voltage overtakes the REF voltage to the PWM comparator. The output voltage smoothly ramps up with the SS voltage. Once the SS voltage reaches the REF voltage, it continues ramping up while V_{REF} takes over the PWM comparator. At this point, soft-start finishes and the device enters steady-state operation.

Determine the SS capacitor value as follows:

$$C_{SS} (nF) = \frac{\tau_{SS} (ms) \times I_{SS} (\mu A)}{V_{REF} (V)} \quad (12)$$

If the output capacitors are large, then avoid setting a short SS time or risk hitting the current limit during SS. Use a minimum value of 4.7nF if the output capacitance value exceeds 330 μ F.

Pre-Bias Startup

The MPQ8636GV-20/MPQ8636HGV-20 has been designed for monotonic startup into pre-biased loads. If the output is pre-biased to a certain voltage during startup, the IC will disable switching for both high-side and low-side switches until the voltage on the soft-start capacitor exceeds the sensed output voltage at the FB pin.

Power Good (PG)

The MPQ8636GV-20/MPQ8636HGV-20 has a power-good (PG) output. The PG pin is the open drain of a MOSFET. Connect it to VCC or some other voltage source that measures less than 5.5V through a pull-up resistor (typically 100k Ω). After applying the input voltage, the MOSFET turns on so that the PG pin is pulled to GND before the SS is ready. After the FB voltage reaches 91% of the REF voltage, the PG pin is pulled HIGH after a 2.5ms delay.

When the FB voltage drops to 80% of the REF voltage or exceeds 120% of the nominal REF voltage, the PG pin is pulled LOW. If the input DC source fails to power the MPQ8636GV-20/MPQ8636HGV-20, the PG pin is also pulled low even though this pin is tied to an external DC source through a pull-up resistor (typically 100k Ω).

Over-Current Protection (OCP)

The MPQ8636GV-20/MPQ8636HGV-20 features two current limit levels for over-current conditions: low-side valley current limit and low-side negative current limit.

Low-Side Valley Current Limit: The device monitors the inductor current during the LS-FET ON state. At the end of the OFF time, the LS-FET sourcing current is compared to the internal positive-valley-current limit. If the valley current limit is less than the LS-FET sourcing current, the LS-FET keeps ON state until the valley current limit exceeds the LS-FET sourcing current. And then the LS-FET turns off, the HS-FET turns on for a fixed time determined by frequency-set resistor R_{FREQ} and input voltage.

During OCP, the device tries to recover from the over-current fault with hiccup mode: the chip disables the output power stage, discharges the soft-start capacitor and then automatically retries soft-start. If the over-current condition still holds after soft-start ends, the device repeats this operation cycle until the over-current conditions disappear and then output rises back to regulation level: OCP offers non-latch protection.

Low-Side Negative Current Limit: If the sensed LS-FET negative current exceeds the negative current limit, the LS-FET turns off immediately and stays OFF for the remainder of the OFF period. In this situation, both MOSFETs are OFF until the end of a fixed interval. The HS-FET body diode conducts the inductor current for the fixed time.

Over-Voltage Protection (OVP)

The MPQ8636GV-20/MPQ8636HGV-20 monitors the output voltage using the FB pin connected to the tap of a resistor divider to detect output over-voltage. MPQ8636 and MPQ8636H provide Non-Latch OVP and Hiccup mode as showed in Table 1.

Table 1: OVP Mode

OVP Mode	Non-Latch Mode	Hiccup Mode
Part #	MPQ8636-20	MPQ8636H-20

For MPQ8636GV-20:

If the FB voltage exceeds the nominal REF voltage but remains lower than 120% of the REF voltage (0.611V), both MOSFETs are OFF.

If the FB voltage exceeds 120% of the REF voltage but remains below 130%, the LS-FET turns on while the HS-FET remains off. The LS-FET remains on until the FB voltage drops below 110% of the REF voltage, or the low-side negative-current limit is hit.

If the FB voltage exceeds 130% of the REF voltage, the device enters a non-latch off mode. Once the FB voltage comes back to the reasonable value, it will exit this OVP mode and operate normally again.

For MPQ8636HGV-20:

If the FB voltage exceeds 120% of the REF voltage, the LS-FET turns on while the HS-FET remains off. The LS-FET remains on until the FB voltage drops below the REF voltage or the low-side negative current limit is hit.

During OVP, the device tries to recover from the over-voltage fault with hiccup mode: the chip disables the output power stage, discharges the soft-start capacitor. If the over-voltage condition still holds, the soft-start pin stays low. The device automatically soft starts up until the over-voltage conditions disappear and then output rises back to regulation level again.

UVLO Protection

The MPQ8636GV-20/MPQ8636HGV-20 has under-voltage lockout protection (UVLO). When the VCC voltage exceeds the UVLO rising-threshold voltage, the MPQ8636GV-20/MPQ8636HGV-20 powers up. It shuts off when the VCC voltage falls below the UVLO falling threshold voltage. This is non-latch protection.

The MPQ8636GV-20/MPQ8636HGV-20 is disabled when the VCC voltage falls below 3.3 V. If an application requires a higher UVLO threshold, use the two external resistors connected to the EN pin as shown in Figure 6 to adjust the startup input voltage. For best results, use the enable resistors to set the input-voltage falling threshold (V_{STOP}) above 3.6V. Set the

rising threshold (V_{START}) to provide enough hysteresis to account for any input supply variations.

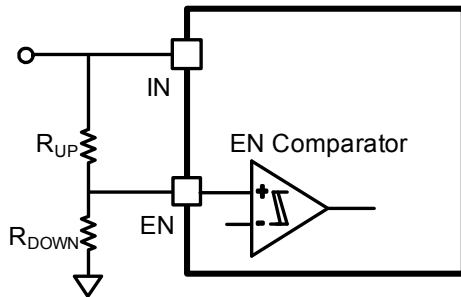

Figure 6: Adjustable UVLO Threshold

Thermal Shutdown

The MPQ8636GV-20/MPQ8636HGV-20 has thermal shutdown. The IC internally monitors the junction temperature. If the junction temperature exceeds the threshold value (minimum 150°C), the converter shuts off. This is a non-latch protection. There is about 25°C hysteresis. Once the junction temperature drops to about 125°C, it initiates a soft startup.

APPLICATION INFORMATION

Selecting the Output-Voltage-Large-ESR Capacitors

Capacitors

For applications that electrolytic capacitor or POS capacitor with a large ESR is set as output capacitors. The feedback resistors—R1 and R2, as shown in Figure 7—set the output voltage.

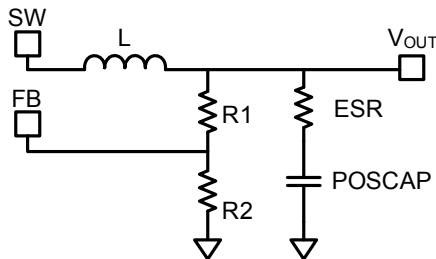

Figure 7: Simplified POSCAP Circuit

First, choose a value for R2 that balances between high quiescent current loss (low R2) and high noise sensitivity on FB (high R2). A typical value falls within 5kΩ to 50kΩ, using a comparatively larger R2 when V_{OUT} is low, and a smaller R2 when V_{OUT} is high. Then calculate R1 as follows, which considers the output ripple:

$$R1 = \frac{V_{OUT} - \frac{1}{2} \times \Delta V_{OUT} - V_{REF}}{V_{REF}} \times R2 \quad (13)$$

Where ΔV_{OUT} is the output ripple determined by equation 22.

Selecting the Output-Voltage Small-ESR Capacitors

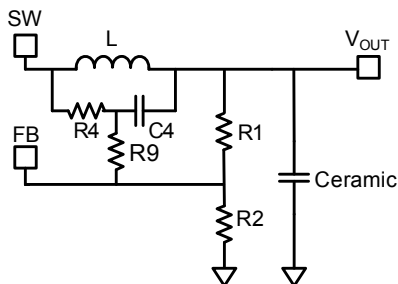

Figure 8: Simplified Ceramic Capacitor Circuit

When using a low-ESR ceramic capacitor on the output, add an external voltage ramp to the FB pin consisting of R4 and C4. The ramp voltage, V_{RAMP}, and the resistor divider influence the output voltage, as shown in Figure 8. Calculate V_{RAMP} as shown in equation 6. Select R2 to

balance between high quiescent current loss and FB noise sensitivity. Choose R2 within 5kΩ to 50kΩ, using a larger R2 when V_{OUT} is low, and a smaller R2 when V_{OUT} is high. Determine the value of R1 as follows:

$$R1 = \frac{R2}{\frac{V_{FB(AVG)}}{V_{OUT} - V_{FB(AVG)}} - \frac{R2}{R4 + R9}} \quad (14)$$

Where V_{FB(AVG)} is the average FB voltage. V_{FB(AVG)} varies with the V_{IN}, V_{OUT}, and load condition, where the load regulation is strictly related to the V_{FB(AVG)}. Also the line regulation is related to the V_{FB(AVG)}; improving the load or line regulation involves a lower V_{RAMP} that meets equation 8.

For PWM operation, estimate V_{FB(AVG)} from equation 15.

$$V_{FB(AVG)} = V_{REF} + \frac{1}{2} \times V_{RAMP} \times \frac{R1//R2}{R1//R2 + R9} \quad (15)$$

Usually, R9 is 0Ω, though it can also be set following equation 16 for better noise immunity. It should also be less than 20% of R1//R2 to minimize its influence on V_{RAMP}.

$$R9 < \frac{1}{5} \times \frac{R1 \times R2}{R1 + R2} \quad (16)$$

Using equations 14 and 15 to calculate the output voltage can be complicated. To simplify the R1 calculation in equation 14, add a DC-blocking capacitor, C_{DC}, to filter the DC influence from R4 and R9. Figure 9 shows a simplified circuit with external ramp compensation and a DC-blocking capacitor. The addition of this capacitor, simplifies the R1 calculation as per equation 17 for PWM mode operation.

$$R1 = \frac{V_{OUT} - V_{REF} - \frac{1}{2} \times V_{RAMP}}{V_{REF} + \frac{1}{2} \times V_{RAMP}} \times R2 \quad (17)$$

For best results, select a C_{DC} value at least 10×C4 for better DC-blocking performance, but smaller than 0.47μF to account for start-up performance. To use a larger C_{DC} for better FB noise immunity, reduce R1 and R2 to limit effects

on system start-up. Note that even with C_{DC} , the load and line regulation are still related to V_{RAMP} .

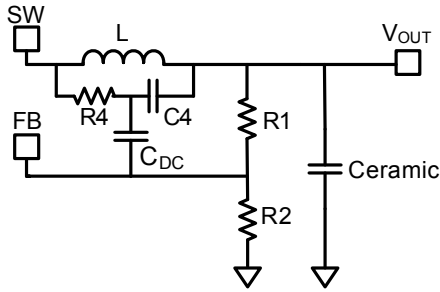

Figure 9: Simplified Ceramic Capacitor Circuit with DC-Blocking Capacitor

Input Capacitor

The input current to the step-down converter is discontinuous, and therefore, requires a capacitor to supply the AC current to the step-down converter while maintaining the DC input voltage. Use ceramic capacitors for best performance. During layout, place the input capacitors as close to the IN pin as possible.

The capacitance can vary significantly with temperature. Use capacitors with X5R and X7R ceramic dielectrics because they are fairly stable over a wide temperature range.

The capacitors must also have a ripple current rating that exceeds the converter's maximum input ripple current. Estimate the input ripple current as follows:

$$I_{CIN} = I_{OUT} \times \sqrt{\frac{V_{OUT}}{V_{IN}} \times \left(1 - \frac{V_{OUT}}{V_{IN}}\right)} \quad (18)$$

The worst-case condition occurs at $V_{IN} = 2V_{OUT}$, where:

$$I_{CIN} = \frac{I_{OUT}}{2} \quad (19)$$

For simplification, choose an input capacitor with an RMS current rating that exceeds half the maximum load current.

The input capacitance value determines the converter input voltage ripple. Select a capacitor value that meets any input-voltage-ripple requirements.

Estimate the input voltage ripple as follows:

$$\Delta V_{IN} = \frac{I_{OUT}}{f_{SW} \times C_{IN}} \times \frac{V_{OUT}}{V_{IN}} \times \left(1 - \frac{V_{OUT}}{V_{IN}}\right) \quad (20)$$

The worst-case condition occurs at $V_{IN} = 2V_{OUT}$, where:

$$\Delta V_{IN} = \frac{1}{4} \times \frac{I_{OUT}}{f_{SW} \times C_{IN}} \quad (21)$$

Output Capacitor

The output capacitor maintains the DC output voltage. Use ceramic capacitors or POSCAPs. Estimate the output voltage ripple as:

$$\Delta V_{OUT} = \frac{V_{OUT}}{f_{SW} \times L} \times \left(1 - \frac{V_{OUT}}{V_{IN}}\right) \times \left(R_{ESR} + \frac{1}{8 \times f_{SW} \times C_{OUT}}\right) \quad (22)$$

When using ceramic capacitors, the capacitance dominates the impedance at the switching frequency. The capacitance also dominates the output voltage ripple. For simplification, estimate the output voltage ripple as:

$$\Delta V_{OUT} = \frac{V_{OUT}}{8 \times f_{SW}^2 \times L \times C_{OUT}} \times \left(1 - \frac{V_{OUT}}{V_{IN}}\right) \quad (23)$$

The ESR only contributes minimally to the output voltage ripple, thus requiring an external ramp to stabilize the system. Design the external ramp with R4 and C4 as per equations 4, 7 and 8.

The ESR dominates the switching-frequency impedance for POSCAPs. The ESR ramp voltage is high enough to stabilize the system, thus eliminating the need for an external ramp. Select a minimum ESR value around 12mΩ to ensure stable converter operation. For simplification, the output ripple can be approximated as:

$$\Delta V_{OUT} = \frac{V_{OUT}}{f_{SW} \times L} \times \left(1 - \frac{V_{OUT}}{V_{IN}}\right) \times R_{ESR} \quad (24)$$

Inductor

The inductor supplies constant current to the output load while being driven by the switching input voltage. A larger-value inductor results in less ripple current and lower output-ripple voltage, but is larger physical size, has a higher series resistance, and/or lower saturation current.

Generally, select an inductor value that allows the inductor peak-to-peak ripple current to equal 30% to 40% of the maximum switch current limit. Also, design for a peak inductor current that is below the maximum switch current limit. The inductance value can be calculated as:

$$L = \frac{V_{OUT}}{f_{SW} \times \Delta I_L} \times \left(1 - \frac{V_{OUT}}{V_{IN}}\right) \quad (25)$$

Where ΔI_L is the peak-to-peak inductor ripple current.

Choose an inductor that will not saturate under the maximum inductor peak current. The peak inductor current can be calculated as:

$$I_{LP} = I_{OUT} + \frac{V_{OUT}}{2 \times f_{SW} \times L} \times \left(1 - \frac{V_{OUT}}{V_{IN}}\right) \quad (26)$$

Table 2 lists a few highly-recommended high-efficiency inductors.

Table 2: Inductor Selector Guide

Part Number	Manufacturer	Inductance (μH)	DCR (mΩ)	Current Rating (A)	Dimensions L x W x H (mm ³)	Switching Frequency (kHz)
744325072	Würth	0.72	1.35	35	10.2 x 10.5 x 4.7	500
HC1-R30-R	Cooper	0.3	0.36	31.8	13 x 13 x 10	500

Typical Design Parameter Tables

The following tables include recommended component values for typical output voltages (1V, 2.5V, 3.3V) at 500kHz switching frequency. Refer to Table 3 for design cases without external ramp compensation and Table 4 for design cases with external ramp compensation. An external ramp is not needed when using high-ESR capacitors, such as electrolytic or POSCAPs. Use an external ramp when using low-ESR capacitors, such as ceramic capacitors. For cases not listed in this datasheet, an excel spreadsheet provided by local sales representatives can assist with the calculations.

Table 3: f_{SW}=500kHz, V_{IN}=12V

V _{OUT} (V)	L (μH)	R1 (kΩ)	R2 (kΩ)	R7 (kΩ)
1	0.72	13.3	20	357
2.5	0.72	63.4	20	887
3.3	0.72	91	20	1200

Table 4: f_{SW}=500kHz, V_{IN}=12V

V _{OUT} (V)	L (μH)	R1 (kΩ)	R2 (kΩ)	R4 (kΩ)	C4 (pF)	R7 (kΩ)
1	0.72	13.7	20	750	220	357
2.5	0.72	68	20	1000	220	887
3.3	0.72	95.3	20	1200	220	1200

TYPICAL APPLICATION (7)

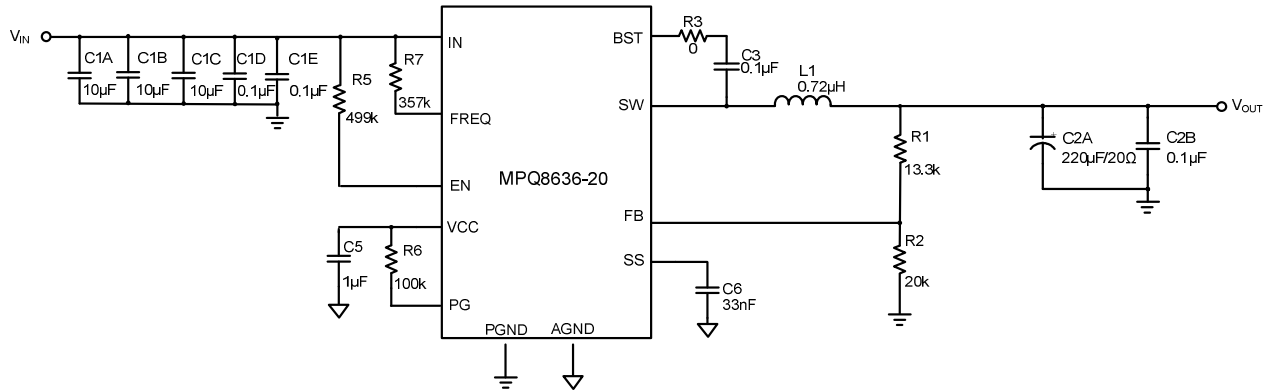

Figure 10 — Typical Application Circuit with No External Ramp

MPQ8636-20, $V_{IN}=12V$, $V_{OUT}=1V$, $I_{OUT}=20A$, $f_{SW}=500kHz$

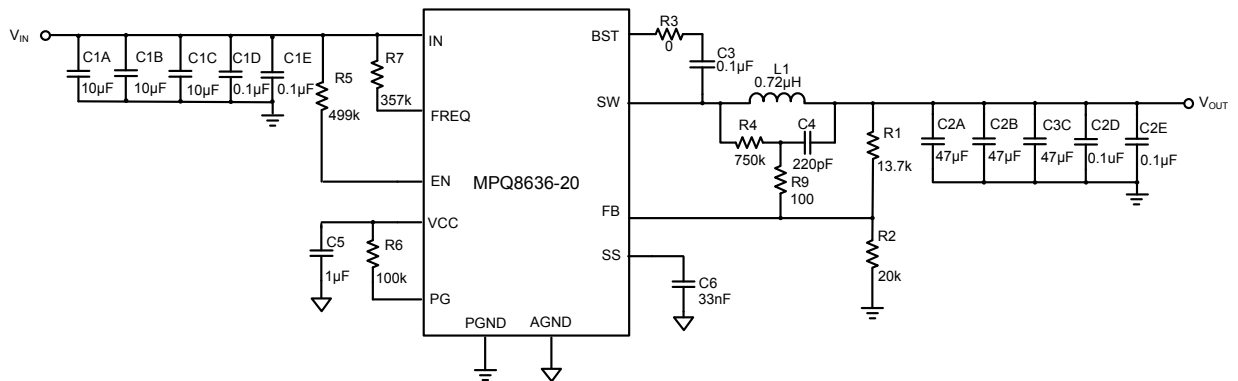

Figure 11 — Typical Application Circuit with Low ESR Ceramic Capacitor

MPQ8636-20, $V_{IN}=12V$, $V_{OUT}=1V$, $I_{OUT}=20A$, $f_{SW}=500kHz$

NOTE:

7) The all application circuits' steady states are OK, but other performances are not tested.

LAYOUT RECOMMENDATION

1. Place high current paths (GND, IN, and SW) very close to the device with short, direct and wide traces.
2. Two-layer IN copper layers are required to achieve better performance. Respectively put at least a decoupling capacitor on both Top and Bottom layers and as close to the IN and GND pins as possible. Also, several vias with 18mil diameter and 8mil hole-size are required to be placed under the device and near input capacitors to help on the thermal dissipation, also reduce the parasitic inductance.
3. Put a decoupling capacitor as close to the VCC and AGND pins as possible.
4. Keep the switching node (SW) plane as small as possible and far away from the feedback network.
5. Place the external feedback resistors next to the FB pin. Make sure that there are no vias on the FB trace. The feedback resistors should refer to AGND instead of PGND.
6. Keep the BST voltage path (BST, C3, and SW) as short as possible.
7. Recommend strongly a four-layer layout to improve thermal performance.

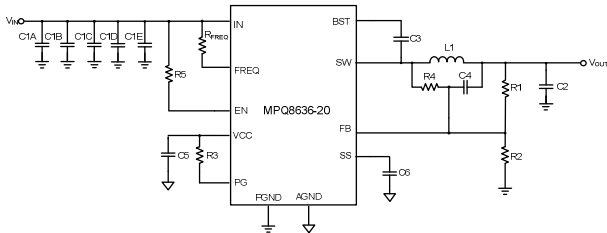
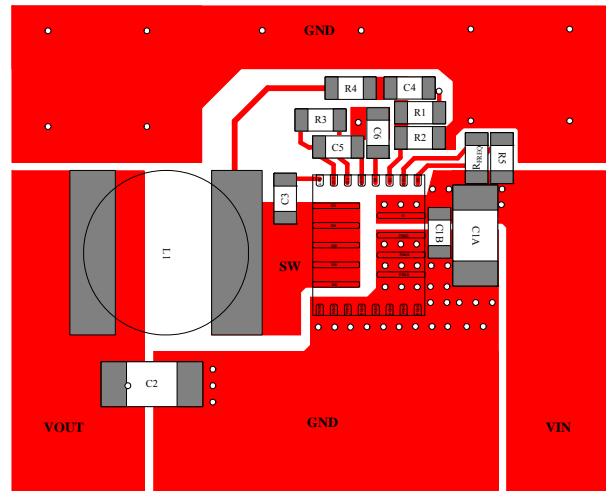
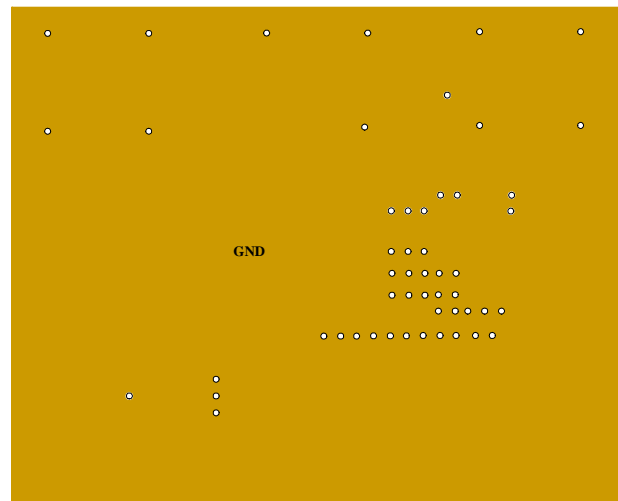

Figure 12—Schematic for PCB Layout Guide



Top Layer



Inner1 Layer

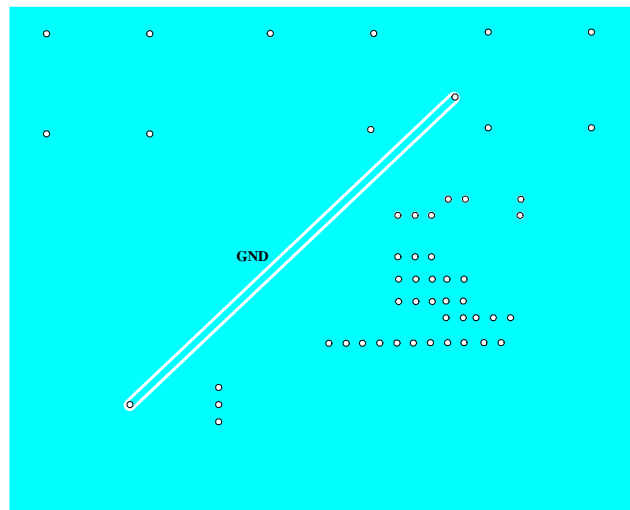

Inner2 Layer

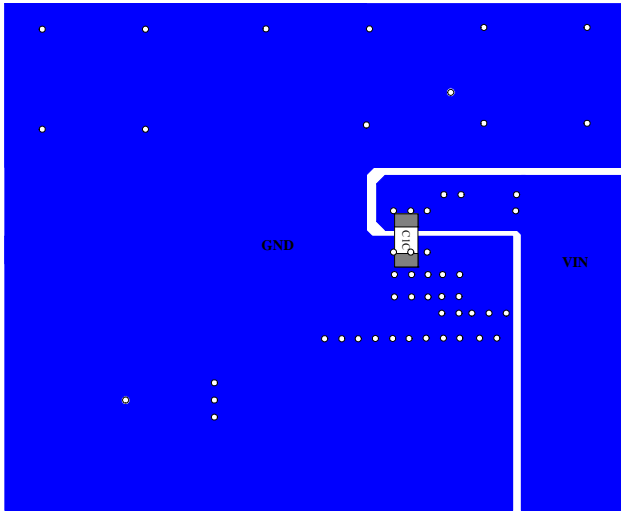

Bottom Layer

Figure 13—PCB Layout Guide for 25-Pin QFN Package

Design Example

Below is a design example following the application guidelines for the specifications:

Table 5: Design Example

V_{IN}	4.5-18V
V_{OUT}	1V
f_{SW}	500kHz

The detailed application schematic is shown in Figure 11. The typical performance and circuit waveforms have been shown in the Typical Performance Characteristics section. For more device applications, please refer to the related Evaluation Board Datasheets.

PACKAGE INFORMATION

25-Pin QFN(5×4mm)

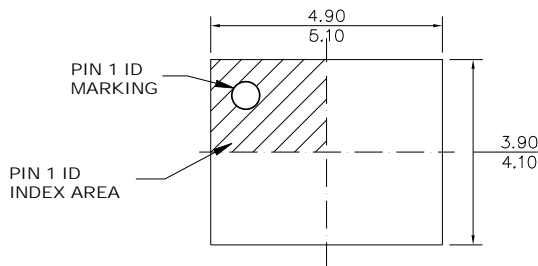

TOP VIEW

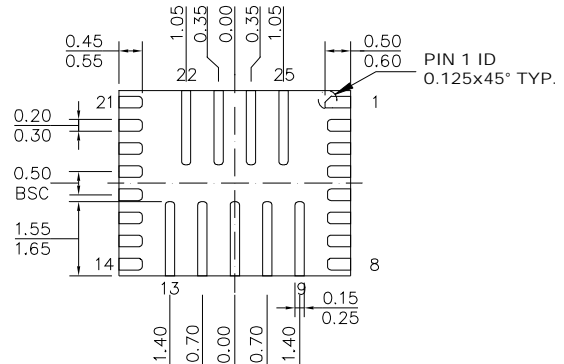

BOTTOM VIEW

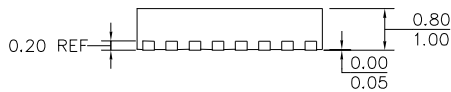

SIDE VIEW

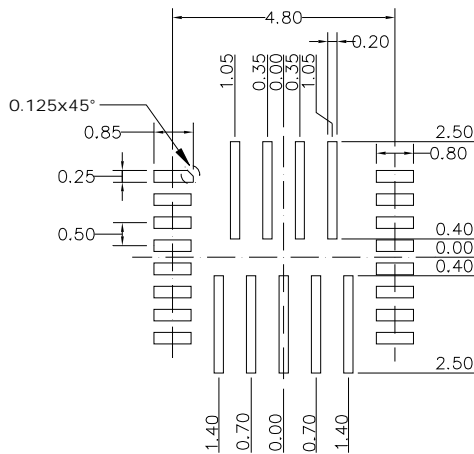

RECOMMENDED LAND PATTERN

NOTE:

- 1) ALL DIMENSIONS ARE IN MILLIMETERS.
- 2) EXPOSED PADDLE SIZE DOES NOT INCLUDE MOLD FLASH.
- 3) LEAD COPLANARITY SHALL BE 0.10 MILLIMETERS MAX.
- 4) JEDEC REFERENCE IS MO-220.
- 5) DRAWING IS NOT TO SCALE.

NOTICE: The information in this document is subject to change without notice. Users should warrant and guarantee that third party Intellectual Property rights are not infringed upon when integrating MPS products into any application. MPS will not assume any legal responsibility for any said applications.