

### DESCRIPTION

The MPM3810 is a step-down module converter with built-in power MOSFETs and inductor. The module's integrated inductor simplifies the power system design and provides easy, efficient use. The DC-DC module comes in a small surface-mount QFN-12 (2.5mmx3.0mmx0.9mm) package and achieves 1.2A peak output current from a 2.5V to 6V input voltage with excellent load and line regulation. The output voltage is regulated as low as 0.6V. For adjustable output, only FB resistors and input and output capacitors are needed to complete the design.

The constant-on-time control (COT) scheme provides fast, transient response and eases loop stabilization. Fault condition protection includes cycle-by-cycle current limiting and thermal shutdown (TSD).

The MPM3810 is ideal for a wide range of applications including high-performance DSPs, FPGAs, PDAs, portable instruments, and storage.

### FEATURES

- Wide 2.5V to 6V Operating Input Range
- Fixed and Adjustable Output from 0.6V
- QFN-12 (2.5mmx3.0mmx0.9mm) Package
- Total Solution Size 6mm x 3.8mm
- Up to 1.2A Peak Output Current
- 100% Duty Cycle in Dropout
- Ultra Low IQ: 17µA
- EN and Power Good for Power Sequencing
- Cycle-by-Cycle Over-Current Protection
- Short-Circuit Protection with Hiccup Mode
- Adjustable Output Only Needs 4 External Components: 2 Ceramic Capacitors and FB Divider Resistors
- Fixed Output Only Needs Input and Output Capacitors

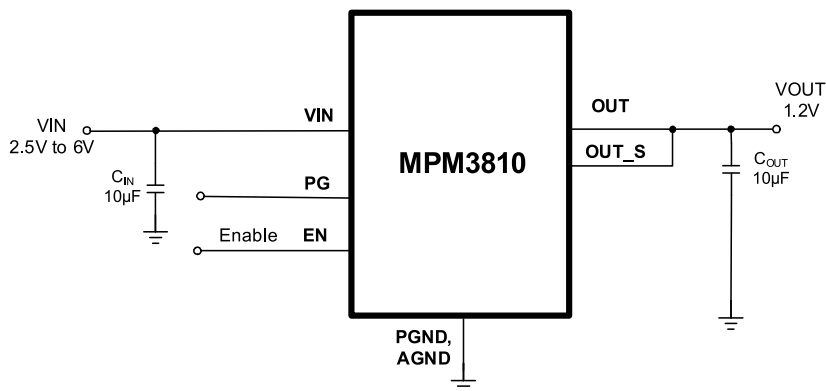
### APPLICATIONS

- Low Voltage I/O System Power
- LDO Replacement
- Power for Portable Products
- Storage (SSD/HDD)
- Space-Limited Applications

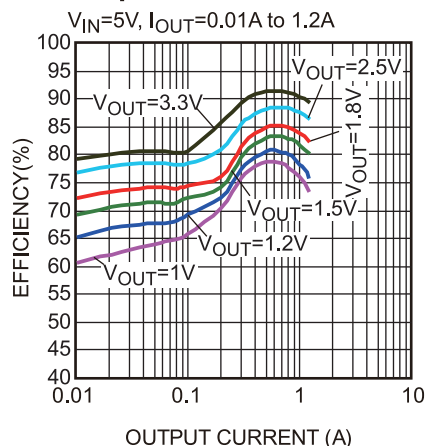
All MPS parts are lead-free and adhere to the RoHS directive. For MPS green status, please visit MPS website under Products, Quality Assurance page.

"MPS" and "The Future of Analog IC Technology" are Registered Trademarks of Monolithic Power Systems, Inc.

### TYPICAL APPLICATION (Fixed Output)



### Efficiency vs. Output Current



### ORDERING INFORMATION

Part Number	Package	Top Marking	Vo Range
MPM3810GQB*	QFN-12 (2.5mmX3.0mmX0.9mm).	AEZ	Adjustable
MPM3810GQB-12	QFN-12 (2.5mmX3.0mmX0.9mm).	AGX	Fixed 1.2V
MPM3810GQB-18	QFN-12 (2.5mmX3.0mmX0.9mm).	AGZ	Fixed 1.8V
MPM3810GQB-25	QFN-12 (2.5mmX3.0mmX0.9mm).	AJG	Fixed 2.5V
MPM3810GQB-33	QFN-12 (2.5mmX3.0mmX0.9mm).	AJH	Fixed 3.3V

\* For Tape & Reel, add suffix –Z (e.g. MPM3810GQB–Z);

### PACKAGE REFERENCE

MPM3810GQB	MPM3810GQB-12 MPM3810GQB-25 MPM3810GQB-18 MPM3810GQB-33
<b>QFN-12 (2.5mmX3.0mmX0.9mm).</b>	

#### Absolute Maximum Ratings <sup>(1)</sup>

Supply Voltage $V_{IN}$ .....	6.5V
$V_{SW}$ .....	-0.3V (-5V for <10ns) to 6.5V (7V for <10ns)
All Other Pins.....	-0.3V to 6.5 V
Junction Temperature .....	150°C
Lead Temperature .....	260°C
Continuous Power Dissipation ( $T_A = +25^\circ\text{C}$ ) <sup>(2)</sup> .....	1.9W
Storage Temperature.....	-65°C to +150°C

#### Recommended Operating Conditions <sup>(3)</sup>

Supply Voltage $V_{IN}$ .....	2.5V to 6V
Output Voltage $V_{OUT}$ .....	12% x $V_{IN}$ to $V_{IN}$
Operating Junction Temp. ( $T_J$ ). .....	-40°C to +125°C

#### Thermal Resistance <sup>(4)</sup> $\theta_{JA}$ $\theta_{JC}$

QFN-12 (2.5mmX3.0mm).....	65	13	°C/W
---------------------------	----	----	------

#### Notes:

- Exceeding these ratings may damage the device.
- The maximum allowable power dissipation is a function of the maximum junction temperature  $T_J$  (MAX), the junction-to-ambient thermal resistance  $\theta_{JA}$ , and the ambient temperature  $T_A$ . The maximum allowable continuous power dissipation at any ambient temperature is calculated by  $P_D$  (MAX) =  $(T_J$  (MAX) -  $T_A$ ) /  $\theta_{JA}$ . Exceeding the maximum allowable power dissipation will cause excessive die temperature, and the regulator will go into thermal shutdown. Internal thermal shutdown circuitry protects the device from permanent damage.
- The device is not guaranteed to function outside of its operating conditions.
- Measured on JESD51-7, 4-layer PCB.

## ELECTRICAL CHARACTERISTICS

$V_{IN} = 5V$ ,  $T_J = -40^{\circ}C$  to  $+125^{\circ}C$ , Typical value is tested at  $T_J = +25^{\circ}C$ . The limit over temperature is guaranteed by characterization, unless otherwise noted.

Parameter	Symbol	Condition	Min	Typ	Max	Units
Feedback Voltage (MPM3810GQB Only)	$V_{FB}$	$2.5V \leq V_{IN} \leq 6V$ , $T_J = +25^{\circ}C$	588	600	612	mV
Fixed Output Voltage		Only for MPM3810GQB-12, $I_{OUT} = 10mA$ , $T_J = +25^{\circ}C$	1.17	1.2	1.23	V
		Only for MPM3810GQB-18, $I_{OUT} = 10mA$ , $T_J = +25^{\circ}C$	1.755	1.8	1.845	
		Only for MPM3810GQB-25, $I_{OUT} = 10mA$ , $T_J = +25^{\circ}C$	2.437	2.5	2.563	
		Only for MPM3810GQB-33, $I_{OUT} = 10mA$ , $T_J = +25^{\circ}C$	3.217	3.3	3.383	
Feedback Current	$I_{FB}$	$V_{FB} = 0.63V$ , Only for MPM3810GQB		10		nA
PFET Switch-On Resistance	$R_{DSON\ P}$			100		m $\Omega$
NFET Switch-On Resistance	$R_{DSON\ N}$			60		m $\Omega$
Inductor L Value	L	Inductance value at 1MHz		0.47		$\mu H$
Inductor DC Resistance	$R_{DCR}$			120		m $\Omega$
Dropout Resistance	$R_{DR}$	100% on duty		220		m $\Omega$
Switch Leakage		$V_{EN} = 0V$ , $V_{IN} = 6V$ $V_{SW} = 0V$ and $6V$ , $T_J = +25^{\circ}C$		0	1	$\mu A$
PFET Current Limit			1.6	2.1	2.6	A
On Time	$T_{ON}$	$V_{IN} = 5V$ , $V_{OUT} = 1.2V$		70		ns
		$V_{IN} = 3.6V$ , $V_{OUT} = 1.2V$		100		
Switching Frequency	$F_s$	$V_{IN} = 3.6V$ , $V_{OUT} = 1.2V$	2800	3500	4200	kHz
Minimum Off Time	$T_{MIN-OFF}$			60		ns
Soft-Start Time	$T_{SS-ON}$			1.5		ms
Power Good Upper Trip Threshold	$PG_H$	FB Voltage in Respect to the Regulation		+10		%
Power Good Lower Trip Threshold	$PG_L$			-10		%
Power Good Delay	$PG_D$			50		$\mu s$
Power Good Sink Current Capability	$V_{PG-L}$	Sink 1mA			0.4	V
Power Good Logic High Voltage	$V_{PG-H}$	$V_{IN} = 5V$ , $V_{FB} = 0.6V$	4.9			V
Power Good Internal Pull-Up Resistor	$R_{PG}$			550		k $\Omega$

**ELECTRICAL CHARACTERISTICS (continued)**

$V_{IN} = 5V$ ,  $T_J = -40^{\circ}C$  to  $+125^{\circ}C$ , Typical value is tested at  $T_J = +25^{\circ}C$ . The limit over temperature is guaranteed by characterization, unless otherwise noted.

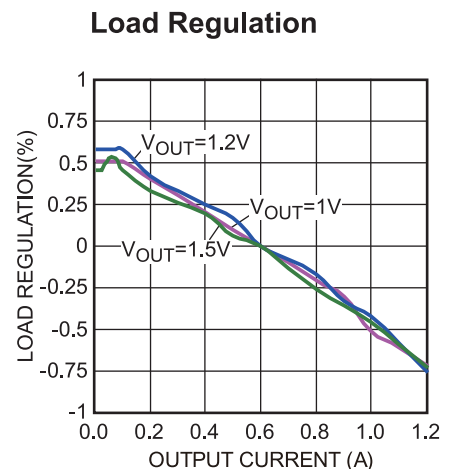
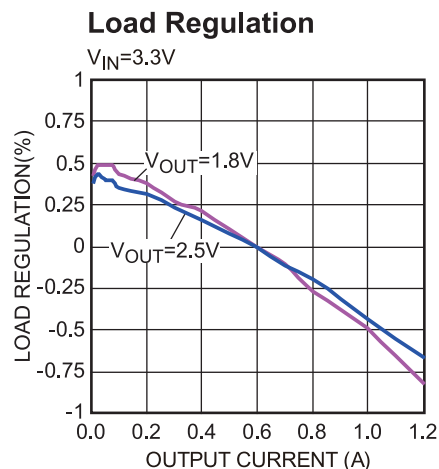
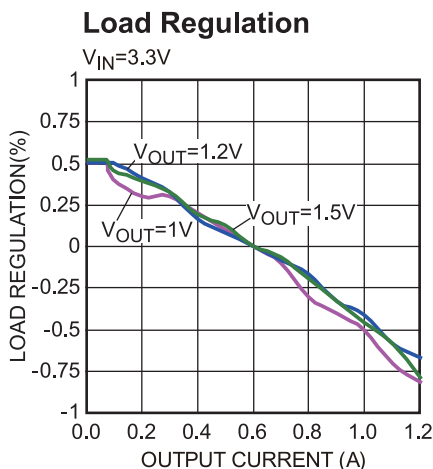
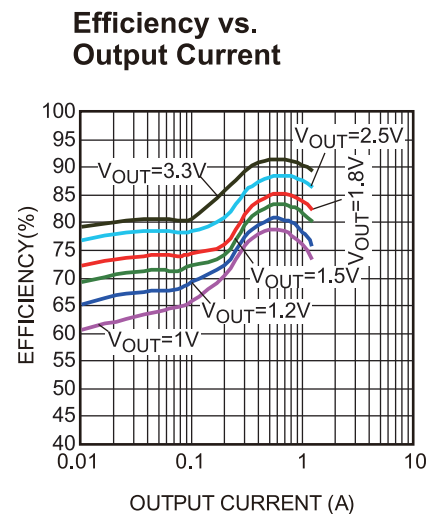
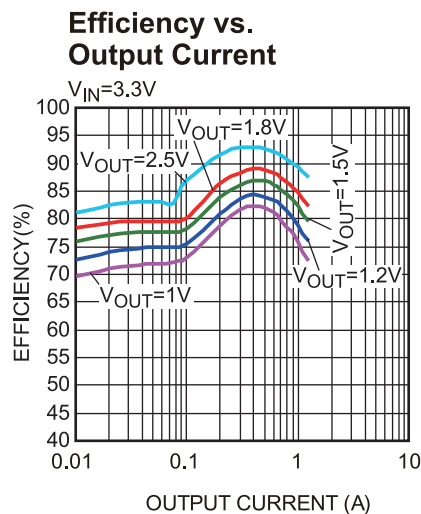
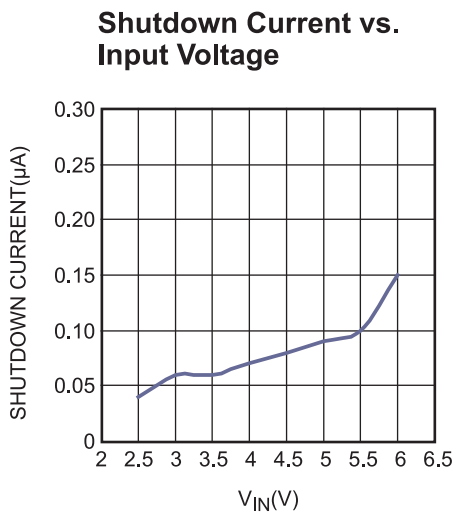
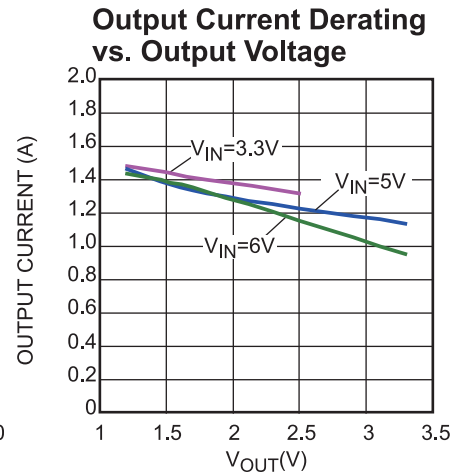
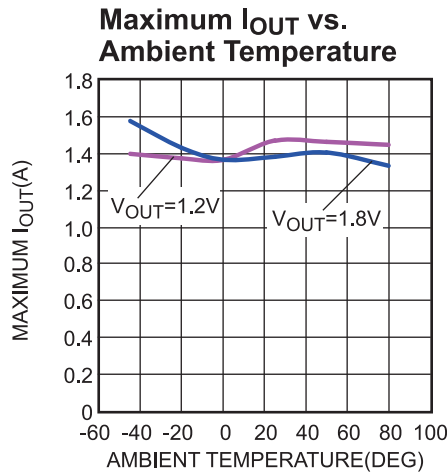
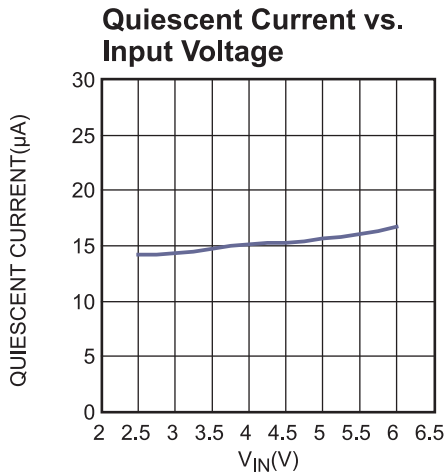
Parameter	Symbol	Condition	Min	Typ	Max	Units
Under-Voltage Lockout Threshold Rising			2.15	2.3	2.48	V
Under-Voltage Lockout Threshold Hysteresis				300		mV
EN Input Logic Low Voltage					0.4	V
EN Input Logic High Voltage			1.2			V
EN Input Current		$V_{EN}=2V$		1.5		$\mu A$
		$V_{EN}=0V$		0.1	1	$\mu A$
Supply Current (Shutdown)		$V_{EN}=0V$ , $T_J=+25^{\circ}C$			1	$\mu A$
Supply Current (Quiescent)		$V_{EN}=2V$ , $V_{FB}=0.63V$ , $V_{IN}=5V$ , $T_J=+25^{\circ}C$		17	21	$\mu A$
Thermal Shutdown <sup>(5)</sup>				150		$^{\circ}C$
Thermal Hysteresis <sup>(5)</sup>				30		$^{\circ}C$

**Notes:**

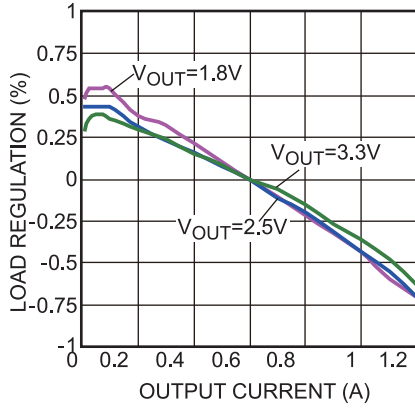
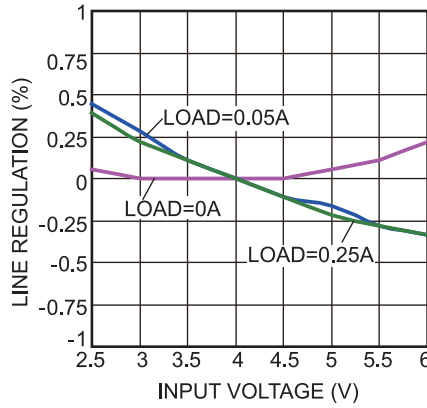
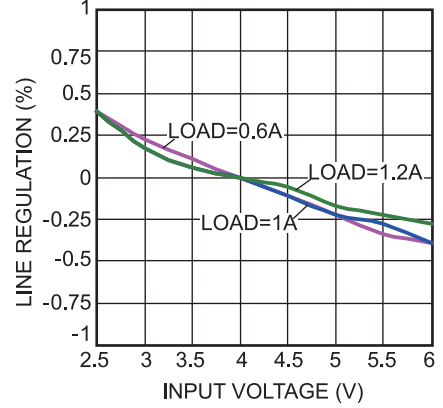
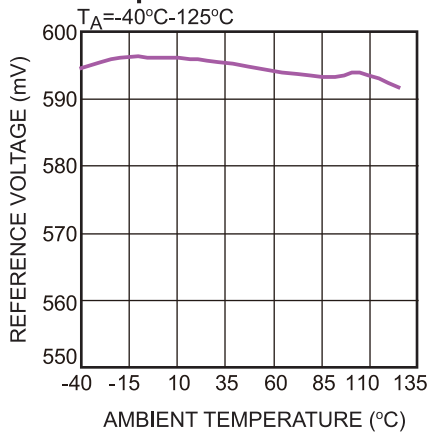
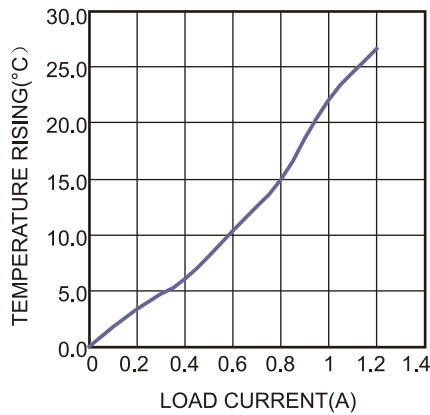
5) Not production test, guaranteed by design.

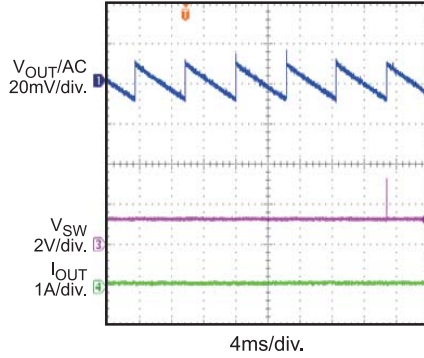
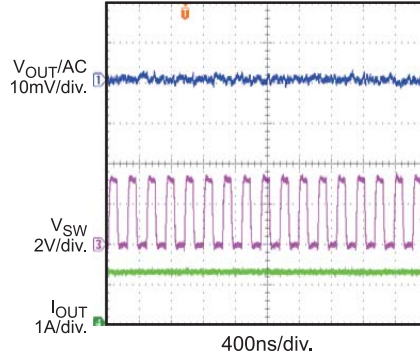
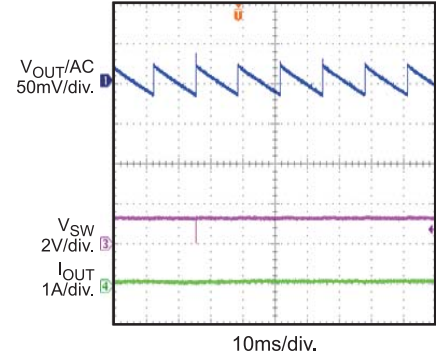
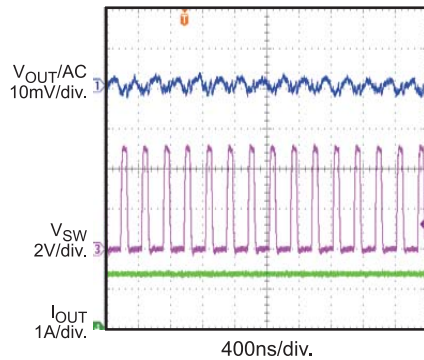
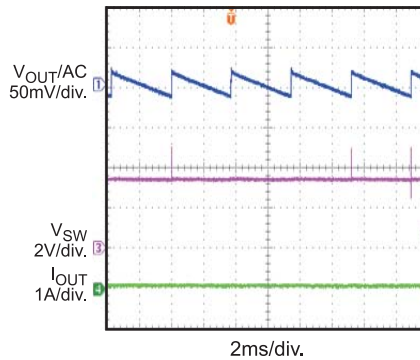
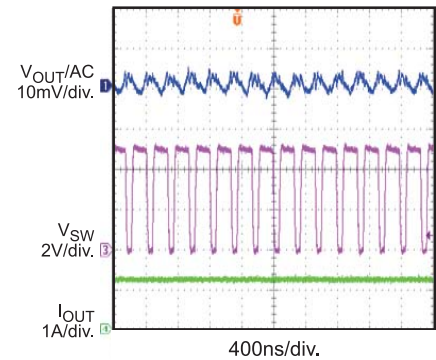
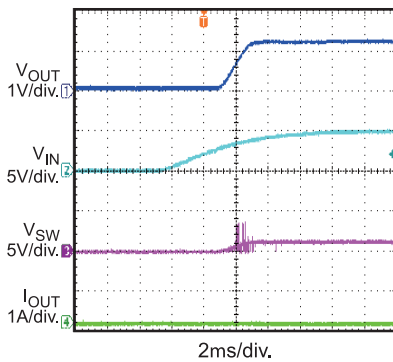
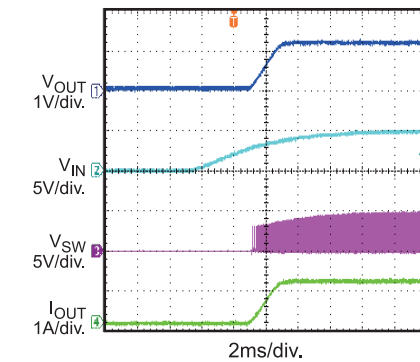
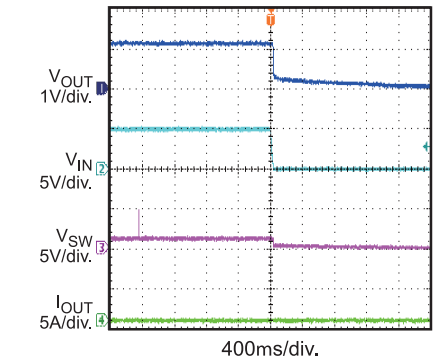
## TYPICAL PERFORMANCE CHARACTERISTICS

$V_{IN} = 5V$ ,  $V_{OUT} = 1.2V$ ,  $C_{IN} = 10\mu F$ ,  $C_{OUT} = 20\mu F$ ,  $T_A = +25^\circ C$ , unless otherwise noted.

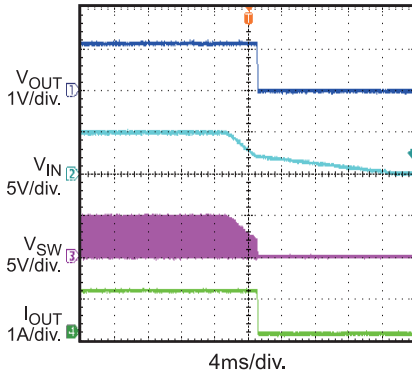
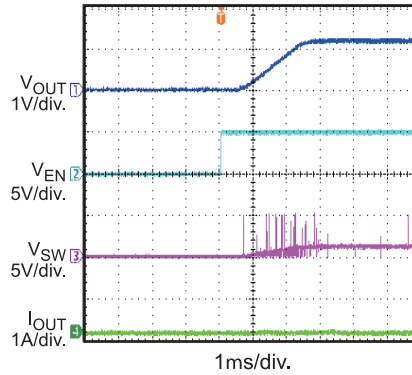
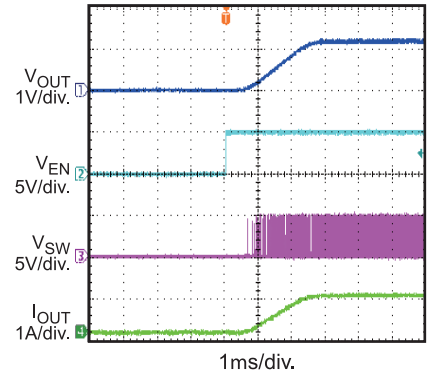
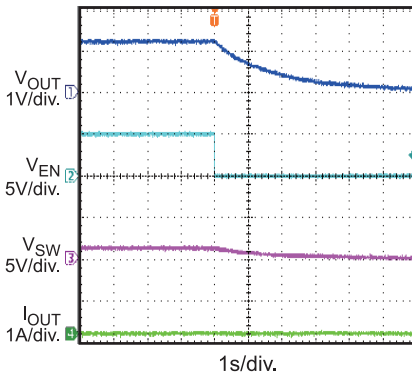
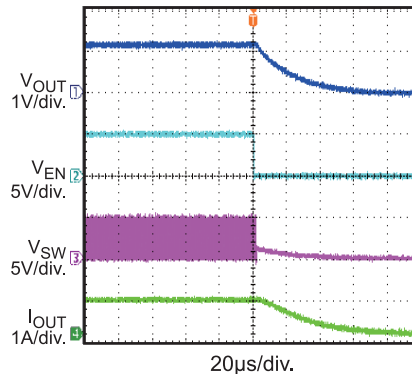
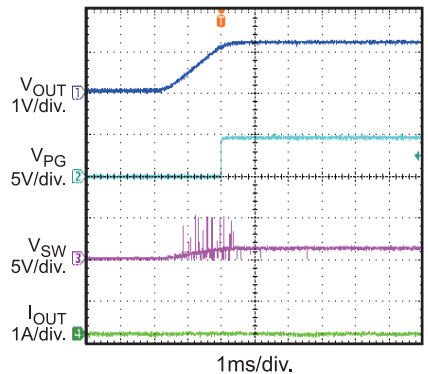
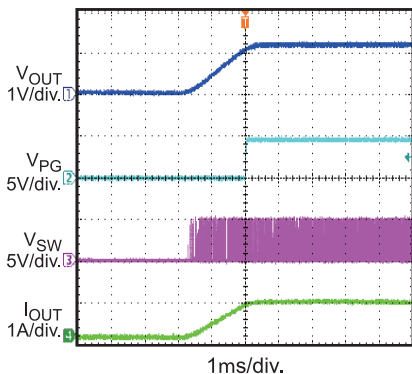
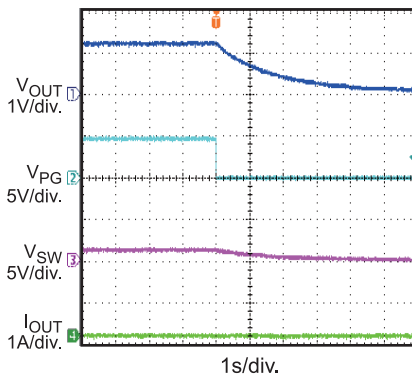
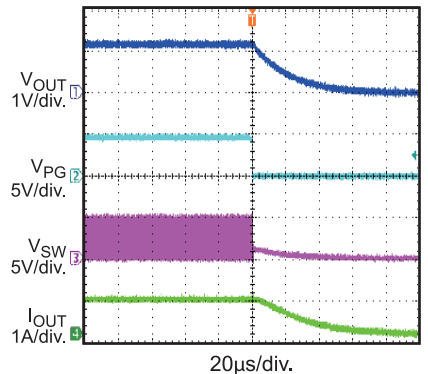


**TYPICAL PERFORMANCE CHARACTERISTICS (continued)**
 $V_{IN} = 5V, V_{OUT} = 1.2V, C_{IN} = 10\mu F, C_{OUT} = 20\mu F, T_A = +25^\circ C$ , unless otherwise noted.

**Load Regulation**

**Line Regulation**

**Line Regulation**

**Reference Voltage vs. Temperature**

**Thermal Rising vs. Load Current.**


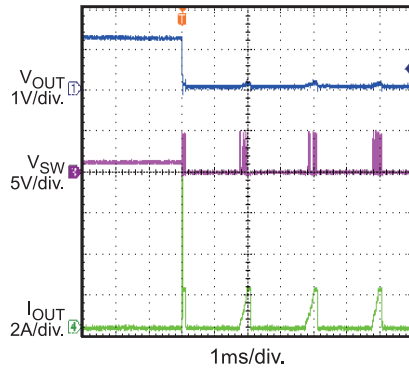
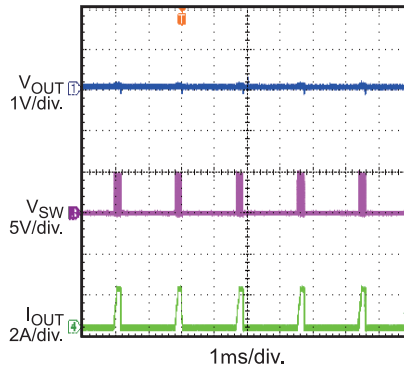
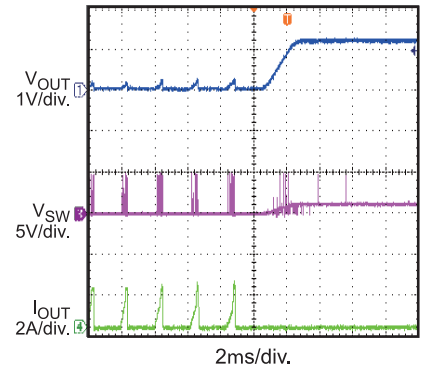
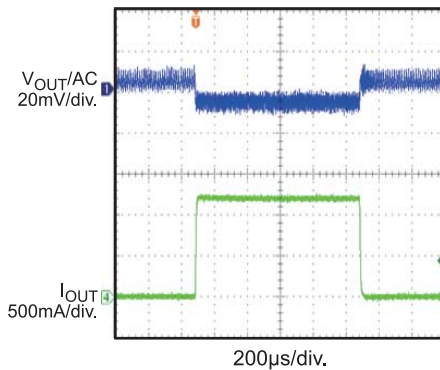
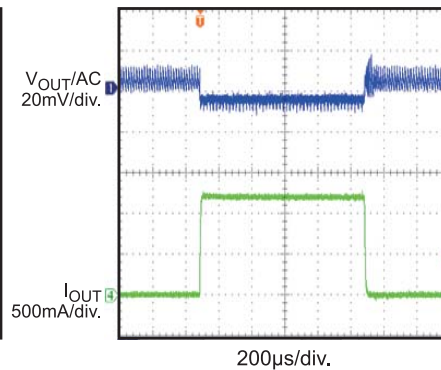
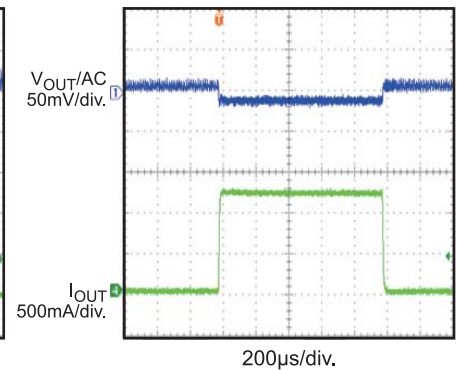
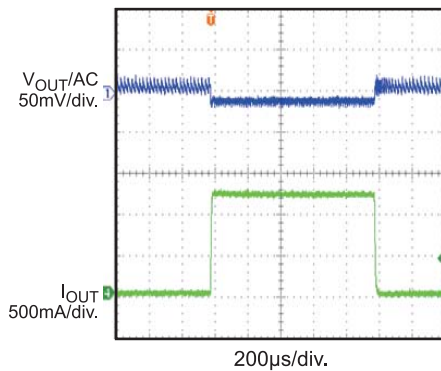
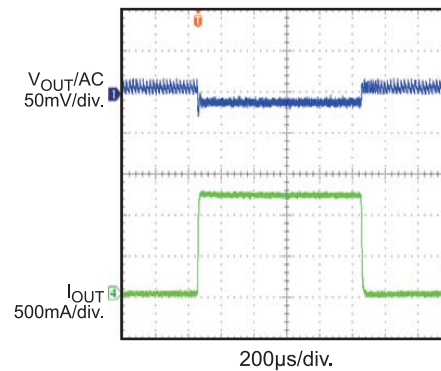
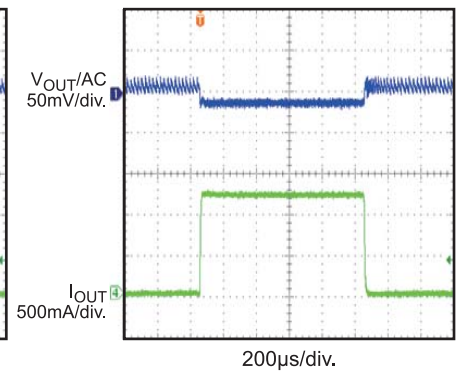
**TYPICAL PERFORMANCE CHARACTERISTICS (continued)**
 **$V_{IN} = 5V$ ,  $V_{OUT} = 1.2V$ ,  $C_{IN}=10\mu F$ ,  $C_{OUT}=20\mu F$ ,  $T_A = +25^\circ C$ , unless otherwise noted.**
**Output Ripple**
 $V_{IN} = 3.3V$ ,  $V_{OUT} = 1.2V$ ,  $I_{OUT}=0A$ 

**Output Ripple**
 $V_{IN} = 3.3V$ ,  $V_{OUT} = 1.2V$ ,  $I_{OUT}=1.2A$ 

**Output Ripple**
 $V_{IN} = 5V$ ,  $V_{OUT} = 1.2V$ ,  $I_{OUT}=0A$ 

**Output Ripple**
 $V_{IN} = 5V$ ,  $V_{OUT} = 1.2V$ ,  $I_{OUT}=1.2A$ 

**Output Ripple**
 $V_{IN} = 5V$ ,  $V_{OUT} = 3.3V$ ,  $I_{OUT}=0A$ 

**Output Ripple**
 $V_{IN} = 5V$ ,  $V_{OUT} = 3.3V$ ,  $I_{OUT}=1.2A$ 

 **$V_{IN}$  Power Up  
without Load**

 **$V_{IN}$  Power Up  
with 1A Load**

 **$V_{IN}$  Shutdown  
without Load**


**TYPICAL PERFORMANCE CHARACTERISTICS (continued)**
 $V_{IN} = 5V, V_{OUT} = 1.2V, C_{IN} = 10\mu F, C_{OUT} = 20\mu F, T_A = +25^\circ C$ , unless otherwise noted.

 **$V_{IN}$  Shutdown with 1A Load**

**EN Startup without Load**

**EN Startup with 1A Load**

**EN Shutdown without Load**

**EN Shutdown with 1A Load**

**Power Good On without Load**

**Power Good On with 1A Load**

**Power Good Off without Load**

**Power Good Off with 1A Load**




**TYPICAL PERFORMANCE CHARACTERISTICS (continued)**
 $V_{IN} = 5V, V_{OUT} = 1.2V, C_{IN} = 10\mu F, C_{OUT} = 20\mu F, T_A = +25^\circ C$ , unless otherwise noted.

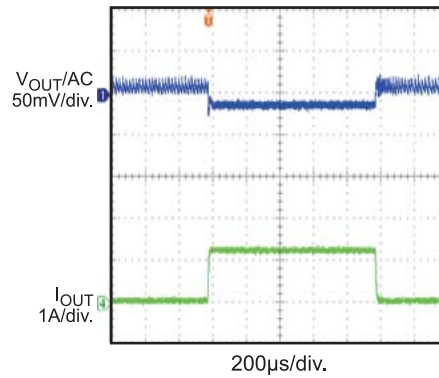
**Short-Circuit Entry**

**Short Circuit**

**Short-Circuit Recovery**

**Transient Response**
 $V_{IN} = 3.3V, V_{OUT} = 1V, I_{OUT} = 0A-1.2A, 0.25A/\mu s$ 

**Transient Response**
 $V_{IN} = 5V, V_{OUT} = 1V, I_{OUT} = 0A-1.2A, 0.25A/\mu s$ 

**Transient Response**
 $V_{IN} = 3.3V, V_{OUT} = 1.8V, I_{OUT} = 0A-1.2A, 0.25A/\mu s$ 

**Transient Response**
 $V_{IN} = 5V, V_{OUT} = 1.8V, I_{OUT} = 0A-1.2A, 0.25A/\mu s$ 

**Transient Response**
 $V_{IN} = 3.3V, V_{OUT} = 2.5V, I_{OUT} = 0A-1.2A, 0.25A/\mu s$ 

**Transient Response**
 $V_{IN} = 5V, V_{OUT} = 2.5V, I_{OUT} = 0A-1.2A, 0.25A/\mu s$ 


## TYPICAL PERFORMANCE CHARACTERISTICS *(continued)*

$V_{IN} = 5V$ ,  $V_{OUT} = 1.2V$ ,  $C_{IN} = 10\mu F$ ,  $C_{OUT} = 20\mu F$ ,  $T_A = +25^\circ C$ , unless otherwise noted.

### Transient Response

$V_{IN} = 5V$ ,  $V_{OUT} = 3.3V$ ,  
 $I_{OUT} = 0A - 0.6A$ ,  $0.25A/\mu s$



## PIN FUNCTIONS

Pin #	Name	Description
1, 2	PGND	Power Ground.
3, 4	NC	Internal SW Pad. Connected with copper pad for thermal sink.
5, 6	OUT	Output Voltage Power Rail. Connect load to OUT. Output capacitor is needed.
7	VIN	Supply Voltage. The MPM3810 operates from a +2.5V to +6V unregulated input. A decouple capacitor is needed to prevent large voltage spikes from appearing at the input. Place the decoupling capacitor as close to VIN as possible.
8	PG	Power Good Indicator. The output of PG is an open drain with an internal pull-up resistor to VIN. PG is pulled up to VIN when the FB voltage is within 10% of the regulation level. If FB voltage is out of that regulation range, PG is low.
9	EN	On/Off Control.
10	FB (MPM3810GQB only)	Feedback. An external resistor divider from the output to GND (tapped to the FB) sets the output voltage.
	NC (Fixed Output Version only)	Inter Test Pad. Do Not Connect.
11	AGND	Analogy Ground for Internal Control Circuit.
12	OUT_S	Output Voltage Sense.

## OPERATION

The DC-DC module has a small surface-mount QFN-12 (2.5mmx3.0mmx0.9mm) package. The module's integrated inductor simplifies the schematic and layout design. Only FB resistors and input and output capacitors are needed to complete the design. MPM3810 uses constant on-time control (COT) with input voltage feed forward to stabilize the switching frequency over a full-input range. At light load, MPM3810 employs a proprietary control of the low-side switch and inductor current to improve efficiency.

### Constant On-Time Control (COT)

Compared to a fixed-frequency PWM control, constant on-time control (COT) offers the advantage of a simpler control loop and faster transient response. Using input voltage feed forward, the MPM3810 maintains a nearly constant switching frequency across the input and output voltage range. The on-time of the switching pulse is estimated as follows:

$$T_{ON} = \frac{V_{OUT}}{V_{IN}} \cdot 0.28\mu s$$

To prevent inductor current run away during load transition, MPM3810 fixes the minimum off time to 60ns. However, this minimum off-time limit does not affect operation in a steady state.

### Light-Load Operation

In a light-load condition, MPM3810 uses a proprietary control scheme to save power and improve efficiency. The MP3810 turns off the low-side switch when the inductor current begins to reverse. Then MP3810 works in discontinuous conduction mode (DCM) operation.

A zero current cross circuit detects if the inductor current begins to reverse. Considering the internal circuit propagation time, the typical delay time is 30ns. This means the inductor current continues to fall after the ZCD is triggered. If the inductor current falling slew rate is fast ( $V_o$  voltage is high or close to  $V_{in}$ ), the low-side MOSFET turns off (this means the inductor current may be negative). This does not allow the MPM3810 to enter DCM. If DCM is required, the off-time of the low-side MOSFET in continuous conduction mode (CCM) should be longer than 60ns. For example, if  $V_{in}$  is 3.6V and  $V_o$  is 3.3V,

the off-time in CCM is 24ns. It is difficult to enter DCM at light load.

### Enable (EN)

If the input voltage is greater than the under-voltage lockout threshold (UVLO), typically 2.3V, MPM3810 is enabled by pulling EN above 1.2V. Leaving EN to float or be pulled down to ground disables MPM3810. There is an internal 1M $\Omega$  resistor from EN to ground.

### Soft-Start (SS)

MPM3810 has a built-in soft-start that ramps up the output voltage in a controlled slew rate. This avoids overshoot at startup. The soft-start time is about 1.5ms typically.

### Power GOOD Indicator (PGOOD)

MPM3810 has an open drain with a 550k $\Omega$  pull-up resistor pin for the power good indicator (PGOOD). When FB is within +/-10% of regulation voltage (i.e. 0.6V), PGOOD is pulled up to IN by the internal resistor. If FB voltage is out of the +/-10% window, PGOOD is pulled down to ground by an internal MOSFET. The MOSFET has a maximum  $R_{ds(on)}$  of less than 400 $\Omega$ .

### Current Limit

MPM3810 has a typical 2.1A current limit for the high-side switch. When the high-side switch reaches the current limit, MPM3810 hits the hiccup threshold until the current decreases. This prevents the inductor current from continuing to build, which results in damage to the components.

### Short Circuit and Recovery

MPM3810 enters short-circuit protection (SCP) mode when the current limit is reached; then it tries to recover from the short circuit with hiccup mode. In SCP, MPM3810 disables the output power stage, discharges the soft-start cap and then automatically tries to soft-start again. If the short circuit remains after the soft-start ends, MPM3810 repeats the cycle until the short circuit disappears, and the output rises back to the regulation level.

## FUNCTIONAL BLOCK DIAGRAM

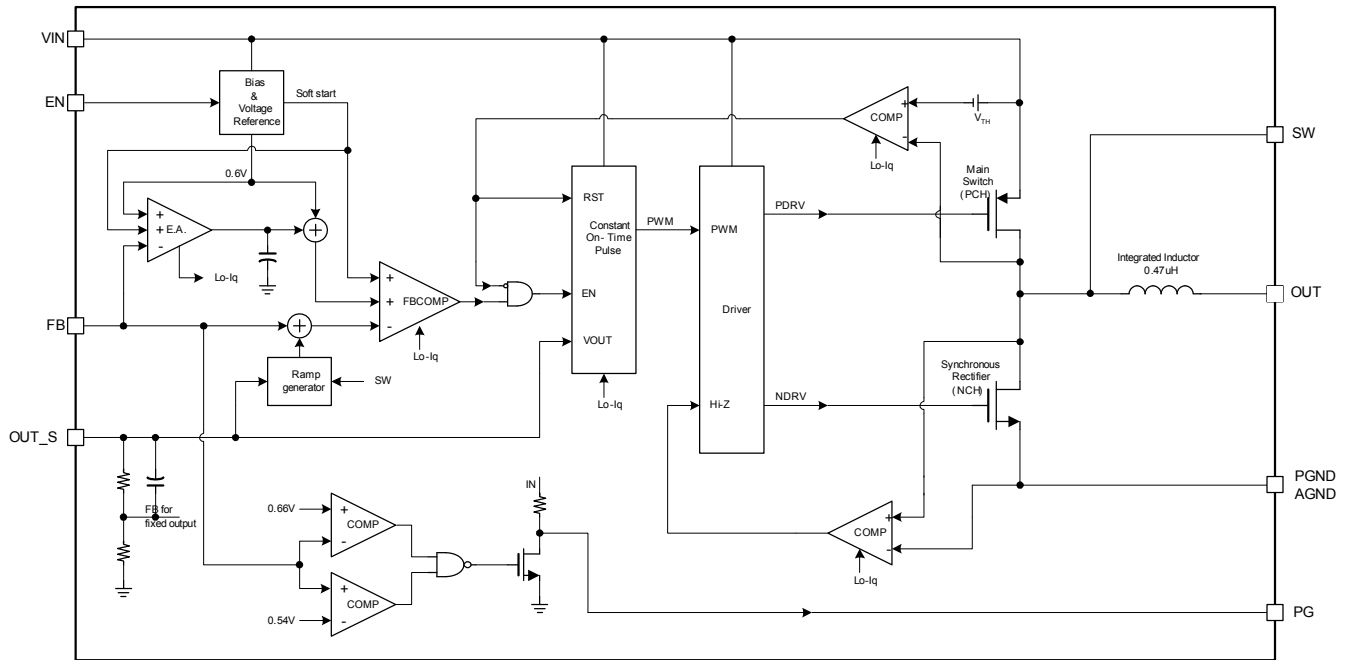


Figure 1: Functional Block Diagram

## APPLICATION INFORMATION

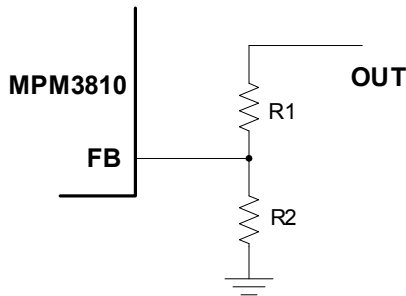
### COMPONENT SELECTION

#### Setting the Output Voltage

The external resistor divider is used to set the output voltage (see Typical Application on page 16). The feedback resistor R1 cannot be too large or too small considering the trade-off for stability and dynamics. Choose R1 between 40kΩ to 80kΩ. R2 is given by:

$$R2 = \frac{R1}{\frac{V_{out}}{0.6} - 1}$$

The feedback circuit is shown in Figure 2.



**Figure 2: Feedback Network**

Table 1 lists the recommended resistor values for common output voltages.

**Table 1: Resistor Values for Common Output Voltages**

V <sub>OUT</sub> (V)	R1 (kΩ)	R2 (kΩ)
1.0	40(1%)	60(1%)
1.2	40(1%)	40(1%)
1.8	60(1%)	30(1%)
2.5	80(1%)	25(1%)
3.3	80(1%)	17.7(1%)

#### Selecting the Input Capacitor

The input current to the step-down converter is discontinuous, therefore a capacitor is required to supply the AC current while maintaining the DC input voltage. For optimal performance, use low ESR capacitors. Ceramic capacitors with X5R or X7R dielectrics are highly recommended due to their low ESR and small temperature coefficients. For most applications, a 10μF capacitor is sufficient.

For higher output voltage, a 22μF may be needed to enhance system stability.

Since the input capacitor absorbs the input switching current, it requires an adequate ripple-current rating. The RMS current in the input capacitor can be estimated by:

$$I_{C1} = I_{LOAD} \times \sqrt{\frac{V_{OUT}}{V_{IN}} \times \left(1 - \frac{V_{OUT}}{V_{IN}}\right)}$$

The worst case condition occurs at V<sub>IN</sub> = 2V<sub>OUT</sub>, where:

$$I_{C1} = \frac{I_{LOAD}}{2}$$

For simplification, choose the input capacitor that has a RMS current rating greater than half of the maximum load current.

The input capacitor can be electrolytic, tantalum or ceramic. When using electrolytic or tantalum capacitors, a small, high quality ceramic capacitor (i.e. 0.1μF), should be placed as close to the IC as possible. When using ceramic capacitors, check that they have enough capacitance to provide sufficient charge to prevent an excessive voltage ripple at input. The input-voltage ripple caused by capacitance is estimated by:

$$\Delta V_{IN} = \frac{I_{LOAD}}{f_s \times C1} \times \frac{V_{OUT}}{V_{IN}} \times \left(1 - \frac{V_{OUT}}{V_{IN}}\right)$$

#### Selecting the Output Capacitor

The output capacitor (C<sub>OUT</sub>) is required to maintain the DC output voltage. Ceramic capacitors are recommended. Low ESR capacitors are preferred to keep the output-voltage ripple low. The output voltage ripple is estimated by:

$$\Delta V_{OUT} = \frac{V_{OUT}}{f_s \times L_1} \times \left(1 - \frac{V_{OUT}}{V_{IN}}\right) \times \left(R_{ESR} + \frac{1}{8 \times f_s \times C2}\right)$$

Where L<sub>1</sub> is the inductor value, and R<sub>ESR</sub> is the equivalent series resistance (ESR) value of the output capacitor (L<sub>1</sub> is 0.47μH).

When using ceramic capacitors, the impedance at the switching frequency is dominated by the capacitance. The output-voltage ripple is mainly

caused by the capacitance. For simplification, the output-voltage ripple is estimated by:

$$\Delta V_{OUT} = \frac{V_{OUT}}{8 \times f_s^2 \times L_1 \times C_2} \times \left( 1 - \frac{V_{OUT}}{V_{IN}} \right)$$

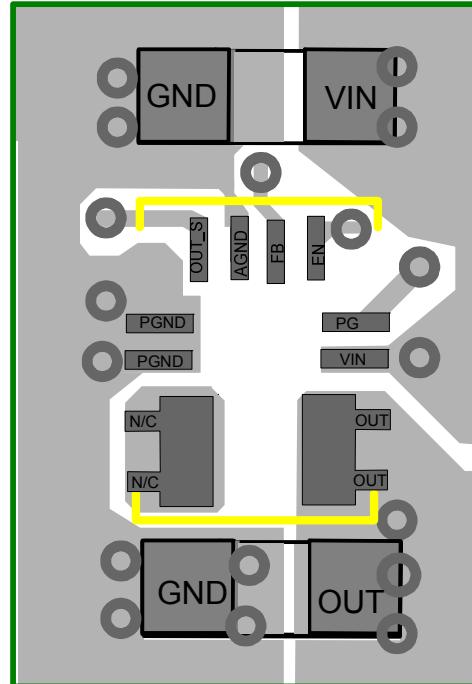
When using tantalum or electrolytic capacitors, the ESR dominates the impedance at the switching frequency. For simplification, the output ripple can be approximated by:

$$\Delta V_{OUT} = \frac{V_{OUT}}{f_s \times L_1} \times \left( 1 - \frac{V_{OUT}}{V_{IN}} \right) \times R_{ESR}$$

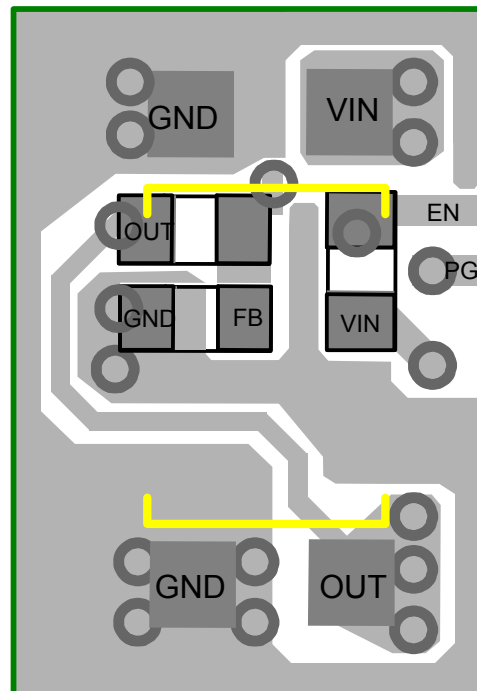
The characteristics of the output capacitor affect the stability of the regulation system.

### PCB Layout

The module's integrated inductor simplifies the schematic and layout design (see Figures 3 and 4). Only FB resistors and input and output capacitors are needed to complete the design. The high-current paths (PGND, IN and OUT) should be placed very close to the device with short, direct, and wide traces. The input capacitor needs to be as close to IN and PGND as possible. The external feedback resistors should be placed next to FB. Keep the switching node away from the feedback network. For additional device applications, please refer to related evaluation board datasheets (EVB).

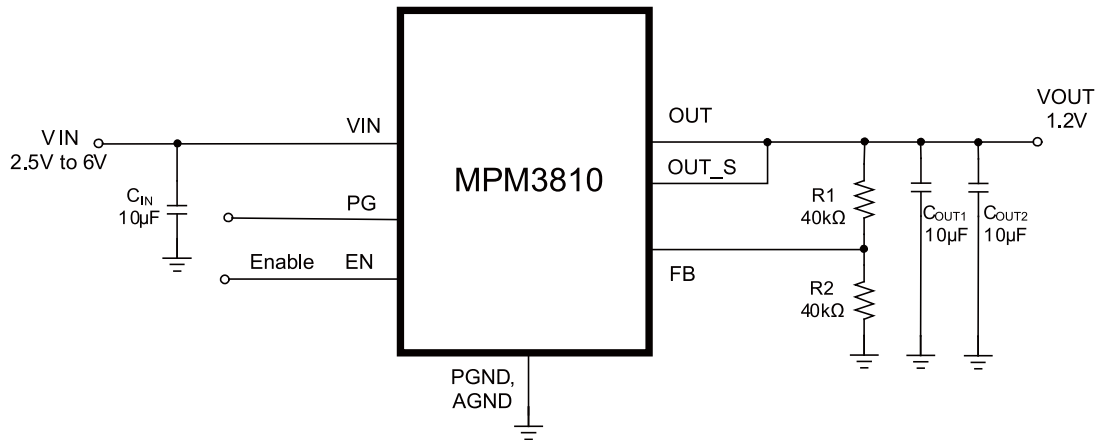


**Figure 3: Top View of Layout Guide**



**Figure 4: Bottom View of Layout Guide**

**TYPICAL APPLICATION CIRCUITS (Adjustable Output)**

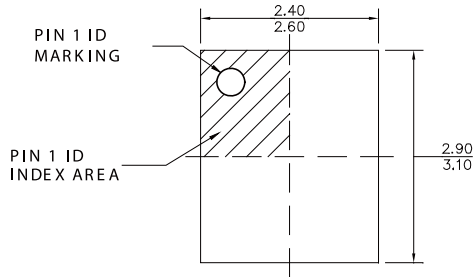


**Figure 5: Typical Application Circuits**

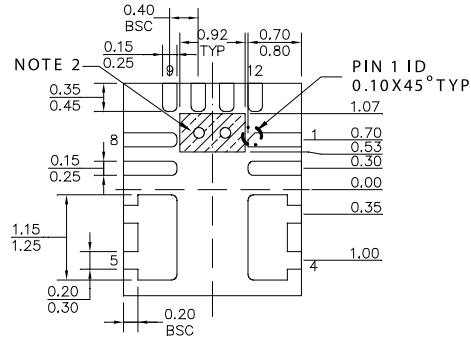


# PACKAGE INFORMATION

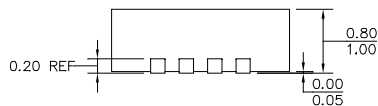
## QFN-12 (2.5mmX3.0mm)



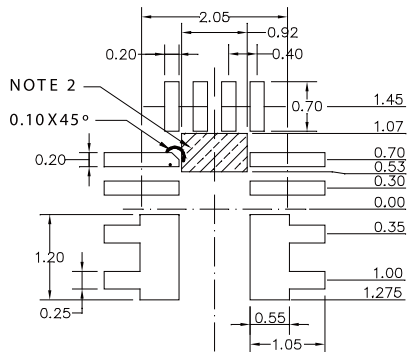
TOP VIEW



BOTTOM VIEW



SIDE VIEW



RECOMMENDED LAND PATTERN

**NOTE:**

- 1) ALL DIMENSIONS ARE IN MILLIMETERS
- 2) SHADED AREA IS THE KEEPOUT ZONE. THE EXPOSED BOTTOM METAL PADS ENCLOSED BY THIS ZONE IS NOT TO BE CONNECTED TO ANY PCB METAL TRACE & VIA ELECTRICALLY OR MECHANICALLY.
- 3) EXPOSED PADDLE SIZE DOES NOT INCLUDE MOLD FLASH.
- 4) LEAD COPLANARITY SHALL BE 0.10 MILLIMETERS MAX.
- 5) JEDEC REFERENCE IS MQ220.
- 6) DRAWING IS NOT TO SCALE

**NOTICE:** The information in this document is subject to change without notice. Please contact MPS for current specifications. Users should warrant and guarantee that third party Intellectual Property rights are not infringed upon when integrating MPS products into any application. MPS will not assume any legal responsibility for any said applications.