



### DESCRIPTION

The MP3383 is a step-up controller with four LED current channels, designed to drive WLED arrays for large LCD panel backlighting applications. The MP3383 can expand the number of LED channels with two or more ICs in parallel sharing a single power source.

The MP3383 employs peak current control mode with a fixed switching frequency ( $f_{sw}$ ) that is configurable via an external setting resistor. The MP3383 drives an external MOSFET to boost up the output voltage ( $V_{OUT}$ ) from a 6V to 33V input voltage ( $V_{IN}$ ) supply. It also regulates the current in each LED string to the value set by an external current-setting resistor.

The MP3383 applies four internal current sources for current balancing. The current matching achieves 1.8% regulation accuracy among strings. The low regulation voltage on the LED current sources reduces power loss.

The MP3383 supports direct pulse-width modulation (PWM) dimming as well as analog dimming using a PWM input. Full protection features include over-current protection (OCP), over-temperature protection (OTP), under-voltage protection (UVP), over-voltage protection (OVP), LED short and open protection, and inductor and diode short protection.

The MP3383 is available in SOIC-16 and TSSOP-16EP packages.

### FEATURES

- 4-String, Max 400mA/String WLED Driver
- 6V to 33V Input Voltage ( $V_{IN}$ ) Range
- 12V Gate Voltage ( $V_{GATE}$ ) ( $V_{IN} > 13V$ )
- 80V Absolute Maximum Rating for Each String
- 1.8% Current Matching Accuracy between Each String
- 3% Current Accuracy
- Direct PWM Dimming
- Analog Dimming Mode with PWM Input
- Cascading Capability with a Single Power Source
- LED Open and Short Protection
- Configurable Recoverable Over-Voltage Protection (OVP)
- Over-Temperature Protection (OTP)
- Short Inductor and Diode Protection
- Available in SOIC-16 and TSSOP-16EP Packages

### APPLICATIONS

- Desktop LCD Flat-Panel Displays
- All-in-One PCs
- 2D and 3D LCD TVs

All MPS parts are lead-free, halogen-free, and adhere to the RoHS directive. For MPS green status, please visit the MPS website under Quality Assurance. "MPS," the MPS logo, and "Simple, Easy Solutions" are trademarks of Monolithic Power Systems, Inc. or its subsidiaries.

TYPICAL APPLICATION

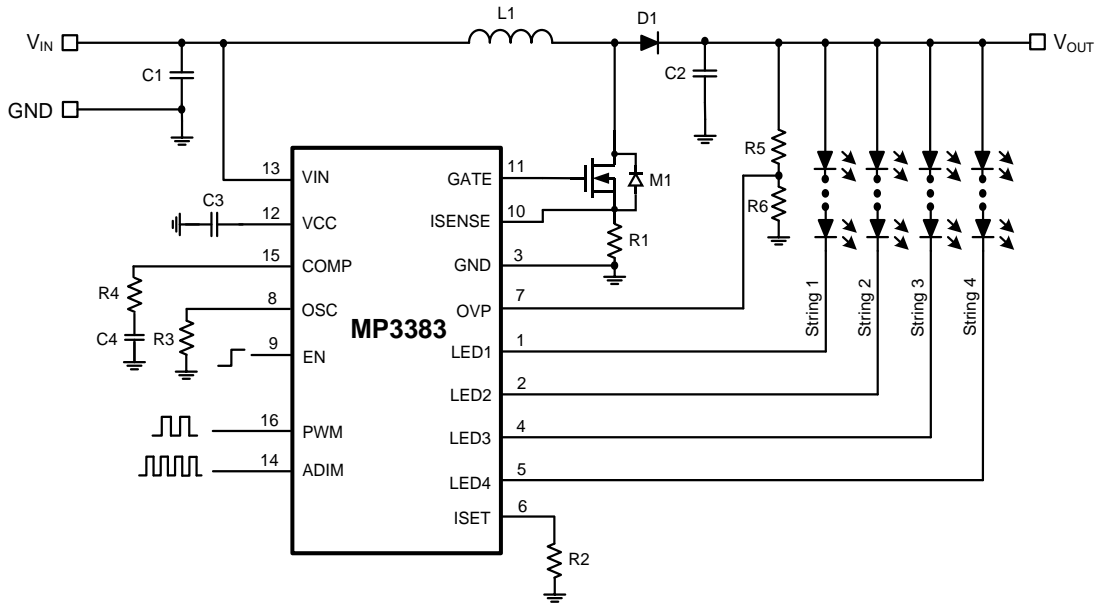

### ORDERING INFORMATION

Part Number*	Package	Top Marking	MSL Rating
MP3383GS*	SOIC-16	See Below	2
MP3383GF**	TSSOP-16EP	See Below	2a

\* For Tape & Reel, add suffix -Z (e.g. MP3383GS-Z). Contact the factory for sample and production.

\*\* For Tape & Reel, add suffix -Z (e.g. MP3383GF-Z).

#### TOP MARKING (MP3383GS)

**MPSYYWW**  
**MP3383**  
**LLLLLLLLL**

MPS: MPS prefix  
 YY: Year code  
 WW: Week code  
 MP3383: Part number  
 LLLLLLLLL: Lot number

#### TOP MARKING (MP3383GF)

**MPSYYWW**  
**MP3383**  
**LLLLLL**

MPS: MPS prefix  
 YY: Year code  
 WW: Week code  
 MP3383: Part number  
 LLLLLL: Lot number

### PACKAGE REFERENCE

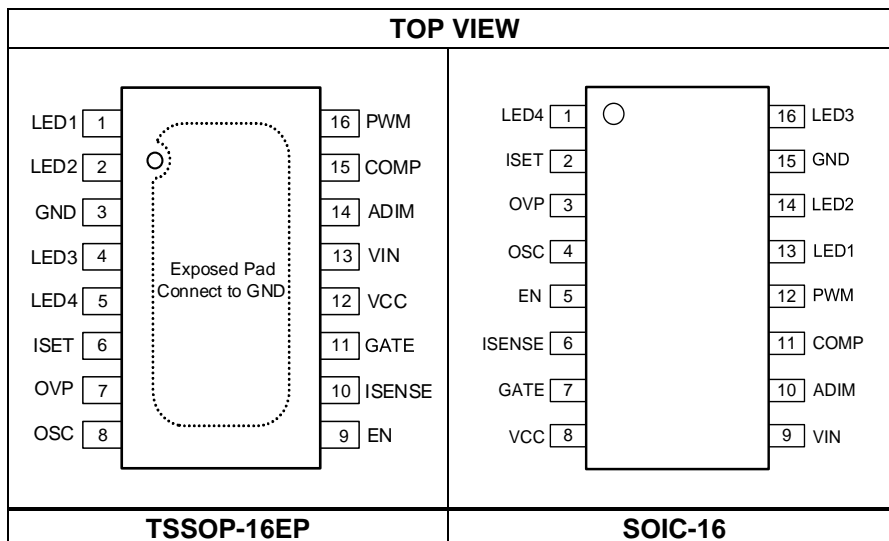

**PIN FUNCTIONS**

TSSOP-16EP Pin #	SOIC-16 Pin #	Name	Description
1	13	LED1	<b>LED string 1 current input.</b> Connect the LED1 pin to the LED string 1 cathode.
2	14	LED2	<b>LED string 2 current input.</b> Connect the LED2 pin to the LED string 2 cathode.
3	15	GND	<b>Ground.</b>
4	16	LED3	<b>LED string 3 current input.</b> Connect the LED3 pin to the LED string 3 cathode.
5	1	LED4	<b>LED string 4 current input.</b> Connect the LED4 pin to the LED string 4 cathode.
6	2	ISET	<b>LED current setting.</b> Connect a current-setting resistor from the ISET pin to GND to configure the current in each LED string.
7	3	OVP	<b>Output over-voltage protection (OVP) setting.</b> Connect a resistor divider from the output to the OVP pin to configure the OVP threshold.
8	4	OSC	<b>Switching frequency (f<sub>sw</sub>) setting.</b> Connect a resistor between the OSC pin and GND to set the step-up converter's f <sub>sw</sub> .
9	5	EN	<b>Enable control input.</b> A voltage exceeding 1.2V turns the part on; a voltage below 0.4V turns the part off. Do not float the EN pin.
10	6	ISENSE	<b>Current-sense input.</b> During normal operation, the ISENSE pin senses the voltage across the external inductor current-sense resistor (R <sub>SENSE</sub> ) for peak current control mode. ISENSE also limits the inductor current (I <sub>L</sub> ) during each switching cycle. For cascading applications, connect the slave IC's ISENSE to GND. Do not float ISENSE.
11	7	GATE	<b>Step-up converter MOSFET driver output.</b> The GATE pin drives the external power N-channel MOSFET.
12	8	VCC	<b>The internal 12V linear regulator output.</b> The VCC pin provides the power supply for the external MOSFET gate driver and the internal control circuitry. Bypass VCC to GND using a ceramic capacitor.
13	9	VIN	<b>Supply input.</b> The VIN pin must be bypassed locally.
14	10	ADIM	<b>Input signal for analog brightness control.</b> The LED current amplitude is determined by the duty cycle of the PWM signal applied to the ADIM pin. An internal RC filter (10MΩ resistor and 100pF capacitor) is integrated into ADIM. A frequency exceeding 20kHz is recommended to achieve better PWM signal filtering performance and ensure that the high-level ADIM voltage (V <sub>ADIM</sub> ) exceeds 1.2V and the low-level V <sub>ADIM</sub> is below 0.4V.
15	11	COMP	<b>Step-up converter compensation.</b> The COMP pin compensates for the regulation control loop. Connect a ceramic capacitor or a resistor combined with a capacitor from COMP to GND.
16	12	PWM	<b>Input signal for PWM brightness control.</b> By applying a PWM signal on this pin, the LED current is chopped, and the average current is equal to I <sub>SET</sub> × D <sub>DIM</sub> , where I <sub>SET</sub> is the LED current value set by a resistor between the ISET pin and GND, and D <sub>DIM</sub> is the PWM input signal's duty cycle. Ensure that the high-level voltage exceeds 1.2V and the low-level voltage is below 0.4V. If the PWM pin is floating, weakly pull it to GND internally.
	/	EP	<b>Exposed pad.</b> Connect the exposed pad to GND.

**ABSOLUTE MAXIMUM RATINGS** <sup>(1)</sup>

V <sub>IN</sub> .....	-0.3V to +37V
V <sub>CC</sub> , V <sub>GATE</sub> .....	-0.3V to +16V
V <sub>LED1</sub> to V <sub>LED4</sub> .....	-0.3V to +80V
All other pins .....	-0.3V to +6.5V
Continuous power dissipation (T <sub>A</sub> = 25°C) <sup>(2)</sup>	
TSSOP-16EP.....	2.78W
SOIC-16.....	1.56W
Junction temperature .....	150°C
Lead temperature .....	260°C
Storage temperature.....	-60°C to +150°C

**ESD Ratings**

Human body model (HBM) .....	±2kV
Charged device model (CDM) .....	±750V

**Recommended Operating Conditions** <sup>(3)</sup>

Supply voltage (V <sub>IN</sub> ) .....	6V to 33V
Max LED current.....	400mA <sup>(5)</sup>
Operating junction temp.....	-40°C to +125°C

<b>Thermal Resistance</b> <sup>(4)</sup>	<b>θ<sub>JA</sub></b>	<b>θ<sub>JC</sub></b>
TSSOP-16EP .....	45 .....	10... °C/W
SOIC-16.....	80.....	35.... °C/W

**Notes:**

- 1) Exceeding these ratings may damage the device.
- 2) The maximum allowable power dissipation is a function of the maximum junction temperature, T<sub>J</sub> (MAX), the junction-to-ambient thermal resistance, θ<sub>JA</sub>, and the ambient temperature, T<sub>A</sub>. The maximum allowable continuous power dissipation at any ambient temperature is calculated by P<sub>D</sub> (MAX) = (T<sub>J</sub> (MAX) - T<sub>A</sub>) / θ<sub>JA</sub>. Exceeding the maximum allowable power dissipation can produce an excessive die temperature, which may cause the regulator to go into thermal shutdown. Internal thermal shutdown circuitry protects the device from permanent damage.
- 3) The device is not guaranteed to function outside of its operating conditions.
- 4) Measured on JESD51-7, a 4-layer PCB.
- 5) Not tested in production. Guaranteed by characterization.

## ELECTRICAL CHARACTERISTICS

V<sub>IN</sub> = 15V, V<sub>EN</sub> = 5V, T<sub>A</sub> = 25°C, unless otherwise noted.

Parameters	Symbol	Condition	Min	Typ	Max	Unit
<b>General</b>						
Operating input voltage	V <sub>IN</sub>		6		33	V
Quiescent supply current	I <sub>Q</sub>	V <sub>IN</sub> = 15V, no switching		3	4	mA
Shutdown supply current	I <sub>ST</sub>	V <sub>EN</sub> = 0V, V <sub>IN</sub> = 15V			1	μA
Low-dropout (LDO) output voltage	V <sub>CC</sub>	13V < V <sub>IN</sub> , 0 < I <sub>CC</sub> < 10mA	10.5	12	13.5	V
V <sub>CC</sub> under-voltage lockout (UVLO) threshold	V <sub>CC_UVLO</sub>	Rising edge	4.5	5	5.5	V
V <sub>CC</sub> UVLO hysteresis threshold				500		mV
Enable (EN) high threshold	V <sub>EN_HIGH</sub>	V <sub>EN</sub> rising	1.2			V
EN low threshold	V <sub>EN_LOW</sub>	V <sub>EN</sub> falling			0.4	V
<b>Step-Up Converter</b>						
Gate driver sourcing impedance		V <sub>CC</sub> = 12V, V <sub>GATE</sub> = 12V		4		Ω
Gate driver sinking impedance		V <sub>CC</sub> = 12V, I <sub>GATE</sub> = 10mA		3.4		Ω
Switching frequency	f <sub>SW</sub>	R <sub>OSC</sub> = 100kΩ	450	500	550	kHz
OSC pin voltage	V <sub>OSC</sub>	R <sub>OSC</sub> = 100kΩ, f <sub>SW</sub> = 500kHz	0.75	0.8	0.85	V
Maximum duty cycle	D <sub>MAX</sub>	R <sub>OSC</sub> = 100kΩ, f <sub>SW</sub> = 500kHz	89			%
Cycle-by-cycle ISENSE current limit		Duty = 89%	160	200		mV
Latch-off ISENSE current limit				500		mV
COMP source current limit	I <sub>COMP_SOLI</sub>	1V < COMP < 2.7V		75		μA
COMP sink current limit	I <sub>COMP_SILI</sub>	1V < COMP < 2.7V		15		μA
COMP transconductance	G <sub>COMP</sub>	ΔI <sub>COMP</sub> = ±10μA		400		μA/V
<b>Current Dimming</b>						
PWM input low threshold	V <sub>PWM_LO</sub>	V <sub>PWM</sub> falling			0.4	V
PWM input high threshold	V <sub>PWM_HI</sub>	V <sub>PWM</sub> rising	1.2			V
ADIM input low threshold	V <sub>ADIM_LO</sub>	V <sub>ADIM</sub> falling			0.4	V
ADIM input high threshold	V <sub>ADIM_HI</sub>	V <sub>ADIM</sub> rising	1.2			V
<b>Current Regulation</b>						
ISET pin voltage	V <sub>ISET</sub>		1.17	1.2	1.23	V
LEDx average current	I <sub>LED</sub>	R <sub>ISET</sub> = 13.33kΩ, analog and PWM dimming duty cycle = 100%	87	90	93	mA
		R <sub>ISET</sub> = 12kΩ, PWM dimming duty cycle = 100%, analog dimming duty cycle = 5%	5	6	7	mA
Current matching <sup>(6)</sup>		R <sub>ISET</sub> = 13.33kΩ, analog and PWM dimming duty cycle = 100%, I <sub>LED</sub> = 90mA			1.8	%
		R <sub>ISET</sub> = 12kΩ, PWM dimming duty cycle = 100%, analog dimming duty cycle = 5%, I <sub>LED</sub> = 5mA			5.5	%
LEDx regulation voltage		I <sub>LED</sub> = 100mA		250		mV
		I <sub>LED</sub> = 300mA		450		mV

**ELECTRICAL CHARACTERISTICS (continued)**
**V<sub>IN</sub> = 15V, V<sub>EN</sub> = 5V, T<sub>A</sub> = 25°C, unless otherwise noted.**

Parameters	Symbol	Condition	Min	Typ	Max	Unit
<b>Protections</b>						
Over-voltage protection (OVP) threshold	V <sub>OVP_OV</sub>		1.85	2	2.15	V
OVP UVLO threshold	V <sub>OVP_UVLO</sub>	Step-up converter fails		50		mV
LEDx UVLO threshold	V <sub>LEDx_UVLO</sub>			100		mV
LEDx over-voltage (OV) threshold	V <sub>LEDx_OV</sub>		14	18	22	V
Thermal protection threshold <sup>(7)</sup>	T <sub>ST</sub>	Rising edge		150		°C
Thermal protection hysteresis <sup>(7)</sup>				25		°C

**Note:**

- 6) Matching is defined as the difference between the maximum and minimum current divided by 2 times the average current.  
 7) Not tested in production. Guaranteed by characterization.

## TYPICAL PERFORMANCE CHARACTERISTICS

V<sub>IN</sub> = 15V, V<sub>EN</sub> = 5V, 120mA/string, 4 strings, 14 LEDs in series, T<sub>A</sub> = 25°C, unless otherwise noted.

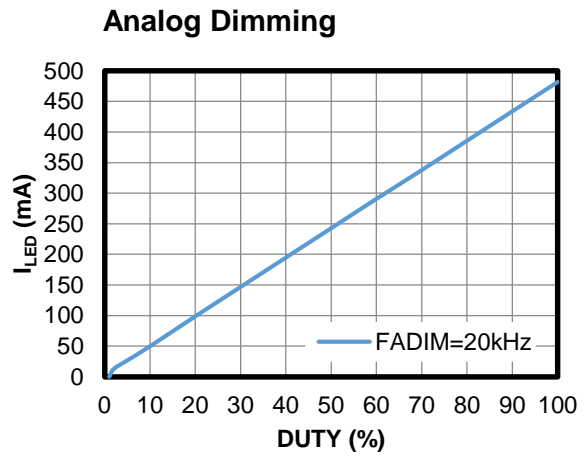
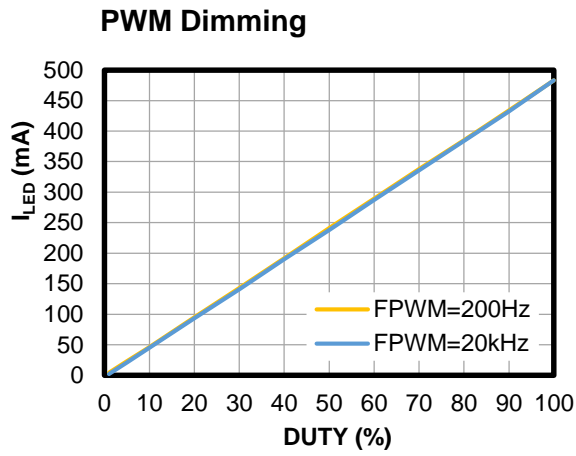



### TYPICAL PERFORMANCE CHARACTERISTICS (continued)

V<sub>IN</sub> = 15V, V<sub>EN</sub> = 5V, 120mA/string, 4 strings, 14 LEDs in series, T<sub>A</sub> = 25°C, unless otherwise noted.

Steady State

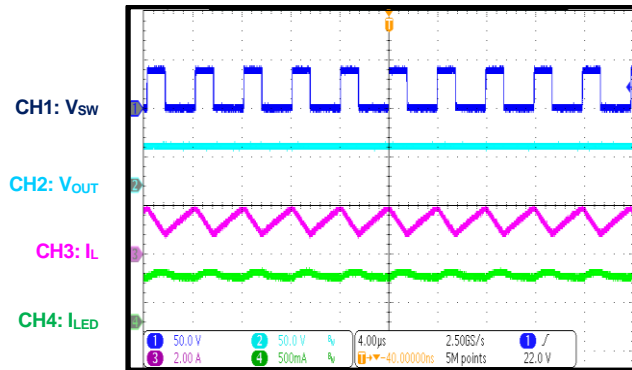

Start-Up through VIN

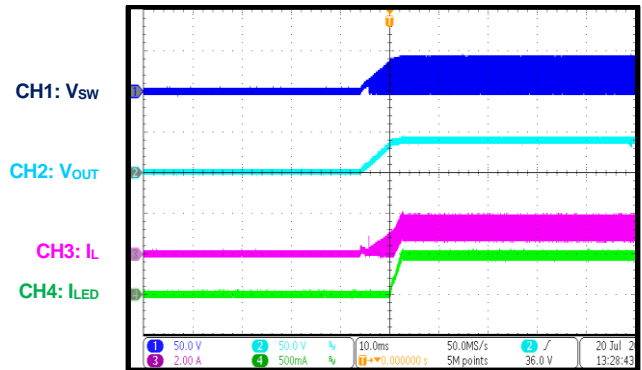

Shutdown through VIN

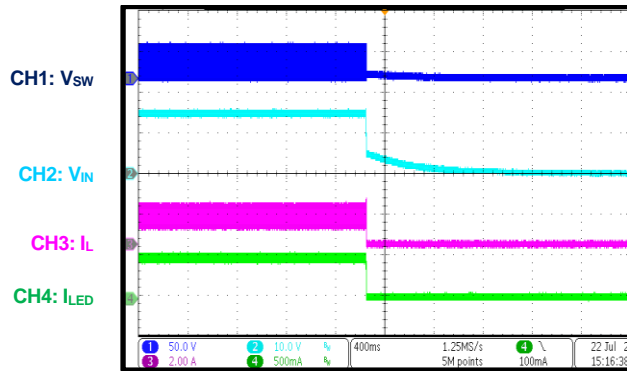

Start-Up through EN

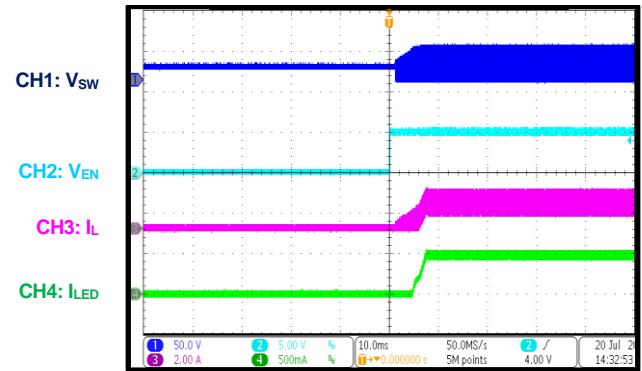

Shutdown through EN

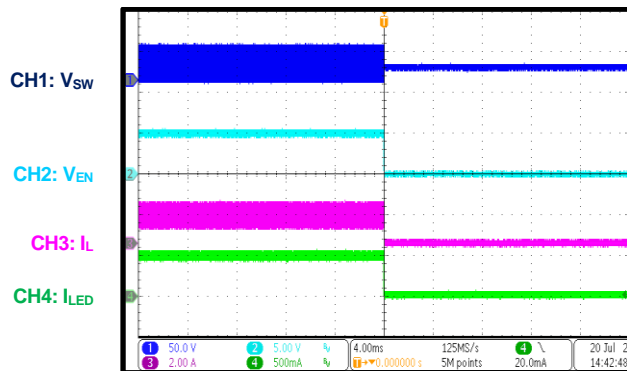

Start-Up through PWM

f<sub>PWM</sub> = 200Hz, D<sub>PWM</sub> = 50%

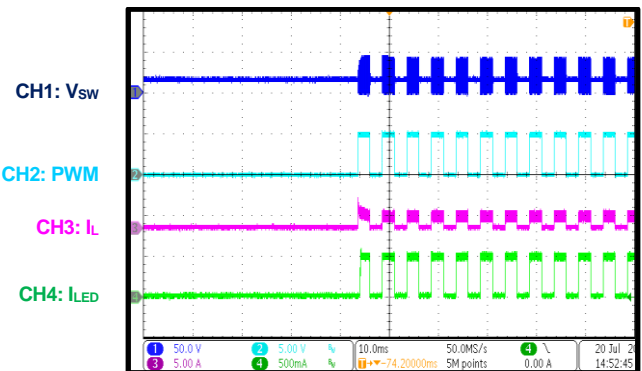

**TYPICAL PERFORMANCE CHARACTERISTICS (continued)**

 V<sub>IN</sub> = 15V, V<sub>EN</sub> = 5V, 120mA/string, 4 strings, 14 LEDs in series, T<sub>A</sub> = 25°C, unless otherwise noted.

**Shutdown through PWM**

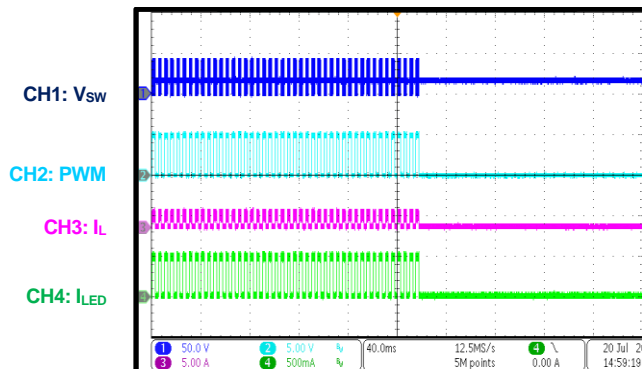
 f<sub>PWM</sub> = 200Hz, D<sub>PWM</sub> = 50%

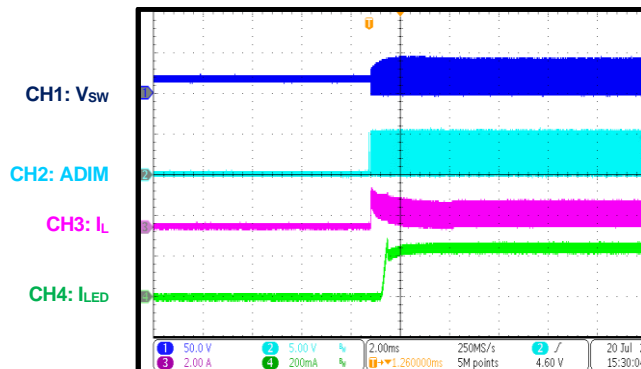
**Start-Up through ADIM**

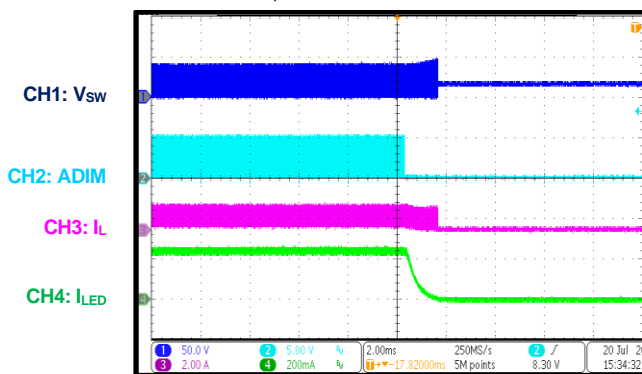
 f<sub>ADIM</sub> = 20kHz, D<sub>ADIM</sub> = 50%

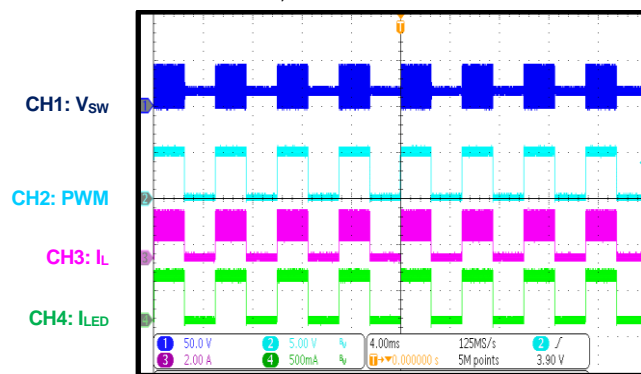
**Shutdown through ADIM**

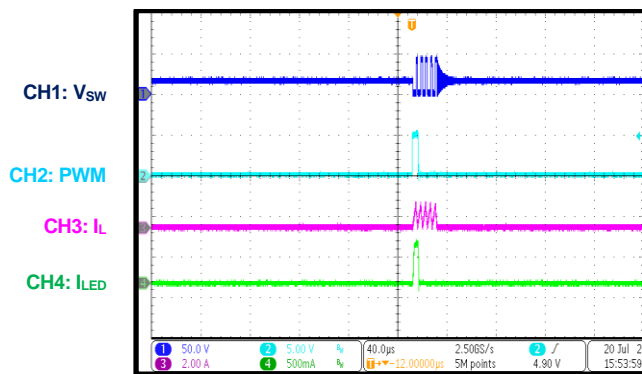
 f<sub>ADIM</sub> = 20kHz, D<sub>ADIM</sub> = 50%

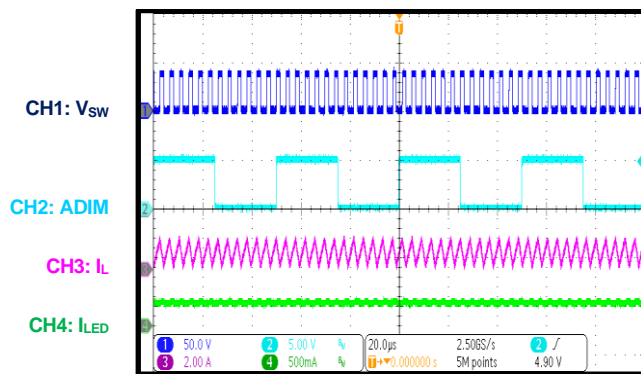
**PWM Dimming**

 f<sub>PWM</sub> = 200Hz, D<sub>PWM</sub> = 50%

**PWM Dimming**

 f<sub>PWM</sub> = 200Hz, D<sub>PWM</sub> = 0.1%

**Analog Dimming**

 f<sub>ADIM</sub> = 20kHz, D<sub>ADIM</sub> = 50%

### TYPICAL PERFORMANCE CHARACTERISTICS (continued)

V<sub>IN</sub> = 15V, V<sub>EN</sub> = 5V, 120mA/string, 4 strings, 14 LEDs in series, T<sub>A</sub> = 25°C, unless otherwise noted.

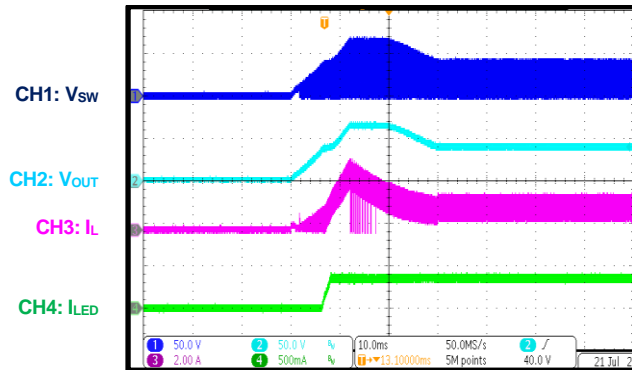
Start-Up with One String Open



Start-Up with All Strings Open

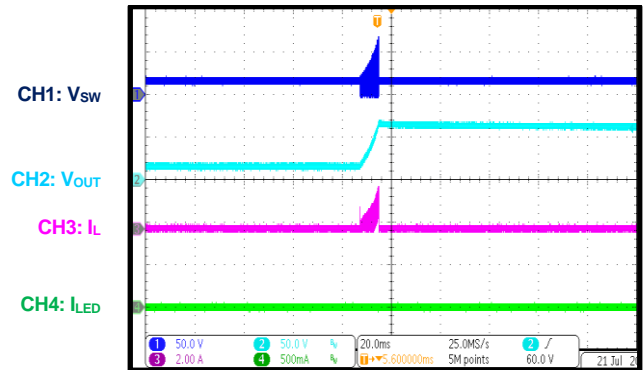

Open One String during Normal Operation

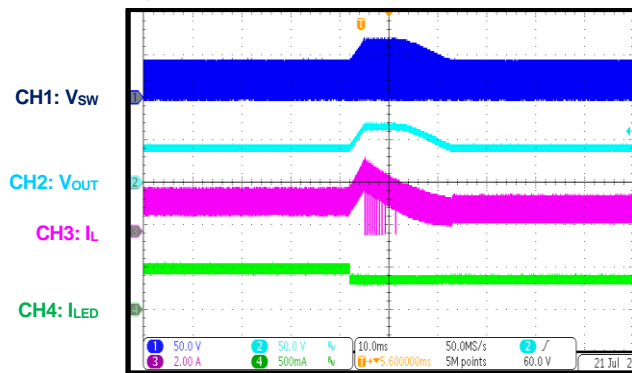

Open All Strings during Normal Operation

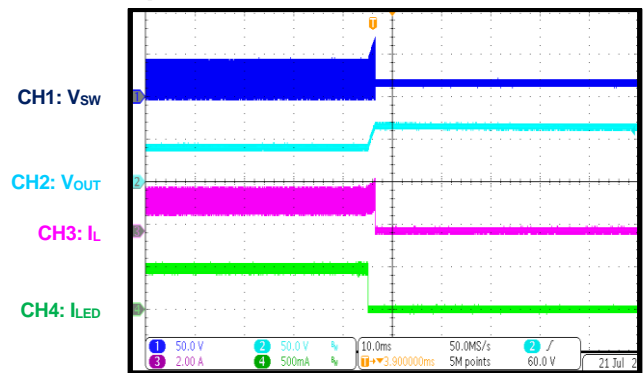

Start-Up with One-String Short

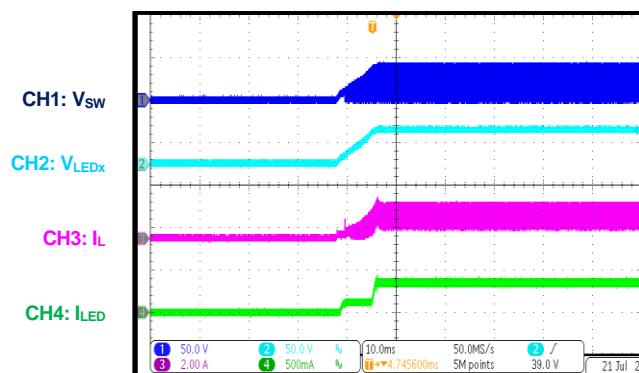

Short One String during Normal Operation

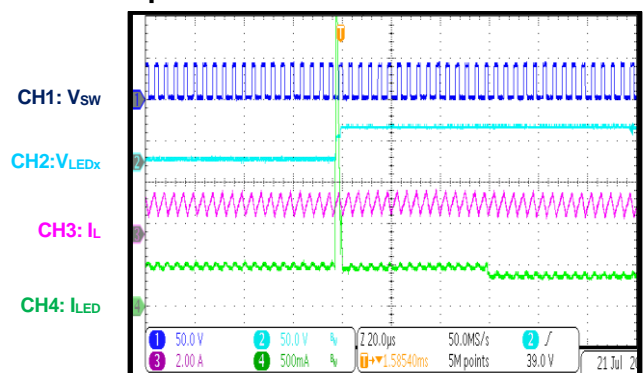

### TYPICAL PERFORMANCE CHARACTERISTICS *(continued)*

V<sub>IN</sub> = 15V, V<sub>EN</sub> = 5V, 120mA/string, 4 strings, 14 LEDs in series, T<sub>A</sub> = 25°C, unless otherwise noted.

**Short Inductor during Normal Operation**

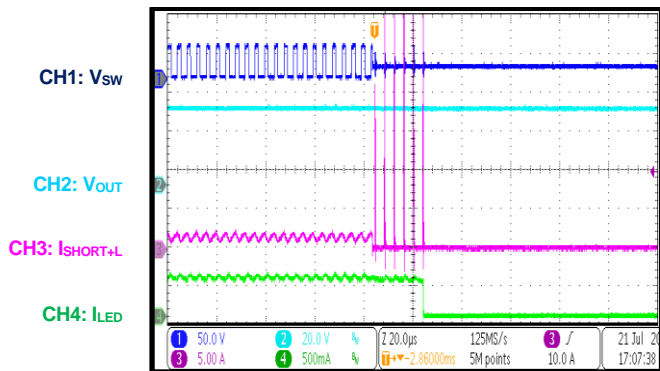

**Short Diode during Normal Operation**

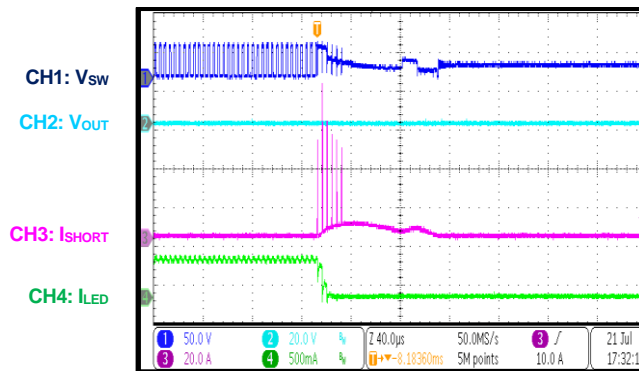

**OTP and Recovery**

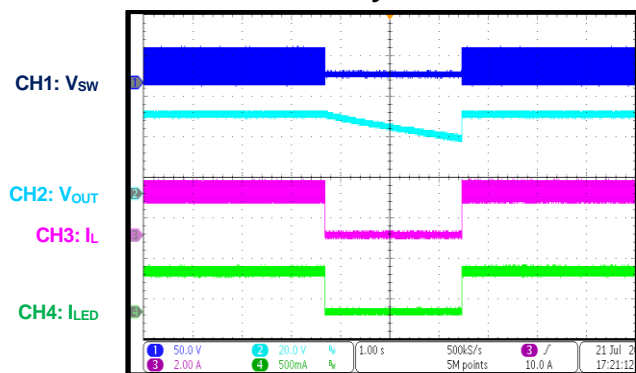

### FUNCTIONAL BLOCK DIAGRAM

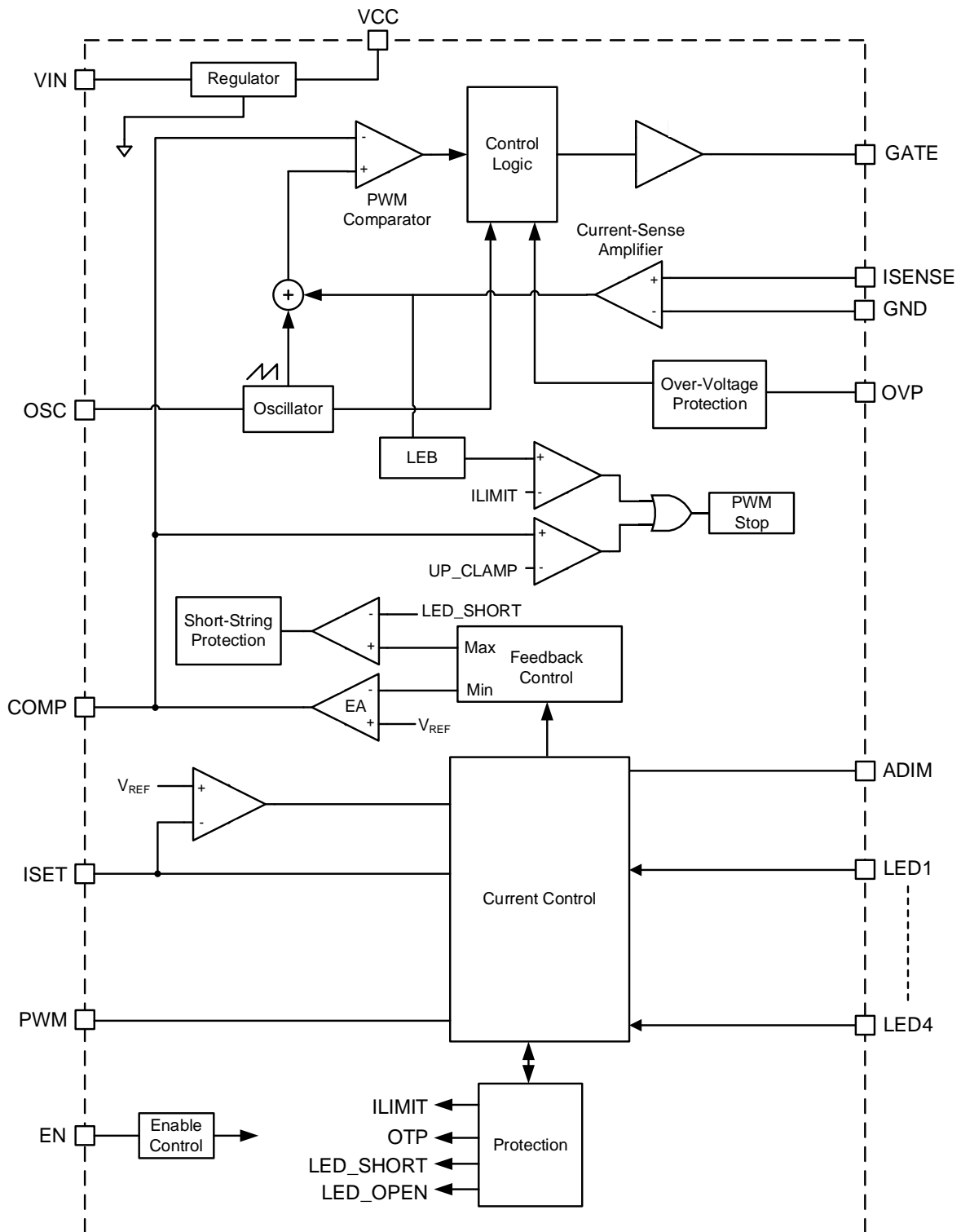

Figure 1: Functional Block Diagram

## OPERATION

The MP3383 is a configurable constant-frequency, peak current control mode, step-up converter with 4-channel regulated current sources to drive an array of up to four white LED strings.

### Internal 12V Regulator

The MP3383 includes an internal linear regulator (VCC). When the input voltage ( $V_{IN}$ ) exceeds 13V, VCC outputs a 12V power supply to the external MOSFET gate driver and the internal control circuitry. The VCC voltage ( $V_{CC}$ ) drops to 0V when the chip shuts down. The MP3383 features under-voltage lockout (UVLO). The chip is disabled until  $V_{CC}$  exceeds the UVLO threshold. The UVLO hysteresis is approximately 500mV.

### System Start-Up

When enabled, the MP3383 checks the topology connection first by monitoring the over-voltage protection (OVP) pin. This determines whether a Schottky diode is connected or the boost output is shorted to GND. An OVP voltage ( $V_{OVP}$ ) exceeding 50mV allows the chip to switch normally. Otherwise, switching is disabled. The MP3383 also checks other safety limits after passing the OVP test, including UVLO, over-temperature protection (OTP), and over-current protection (OCP). If all protection tests pass, the chip then begins boosting the step-up converter with an internal soft start (SS).

To prevent a large inrush current, the enable (EN) signal should occur after the establishment of  $V_{IN}$  and the pulse-width modulation (PWM) dimming signal during the start-up sequence.

### Step-Up Converter

At the beginning of each switching cycle, the internal clock turns on the external MOSFET. During normal operation, the minimum turn-on time of the external MOSFET is around 150ns. Adding a stabilizing ramp to the current-sense amplifier's output prevents subharmonic oscillations for duty cycles greater than 50%, which is then fed into the PWM comparator. When the summed voltage reaches the error amplifier (EA)'s output voltage ( $V_{COMP}$ ), the external MOSFET turns off.

$V_{COMP}$  is an amplified signal of the difference between the reference voltage ( $V_{REF}$ ) and the feedback voltage ( $V_{FB}$ ). The converter automatically chooses the lowest active LEDx pin voltage ( $V_{LEDx}$ ) to provide a sufficient bus voltage to power all LED strings.

If  $V_{FB}$  drops below  $V_{REF}$ , the EA's output voltage ( $V_{COMP}$ ) increases. This results in more current flowing through the MOSFET, increasing the power delivered to the output and forming a closed loop that regulates the output voltage ( $V_{OUT}$ ).

Under light-load operation, especially if  $V_{OUT} \approx V_{IN}$ , the converter runs in pulse-skipping mode. In this mode, the MOSFET turns on for a minimum on time and then the converter discharges the power to the load for the remaining period. The external MOSFET remains off until  $V_{OUT}$  must be boosted again.

### Dimming Control

The MP3383 provides two dimming methods: PWM dimming and analog dimming.

For PWM dimming, apply a PWM signal to the PWM pin. The LED current ( $I_{LED}$ ) is chopped by this PWM signal, and the average  $I_{LED}$  is equal to  $I_{SET} \times D_{DIM}$ , where  $D_{DIM}$  is the PWM dimming signal's duty cycle, and  $I_{SET}$  is the full-scale  $I_{LED}$  set by the ISET resistance ( $R_{ISET}$ ).

For analog dimming, apply a PWM signal to the ADIM pin. An internal RC filter (10M $\Omega$  resistor and 100pF capacitor) is integrated to ADIM. This PWM signal is filtered to the DC voltage by the internal RC filter. The  $I_{LED}$  amplitude is equal to  $I_{SET} \times D_{DIM}$ , where  $D_{DIM}$  is the PWM dimming signal's duty cycle, and  $I_{SET}$  is the full-scale  $I_{LED}$  set by  $R_{ISET}$ . A 20kHz or greater PWM signal is recommended for improved filtering.

### Operating Switching Frequency ( $f_{sw}$ )

The MP3383's switching frequency ( $f_{sw}$ ) is set through an external resistor on the OSC pin. This helps optimize both the size of the external components and system efficiency.

### Open-String Protection

Open-string protection is achieved through detecting  $V_{OVP}$  and LEDx voltage ( $V_{LEDx}$ , where “LEDx” can be LED1, LED2, LED3, and LED4). If one or more strings are open, then the respective LEDx pins are pulled to ground and the IC continues charging  $V_{OUT}$  until it reaches the OVP threshold. If the OVP threshold is triggered, then the chip stops switching and marks off the strings for which  $V_{LEDx}$  is below 100mV. Once marked, the remaining LED strings force  $V_{OUT}$  back to normal regulation. The string with the largest voltage drop determines the output regulation value.

The MP3383 always attempts to light at least one string. If all strings are open, the MP3383 shuts down the step-up converter. The open strings remain in this marked-off state until the chip resets.

### Short-String Protection

The MP3383 monitors  $V_{LEDx}$  to determine whether a short-string fault has occurred. If one or more strings are short, then the respective LEDx pins tolerate high-voltage stress. If  $V_{LEDx}$  exceeds the protection threshold for 16 switching cycles (128 switching cycles, optionally), short-string protection is triggered, and the fault string is marked off and disabled. Once a string is marked off, it disconnects from the  $V_{OUT}$  loop until  $V_{IN}$  or EN restarts.

To prevent mistripping a short LED protection when the LED string is open, the short LED

protection function is disabled when  $V_{LEDx}$  for all used LED channels exceeds 2.1V.

For applications where  $V_{OUT} > 90V$ , use an external MOSFET to carry the huge voltage when the whole LED string is shorted.

### Cycle-by-Cycle Current Limit

To prevent the external components from exceeding their respective current stress ratings, the IC employs cycle-by-cycle current-limit protection. When the current-sense voltage across the sense resistor (connected between ISENSE and GND) reaches the cycle-by-cycle current-limit threshold, the external MOSFET turns off until the next clock cycle begins.

### Short Inductor and Diode Protection

When the external inductor or diode is shorted, the IC provides protection by detecting the current flowing through the power MOSFET. If the current-sense voltage across the sense resistor (connected between ISENSE and GND) exceeds the latch-off current limit threshold and lasts for five switching cycles, the IC stops switching and latches off.

### Thermal Shutdown

The MP3383 monitors the silicon die temperature to prevent the IC from operating at exceedingly high temperatures. If the die temperature exceeds the threshold ( $T_{ST}$ ), the IC shuts down. Once the die temperature drops below the lower threshold, the IC restarts and resumes normal operation. The hysteresis value is typically 25°C.

## APPLICATION INFORMATION

### Selecting the Switching Frequency (f<sub>SW</sub>)

The step-up converter's f<sub>SW</sub> is recommended to be between 100kHz and 900kHz for most applications. A resistor on OSC sets the internal f<sub>SW</sub> for the step-up converter. f<sub>SW</sub> can be estimated using Equation (1):

$$f_{SW} \text{ (kHz)} = \frac{50000}{R_{OSC} \text{ (k}\Omega\text{)}} \quad (1)$$

For R<sub>OSC</sub> is 100kΩ, f<sub>SW</sub> is set to 500kHz.

### Setting the LED Current

The current in each LED string can be set through the current-setting resistor on ISET, which can be calculated using Equation (2):

$$ISET \text{ (mA)} = \frac{1200}{R_{ISET} \text{ (k}\Omega\text{)}} \quad (2)$$

For R<sub>ISET</sub> is 12kΩ, I<sub>LED</sub> is set to 100mA. Do not leave ISET floating.

### Selecting the Input Capacitor

The input capacitor (C<sub>IN</sub>) reduces the surge current drawn from the input supply and the switching noise from the device. C<sub>IN</sub> impedance at f<sub>SW</sub> should be below the input source impedance to prevent the high-frequency switching current from passing through to the input. Ceramic capacitors with X5R or X7R dielectrics are recommended for their low ESR and small temperature coefficients. For most applications, use a 4.7μF ceramic capacitor in parallel with a 220μF electrolytic capacitor.

### Selecting the Inductor and Current-Sensing Resistor

A larger-value inductor results in reduced ripple current and a lower peak inductor current (I<sub>L(PEAK)</sub>), which reduces stress on the N-channel MOSFET. However, a larger-value inductor has a larger physical size, higher series resistance, and lower saturation current. Choose an inductor that does not saturate under the worst-case load conditions. Select the minimum inductance (L) that ensures the boost converter works in continuous conduction mode (CCM) with high efficiency and good EMI performance.

The required inductance (L) can be calculated using Equation (3):

$$L \geq \frac{\eta \times V_{OUT} \times D \times (1-D)^2}{2 \times f_{SW} \times I_{LOAD}} \quad (3)$$

The duty cycle (D) can be calculated using Equation (4):

$$D = 1 - \frac{V_{IN}}{V_{OUT}} \quad (4)$$

Where I<sub>LOAD</sub> is the LED load current, and η is the efficiency.

The switching current is used for peak current control mode. To avoid reaching the current limit, the voltage across the sensing resistor (R<sub>SENSE</sub>) must be below 80% of the current limit voltage (V<sub>SENSE</sub>) in the worst-case scenario. R<sub>SENSE</sub> can be calculated using Equation (5):

$$R_{SENSE} = \frac{0.8 \times V_{SENSE}}{I_{L(PEAK)}} \quad (5)$$

The peak inductor current (I<sub>L(PEAK)</sub>) can be calculated using Equation (6):

$$I_{L(PEAK)} = \frac{V_{OUT} \times I_{LOAD}}{\eta \times V_{IN}} + \frac{V_{IN} \times (V_{OUT} - V_{IN})}{2 \times L \times f_{SW} \times V_{OUT}} \quad (6)$$

### Selecting the Power MOSFET

The MP3383 is capable of driving a wide variety of N-channel power MOSFETs. The critical MOSFET selection parameters include the maximum drain-to-source voltage (V<sub>DS(MAX)</sub>), maximum current (I<sub>D(MAX)</sub>), on resistance (R<sub>DS(ON)</sub>), gate source charge (Q<sub>GS</sub>), gate drain charge (Q<sub>GD</sub>), and total gate charge (Q<sub>G</sub>).

Ideally, the off-state voltage across the MOSFET is equal to V<sub>OUT</sub>. Considering the voltage spike when the MOSFET turns off, V<sub>DS(MAX)</sub> should be 1.5 times greater than V<sub>OUT</sub>.

The maximum current flowing through the power MOSFET occurs at the minimum V<sub>IN</sub> and maximum output power (P<sub>OUT</sub>). The maximum RMS current through the MOSFET (I<sub>RMS(MAX)</sub>) can be calculated using Equation (7):

$$I_{RMS(MAX)} = I_{IN(MAX)} \times \sqrt{D_{MAX}} \quad (7)$$



The maximum duty cycle (D<sub>MAX</sub>) can be calculated using Equation (8):

$$D_{MAX} \approx \frac{V_{OUT} - V_{IN(MIN)}}{V_{OUT}} \quad (8)$$

The MOSFET's current rating should be 1.5 times greater than I<sub>RMS(MAX)</sub>.

The MOSFET's R<sub>DS(ON)</sub> determines the conduction loss (P<sub>COND</sub>), which can be calculated using Equation (9):

$$P_{COND} = I_{RMS}^2 \times R_{DS(ON)} \times k \quad (9)$$

Where *k* is the MOSFET's temperature coefficient.

The switching loss is related to Q<sub>GD</sub> and Q<sub>GS</sub>, which determine the commutation time. Q<sub>GS</sub> is the charge between the threshold voltage and the plateau voltage when a driver charges the gate, which can be read in the V<sub>GS</sub> vs. Q<sub>G</sub> chart of the MOSFET datasheet. Q<sub>GD</sub> is the charge during the plateau voltage. These two parameters are required to estimate the turn-on and turn-off losses (P<sub>SW</sub>), which can be calculated using Equation (10):

$$P_{SW} = \frac{Q_{GS} \times R_G}{V_{DR} - V_{TH}} \times V_{DS} \times I_{IN} \times f_{SW} + \frac{Q_{GD} \times R_G}{V_{DR} - V_{PLT}} \times V_{DS} \times I_{IN} \times f_{SW} \quad (10)$$

Where V<sub>DR</sub> is the drive voltage, V<sub>TH</sub> is the threshold voltage, V<sub>PLT</sub> is the plateau voltage, V<sub>DS</sub> is the drain-to-source voltage, and R<sub>G</sub> is the gate resistance.

R<sub>G</sub> is recommended to be between 10Ω and 20Ω.

Note that calculating the switching loss is the most difficult part of loss estimation. Equation (10) provides a simplified equation. For more accurate estimates, the calculations become significantly more complex.

The total gate charge (Q<sub>G</sub>) is used to calculate the gate drive loss (P<sub>DR</sub>). P<sub>DR</sub> can be calculated using Equation (11):

$$P_{DR} = Q_G \times V_{DR} \times f_{SW} \quad (11)$$

### Selecting the Output Capacitor

The output capacitor (C<sub>OUT</sub>) keeps the V<sub>OUT</sub> ripple small and ensures feedback loop stability. C<sub>OUT</sub> impedance must be low at f<sub>sw</sub>. Ceramic capacitors with X7R dielectrics are recommended for their low ESR characteristics. A 4.7μF ceramic capacitor in parallel with a 22μF to 47μF electrolytic capacitor is sufficient for most applications.

### Setting the Over-Voltage Protection (OVP)

Open-string protection is achieved by detecting V<sub>OVP</sub>. In some cases, an LED string open fault results in V<sub>FB</sub> always being 0V. The MP3383 continues boosting V<sub>OUT</sub> higher and higher. If V<sub>OUT</sub> reaches the configured OVP threshold, OVP is triggered.

To ensure that the chip functions properly, an appropriate V<sub>OVP</sub> is required. The recommended V<sub>OVP</sub> is about 1.1 to 1.2 times greater than V<sub>OUT</sub> for normal operation. V<sub>OVP</sub> is set by an external resistor on OVP, and can be calculated using Equation (12):

$$V_{OVP} = 2(V) \times \left(1 + \frac{R_{HIGH}}{R_{LOW}}\right) \quad (12)$$

Where R<sub>HIGH</sub> and R<sub>LOW</sub> are the voltage divider resistors between V<sub>OUT</sub> and GND.

### Expanding LED Channels

The MP3383 can expand the number of LED channels by using two or three ICs in parallel. To connect two ICs for a total of eight LED strings, connect the VCC pins of the master IC and the slave IC together to power the slave IC's internal logic circuitry. Connect the COMP pins of the slave IC and the master IC together to regulate the voltage of all eight LED strings. The slave IC's MOSFET driving signal is not used. The boost converter can be driven by the master IC only. Do not leave the slave IC's ISENSE pin floating; connect it to ground. Apply the EN and DIM signals to both ICs.

### PCB Layout Guidelines

Efficient PCB layout is critical for stable operation and reducing EMI noise. For the best results, follow the guidelines below and refer to Figure 2:

1. Ensure that the loop between the external MOSFET, output diode, and ceramic C<sub>OUT</sub> is as small and short as possible since it carries a high-frequency pulse current.
2. Separate the power ground (PGND) and signal ground (GND) to reduce noise affection.
3. Connect PGND and GND together. All logic signals refer to the signal ground.
4. Place ceramic capacitors as close to VIN and VCC as possible.

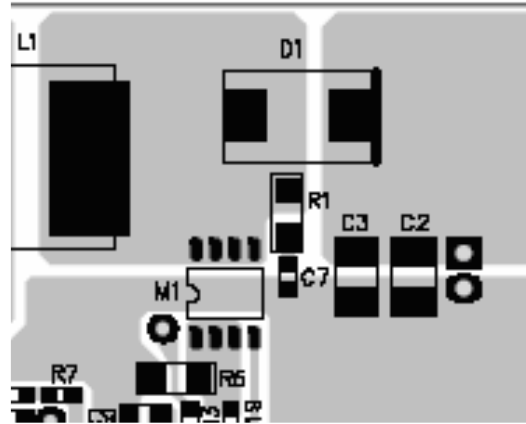
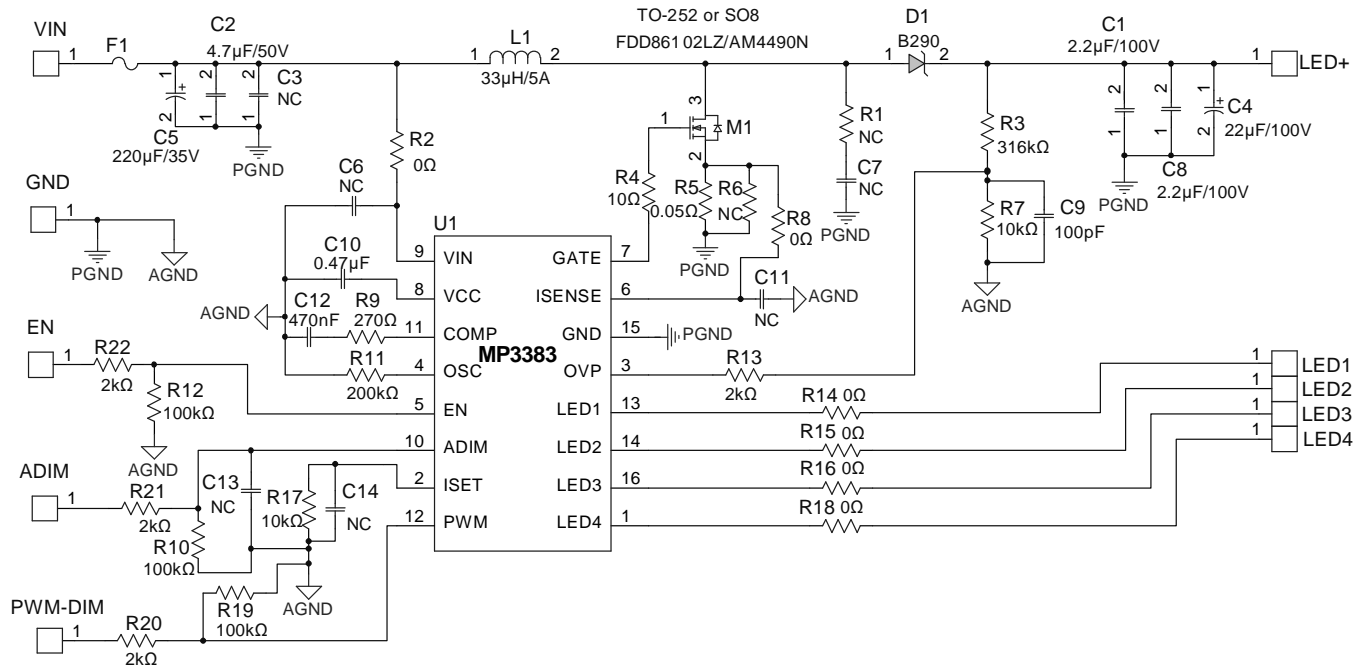

Figure 2: Recommended PCB Layout

**TYPICAL APPLICATION CIRCUIT**

**Figure 3: Typical Application Circuit <sup>(8)</sup>**
**Note:**

8) Some components are adjustable based on real cases.

PACKAGE INFORMATION

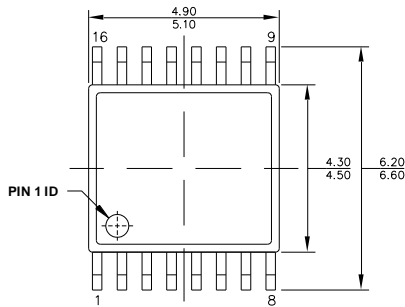
TSSOP-16EP



**TOP VIEW**

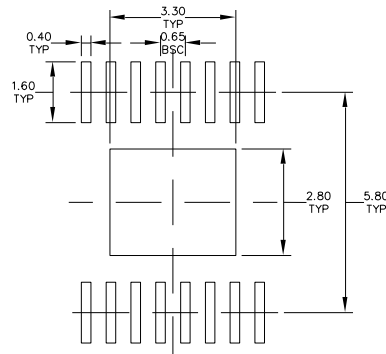

**RECOMMENDED LAND PATTERN**

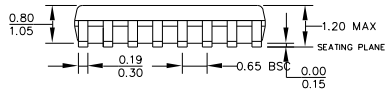

**FRONT VIEW**

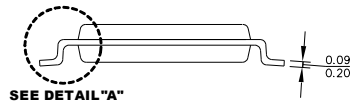

**SEE DETAIL "A"**

**SIDE VIEW**

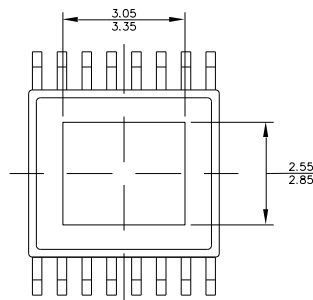

**BOTTOM VIEW**

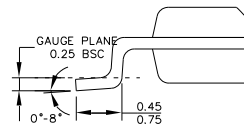

**DETAIL "A"**

**NOTE:**

- 1) ALL DIMENSIONS ARE IN MILLIMETERS
- 2) PACKAGE LENGTH DOES NOT INCLUDE MOLD FLASH, PROTRUSION OR GATE BURR.
- 3) PACKAGE WIDTH DOES NOT INCLUDE INTERLEAD FLASH OR PROTRUSION.
- 4) LEAD COPLANARITY (BOTTOM OF LEADS AFTER FORMING) SHALL BE 0.10 MILLIMETERS MAX.
- 5) DRAWING CONFORMS TO JEDEC MO-153, VARIATION ABT.
- 6) DRAWING IS NOT TO SCALE

## PACKAGE INFORMATION (continued)

## SOIC-16

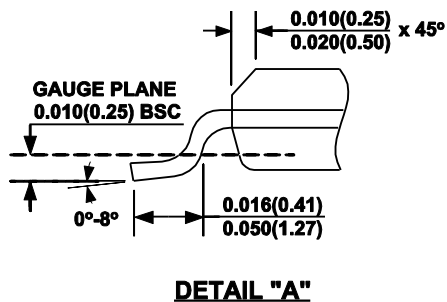
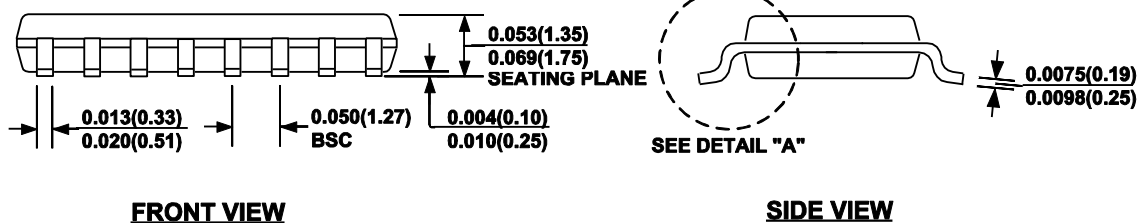
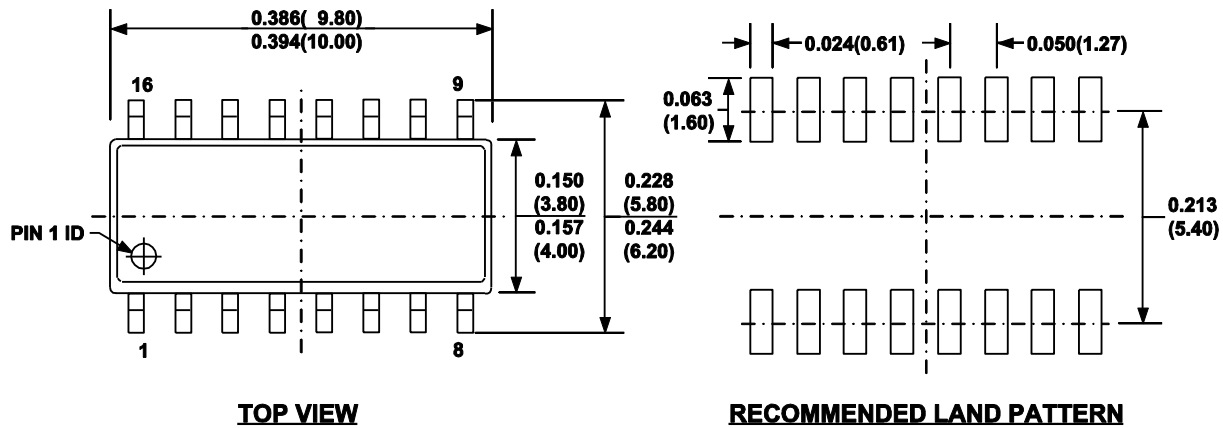
**NOTE:**

- 1) CONTROL DIMENSION IS IN INCHES. DIMENSION IN BRACKET IS IN MILLIMETERS.
- 2) PACKAGE LENGTH DOES NOT INCLUDE MOLD FLASH, PROTRUSIONS OR GATE BURRS.
- 3) PACKAGE WIDTH DOES NOT INCLUDE INTERLEAD FLASH OR PROTRUSIONS.
- 4) LEAD COPLANARITY (BOTTOM OF LEADS AFTER FORMING) SHALL BE 0.004" INCHES MAX.
- 5) DRAWING CONFORMS TO JEDEC MS-012, VARIATION AC.
- 6) DRAWING IS NOT TO SCALE.

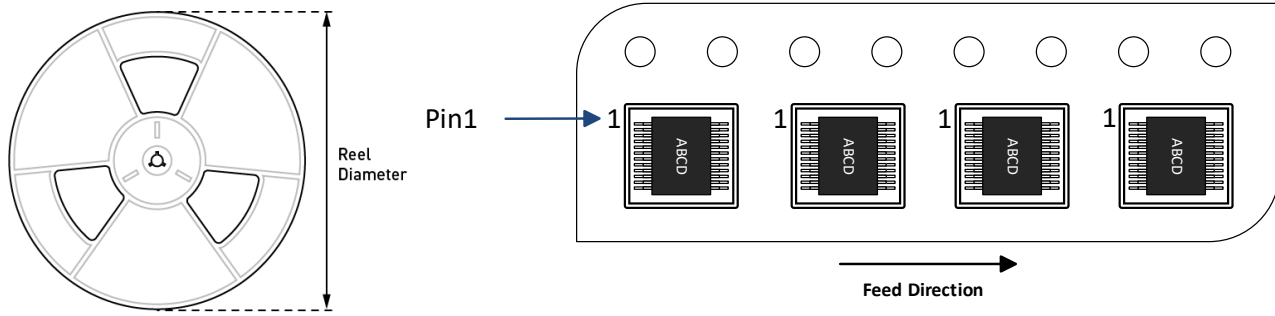
**CARRIER INFORMATION**

Part Number	Package Description	Quantity/ Reel	Quantity/ Tube	Reel Diameter	Carrier Tape Width	Carrier Tape Pitch
MP3383GS-Z	SOIC-16	2500	50	13in	16mm	8mm
MP3383GF-Z	TSSOP-16EP	2500	96	13in	16mm	8mm

## REVISION HISTORY

Revision #	Revision Date	Description	Pages Updated
1.0	5/2/2022	Initial Release	-

**Notice:** The information in this document is subject to change without notice. Please contact MPS for current specifications. Users should warrant and guarantee that third-party Intellectual Property rights are not infringed upon when integrating MPS products into any application. MPS will not assume any legal responsibility for any said applications.