

DESCRIPTION

The MP2110 is a monolithic step-down switch mode converter with integrated input current limit switch. The step-down converter integrates a main switch and a synchronous rectifier for high efficiency without an external Schottky diode. The input average current limit can be externally programmed. It is ideal for powering portable equipment that is powered by an USB port. The MP2110 can supply 3A of load current from a 3.3V to 5.4V continuous input voltage with excellent load and line regulation. The MP2110 input can support up to 12V transient and clamp the current limit switch output at 5.65V (Typical).

The Constant-On-time (COT) control scheme provides fast transient response high light-load efficiency and easy loop stabilization. Fault condition protection includes cycle-by-cycle current limit and thermal shutdown.

The MP2110 is available in a space-saving 14-pin 3mmx3mm QFN package.

FEATURES

- High Efficiency: Up to 95%
- High Current Step-Down Converter
 - ◆ 1.5MHz Switching Frequency
 - ◆ 70mΩ/50mΩ Internal Power MOSFET
 - ◆ 3A Available Load Current
 - ◆ 100% Low Dropout Operation
 - ◆ Output Voltage as Low as 0.6V
- Input Current Limit Switch
 - ◆ Programmable Current Limit: 0.3-3A
 - ◆ ± 10% Current Limit Accuracy when Current Limit > 1A
 - ◆ Wide Input Voltage Range: 3.3V to 5.4V
 - ◆ 12V Input Transient Tolerance
 - ◆ 70mΩ Internal MOSFET
 - ◆ OVP Clamp Protection
- Independent Enable Pins
- External Temperature Sense & Protection
- Internal Thermal Fault Protection
- Space Saving 3mm x 3mm QFN14 Package

APPLICATIONS

- Wireless Modem Data Cards
- USB Powered Devices
- Cellular and Smart Phones
- Portable Instruments

All MPS parts are lead-free and adhere to the RoHS directive. "MPS" and "The Future of Analog IC Technology" are Registered Trademarks of Monolithic Power Systems, Inc. ADAM (Analog Digital Adaptive Modulation), AAM (...) are Trademarks of Monolithic Power Systems, Inc.

TYPICAL APPLICATION

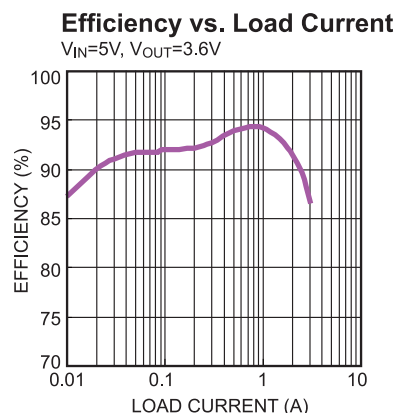
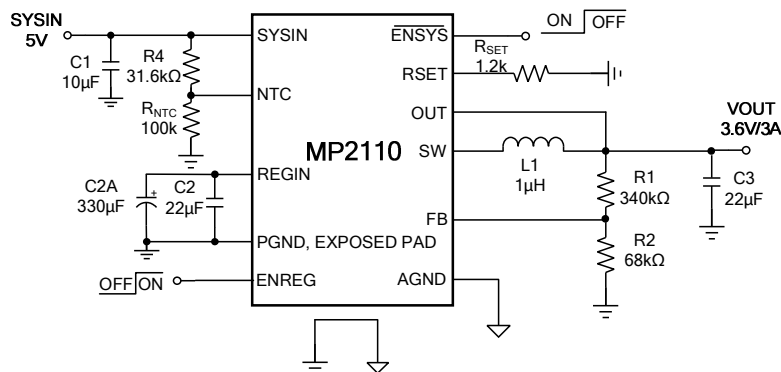

ORDERING INFORMATION

Part Number*	Package	Top Marking
MP2110GQ	QFN-14 (3mm x 3mm)	AFQ

* For Tape & Reel, add suffix -Z (e.g. MP2110GQ-Z).

PACKAGE REFERENCE

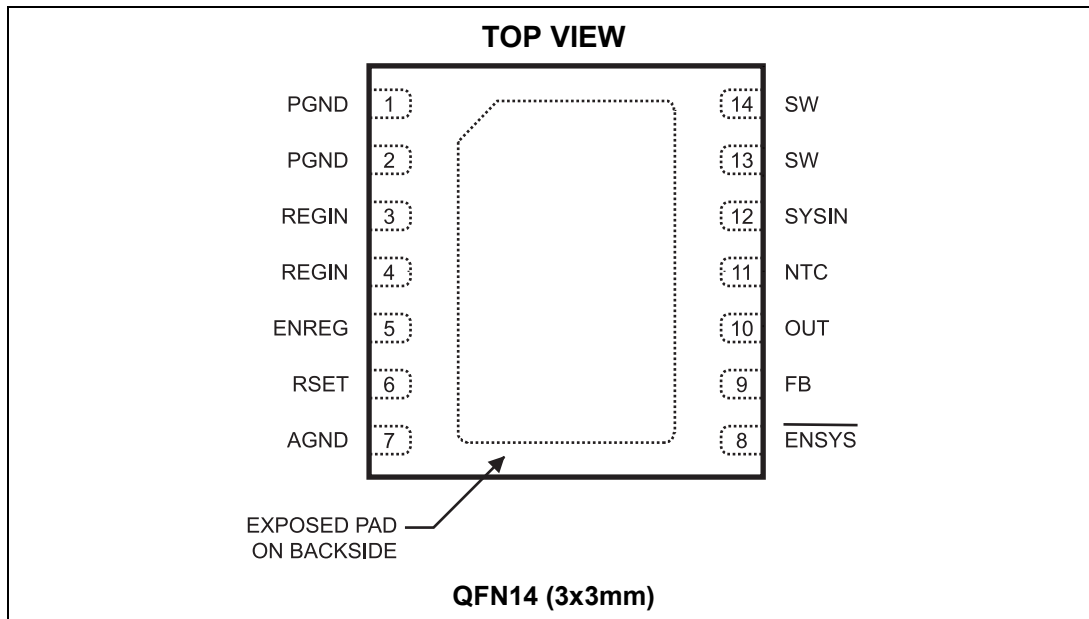

ABSOLUTE MAXIMUM RATINGS ⁽¹⁾

V_{SYSIN}, V_{NTC} to GND	-0.3V to +13V
V_{REGIN} to GND	-0.3V to +6.5V
V_{SW} to GND.....	-0.3V to $V_{REGIN} + 0.3V$
All other pins to GND	-0.3V to +6.5V
Continuous Power Dissipation ($T_A = +25^\circ C$) ⁽²⁾2.5W
Junction Temperature.....	+150°C
Lead Temperature	+260°C
Storage Temperature	-65°C to +150°C

Recommended Operating Conditions ⁽³⁾

Continuous Supply Voltage V_{SYSIN} ..	3.3V to 5.4V
Transient Supply Voltage V_{SYSIN}	12V
Output Voltage V_{OUT}	0.6V to 5V
Operating Junction Temp. (T_J).	-40°C to +125°C

Thermal Resistance ⁽⁴⁾	θ_{JA}	θ_{JC}
QFN-14 (3mmx3mm)	50	12... °C/W

Notes:

- Exceeding these ratings may damage the device.
- The maximum allowable power dissipation is a function of the maximum junction temperature T_J (MAX), the junction-to-ambient thermal resistance θ_{JA} , and the ambient temperature T_A . The maximum allowable continuous power dissipation at any ambient temperature is calculated by P_D (MAX) = $(T_J$ (MAX)- T_A)/ θ_{JA} . Exceeding the maximum allowable power dissipation will cause excessive die temperature, and the regulator will go into thermal shutdown. Internal thermal shutdown circuitry protects the device from permanent damage.
- The device is not guaranteed to function outside of its operating conditions.
- Measured on JESD51-7, 4-layer PCB.

ELECTRICAL CHARACTERISTICS

$V_{SYSIN} = V_{ENREG} = 5.0V$, $V_{ENSYS} = GND$, $L=1\mu H$, $T_A = +25^\circ C$, unless otherwise noted.

Parameter	Symbol	Condition	Min	Typ	Max	Units
Supply Current (No Switching)	I_Q	$V_{FB} = 0.63V$		190	230	μA
Shutdown Current	I_{STD}	$V_{ENSYS} = 5V$		3	5	μA
SYSIN Under Voltage Lockout Threshold	V_{SYSIN_R}	Rising Edge	2.2	2.4	2.6	V
SYSIN Under Voltage Lockout Hysteresis	V_{SYSIN_HYS}			140		mV
REGIN Under Voltage Lockout Threshold	V_{REGIN_R}	Rising Edge	2.5	2.8	3.1	V
REGIN Under Voltage Lockout Hysteresis	V_{REGIN_HYS}			340		mV
Regulator Input Discharge Threshold	V_{DISCH_F}	SYSIN Falling	2.7	2.9	3.1	V
Discharge Hysteresis	V_{DISCH_HYS}			100		mV
Discharge MOSEFT On Resistance	R_{ON_DISCH}	$V_{SYSIN} = 2.6V$		8.5	15	Ω
External Thermal Sense Trip Voltage	V_{NCT_R}	$R_{NTC}=NCP18WF104$ (100°C), $R_4=31.6k\Omega$	12.5	14.5	16.5	$\%V_{SYSIN}$
External Thermal Sense Recovery Voltage	V_{NCT_F}	$R_{NTC}=NCP18WF104$ (80°C), $R_4=31.6k\Omega$	25	27	29	$\%V_{SYSIN}$
System Input Current Limit Switch						
Current Limit Switch On Resistance	R_{ON_SW}	$I_{SWITCH}=100mA$		70	85	m Ω
Current Limit	I_{LIMIT1}	$R_{SET} = 13.3k\Omega$	290	390	490	mA
	I_{LIMIT2}	$R_{SET} = 5.1k\Omega$	710	810	910	mA
	I_{LIMIT3}	$R_{SET} = 3.48k\Omega$	1.05	1.15	1.25	A
EN Input Logic Low Voltage	V_{SYSEN_L}				0.4	V
En Input Logic High Voltage	V_{SYSEN_H}		1.5			V
EN Input Current	I_{SYSEN}	$V_{EN} = 5V$		3.5	7	μA
Output Clamping Voltage	V_{OVP}	Over Protection Voltage	5.45	5.65	5.85	V
Output Soft-start Time	t_{SS}	Output from 10% to 90%		2.5		ms
Step-Down Regulator						
Feedback Voltage	V_{FB}	$2.7V \leq V_{REGIN} \leq 6V$	0.588	0.600	0.612	V
Feedback Current	I_{FB}	$V_{FB}=0.6V$		10	50	nA
PFET Switch On Resistance	R_{DSON_P}	$V_{REGIN} = 5V$		70		m Ω
NFET Switch On Resistance	R_{DSON_N}	$V_{REGIN} = 5V$		50		m Ω

ELECTRICAL CHARACTERISTICS

$V_{SYSIN} = V_{ENREG} = 5.0V$, $V_{ENSY} = GND$, $L=1\mu H$, $T_A = +25^\circ C$, unless otherwise noted.

Parameter	Symbol	Condition	Min	Typ	Max	Units
PFET Current Limit	I_{LIMIT_REG}		3.9	5		A
On Time ⁽⁵⁾	T_{ON}	$V_{OUT}=3.6V$		520		ns
Minimum Off Time ⁽⁵⁾	T_{OFF}			60		ns
Soft-Start Time	t_{SS}	Output from 10% to 90%		1.5		ms
EN Input Logic Low Voltage	V_{ENREG_L}				0.4	V
En Input Logic High Voltage	V_{ENREG_H}		1.5			V
EN Input Current	I_{ENREG}	$V_{EN} = 0V$ to $6V$	-1		1	μA
Thermal Shutdown Trip Threshold ⁽⁵⁾	T_{OTP}			160		$^\circ C$
Thermal Shutdown Hysteresis ⁽⁵⁾	T_{OTP_HYS}			20		$^\circ C$

Note:

5) Guaranteed by characterization test.

PIN FUNCTIONS

Pin #	Name	Description
1, 2	PGND	Power Ground. PGND is internally connected to the source of the low-side N-channel MOSFET.
3, 4	REGIN	Current limit switch output and buck regulator input. Usually this pin connects to a large tantalum capacitor as energy reservoir.
5	ENREG	On/Off Control Input of Step-Down Regulator. Active high. Can not be floated.
6	RSET	Input Current Limit setting pin. A resistor from this pin to ground sets the input current limit.
7	AGND	Analog Ground. Internally connects to the analog ground of control circuitry.
8	ENSYS	Current Limit Switch Enable Input. Active low. It has internal pull down resistor.
9	FB	Feedback Input. Connect FB to the center point of the external resistor divider. The feedback threshold voltage is 0.6V.
10	OUT	Sense pin for output voltage.
11	NTC	Thermistor Input. Connect a resistor from this pin to SYSIN pin and the thermistor from this pin to ground. Connect to SYSIN to disable the thermal sense function.
12	SYSIN	Supply Voltage. SYSIN supplies power for internal current limit switch. MP2110 operates from a 3.3V to 5.4V continuous input voltage and 12V transient input voltage. C1 is needed to prevent large voltage spikes at the input. Put C1 as close to the IC as possible.
13, 14	SW	Power Switch Output. Inductor connection to drains of the internal PFET and NFET switches.
	Exposed Pad	The exposed pad and PGND pin must be connected to the same ground plane.

TYPICAL PERFORMANCE CHARACTERISTICS

$V_{SYSIN}=V_{ENREG}=5.0V$, $V_{ENSY}=GND$, $L=1\mu H$, $T_A=25^\circ C$, unless otherwise noted.

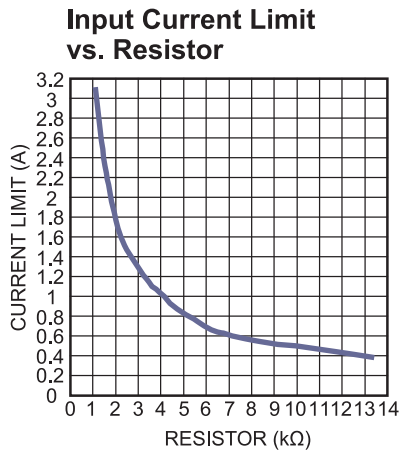
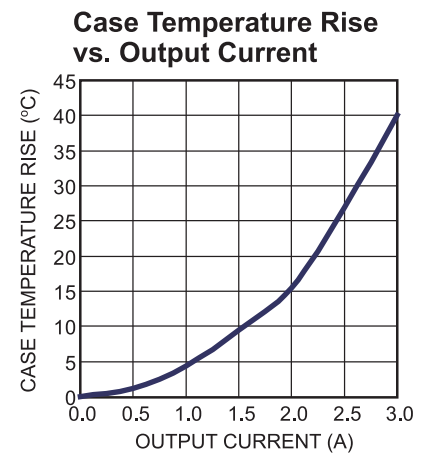
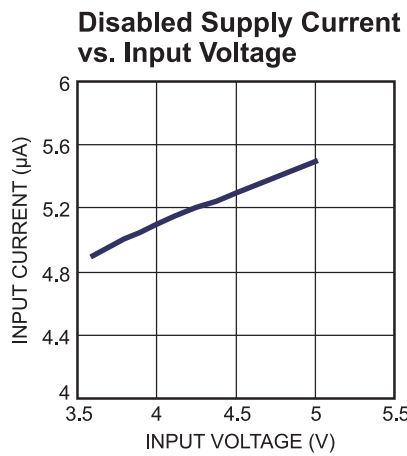
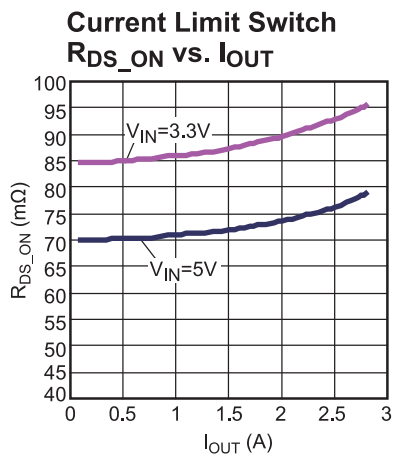
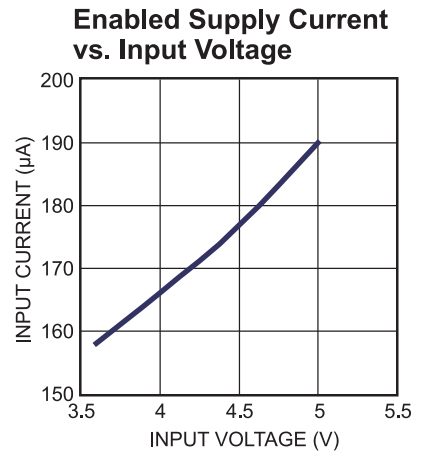
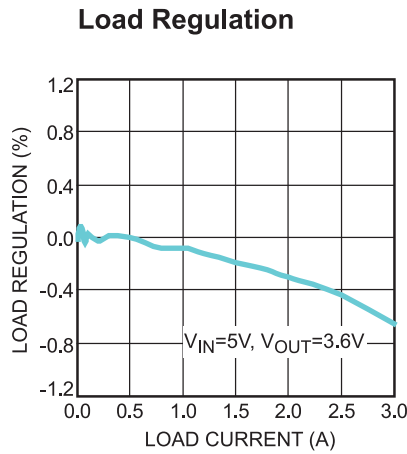
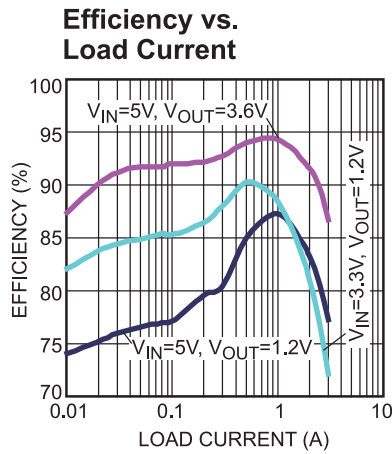

TYPICAL PERFORMANCE CHARACTERISTICS (continued)
 $V_{SYSIN}=V_{ENREG}=5.0V$, $V_{ENSYS}=GND$, $L=1\mu H$, $T_A=25^\circ C$, unless otherwise noted.

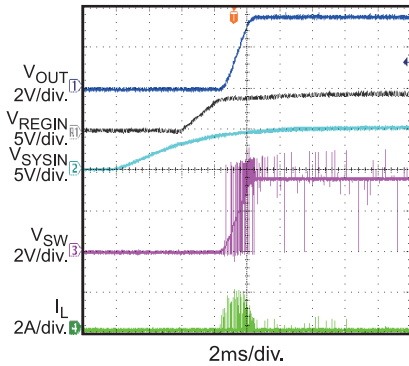
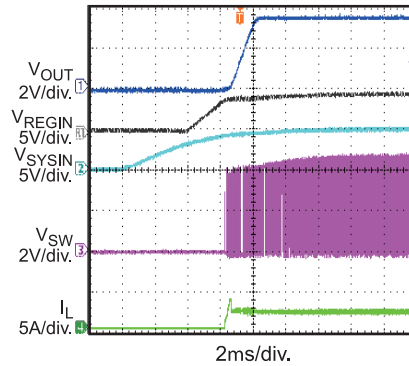
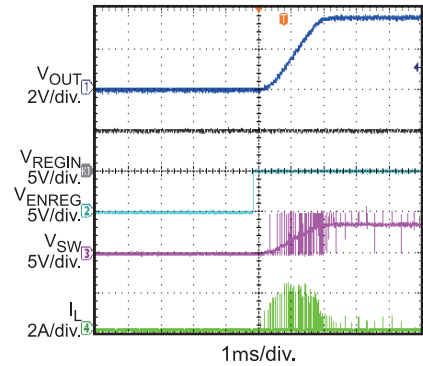
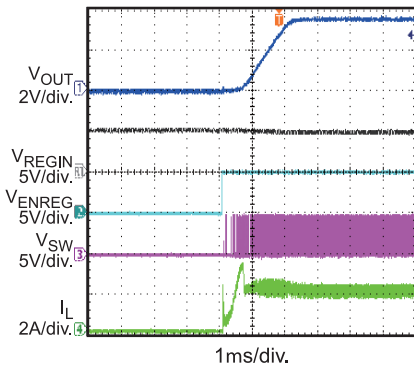
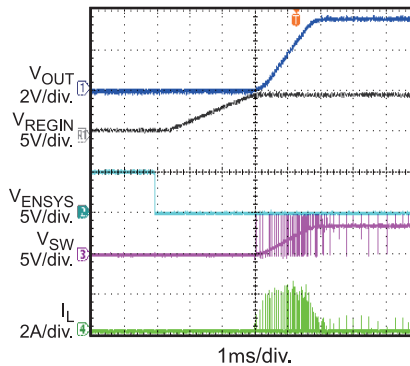
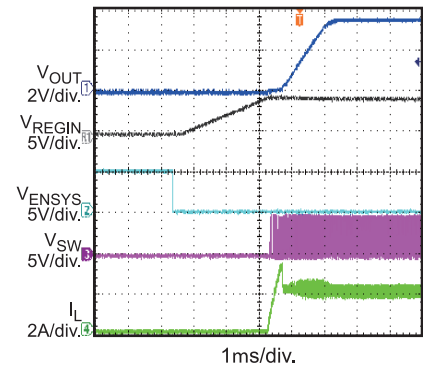
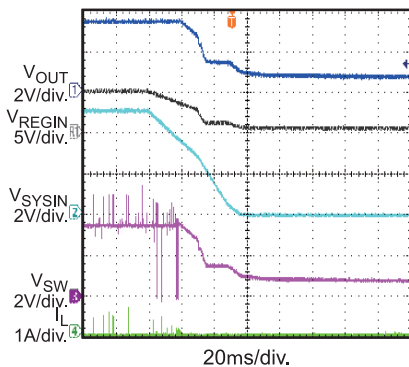
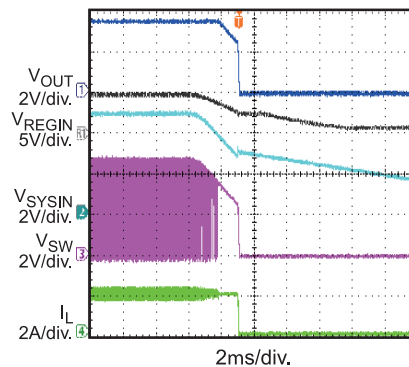
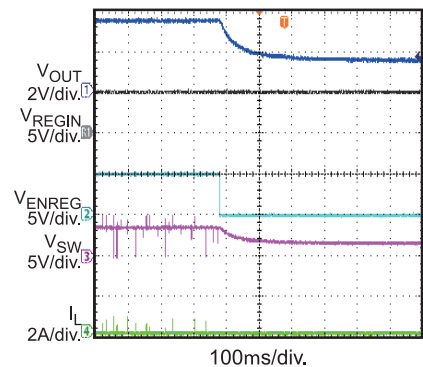
Startup through Input Voltage
 $I_{OUT} = 0A$

Startup through Input Voltage
 $I_{OUT} = 2A$

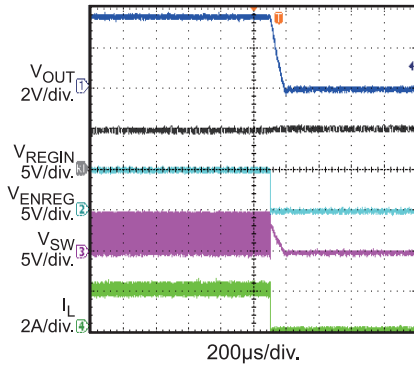
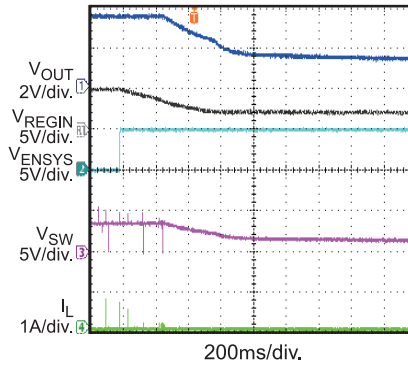
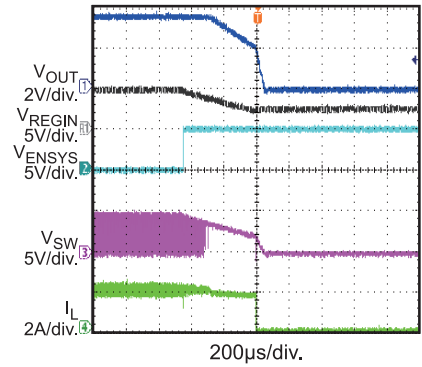
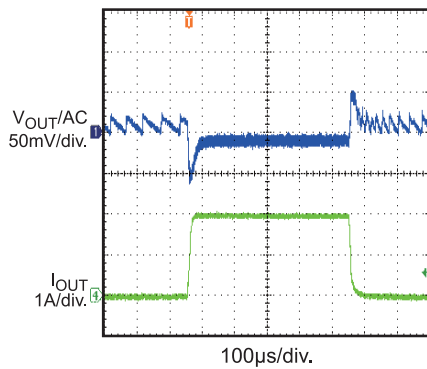
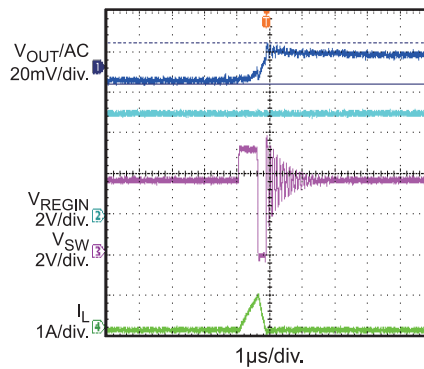
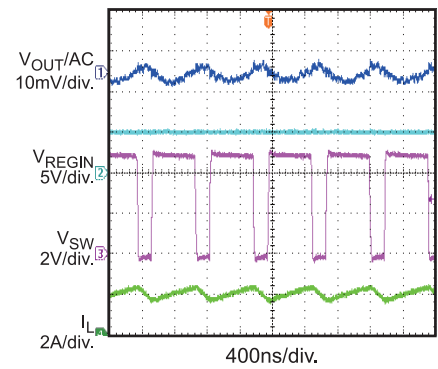
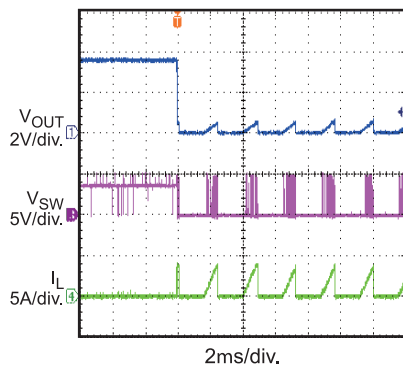
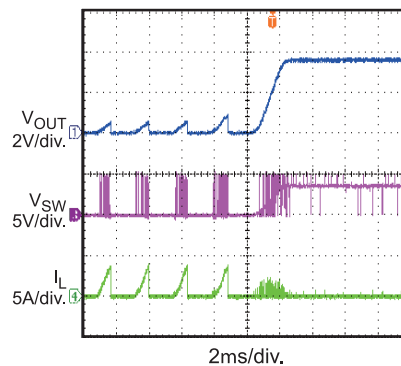
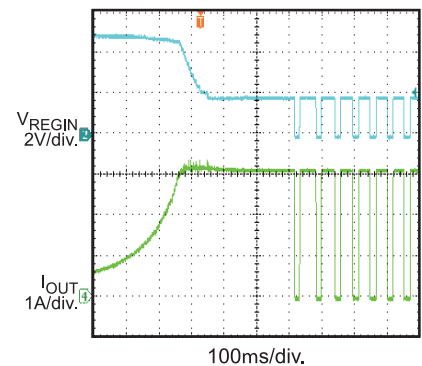
Startup through ENREG
 $I_{OUT} = 0A$

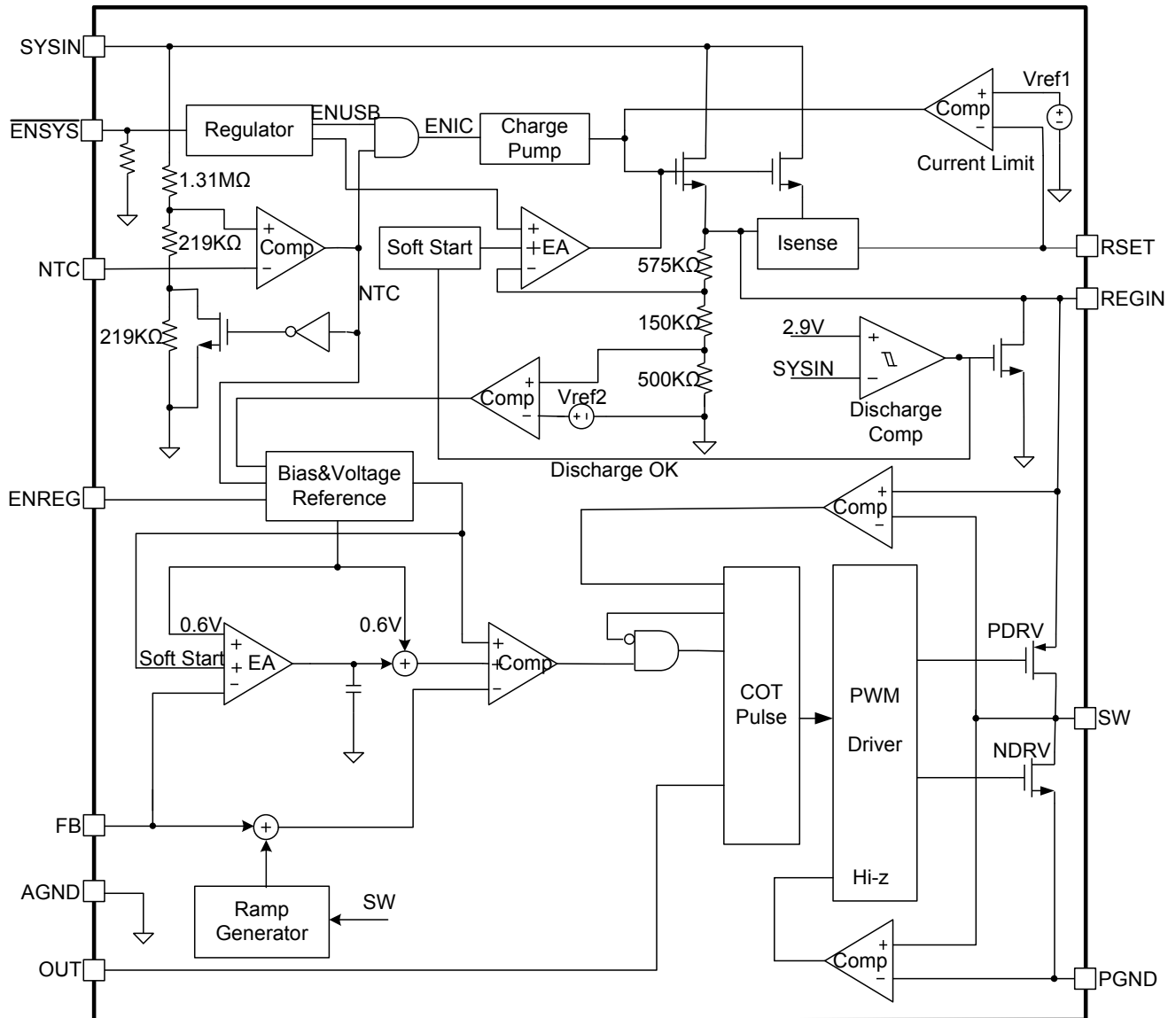
Startup through ENREG
 $I_{OUT} = 2A$

Startup through ENSYS
 $I_{OUT} = 0A$

Startup through ENSYS
 $I_{OUT} = 2A$

Shutdown through Input Voltage
 $I_{OUT} = 0A$

Shutdown through Input Voltage
 $I_{OUT} = 2A$

Shutdown through ENREG
 $I_{OUT} = 0A$

TYPICAL PERFORMANCE CHARACTERISTICS (continued)
 $V_{SYSIN} = V_{ENREG} = 5.0V$, $V_{ENSYS} = GND$, $L = 1\mu H$, $T_A = 25^\circ C$, unless otherwise noted.

Shutdown through ENREG
 $I_{OUT} = 2A$

Shutdown through ENSYS
 $I_{OUT} = 0A$

Shutdown through ENSYS
 $I_{OUT} = 2A$

Transient Response
 $I_{OUT} = 0A-2A$, $2.5A/\mu s$

Output Ripple
 $I_{OUT} = 0A$

Output Ripple
 $I_{OUT} = 2A$

Short Circuit Entry
 $I_{OUT} = 0A$

Short Circuit Recovery
 $I_{OUT} = 0A$

Input Current Limit
 $R_{LIMIT} = 1.2k$

FUNCTIONAL BLOCK DIAGRAM

Figure 1: Functional Block Diagram

OPERATION

The MP2110 is a high efficiency, 1.5MHz, synchronous step-down converter with input current limit switch. The MP2110 is optimized for low voltage, USB port and Li-Ion battery powered applications where high efficiency and small size are critical. The MP2110 can achieve 100% duty cycle.

MP2110 uses constant on-time control with input voltage feed forward to stabilize the switching frequency over full input range. At light load, MP2110 employs a proprietary control of low side switch and inductor current to eliminate ringing on switching node and improve efficiency.

Constant On-time Control

Compare to fixed frequency PWM control, constant on-time control offers the advantage of simpler control loop and faster transient response. By using input voltage feed forward, MP2110 maintains a nearly constant switching frequency across input and output voltage range. The on-time of the switching pulse can be estimated as:

$$T_{ON} = \frac{V_{OUT}}{V_{IN}} \cdot 0.722\mu s$$

To prevent inductor current run away during load transient, MP2110 fixes the minimum off time to be 60ns. However, this minimum off time limit will not affect operation of MP2110 in steady state.

Light Load Operation

In light load condition, MP2110 uses a proprietary control scheme to save power and improve efficiency. Instead of turning off the low side switch immediately when inductor current start to reverse, MP2110 gradually ramp down and regulates the low side switch current to a minimal level, thus avoids the ringing at switching node that always occurs in discontinuous conduction mode (DCM) operation.

Current Limit

MP2110 has a typical 5A current limit for the high side switch. When the high side switch hits current limit, the high side switch will turn off, and low side switch will turn on until the inductor current decreases to the valley current limit. This will prevent inductor current from continuing to build up which will result in damage of the components.

Short Circuit Protection

MP2110 enters short circuit protection mode after the inductor current hits the current limit and lasts for 100μs, and tries to recover from short circuit with hiccup mode. In short circuit protection, MP2110 will disable output power stage, discharge soft-start cap and then automatically try to soft-start again. If the short circuit condition still holds, MP2110 repeats this operation cycle till short circuit disappears and output rises back to regulation level.

Programmable Input Current Limit

The MP2110 has an input current limit protection function. It will insure that the input current doesn't exceed the maximum value, when the input is supplied by the USB. Once the input current triggers the set current limit level, the output current will hold at the current limit until thermal shutdown.

The current limit can be estimated as:

$$I_{LIM} = \frac{0.96 \times 4}{R_{SET} (k\Omega)} (A)^{(6)}$$

The input current limit resistor value can be found from Table 1.

Notes:

6) The formula is theoretic. Refer to table 1 for accurate current limit setting.

Table 1—Resistor vs. Current Limit Setting

I _{LIMIT} (A)	R _{SET} (kΩ)
0.39	13.3
0.6	7.15
0.81	5.1
1.05	3.92
1.15	3.48
1.52	2.4
1.85	1.96
2.05	1.74
2.25	1.58
2.57	1.37
2.83	1.24
3.08	1.13

Output over Voltage Clamp

As the system input voltage rises up and the current limit switch's output exceeds its OVP threshold 5.65V, the output voltage (REGIN) will be clamped to 5.65V.

Current Limit Switch Output Discharge

When the current limit switch's input SYSIN is lower than 2.9V, MP2110 turns on the discharge MOSFET to discharge the REGIN capacitor storage. Discharge resistance is typical 8.5Ω and the specific discharge time depends on the capacitance between REGIN and GND.

Negative Thermal Coefficient (NTC) Thermistor

The MP2110 has a built-in NTC comparator that allows it to sense the external device's temperature via the thermistor mounted near the device. It ensures a safe operating environment

and prevents any smoke and fire happen due to over temperature. Connect an appropriately-valued resistor from SYSIN to the NTC-pin and connect the thermistor from the NTC-pin to AGND. The resistor divider with a dividing ratio depends on device temperature determines the voltage on the NTC-pin. Once the voltage at the NTC-pin falls to 14.5% of V_{SYSIN} , the MP2110 output is disabled. The MP2110 restarts if the voltage rises to 27% of V_{SYSIN} .

Thermal Shutdown

Thermal shutdown is implemented to prevent the chip from operating at exceedingly high temperatures. When the silicon die temperature is higher than 160°C, it shuts down the whole chip. When the temperature is lower than its lower threshold, typically 140°C, the chip is enabled again.

APPLICATION INFORMATION

Output Voltage Setting

The external resistor divider sets the output voltage (see Typical Application Circuit on page 1).

Choose R1 around 200kΩ for optimal transient response. R2 is then given by:

$$R2 = \frac{R1}{\frac{V_{OUT}}{0.6V} - 1}$$

Table 2—Resistor Selection vs. Output Voltage Setting

V _{OUT}	R1	R2
1V	180kΩ (1%)	267kΩ (1%)
1.2V	180kΩ (1%)	180kΩ (1%)
1.8V	180kΩ (1%)	88.7kΩ (1%)
2.5V	340kΩ (1%)	107kΩ (1%)
3.3V	340kΩ (1%)	75kΩ (1%)
3.6V	340kΩ (1%)	68kΩ (1%)

Inductor Selection

A 0.47μH to 4.7μH inductor with DC current rating at least 25% higher than the maximum load current is recommended for most applications. For best efficiency, the inductor DC resistance shall be <200mΩ. See Table 3 for recommended inductors and manufacturers. For most designs, the inductance value can be derived from the following equation:

$$L1 = \frac{V_{OUT} \times (V_{IN} - V_{OUT})}{V_{IN} \times \Delta I_L \times f_{OSC}}$$

Where Δ_{IL} is the Inductor Ripple Current. Choose inductor ripple current approximately 30% of the maximum load current, 3A.

The maximum inductor peak current is:

$$I_{L(MAX)} = I_{LOAD} + \frac{\Delta I_L}{2}$$

Under light load conditions below 100mA, larger inductance is recommended for improved efficiency.

Table 3—Suggested Surface Mount Inductors

Manufacturer	Part Number	Inductance (μH)	Max DCR (Ω)	Saturation Current (A)	Dimensions LxWxH (mm ³)
Würth	744777001	1	0.0084	9	7.3X7.3X4.5
Toko	DFE252012C	1	0.059	3	2.5X2.0X1.2

V_{SYN} Input Capacitor Selection

The input capacitor (C1) reduces the surge current drawn from the input and switching noise from the device. The input capacitor impedance at the switching frequency must be less than input source impedance to prevent high frequency switching current passing to the input. Ceramic capacitors with X5R or X7R dielectrics are highly recommended because of their low ESR and small temperature coefficients. For most applications, a 10μF capacitor is sufficient.

V_{REGIN} Capacitor Selection

The V_{REGIN} capacitor is used to supply the Buck port and with the peak output current, such as during the TDM frame. That output peak current is about 3A. Use a large tantalum capacitor to avoid large voltage drops.

Selecting the Output Capacitor

The output capacitor (C3) is required to maintain the DC output voltage. Ceramic capacitors are recommended. Low ESR capacitors are preferred to keep the output voltage ripple low. The output voltage ripple can be estimated by:

$$\Delta V_{OUT} = \frac{V_{OUT}}{f_s \times L_1} \times \left(1 - \frac{V_{OUT}}{V_{IN}}\right) \times \left(R_{ESR} + \frac{1}{8 \times f_s \times C3}\right)$$

Where L_1 is the inductor value and R_{ESR} is the equivalent series resistance (ESR) value of the output capacitor.

Using ceramic capacitors, the impedance at the switching frequency is dominated by the capacitance. The output voltage ripple is mainly caused by the capacitance. For simplification, the output voltage ripple can be estimated by:

$$\Delta V_{OUT} = \frac{V_{OUT}}{8 \times f_s^2 \times L_1 \times C3} \times \left(1 - \frac{V_{OUT}}{V_{IN}} \right)$$

In the case of tantalum or electrolytic capacitors, the ESR dominates the impedance at the switching frequency. For simplification, the output ripple can be approximated to:

$$\Delta V_{OUT} = \frac{V_{OUT}}{f_s \times L_1} \times \left(1 - \frac{V_{OUT}}{V_{IN}} \right) \times R_{ESR}$$

The characteristics of the output capacitor also affect the stability of the regulation system.

PC Board Layout

PCB layout is very important to achieve stable operation. For best results, follow these guidelines and use Figure 2 as reference:

- 1) Use large ground plane directly connect to PGND pin. Add vias near the PGND pin if bottom layer is ground plane.
- 2) Place the ceramic input capacitor close to SYSIN/REGIN and PGND pins. Keep the connection of input capacitor and SYSIN/REGIN pin as short and wide as possible.
- 3) Route SW away from sensitive analog areas such as FB, OUT pins. It's not recommended to route SW trace under chip's bottom side.

- 4) Place the feedback resistors close to chip to ensure the trace which connects to FB pin as short as possible.

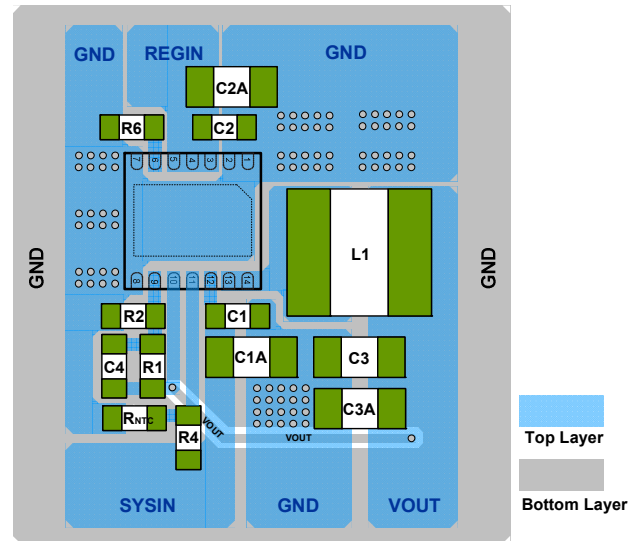

Figure 2: PCB Layout

Design Example

Below is a design example following the application guidelines for the specifications:

Table 4—Design Example

V_{IN}	5V
V_{OUT}	3.6V
I_{OUT}	3A

The detailed application schematic is shown in Figure 3. The typical performance and circuit waveforms have been shown in the Typical Performance Characteristics section. For more device applications, please refer to the related Evaluation Board Datasheet.

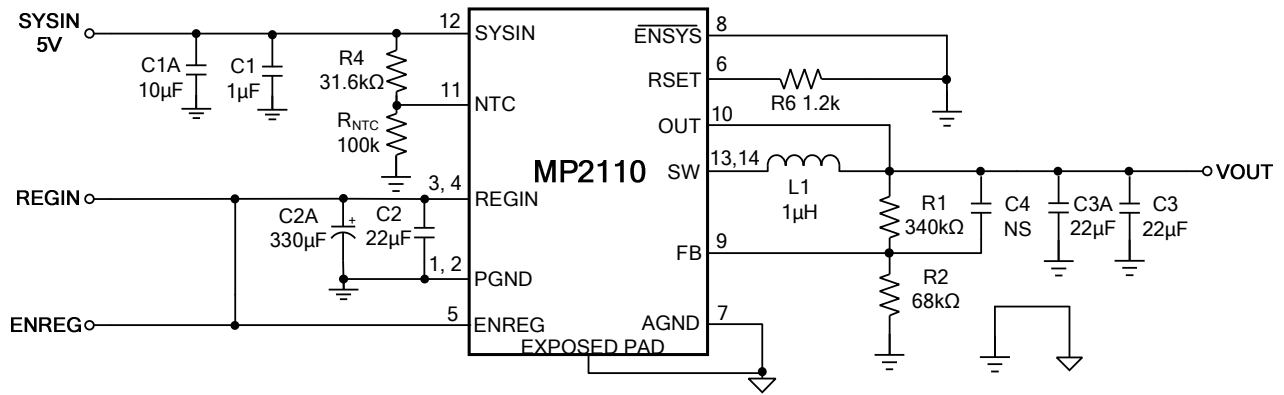
TYPICAL APPLICATION CIRCUITS

Figure 3: Typical Application, 3.6V Output Voltage

PACKAGE INFORMATION

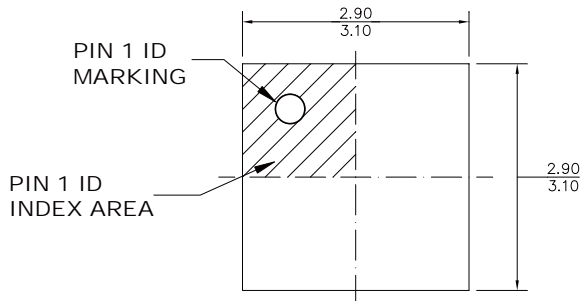
QFN-14 (3mm x 3mm)

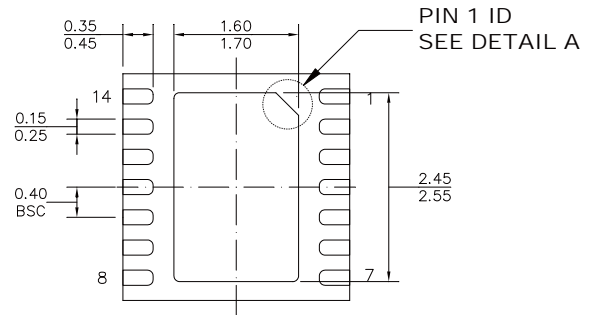

TOP VIEW



BOTTOM VIEW

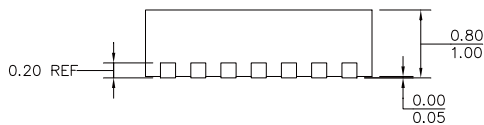

SIDE VIEW

PIN 1 ID OPTION A
0.30x45 TYP.

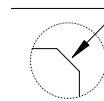

PIN 1 ID OPTION B
R0.20 TYP.

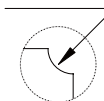

DETAIL A

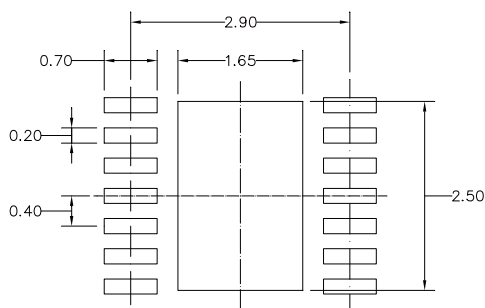

RECOMMENDED LAND PATTERN

NOTE:

- 1) ALL DIMENSIONS ARE IN MILLIMETERS.
- 2) EXPOSED PADDLE SIZE DOES NOT INCLUDE MOLD FLASH.
- 3) LEAD COPLANARITY SHALL BE 0.10 MILLIMETERS MAX.
- 4) JEDEC REFERENCE IS MO-229.
- 5) DRAWING IS NOT TO SCALE.

NOTICE: The information in this document is subject to change without notice. Please contact MPS for current specifications. Users should warrant and guarantee that third party Intellectual Property rights are not infringed upon when integrating MPS products into any application. MPS will not assume any legal responsibility for any said applications.