



The Future of Analog IC Technology®

# MP1601A

## 1A Synchronous Step-down Converter with Forced CCM Mode

### DESCRIPTION

The MP1601A is a monolithic, step-down, switch-mode converter with built-in, internal power MOSFETs. It achieves 1A of continuous output current from a 2.3V to 5.5V input voltage range with excellent load and line regulation. The output voltage can be regulated as low as 0.6V.

The constant-on-time (COT) control scheme in forced continuous conduction mode (CCM) provides a fast transient response, a low output voltage ripple, and eases loop stabilization. Fault protections include cycle-by-cycle current limiting and thermal shutdown.

The MP1601A is available in an ultra-small SOT563 package and requires a minimal number of readily available, standard, external components.

The MP1601A is ideal for a wide range of applications including high-performance DSPs, wireless power, portable and mobile devices, and other low-power systems.

### FEATURES

- 2.2MHz Switching Frequency
- EN for Power Sequencing
- Wide 2.3V to 5.5V Operating Input Range
- Output Adjustable from 0.6V
- Up to 1A Output Current
- 160mΩ and 120mΩ Internal Power MOSFET Switches
- Output Discharge
- 100% Duty Cycle
- Short-Circuit Protection (SCP) with Hiccup Mode
- Stable with Low ESR Output Ceramic Capacitors
- Continuous Conduction Mode (CCM)
- Available in a SOT563 Package

### APPLICATIONS

- Wireless/Networking Cards
- Portable and Mobile Devices
- Battery-Powered/Wearable Devices
- Low-Voltage I/O System Power

All MPS parts are lead-free, halogen-free, and adhere to the RoHS directive. For MPS green status, please visit the MPS website under Quality Assurance. "MPS" and "The Future of Analog IC Technology" are registered trademarks of Monolithic Power Systems, Inc.

### TYPICAL APPLICATION

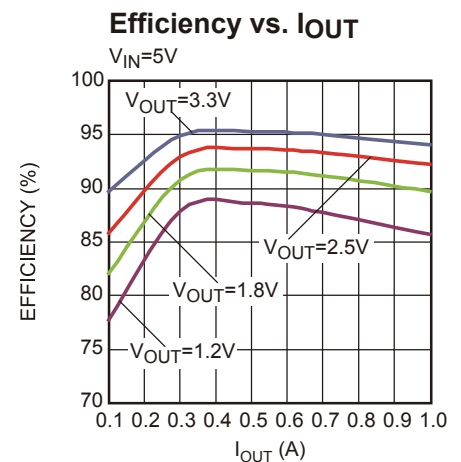
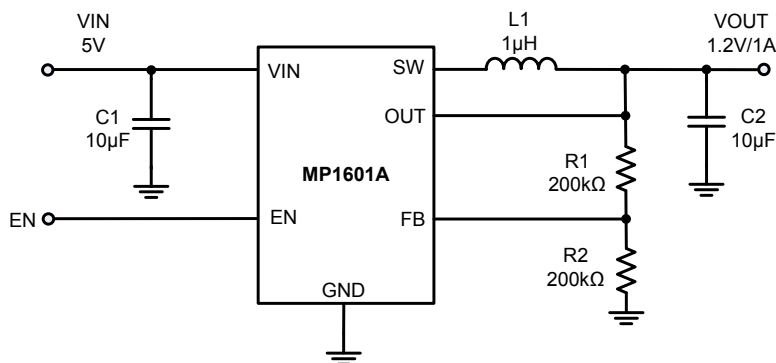

**ORDERING INFORMATION**

Part Number*	Package	Top Marking
MP1601AGTF	SOT563	See Below

\* For Tape & Reel, add suffix -Z (e.g. MP1601AGTF-Z)

**TOP MARKING****AUKY****LLL**

AUK: Product code of MP1601AGTF

Y: Year code

LLL: Lot number

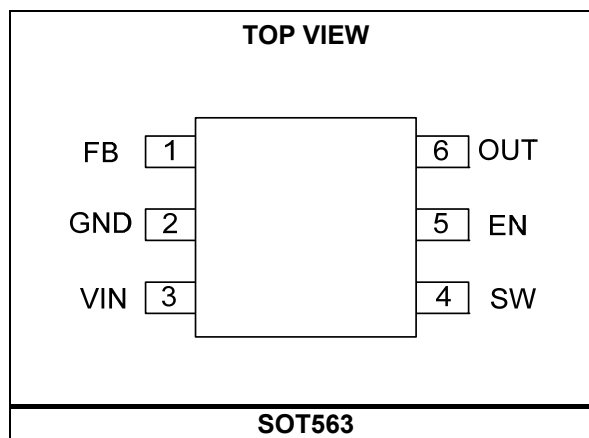
**PACKAGE REFERENCE**

**ABSOLUTE MAXIMUM RATINGS** <sup>(1)</sup>

Supply voltage (VIN).....	6V
V <sub>sw</sub> .....	-0.3V (-5V for <10ns) to 6V (8V for <10ns or 10V for <3ns)
All other pins .....	-0.3V to 6V
Junction temperature .....	150°C
Lead temperature.....	260°C
Continuous power dissipation (T <sub>A</sub> = +25°C) <sup>(2)</sup> .....	1W
Storage temperature .....	-65°C to +150°C

**Recommended Operating Conditions** <sup>(3)</sup>

Supply voltage (VIN).....	2.3V to 5.5V
Operating junction temp. (T <sub>J</sub> )....	-40°C to +125°C

<b>Thermal Resistance</b> <sup>(4)</sup>	<b>θ<sub>JA</sub></b>	<b>θ<sub>JC</sub></b>
SOT563 .....	130 .....	60 ... °C/W

**NOTES:**

- 1) Exceeding these ratings may damage the device.
- 2) The maximum allowable power dissipation is a function of the maximum junction temperature T<sub>J</sub> (MAX), the junction-to-ambient thermal resistance θ<sub>JA</sub>, and the ambient temperature T<sub>A</sub>. The maximum allowable continuous power dissipation at any ambient temperature is calculated by P<sub>D</sub> (MAX) = (T<sub>J</sub> (MAX)-T<sub>A</sub>)/θ<sub>JA</sub>. Exceeding the maximum allowable power dissipation produces an excessive die temperature, causing the regulator to go into thermal shutdown. Internal thermal shutdown circuitry protects the device from permanent damage.
- 3) The device is not guaranteed to function outside of its operating conditions.
- 4) Measured on JESD51-7, 4-layer PCB.

## ELECTRICAL CHARACTERISTICS

V<sub>IN</sub> = 3.6V, T<sub>J</sub> = -40°C to +125°C, typical value is tested at T<sub>J</sub> = +25°C. The limit over temperature is guaranteed by characterization, unless otherwise noted.

Parameter	Symbol	Condition	Min	Typ	Max	Units
Feedback voltage	V <sub>FB</sub>	2.3V ≤ V <sub>IN</sub> ≤ 5.5V, T <sub>J</sub> = 25°C	594	600	606	mV
		T <sub>J</sub> = -40°C to +125°C	588		612	
Feedback current	I <sub>FB</sub>	V <sub>FB</sub> = 0.63V		50	100	nA
P-FET switch on resistance	R <sub>DSON_P</sub>			160		mΩ
N-FET switch on resistance	R <sub>DSON_N</sub>			120		mΩ
Switch leakage current		V <sub>EN</sub> = 0V, T <sub>J</sub> = 25°C		0	1	μA
P-FET peak current limit		Sourcing		2		A
N-FET valley current limit		Sourcing, valley current limit		1.2		A
On time	T <sub>ON</sub>	V <sub>IN</sub> = 5V, V <sub>OUT</sub> = 1.2V		110		ns
		V <sub>IN</sub> = 3.6V, V <sub>OUT</sub> = 1.2V		150		
Switching frequency	f <sub>s</sub>	V <sub>IN</sub> = 5V, V <sub>OUT</sub> = 1.2V, I <sub>OUT</sub> = 500mA, T <sub>J</sub> = 25°C <sup>(5)</sup>		2200		kHz
		V <sub>IN</sub> = 5V, V <sub>OUT</sub> = 1.2V, I <sub>OUT</sub> = 500mA, T <sub>J</sub> = -40°C to +125°C <sup>(5)</sup>		2200		kHz
Minimum off time	T <sub>MIN_OFF</sub>			60		ns
Minimum on time <sup>(5)</sup>	T <sub>MIN_ON</sub>			60		ns
Soft-start time	T <sub>SS_ON</sub>	V <sub>OUT</sub> rise from 10% to 90%		0.5		ms
Under-voltage lockout threshold rising				2	2.25	V
Under-voltage lockout threshold hysteresis				150		mV
EN input logic low voltage					0.4	V
EN input logic high voltage			1.2			V
Output discharge resistor	R <sub>DIS</sub>	V <sub>EN</sub> = 0V, V <sub>OUT</sub> = 1.2V		1		kΩ
EN input current		V <sub>EN</sub> = 2V		1.2		μA
		V <sub>EN</sub> = 0V		0		μA
Supply current (shutdown)		V <sub>EN</sub> = 0V, T <sub>J</sub> = 25°C		0	1	μA
Supply current (quiescent)		V <sub>EN</sub> = 2V, V <sub>FB</sub> = 0.63V, V <sub>IN</sub> = 3.6V, 5V, T <sub>J</sub> = 25°C		0.5		mA
Thermal shutdown <sup>(6)</sup>				160		°C
Thermal hysteresis <sup>(6)</sup>				30		°C

### NOTES:

5) Guaranteed by characterization.

6) Guaranteed by design.

### TYPICAL PERFORMANCE CHARACTERISTICS

$V_{IN} = 5V$ ,  $V_{OUT} = 1.2V$ ,  $L = 1.0\mu H$ ,  $C_{OUT} = 10\mu F$ ,  $T_A = +25^\circ C$ , unless otherwise noted.

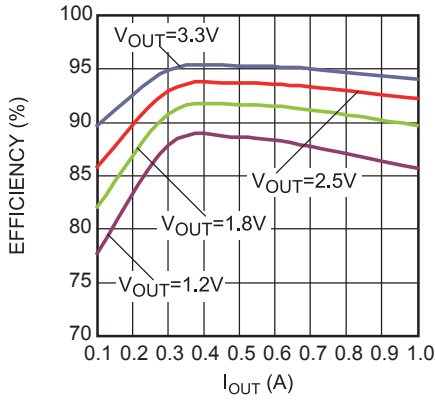
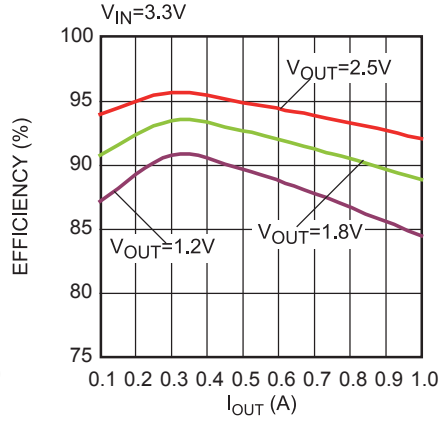
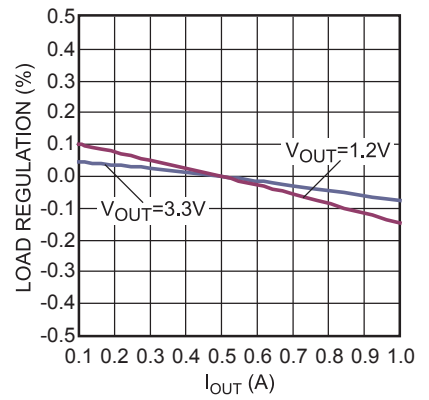
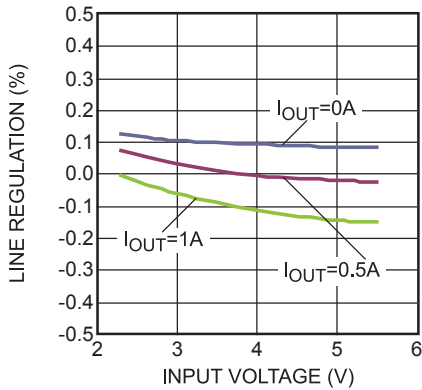
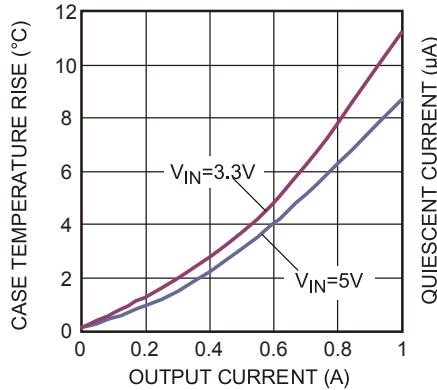
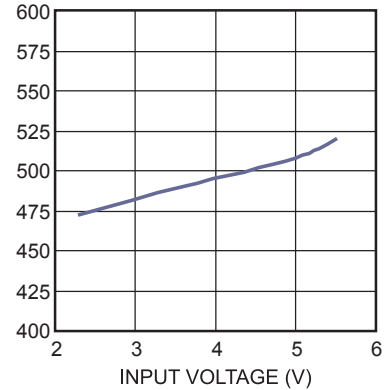
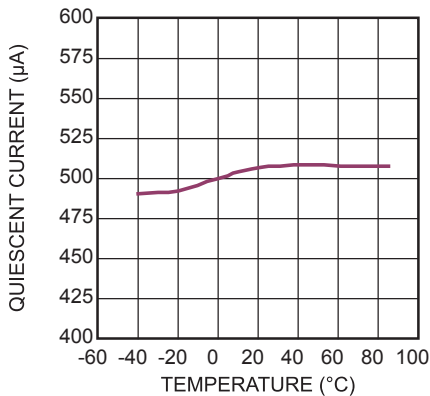
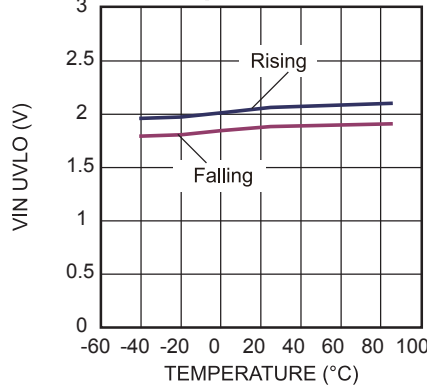
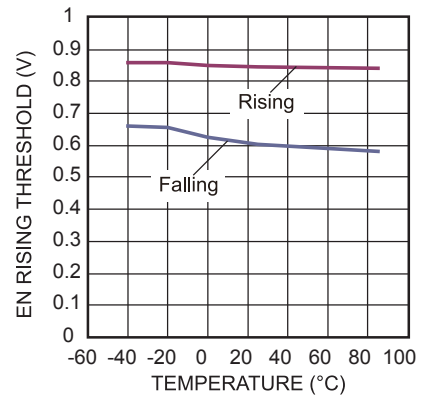
**Efficiency vs.  $I_{OUT}$** 

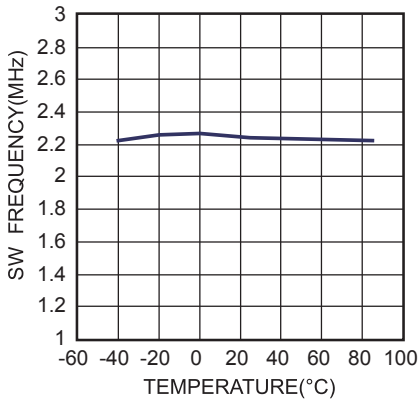
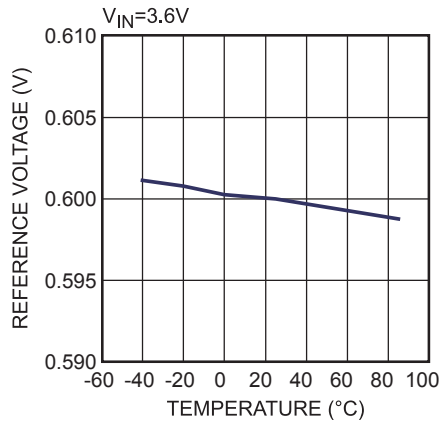
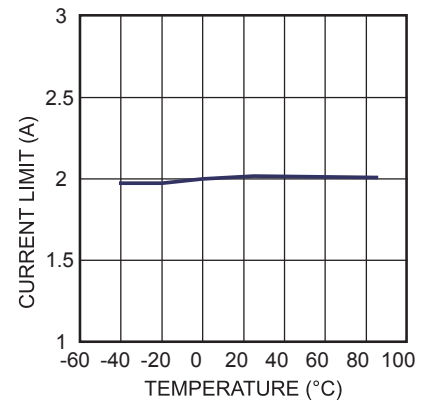
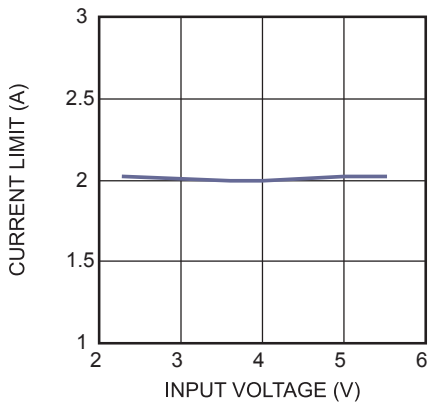
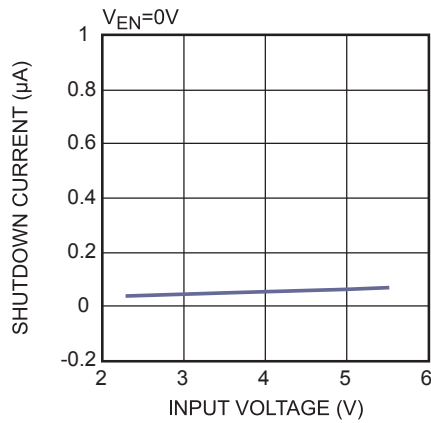
**Efficiency vs.  $I_{OUT}$** 

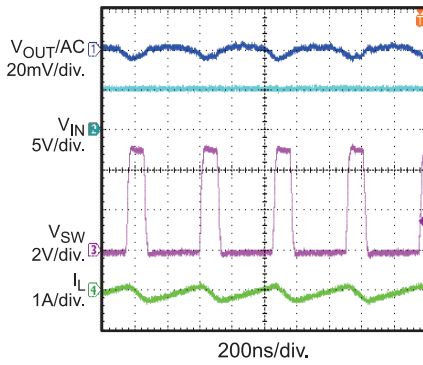
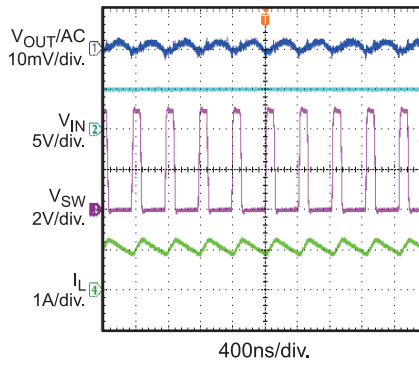
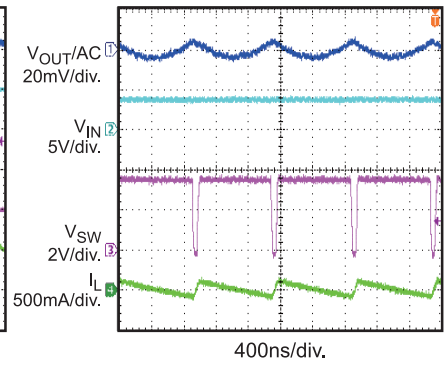
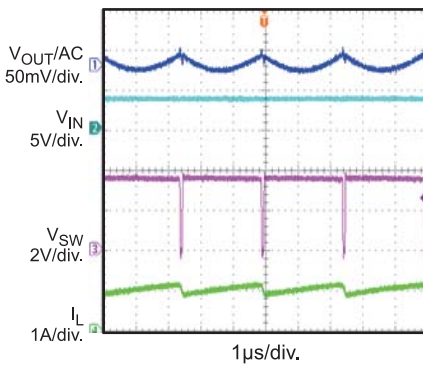
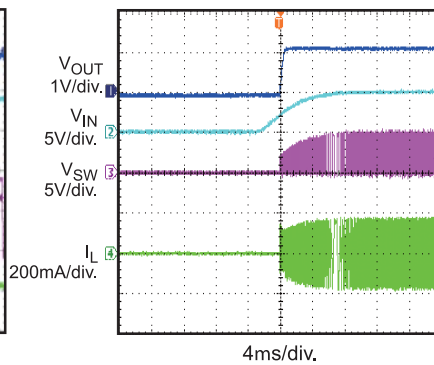
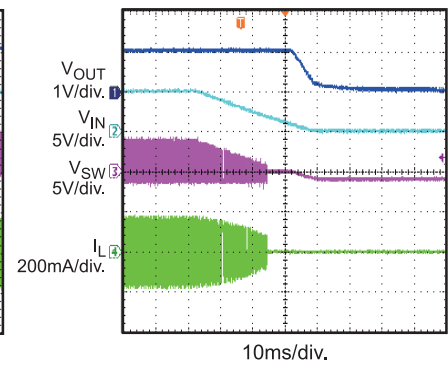
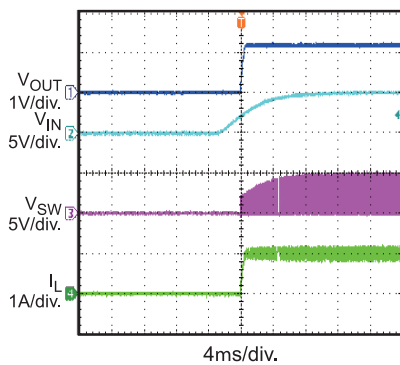
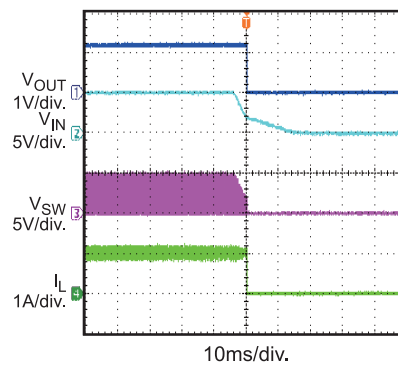
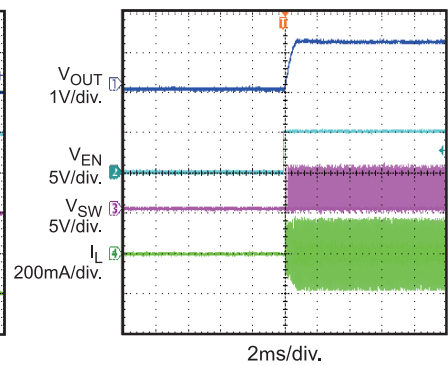
**Load Regulation vs.  $I_{OUT}$** 

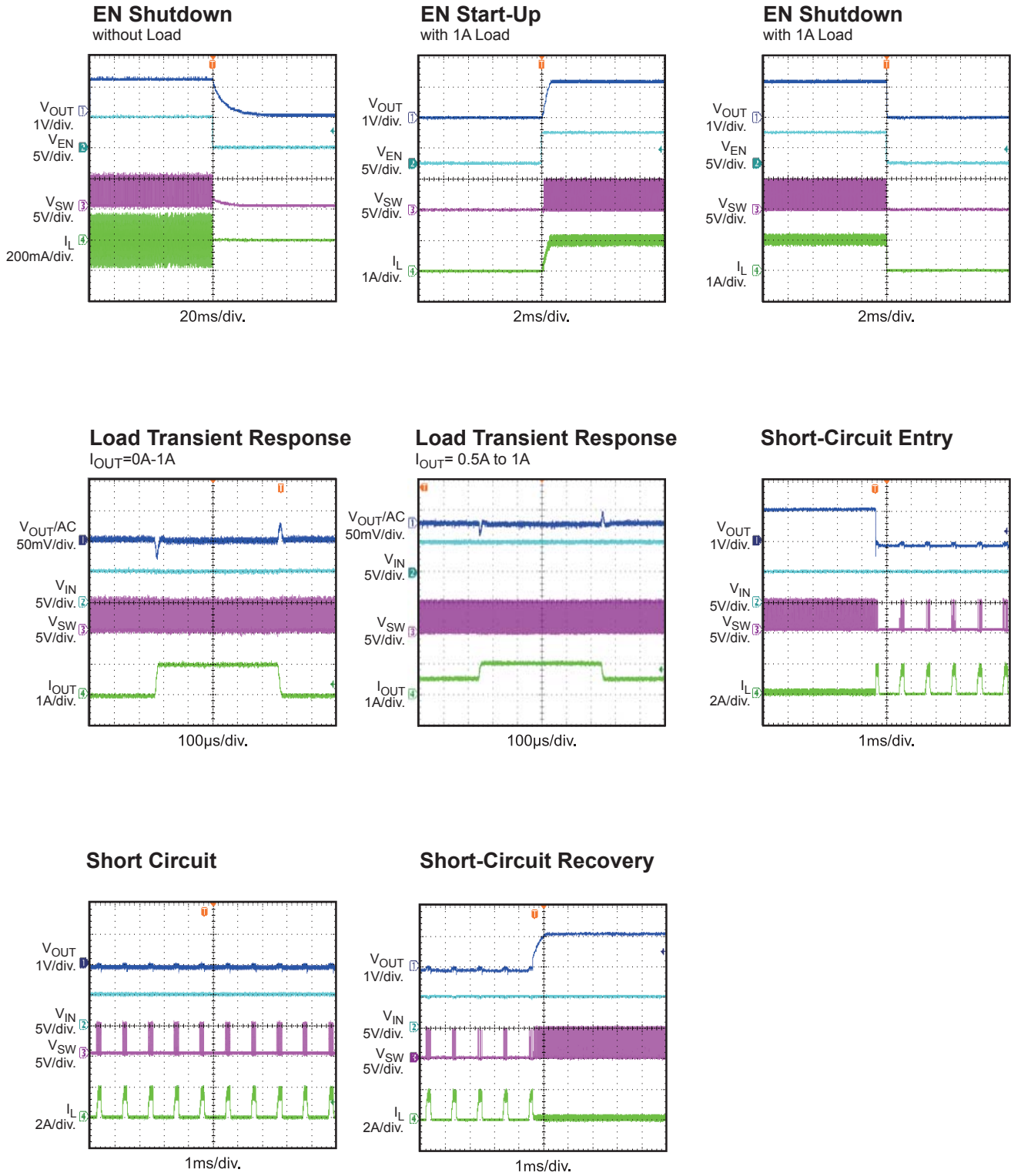
**Line Regulation vs.  $I_{OUT}$** 

**Case Temperature Rise vs. Output Current**

**Quiescent Current vs. Input Voltage**

**Quiescent Current vs. Temperature**

 **$V_{IN}$  UVLO Rising and Falling Threshold vs. Temperature**

**EN Rising and Falling Threshold vs. Temperature**

**TYPICAL PERFORMANCE CHARACTERISTICS (continued)**
 **$V_{IN} = 5V$ ,  $V_{OUT} = 1.2V$ ,  $L = 1.0\mu H$ ,  $C_{OUT} = 10\mu F$ ,  $T_A = +25^\circ C$ , unless otherwise noted.**
**Switch Frequency vs. Temperature**

**Reference Voltage vs. Temperature**

**Current Limit vs. Temperature**

**Current Limit vs. Input Voltage**

**Shutdown Current vs. Input Voltage**

**TYPICAL PERFORMANCE CHARACTERISTICS (continued)**
 **$V_{IN} = 5V$ ,  $V_{OUT} = 1.2V$ ,  $L = 1.0\mu H$ ,  $C_{OUT} = 10\mu F$ ,  $T_A = +25^\circ C$ , unless otherwise noted.**
**Steady State**  
without Load

**Steady State**  
with 1A Load

**Steady State**  
 $V_{IN}=3.6V$ ,  $V_{OUT}=3.3V$ , without Load

**Steady State**  
 $V_{IN}=3.6V$ ,  $V_{OUT}=3.3V$ ,  $I_{OUT}=1A$ 

**VIN Power-Up**  
without Load

**VIN Shutdown**  
without Load

**VIN Power-Up**  
with 1A Load

**VIN Shutdown**  
with 1A Load

**EN Start-Up**  
without Load

**TYPICAL PERFORMANCE CHARACTERISTICS (continued)**
 **$V_{IN} = 5V$ ,  $V_{OUT} = 1.2V$ ,  $L = 1.0\mu H$ ,  $C_{OUT} = 10\mu F$ ,  $T_A = +25^\circ C$ , unless otherwise noted.**



**PIN FUNCTIONS**

Pin #	Name	Description
1	FB	<b>Feedback.</b> An external resistor divider from the output to GND tapped to FB sets the output voltage.
2	GND	<b>Power ground.</b>
3	VIN	<b>Supply voltage.</b> The MP1601A operates from a 2.3V to 5.5V unregulated input. A decoupling capacitor is needed to prevent large voltage spikes from appearing at the input.
4	SW	<b>Output switching node.</b> SW is the drain of the internal, high-side, P-channel MOSFET. Connect the inductor to SW to complete the converter.
5	EN	<b>On/off control.</b>
6	OUT	<b>Output voltage power rail and input sense pin for the output voltage.</b> Connect the load to OUT. An output capacitor is needed to decrease the output voltage ripple.

### BLOCK DIAGRAM

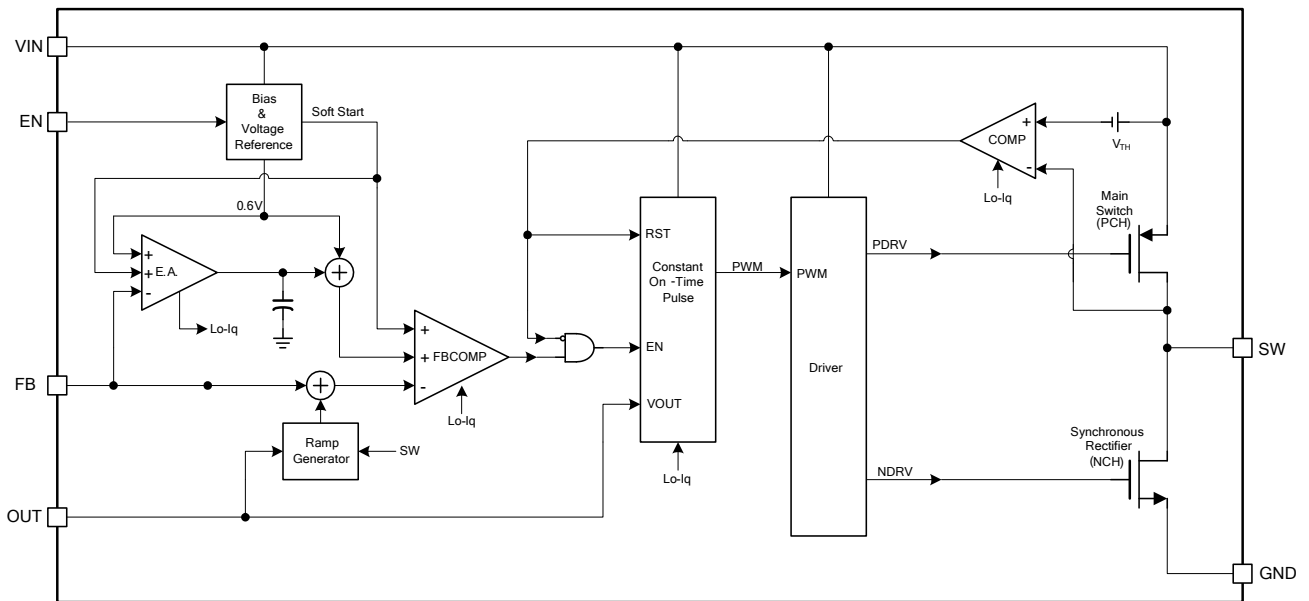

Figure 1: Functional Block Diagram

## OPERATION

The MP1601A uses constant on-time control with input voltage feed-forward to stabilize the switching frequency over the full input range. It achieves 1A of continuous output current from a 2.3V to 5.5V input voltage range with excellent load and line regulation. The output voltage can be regulated as low as 0.6V.

### Constant-on-Time (COT) Control

Compared to fixed-frequency pulse-width modulation (PWM) control, constant-on-time control (COT) offers a simpler control loop and a faster transient response. By using input voltage feed-forward, the MP1601A maintains a nearly constant switching frequency across the input and output voltage ranges. The switching pulse on time can be estimated with Equation (1):

$$T_{ON} = \frac{V_{OUT}}{V_{IN}} \cdot 0.454\mu\text{s} \quad (1)$$

To prevent inductor current runaway during the load transient, the MP1601A uses a fixed minimum off time of 60ns.

### Enable (EN)

When the input voltage is greater than the under-voltage lockout (UVLO) threshold (typically 2V), the MP1601A can be enabled by pulling EN higher than 1.2V. Floating EN or pulling it down to ground disables the MP1601A. There is an internal 1MΩ resistor from EN to ground.

When the device is disabled, the MP1601A goes into output discharge mode automatically. Its internal discharge MOSFET provides a resistive discharge path for the output capacitor.

### Soft Start (SS)

The MP1601A has a built-in soft start (SS) that ramps up the output voltage at a controlled slew rate to avoid overshooting at start-up. The soft-start time is about 0.5ms, typically.

### Current Limit

The MP1601A has a 2A, high-side, switch current limit, typically. When the high-side switch reaches its current limit, the MP1601A remains in hiccup mode until the current drops. This prevents the inductor current from continuing to rise and damaging components.

### Short Circuit and Recovery

The MP1601A enters short-circuit protection (SCP) mode when it reaches the current limit and attempts to recover with hiccup mode. In this process, the MP1601A disables the output power stage, discharges the soft-start capacitor, and then attempts to soft start automatically. If the short-circuit condition remains after the soft start ends, the MP1601A repeats this cycle until the short circuit disappears and the output rises back to regulation levels.

## APPLICATION INFORMATION

### Setting the Output Voltage

The external resistor divider sets the output voltage (see the Typical Application on page 14). Select the feedback resistor (R1) to reduce the  $V_{OUT}$  leakage current, typically between 100k $\Omega$  to 200k $\Omega$ . There is no strict requirement on the feedback resistor.  $R1 > 10k\Omega$  is reasonable for the application. R2 can then be calculated with Equation (2):

$$R2 = \frac{R1}{\frac{V_{out}}{0.6} - 1} \quad (2)$$

Figure 2 shows the feedback circuit.

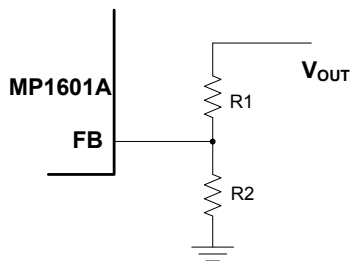

**Figure 2: Feedback Network**

Table 1 lists the recommended resistor values for common output voltages.

**Table 1: Resistor Values for Common Output Voltages**

$V_{OUT}$ (V)	R1 (k $\Omega$ )	R2 (k $\Omega$ )
1.0	200 (1%)	300 (1%)
1.2	200 (1%)	200 (1%)
1.8	200 (1%)	100 (1%)
2.5	200 (1%)	63.2 (1%)
3.3	200 (1%)	44.2 (1%)

### Selecting the Inductor

Most applications work best with a 0.47 $\mu$ H to 2.2 $\mu$ H inductor. Select an inductor with a DC resistance less than 50m $\Omega$  to optimize efficiency.

High-frequency, switch-mode power supplies with a magnetic device have strong electronic magnetic inference for the system. Any unshielded power inductor should be avoided since it has poor magnetic shielding. Metal alloy or multiplayer chip power shield inductors are recommended for the application since they can decrease influence effectively.

Table 2 lists some recommended inductors.

**Table 2: Suggested Inductor List**

Manufacturer P/N	Inductance ( $\mu$ H)	Manufacturer
PIFE25201B-1R0MS	1.0	CYNTEC CO. LTD.
1239AS-H-1R0M	1.0	Tokyo
74438322010	1.0	Würth

For most designs, the inductance can be estimated with Equation (3)

$$L_1 = \frac{V_{OUT} \times (V_{IN} - V_{OUT})}{V_{IN} \times \Delta I_L \times f_{OSC}} \quad (3)$$

Where  $\Delta I_L$  is the inductor ripple current.

Choose the inductor current to be approximately 30% of the maximum load current. The maximum inductor peak current can be calculated with Equation (4):

$$I_{L(MAX)} = I_{LOAD} + \frac{\Delta I_L}{2} \quad (4)$$

### Selecting the Input Capacitor

The input current to the step-down converter is discontinuous and therefore requires a capacitor to supply AC current to the step-down converter while maintaining the DC input voltage. Use low ESR capacitors for the best performance. Ceramic capacitors with X5R or X7R dielectrics are highly recommended because of their low ESR and small temperature coefficients. For most applications, a 10 $\mu$ F capacitor is sufficient. Higher output voltages may require a 22 $\mu$ F capacitor to increase system stability.

The input capacitor requires an adequate ripple current rating since it absorbs the input switching current. Estimate the RMS current in the input capacitor with Equation (5):

$$I_{C1} = I_{LOAD} \times \sqrt{\frac{V_{OUT}}{V_{IN}} \times \left(1 - \frac{V_{OUT}}{V_{IN}}\right)} \quad (5)$$

The worst-case scenario occurs at  $V_{IN} = 2V_{OUT}$ , shown in Equation (6):

$$I_{C1} = \frac{I_{LOAD}}{2} \quad (6)$$

For simplification, choose an input capacitor with an RMS current rating greater than half of the maximum load current.

The input capacitor can be electrolytic, tantalum, or ceramic. When using electrolytic or tantalum capacitors, add a small, high-quality, 0.1µF, ceramic capacitor as close to the IC as possible. When using ceramic capacitors, ensure that they have enough capacitance to provide a sufficient charge to prevent excessive voltage ripple at the input. The input voltage ripple caused by capacitance can be estimated with Equation (7):

$$\Delta V_{IN} = \frac{I_{LOAD}}{f_s \times C1} \times \frac{V_{OUT}}{V_{IN}} \times \left(1 - \frac{V_{OUT}}{V_{IN}}\right) \quad (7)$$

### Selecting the Output Capacitor

The output capacitor (C2) stabilizes the DC output voltage. Low ESR ceramic capacitors are recommended to limit the output voltage ripple. Estimate the output voltage ripple with Equation (8):

$$\Delta V_{OUT} = \frac{V_{OUT}}{f_s \times L_1} \times \left(1 - \frac{V_{OUT}}{V_{IN}}\right) \times \left(R_{ESR} + \frac{1}{8 \times f_s \times C2}\right) \quad (8)$$

Where  $L_1$  is the inductor value, and  $R_{ESR}$  is the equivalent series resistance (ESR) value of the output capacitor.

When using ceramic capacitors, the capacitance dominates the impedance at the switching frequency and causes most of the output voltage ripple. For simplification, the output voltage ripple can be estimated with Equation (9):

$$\Delta V_{OUT} = \frac{V_{OUT}}{8 \times f_s^2 \times L_1 \times C2} \times \left(1 - \frac{V_{OUT}}{V_{IN}}\right) \quad (9)$$

For tantalum or electrolytic capacitors, the ESR dominates the impedance at the switching frequency. For simplification, the output ripple can be approximated with Equation (10):

$$\Delta V_{OUT} = \frac{V_{OUT}}{f_s \times L_1} \times \left(1 - \frac{V_{OUT}}{V_{IN}}\right) \times R_{ESR} \quad (10)$$

The characteristics of the output capacitor also affect the stability of the regulation system.

### PCB Layout Guidelines

Efficient layout of the switching power supplies is critical for stable operation. For the high-frequency switching converter, poor layout design can result in poor line or load regulation and stability issues. For best results, refer to Figure 3 and follow the guidelines below.

1. Place the high-current paths (GND, VIN and SW) as close to the device as possible with short, direct, and wide traces.
2. Place the input capacitor as close to VIN and GND as possible.
3. Place the external feedback resistors next to FB.
4. Keep the switching node (SW) short and away from the feedback network.
5. Keep the  $V_{OUT}$  sense line as short as possible or away the from power inductor and surrounding inductors.

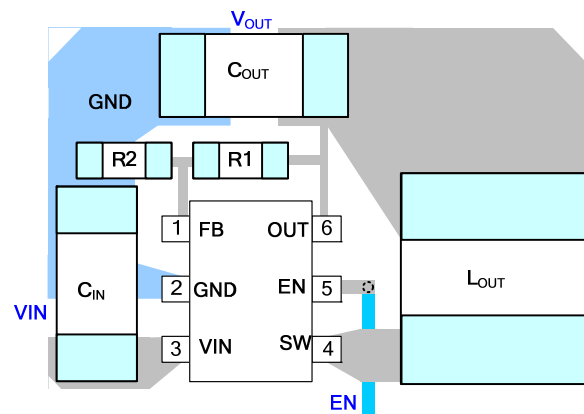

**Figure 3: Two Ends of Input Decoupling Capacitor Close to Pin 2 and Pin 3**

TYPICAL APPLICATION CIRCUITS

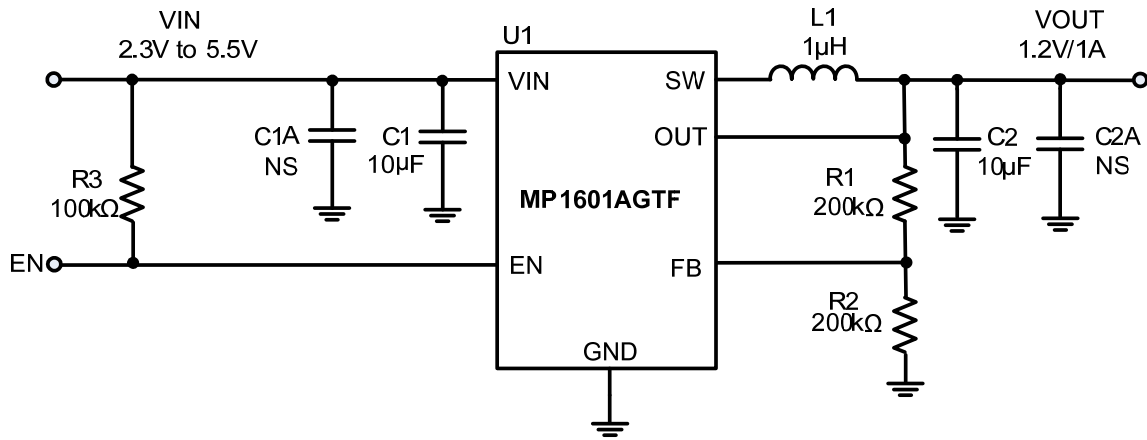
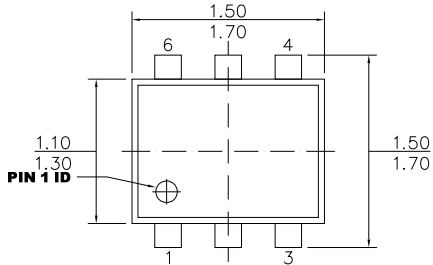

Figure 4: Typical Application Circuit

NOTE:  $V_{IN} < 3.3V$  may require more input capacitors.

## PACKAGE INFORMATION

### SOT563



**TOP VIEW**

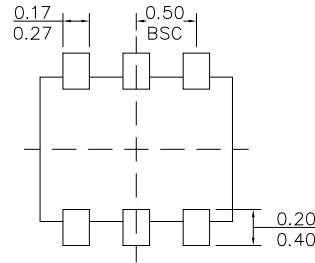

**BOTTOM VIEW**



**FRONT VIEW**

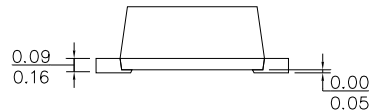

**SIDE VIEW**

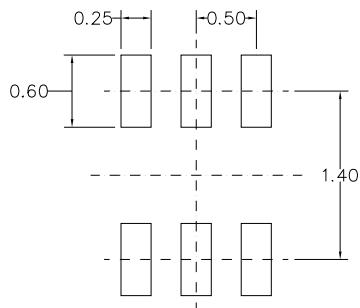

**RECOMMENDED LAND PATTERN**

**NOTE:**

- 1) ALL DIMENSIONS ARE IN MILLIMETERS.
- 2) PACKAGE LENGTH DOES NOT INCLUDE MOLD FLASH, PROTRUSION OR GATE BURR.
- 3) PACKAGE WIDTH DOES NOT INCLUDE INTERLEAD FLASH OR PROTRUSION.
- 4) LEAD COPLANARITY (BOTTOM OF LEADS AFTER FORMING) SHALL BE 0.10 MILLIMETERS MAX.
- 5) DRAWING IS NOT TO SCALE.

**NOTICE:** The information in this document is subject to change without notice. Please contact MPS for current specifications. Users should warrant and guarantee that third party Intellectual Property rights are not infringed upon when integrating MPS products into any application. MPS will not assume any legal responsibility for any said applications.