

LPDDR3 SDRAM

**8M x 16 Bit x 8 Banks
LPDDR3 SDRAM**

Feature

- Ultra-low-voltage core and I/O power supplies
 - $V_{DD1} = 1.70\text{--}1.95\text{V}$
 - $V_{DD2}, V_{DDCA}, V_{DDQ} = 1.14\text{--}1.30\text{V}$
- Organization
 - 8M words x 16 bits x 8 banks
- JEDEC LPDDR3-compliant
- 4KB page size
 - Row address: R0-R12
 - Column address: C0-C9 (x16 bits)
- Auto precharge option for each burst access
- Eight-bit prefetch DDR architecture
- Eight internal banks for concurrent operation
- Double data rate, command/address inputs; commands entered on each CK edge
- Bidirectional/differential data strobe per byte of data (DQS)
- Differential clock inputs (CK_t and CK_c)
- Data mask (DM) for write data
- Command/Address (CA) training for CA input timing adjustment
- Write leveling for clock to DQ, DQS, and DM timing adjustment
- Interface: HSUL_12
- Read latency (RL): 3, 6, 8, 9, 10, 11, 12, 14, 16
- Burst length (BL): 8
- Burst type (BT): Sequential
- Per-bank refresh for concurrent operation
- Auto temperature compensated self refresh (ATCSR)
- Auto refresh and self refresh
- Refresh cycles: 4,096 cycles/32ms
 - Average refresh period: 7.8 μ s
- Partial-array self refresh (PASR)
 - Bank masking
 - Segment masking
- Deep power-down (DPD)
- Programmable drive strength (DS)
- On-die termination (ODT)

Ordering Information

Product ID	Max Freq. (MHz)	Data Rate (Mb/s/pin)	RL	WL	$V_{DD1} / V_{DD2}, V_{DDCA}, V_{DDQ}$	Package	Comments
M55D1G1664A-GFBG2Y	1066	2133	16	8	1.8V / 1.2V	178 ball BGA	Pb-free
M55D1G1664A-EEBG2Y	933	1866	14	8			
M55D1G1664A-CDBG2Y	800	1600	12	6			

LPDDR3 SDRAM Addressing

Items	1 Gb (64 Mb x16)
Device Type	S4
Number of Banks	8
Bank Addresses	BA0-BA2
t_{REFI} (us) ^{*2}	7.8
Row Addresses	R0-R12
Column Addresses ^{*1}	C0-C9

Notes:

1. The least-significant column address C0 is not transmitted on the CA bus, and is implied to be zero.
2. t_{REFI} values for all bank refresh is within temperature specification ($T_{CASE} \leq 85^{\circ}C$).
3. Row and Column Address values on the CA bus that are not used are "don't care".

Block Diagram

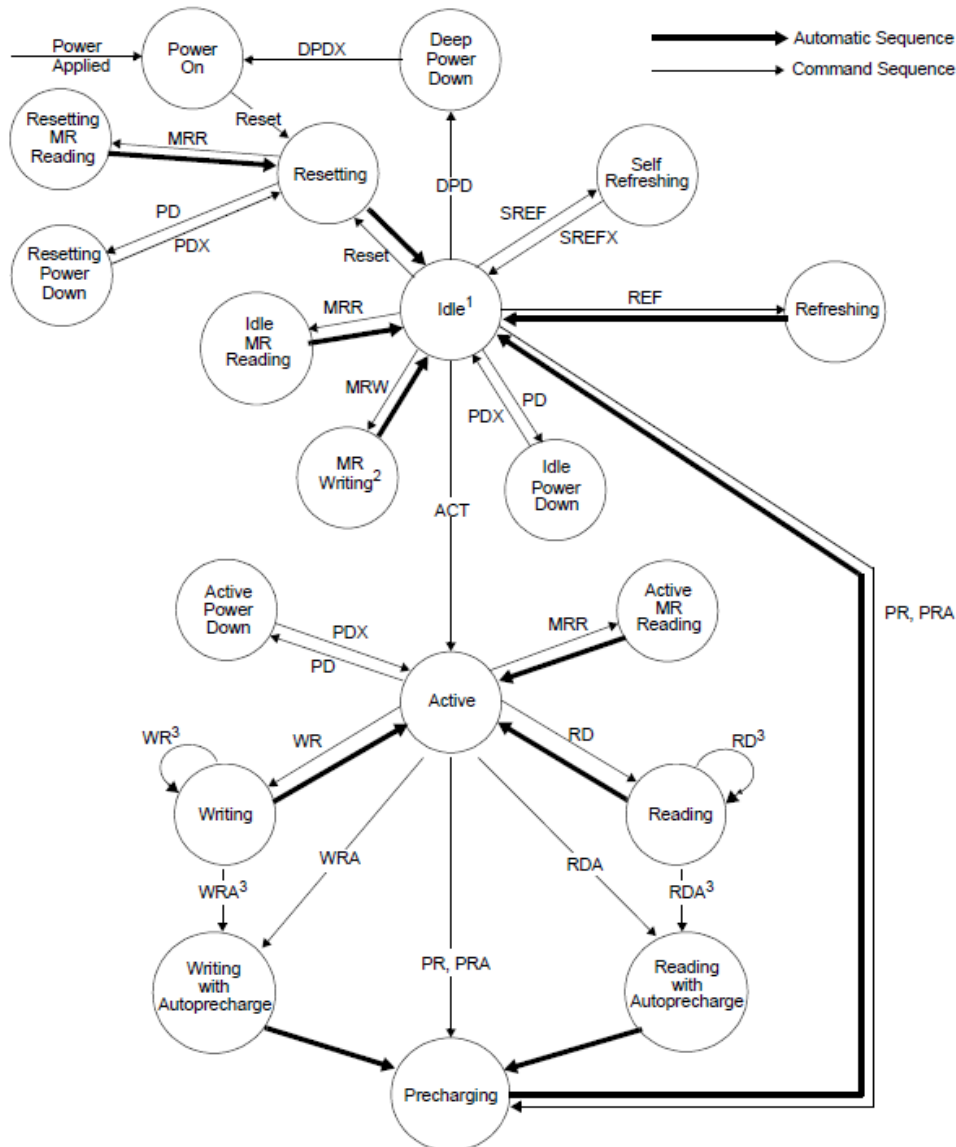

ACT = Activate
 PR(A) = Precharge (All)
 WR(A) = Write (with Autoprecharge)
 RD(A) = Read (with Autoprecharge)
 MRW = Mode Register Write
 MRR = Mode Register Read
 Reset = Reset is achieved through MRW command

PD = Enter Power Down
 PDX = Exit Power Down
 SREF = Enter Self Refresh
 SREFX = Exit Self Refresh
 DPD = Enter Deep Power Down
 DPDX = Exit Deep Power Down
 REF = Refresh

Simplified Bus Interface State Diagram

Note:

1. In the Idle state, all banks are precharged.
2. In the case of MRW to enter CA Training mode or Write Leveling Mode, the state machine will not automatically return to the Idle state. In these cases an additional MRW command is required to exit either operating mode and return to the Idle state. See sections "CA Training" or "Write Leveling".
3. Terminated bursts are not allowed. For these state transitions, the burst operation must be completed before the transition can occur.
4. Use caution with this diagram. It is intended to provide a floorplan of the possible state transitions and commands to control them, not all details. In particular, situations involving more than one bank are not captured in full detail.

BALL CONFIGURATION (TOP VIEW)

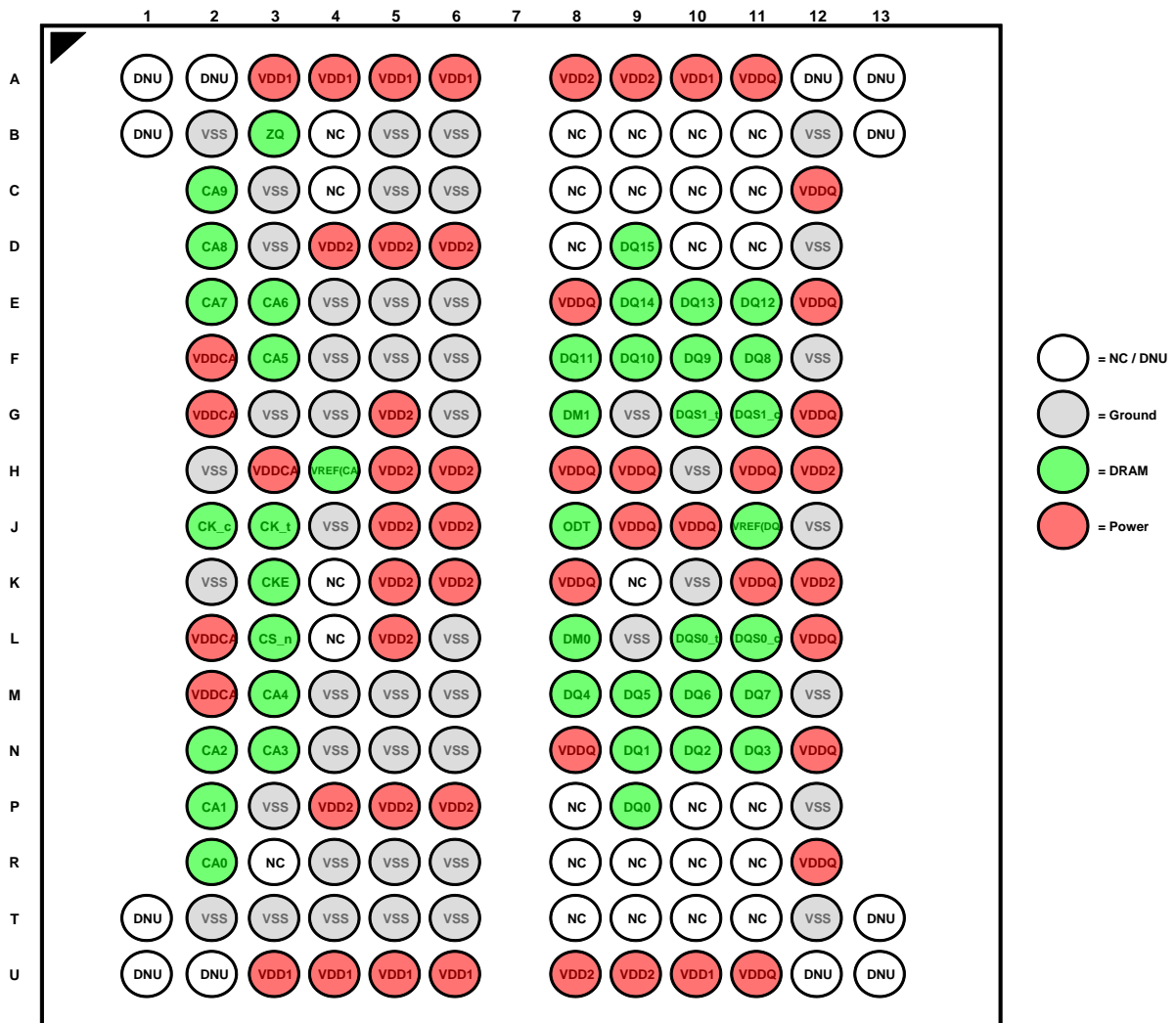

Ball Descriptions

Ball Name	Type	Function
CK_t, CK_c	Input	<p>Clock: CK_t and CK_c are differential clock inputs. All Double Data Rate (DDR) CA inputs are sampled on both positive and negative edge of CK_t. Single Data Rate (SDR) inputs, CS_n and CKE, are sampled at the positive Clock edge.</p> <p>Clock is defined as the differential pair, CK_t and CK_c. The positive Clock edge is defined by the crosspoint of a rising CK_t and a falling CK_c. The negative Clock edge is defined by the crosspoint of a falling CK_t and a rising CK_c.</p>
CKE	Input	<p>Clock Enable: CKE HIGH activates and CKE LOW deactivates internal clock signals and therefore device input buffers and output drivers. Power savings modes are entered and exited through CKE transitions. CKE is considered part of the command code. CKE is sampled at the positive Clock edge.</p>
CS_n	Input	<p>Chip Select: CS_n is considered part of the command code and CS_n is sampled at the positive Clock edge.</p>
CA[n:0]	Input	<p>DDR Command/Address Inputs: Uni-directional command/address bus inputs. CA is considered part of the command code.</p>
DQ[n:0]	I/O	<p>Data Inputs/Output: Bi-directional data bus. n=15 for 16 bits DQ.</p>
DQS[n:0]_t, DQS[n:0]_c	I/O	<p>Data Strobe (Bi-directional, Differential):</p> <p>The data strobe is bi-directional (used for read and write data) and differential (DQS_t and DQS_c). It is output with read data and input with write data. DQS_t is edge-aligned to read data and centered with write data.</p> <p>DQS0_t and DQS0_c correspond to the data on DQ0 - DQ7; DQS1_t and DQS1_c to the data on DQ8 - DQ15.</p>
DM[n:0]	Input	<p>Input Data Mask:</p> <p>DM is the input mask signal for write data. Input data is masked when DM is sampled HIGH coincident with that input data during a Write access. DM is sampled on both edges of DQS_t. Although DM is for input only, the DM loading shall match the DQ and DQS_t (or DQS_c).</p> <p>DM0 is the input data mask signal for the data on DQ0-7, DM1 is the input data mask signal for the data on DQ8-15.</p>
ODT	Input	<p>On-Die Termination: This signal enables and disables termination on the DRAM DQ bus according to the specified mode register settings.</p>

Ball Name	Type	Function
VDD1	Supply	Core power supply 1: Core power supply.
VDD2	Supply	Core power supply 2: Core power supply
VDDCA	Supply	Input Receiver Power Supply: Power supply for CA[n:0], CKE, CS_n, CK_t, and CK_c input buffers.
VDDQ	Supply	I/O Power Supply: Power supply for Data input/output buffers.
VREF(CA)	Supply	Reference Voltage for CA Command and Control Input Receiver: Reference voltage for all CA[n:0], CKE, CS_n, CK_t, and CK_c input buffers.
VREF(DQ)	Supply	Reference Voltage for DQ Input Receiver: Reference voltage for all Data input buffers.
VSS	Supply	Ground.
VSSCA	Supply	Ground for Input Receivers.
VSSQ	Supply	I/O Ground.
ZQ	I/O	Reference Pin for Output Drive Strength Calibration.
NC / DNU	-	No Connection / Do Not Use

Notes: Data includes DQ and DM.

Power-up, Initialization, and Power-off

Voltage Ramp and Device Initialization

The following sequence must be used to power up the device. Unless specified otherwise, this procedure is mandatory.

1. Voltage Ramp: While applying power (after T_a), CKE must be held LOW ($\leq 0.2 \times V_{DDCA}$) and all other inputs must be between V_{Lmin} and V_{IHmax} . The device outputs remain at High-Z while CKE is held LOW.

Following the completion of the voltage ramp (T_b), CKE must be maintained LOW. DQ, DM, DQS_t and DQS_c voltage levels must be between V_{SSQ} and V_{DDQ} during voltage ramp to avoid latchup. CK_t, CK_c, CS_n, and CA input levels must be between V_{SSCA} and V_{DDCA} during voltage ramp to avoid latch-up. Voltage ramp power supply requirements are provided in Voltage Ramp Conditions table.

Voltage Ramp Conditions

After...	Applicable Conditions
Ta is reached	V_{DD1} must be greater than $V_{DD2} - 200$ mV
	V_{DD1} and V_{DD2} must be greater than $V_{DDCA} - 200$ mV
	V_{DD1} and V_{DD2} must be greater than $V_{DDQ} - 200$ mV
	V_{Ref} must always be less than all other supply voltages

Note:

1. T_a is the point when any power supply first reaches 300 mV.
2. Noted conditions apply between T_a and power-off (controlled or uncontrolled).
3. T_b is the point at which all supply and reference voltages are within their defined operating ranges.
4. Power ramp duration t_{INIT0} ($T_b - T_a$) must not exceed 20 ms.
5. The voltage difference between any of V_{SS} , V_{SSQ} , and V_{SSCA} pins must not exceed 100 mV.

Beginning at T_b , CKE must remain LOW for at least t_{INIT1} , after which CKE can be asserted HIGH. The clock must be stable at least t_{INIT2} prior to the first CKE LOW-to-HIGH transition (T_c). CKE, CS_n, and CA inputs must observe setup and hold requirements (t_{IS} , t_{IH}) with respect to the first rising clock edge (as well as to subsequent falling and rising edges).

If any MRR commands are issued, the clock period must be within the range defined for t_{CKb} . MRW commands can be issued at normal clock frequencies as long as all AC timings are met. Some AC parameters (for example, t_{DQSCk}) could have relaxed timings (such as t_{DQSCkb}) before the system is appropriately configured. While keeping CKE HIGH, NOP commands must be issued for at least t_{INIT3} (T_d). The ODT input signal may be in undefined state until t_{IS} before CKE is registered HIGH. When CKE is registered HIGH, the ODT input signal shall be statically held at either LOW or HIGH. The ODT input signal remains static until the power up initialization sequence is finished, including the expiration of t_{ZQINIT} .

2. RESET Command: After t_{INIT3} is satisfied, the MRW RESET command must be issued (T_d).

An optional PRECHARGE ALL command can be issued prior to the MRW RESET command. Wait at least t_{INIT4} while keeping CKE asserted and issuing NOP commands. Only NOP commands are allowed during time t_{INIT4} .

3. MRRs and Device Auto Initialization (DAI) Polling: After t_{INIT4} is satisfied (T_e), only MRR commands and power-down entry/exit commands are supported. After T_e , CKE can go LOW in alignment with power-down entry and exit specifications. MRR commands are only valid at this time if the CA bus does not need to be trained. CA Training may only begin after time T_f . User may issue MRR command to poll the DAI bit which will indicate if device auto initialization is complete; once DAI bit indicates completion, SDRAM is in idle state. Device will also be in idle state after $t_{INIT5(max)}$ has expired (whether or not DAI bit has been read by MRR command). As the memory output buffers are not properly configured by T_e , some AC parameters must have relaxed timings before the system is appropriately configured.

After the DAI bit (MR0, DAI) is set to zero by the memory device (DAI complete), the device is in the idle state (T_f).

DAI status can be determined by issuing the MRR command to MR0. The device sets the DAI bit no later than t_{INIT5} after the RESET command. The controller must wait at least $t_{INIT5(max)}$ or until the DAI bit is set before proceeding.

4. ZQ Calibration: If CA Training is not required, the MRW initialization calibration (ZQ_CAL) command can be issued to the memory (MR10) after time Tf. If CA Training is required, the CA Training may begin at time Tf. See “Mode Register Write - CA Training Mode” for the CA Training command. No other CA commands (other than RESET or NOP) may be issued prior to the completion of CA Training. At the completion of CA Training (Tf'), the MRW initialization calibration (ZQ_CAL) command can be issued to the memory (MR10).

This command is used to calibrate output impedance over process, voltage, and temperature. In systems where more than one LPDDR3 device exists on the same bus, the controller must not overlap MRW ZQ_CAL commands. The device is ready for normal operation after t_{ZQINIT}.

5. Normal Operation: After t_{ZQINIT} (Tg), MRW commands must be used to properly configure the memory (for example the output buffer drive strength, latencies, etc.). Specifically, MR1, MR2, and MR3 must be set to configure the memory for the target frequency and memory configuration.

After the initialization sequence is complete, the device is ready for any valid command. After Tg, the clock frequency can be changed using the procedure described in the LPDDR3 specification.

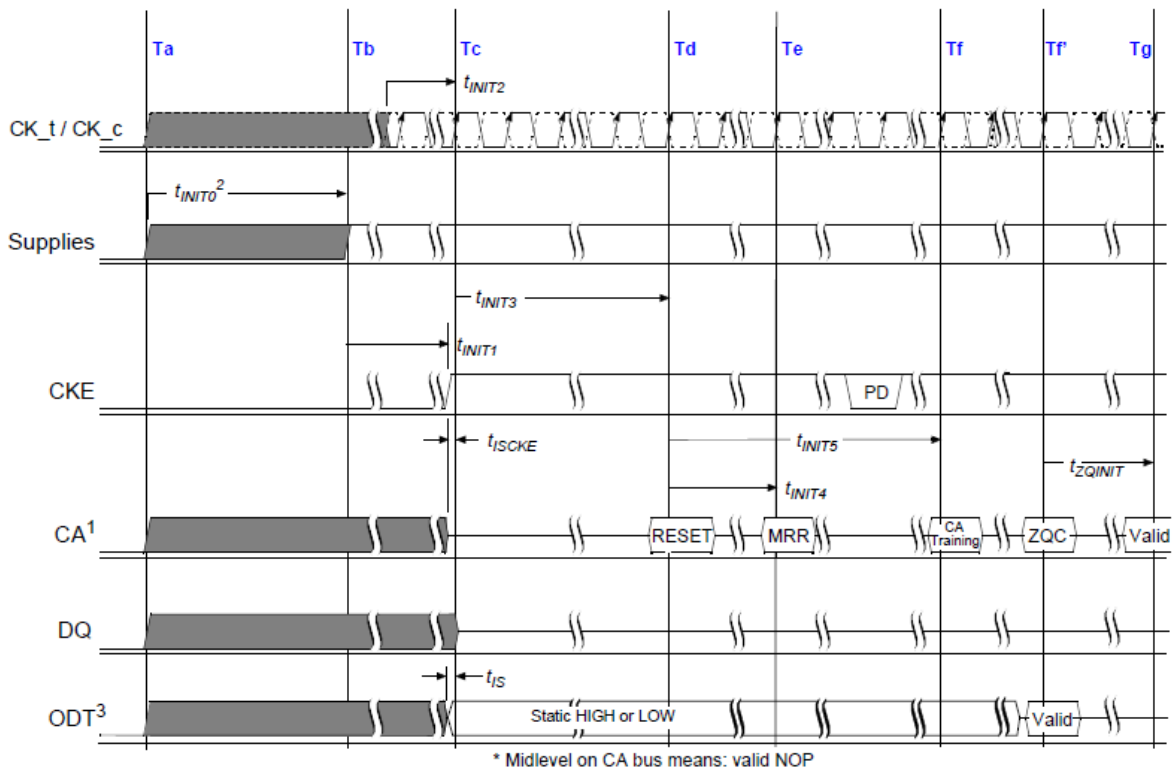

Voltage Ramp and Initialization Sequence

Note:

1. High-Z on the CA bus indicates NOP.
2. For t_{INIT} values, see Initialization Timing Parameters table.
3. After RESET command (time Te), R_{TT} is disabled until ODT function is enabled by MRW to MR11 following Tg.
4. CA Training is optional.

Initialization Timing Parameters

Parameter	Value		Unit	Comment
	Min	Max		
t_{INIT0}	–	20	ms	Maximum voltage-ramp time
t_{INIT1}	100	–	ns	Minimum CKE LOW time after completion of voltage ramp
t_{INIT2}	5	–	t_{CK}	Minimum stable clock before first CKE HIGH
t_{INIT3}	200	–	μ s	Minimum idle time after first CKE assertion
t_{INIT4}	1	–	μ s	Minimum idle time after RESET command
$t_{INIT5}^{1)}$	–	10	μ s	Maximum duration of device auto initialization
t_{ZQINIT}	1	–	μ s	ZQ initial calibration
t_{CKb}	18	100	ns	Clock cycle time during boot

Note: 1. If DAI bit is not read via MRR, SDRAM will be in idle state after $t_{INIT5(max)}$ has expired.

Initialization After RESET (without voltage ramp):

If the RESET command is issued before or after the power-up initialization sequence, the re-initialization procedure must begin at T_d .

Power-off Sequence

The following procedure is required to power off the device.

While powering off, CKE must be held LOW ($\leq 0.2 \times V_{DDCA}$); all other inputs must be between V_{Lmin} and V_{Hmax} .

The device outputs remain at High-Z while CKE is held LOW.

DQ, DM, DQS_t, and DQS_c voltage levels must be between V_{SSQ} and V_{DDQ} during the power-off sequence to avoid latch-up. CK_t, CK_c, CS_n, and CA input levels must be between V_{SSCA} and V_{DDCA} during the power-off sequence to avoid latch-up.

Tx is the point where any power supply drops below the minimum value specified.

Tz is the point where all power supplies are below 300mV. After Tz, the device is powered off.

Power Supply Conditions

Between...	Applicable Conditions
Tx and Tz	V_{DD1} must be greater than $V_{DD2}-200mV$
	V_{DD1} must be greater than $V_{DDCA}-200mV$
	V_{DD1} must be greater than $V_{DDQ}-200mV$
	V_{REF} must always be less than all other supply voltages

The voltage difference between any of V_{SS} , V_{SSQ} , and V_{SSCA} pins must not exceed 100mV

Uncontrolled Power-Off Sequence

When an uncontrolled power-off occurs, the following conditions must be met:

At Tx, when the power supply drops below the minimum values specified, all power supplies must be turned off and all power-supply current capacity must be at zero, except for any static charge remaining in the system.

After Tz (the point at which all power supplies first reach 300mV), the device must power off. During this period, the relative voltage between power supplies is uncontrolled. V_{DD1} and V_{DD2} must decrease with a slope lower than $0.5 V/\mu s$ between Tx and Tz.

An uncontrolled power-off sequence can occur a maximum of 400 times over the life of the device.

Timing Parameters Power-Off

Parameter	Value		Unit	Comment
	Min	Max		
t _{POFF}	–	2	s	Maximum Power-off ramp time

Mode Register Definition

Mode Register Assignment and Definition in LPDDR3 SDRAM

Mode Register Assignment in LPDDR3 SDRAM table shows the mode registers for LPDDR3 SDRAM. Each register is denoted as “R” if it can be read but not written, “W” if it can be written but not read, and “R/W” if it can be read and written. A Mode Register Read command is used to read a mode register. A Mode Register Write command is used to write a mode register.

Mode Register Assignment in LPDDR3 SDRAM

MR#	MA <7:0>	Function	Access	OP7	OP6	OP5	OP4	OP3	OP2	OP1	OP0
0	00H	Device Info.	R	RL3	WL (Set B)	(RFU)	RZQI (optional)	(RFU)	(RFU)		DAI
1	01H	Device Feature 1	W	nWR (for AP)			(RFU)	BL			
2	02H	Device Feature 2	W	WR Lev	WL Select	(RFU)	nWRE	RL & WL			
3	03H	I/O Config-1	W	(RFU)				DS			
4	04H	Refresh Rate	R	TUF	(RFU)				Refresh Rate		
5	05H	Basic Config-1	R	LPDDR3 Manufacturer ID							
6	06H	Basic Config-2	R	Revision ID1							
7	07H	Basic Config-3	R	Revision ID2							
8	08H	Basic Config-4	R	I/O width		Density				Type	
9	09H	Test Mode	W	Vendor-Specific Test Mode							
10	0AH	IO Calibration	W	Calibration Code							
11	0BH	ODT Feature		(RFU)					PD CTL	DQ ODT	
12:15	0CH-0FH	(reserved)		(RFU)							
16	10H	PASR_Bank	W	PASR Bank Mask							
17	11H	PASR_Seg	W	PASR Segment Mask							
18-31	12H-1FH	(Reserved)		(RFU)							
32	20H	DQ Calibration Pattern A	R	See “DQ Calibration”							
33:39	21H-27H	(Do Not Use)									
40	28H	DQ Calibration Pattern B	R	See “DQ Calibration”							
41	29H	CA Training 1	W	See “Mode Register Write - CA Training Mode”							
42	2AH	CA Training 2	W	See “Mode Register Write - CA Training Mode”							
43:47	2BH-2FH	(Do Not Use)									
48	30H	CA Training 3	W	See “Mode Register Write - CA Training Mode”							
49:62	31H-3EH	(Reserved)		(RFU)							
63	3FH	Reset	W	X							
64:255	40H-FFH	(Reserved)		(RFU)							

Note:

- RFU bits shall be set to ‘0’ during mode register writes.
- RFU bits shall be read as ‘0’ during mode register reads.
- All mode registers that are specified as RFU or write-only shall return undefined data when read and DQS_t, DQS_c shall be toggled.

4. All mode registers that are specified as RFU shall not be written.
5. See vendor device datasheets for details on vendor-specific mode registers.
6. Writes to read-only registers shall have no impact on the functionality of the device.

MR0_Device Information (MA<7:0> = 00H):

OP7	OP6	OP5	OP4	OP3	OP2	OP1	OP0
RL3	WL (Set B) Support	(RFU)	RZQI (optional)		(RFU)		DAI

DAI (Device Auto-Initialization Status)	Read-only	OP<0>	0B: DAI complete 1B: DAI still in progress	
RZQI (Built in Self Test for RZQ Information)	Read-only	OP<4:3>	00B: RZQ self test not supported 01B: ZQ-pin may connect to V _{DDCA} or float 10B: ZQ-pin may short to GND 11B: ZQ-pin self test completed, no error condition detected (ZQ-pin may not connect to V _{DDCA} or float nor short to GND)	1-4
WL (Set B) Support	Read-only	OP<6>	0B: DRAM does not support WL (Set B) 1B: DRAM supports WL (SetB)	WL (Set B) Option Support
RL3 Option Support	Read-only	OP<7>	0B: DRAM does not support RL=3, nWR=3, WL=1 1B: DRAM supports RL=3, nWR=3, WL=1 for frequencies ≤ 166	RL3 Option Support

Note:

1. RZQI, if supported, will be set upon completion of the MRW ZQ Initialization Calibration command.
2. If ZQ is connected to V_{DDCA} to set default calibration, OP[4:3] shall be set to 01. If ZQ is not connected to V_{DDCA}, either OP[4:3]=01 or OP[4:3]=10 might indicate a ZQ-pin assembly error. It is recommended that the assembly error is corrected.
3. In the case of possible assembly error (either OP[4:3]=01 or OP[4:3]=10 per Note 4), the LPDDR3 device will default to factory trim settings for RON, and will ignore ZQ calibration commands. In either case, the system may not function as intended.
4. In the case of the ZQ self-test returning a value of 11b, this result indicates that the device has detected a resistor connection to the ZQ pin. However, this result cannot be used to validate the ZQ resistor value or that the ZQ resistor tolerance meets the specified limits (i.e. 240-Ω±1%).

MR1_Device Feature 1 (MA<7:0> = 01H):

OP7	OP6	OP5	OP4	OP3	OP2	OP1	OP0
nWR (for AP)			(RFU)	BL			

BL	Write-only	OP<2:0>	011 _B : BL8 (default) All others: reserved	
nWR	Write-only	OP<7:5>	If nWRE (MR2 OP<4>) = 0: 001 _B : nWR=3 (optional) 100 _B : nWR=6 110 _B : nWR=8 111 _B : nWR=9 If nWRE (MR2 OP<4>) = 1: 000 _B : nWR=10 (default) 001 _B : nWR=11 010 _B : nWR=12 100 _B : nWR=14 110 _B : nWR=16 All others: reserved	1

Note: 1. Programmed value in nWR register is the number of clock cycles which determines when to start internal precharge operation for a write burst with AP enabled. It is determined by $RU(tWR/tCK)$.

Burst Sequence

C2	C1	C0	BL	Burst Cycle Number and Burst Address Sequence							
				1	2	3	4	5	6	7	8
0 _B	0 _B	0 _B	8	0	1	2	3	4	5	6	7
0 _B	1 _B	0 _B		2	3	4	5	6	7	0	1
1 _B	0 _B	0 _B		4	5	6	7	0	1	2	3
1 _B	1 _B	0 _B		6	7	0	1	2	3	4	5

- C0 input is not present on CA bus. It is implied zero.
- The burst address represents C2 - C0.

MR2_Device Feature 2 (MA<7:0> = 02H):

OP7	OP6	OP5	OP4	OP3	OP2	OP1	OP0
WR Lev	WL Select	(RFU)	nWRE	RL & WL			

RL & WL	Write-only	OP<3:0>	<p>If OP<6> =0 (WL Set A, default)</p> <p>0001B: RL = 3 / WL = 1 (≤ 166 MHz, optional¹)</p> <p>0100B: RL = 6 / WL = 3 (≤ 400 MHz)</p> <p>0110B: RL = 8 / WL = 4 (≤ 533 MHz)</p> <p>0111B: RL = 9 / WL = 5 (≤ 600 MHz)</p> <p>1000B: RL = 10 / WL = 6 (≤ 667 MHz, default)</p> <p>1001B: RL = 11 / WL = 6 (≤ 733 MHz)</p> <p>1010B: RL = 12 / WL = 6 (≤ 800 MHz)</p> <p>1100B: RL = 14 / WL = 8 (≤ 933 MHz)</p> <p>1110B: RL = 16 / WL = 8 (≤ 1066 MHz)</p> <p>All others: reserved</p> <p>If OP<6> =1 (WL Set B, optional²)</p> <p>0001B: RL = 3 / WL = 1 (≤ 166 MHz, optional¹)</p> <p>0100B: RL = 6 / WL = 3 (≤ 400 MHz)</p> <p>0110B: RL = 8 / WL = 4 (≤ 533 MHz)</p> <p>0111B: RL = 9 / WL = 5 (≤ 600 MHz)</p> <p>1000B: RL = 10 / WL = 8 (≤ 667 MHz, default)</p> <p>1001B: RL = 11 / WL = 9 (≤ 733 MHz)</p> <p>1010B: RL = 12 / WL = 9 (≤ 800 MHz)</p> <p>1100B: RL = 14 / WL = 11 (≤ 933 MHz)</p> <p>1110B: RL = 16 / WL = 13 (≤ 1066 MHz)</p> <p>All others: reserved</p>	
nWRE	Write-only	OP<4>	<p>0B: enable nWR programming ≤ 9</p> <p>1B: enable nWR programming > 9 (default)</p>	
WL Select	Write-only	OP<6>	<p>0B: Select WL Set A (default)</p> <p>1B: Select WL Set B (optional²)</p>	
WR Leveling	Write-only	OP<7>	<p>0B: disabled (default)</p> <p>1B: enabled</p>	

Note:

1. See MR0, OP<7>
2. See MR0, OP<6>

MR3_I/O Configuration 1 (MA<7:0> = 03H):

OP7	OP6	OP5	OP4	OP3	OP2	OP1	OP0
(RFU)				DS			

DS	Write-only	OP<3:0>	<p>0001B: 34.3Ω typical pull-down/pull-up</p> <p>0010B: 40Ω typical pull-down/pull-up (default)</p> <p>0011B: 48Ω typical pull-down/pull-up</p> <p>0100B: reserved for 60Ω typical pull-down/pull-up</p> <p>0110B: reserved for 80Ω typical pull-down/pull-up</p> <p>1001B: 34.3Ω typical pull-down, 40Ω typical pull-up</p> <p>1010B: 40Ω typical pull-down, 48Ω typical pull-up</p> <p>1011B: 34.3Ω typical pull-down, 48Ω typical pull-up</p> <p>All others: reserved</p>	
----	------------	---------	---	--

MR4_Device Temperature (MA<7:0> = 04H)

OP7	OP6	OP5	OP4	OP3	OP2	OP1	OP0
TUF	(RFU)				SDRAM Refresh Rate		

SDRAM Refresh Rate, Refresh Multiplier (RM)	Read-only	OP<2:0>	<p>000B: SDRAM Low temperature operating limit exceeded</p> <p>001B: RM = 4; $t_{REFIM} = 4 \times t_{REFI}$, $t_{REFIMpb} = 4 \times t_{REFIpb}$, $t_{REFWM} = 4 \times t_{REFW}$</p> <p>010B: RM = 2; $t_{REFIM} = 2 \times t_{REFI}$, $t_{REFIMpb} = 2 \times t_{REFIpb}$, $t_{REFWM} = 2 \times t_{REFW}$</p> <p>011B: RM = 1; $t_{REFIM} = t_{REFI}$, $t_{REFIMpb} = t_{REFIpb}$, $t_{REFWM} = t_{REFW} (<=85^{\circ}C)$</p> <p>100B: RM = 0.5; $t_{REFIM} = 0.5 \times t_{REFI}$, $t_{REFIMpb} = 0.5 \times t_{REFIpb}$, $t_{REFWM} = 0.5 \times t_{REFW}$, do not de-rate SDRAM AC timing</p> <p>101B: RM = 0.25; $t_{REFIM} = 0.25 \times t_{REFI}$, $t_{REFIMpb} = 0.25 \times t_{REFIpb}$, $t_{REFWM} = 0.25 \times t_{REFW}$, do not de-rate SDRAM AC timing</p> <p>110B: RM = 0.25; $t_{REFIM} = 0.25 \times t_{REFI}$, $t_{REFIMpb} = 0.25 \times t_{REFIpb}$, $t_{REFWM} = 0.25 \times t_{REFW}$, de-rate SDRAM AC timing</p> <p>111B: SDRAM High temperature operating limit exceeded</p>
Temperature Update Flag (TUF)	Read-only	OP<7>	<p>0B: OP<2:0> value has not changed since last read of MR4.</p> <p>1B: OP<2:0> value has changed since last read of MR4.</p>

Note:

1. A Mode Register Read from MR4 will reset OP7 to '0'.
2. OP7 is reset to '0' at power-up. OP<2:0> bits are undefined after power-up.
3. If OP2 equals '1', the device temperature is greater than 85°C.
4. OP7 is set to '1' if OP2:OP0 has changed at any time since the last read of MR4. NOTE 5 SDRAM might not operate properly when OP[2:0] = 000B or 111B.
5. For specified operating temperature range and maximum operating temperature refer to Input Leakage Current table.
6. LPDDR3 devices shall be de-rated by adding 1.875 ns to the following core timing parameters: t_{RCD} , t_{RC} , t_{RAS} , t_{RP} , and t_{RRD} . t_{DQCK} shall be de-rated according to the t_{DQCK} de-rating in AC Timing table.
7. Prevailing clock frequency spec and related setup and hold timings shall remain unchanged.
8. See "Temperature Sensor" for information on the recommended frequency of reading MR4.

MR5_Basic Configuration 1 (MA<7:0> = 05H):

OP7	OP6	OP5	OP4	OP3	OP2	OP1	OP0
LPDDR3 Manufacturer ID							

LPDDR3 Manufacturer ID	Read-only	OP<7:0>	See JESD-TBD LPDDR3 Manufacturer ID encodings
------------------------	-----------	---------	--

MR6_Basic Configuration 2 (MA<7:0> = 06H):

OP7	OP6	OP5	OP4	OP3	OP2	OP1	OP0
Revision ID1							

Revision ID1	Read-only	OP<7:0>	00000000 _B : A-version
--------------	-----------	---------	--

Note: 1. MR6 is vendor specific.

MR7_Basic Configuration 3 (MA<7:0> = 07H):

OP7	OP6	OP5	OP4	OP3	OP2	OP1	OP0
Revision ID2							

Revision ID2	Read-only	OP<7:0>	00000000 _B : A-version
--------------	-----------	---------	--

Note: 1 MR7 is vendor specific.

MR8_Basic Configuration 4 (MA<7:0> = 08B_H):

OP7	OP6	OP5	OP4	OP3	OP2	OP1	OP0
I/O width		Density				Type	

Type	Read-only	OP<1:0>	11_B : S8 SDRAM all others : Reserved
Density	Read-only	OP<5:2>	0100_B : 1Gb 0101_B : 2Gb 0110_B : 4Gb 1110_B : 6Gb 0111_B : 8Gb 1101_B : 12Gb 1000_B : 16Gb 1001_B : 32Gb all others : reserved
I/O width	Read-only	OP<7:6>	00_B : x32 01_B : x16 all others : reserved

MR9_Test Mode (MA<7:0> = 09_H):

OP7	OP6	OP5	OP4	OP3	OP2	OP1	OP0
vendor-specific test mode							

MR10_Calibration (MA<7:0> = 0A_H):

OP7	OP6	OP5	OP4	OP3	OP2	OP1	OP0
Calibration Code							

Calibration Code	Write-only	OP<7:0>	0xFF: Calibration command after initialization 0xAB: Long calibration 0x56: Short calibration 0xC3: ZQ Reset others: Reserved
------------------	------------	---------	---

Note:

1. Host processor shall not write MR10 with "Reserved" values
2. LPDDR3 devices shall ignore calibration command when a "Reserved" value is written into MR10.
3. See AC timing table for the calibration latency.
4. If ZQ is connected to V_{SSCA} through RZQ, either the ZQ calibration function (see "Mode Register Write ZQ Calibration Command") or default calibration (through the ZQRESET command) is supported. If ZQ is connected to V_{DDCA}, the device operates with default calibration, and ZQ calibration commands are ignored. In both cases, the ZQ connection shall not change after power is applied to the device.
5. LPDDR3 devices that do not support calibration shall ignore the ZQ Calibration command.
6. Optionally, the MRW ZQ Initialization Calibration command will update MR0 to indicate RZQ pin connection.

MR11_ODT Control (MA<7:0> = 0B_H):

OP7	OP6	OP5	OP4	OP3	OP2	OP1	OP0
RFU					PD CTL	DQ ODT	

DQ ODT	Write-only	OP<1:0>	00_B : Disable (Default) 01_B : RZQ/4 (see Note1) 10_B : RZQ/2 11_B : RZQ/1
PD Control	Write-only	OP<2>	0_B : ODT disabled by DRAM during power down (default) 1_B : ODT enabled by DRAM during power down

Note: 1. RZQ/4 shall be supported for LPDDR3-1866 and LPDDR3-2133 devices. RZQ/4 support is optional for LPDDR3-1333 and LPDDR3-1600 devices. Consult manufacturer specifications for RZQ/4 support for LPDDR3- 1333 and LPDDR3-1600.

MR12:15_(Reserved) (MA<7:0> = 0CH-0FH):

MR16_PASR_Bank Mask (MA<7:0> = 010H):

OP7	OP6	OP5	OP4	OP3	OP2	OP1	OP0
Bank Mask							

Bank <7:0> Mask	Write-only	OP<7:0>	0_B : refresh enable to the bank (= unmasked, default) 1_B : refresh blocked (= masked)	1
-----------------	------------	---------	--	---

OP	Bank Mask	8-Bank SDRAM
0	XXXXXXXX1	Bank 0
1	XXXXXXXX1X	Bank 1
2	XXXXX1XX	Bank 2
3	XXXX1XXX	Bank 3
4	XXX1XXXX	Bank 4
5	XX1XXXXX	Bank 5
6	X1XXXXXX	Bank 6
7	1XXXXXXXX	Bank 7

MR17_PASR_Segment Mask (MA<7:0> = 011_H):

OP7	OP6	OP5	OP4	OP3	OP2	OP1	OP0
Segment Mask							

Segment <7:0> Mask	Write-only	OP<7:0>	0_B : refresh enable to the segment (=unmasked, default) 1_B : refresh blocked (=masked)
-----------------------	------------	---------	---

Segment	OP	Segment Mask	1Gb
			R12:10
0	0	XXXXXXXX1	000 _B
1	1	XXXXXXXX1X	001 _B
2	2	XXXXX1XX	010 _B
3	3	XXXX1XXX	011 _B
4	4	XXX1XXXX	100 _B
5	5	XX1XXXXX	101 _B
6	6	X1XXXXXX	110 _B
7	7	1XXXXXXX	111 _B

Note:

- This table indicates the range of row addresses in each masked segment. X is do not care for a particular segment.

MR18-31_Reserved (MA<7:0> = 012_H - 01F_H):

MR32_DQ Calibration Pattern A (MA<7:0> = 20_H):

Reads to MR32 return DQ Calibration Pattern "A". See "DQ Calibration".

MR33:39_(Do Not Use) (MA<7:0> = 21_H-27_H):

MR40_DQ Calibration Pattern B (MA<7:0> = 28_H):

Reads to MR40 return DQ Calibration Pattern "B". See "DQ Calibration".

MR41_CA Training_1 (MA<7:0> = 29_H):

Writes to MR41 enables CA Training. See Mode Register Write - CA Training Mode.

MR42_CA Training_2 (MA<7:0> = 2A_H):

Writes to MR42 exits CA Training. See Mode Register Write - CA Training Mode.

MR43:47_(Do Not Use) (MA<7:0> = 2B_H-2F_H):

MR48_CA Training_3 (MA<7:0> = 30_H):

Writes to MR48 enables CA Training. See Mode Register Write - CA Training Mode.

MR49:62_(Reserved) (MA<7:0>=31_H-3E_H):

MR63_Reset (MA<7:0> = 3F_H): MRW only

OP7	OP6	OP5	OP4	OP3	OP2	OP1	OP0
X or 0xFC ¹							

Note: 1. For additional information on MRW RESET see "Mode Register Write".

MR64:255_(Reserved) (MA<7:0> = 40_H-FF_H):

LPDDR3 Command Definitions and Timing Diagrams

Activate Command

The ACTIVATE command is issued by holding CS_n LOW, CA0 LOW, and CA1 HIGH at the rising edge of the clock. The bank addresses BA0 to BA2 are used to select the desired bank. Row addresses are used to determine which row to activate in the selected bank. The ACTIVATE command must be applied before any READ or WRITE operation can be executed. The device can accept a READ or WRITE command at t_{RCD} after the ACTIVATE command is issued. After a bank has been activated it must be precharged before another ACTIVATE command can be applied to the same bank. The bank active and precharge times are defined as t_{TRAS} and t_{TRP}, respectively. The minimum time interval between successive ACTIVATE commands to the same bank is determined by the RAS cycle time of the device (t_{RC}). The minimum time interval between ACTIVATE commands to different banks is t_{RRD} (see Simplified Bus Interface State Diagram figure).

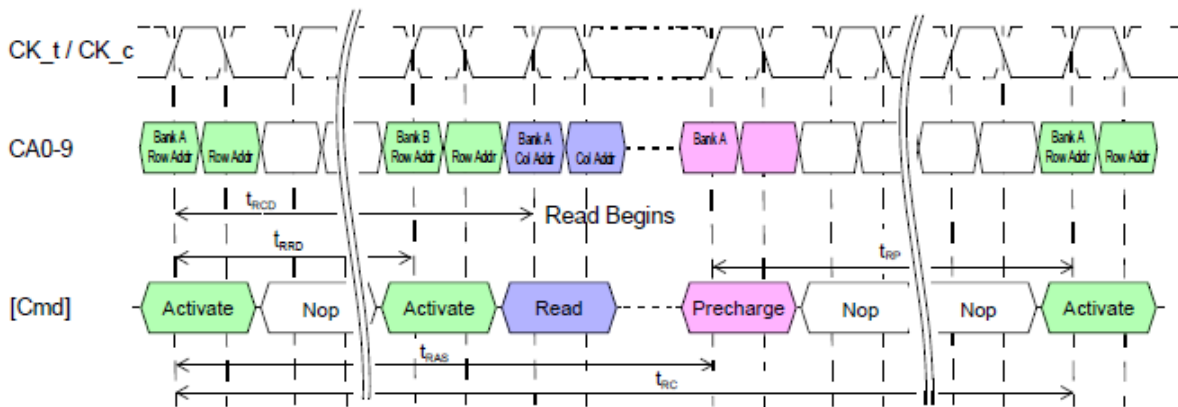

ACTIVATE Command

A PRECHARGE-all command uses t_{RPab} timing, while a single-bank PRECHARGE command uses t_{RPpb} timing. In this figure, t_{TRP} is used to denote either an all-bank PRECHARGE or a single-bank PRECHARGE.

8-Bank Device Operation

Certain restrictions on operation of the 8-bank LPDDR3 devices must be observed. There are two rules: One rule restricts the number of sequential ACTIVATE commands that can be issued; the other provides more time for RAS precharge for a PRECHARGE ALL command. The rules are as follows:

The 8-Bank Device Sequential Bank Activation Restriction: No more than 4 banks may be activated (or refreshed, in the case of REFpb) in a rolling t_{FAW} window. The number of clocks in a t_{FAW} period is dependent upon the clock frequency, which may vary. If the clock frequency is not changed over this period, converting to clocks is done by dividing t_{FAW}[ns] by t_{CK}[ns], and rounding up to the next integer value. As an example of the rolling window, if RU(t_{FAW}/t_{CK}) is 10 clocks, and an ACTIVATE command is issued in clock n, no more than three further ACTIVATE commands can be issued at or between clock n + 1 and n + 9. REFpb also counts as bank activation for purposes of t_{FAW}. If the clock frequency is changed during the t_{FAW} period, the rolling t_{FAW} window may be calculated in clock cycles by adding up the time spent in each clock period. The t_{FAW} requirement is met when the previous n clock cycles exceeds the t_{FAW} time.

The 8-Bank Device Precharge-All Allowance: t_{TRP} for a PRECHARGE ALL command must equal t_{TRPab}, which is greater than t_{TRPpb}.

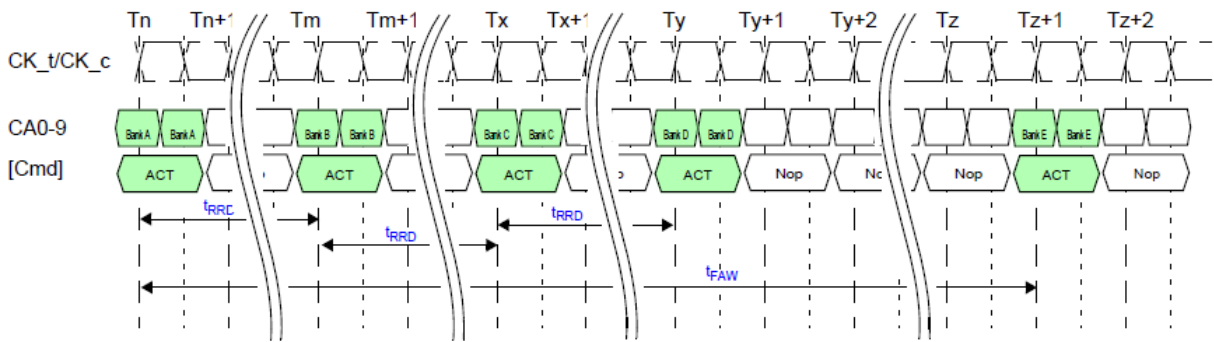

LPDDR3 t_{FAW} Timing

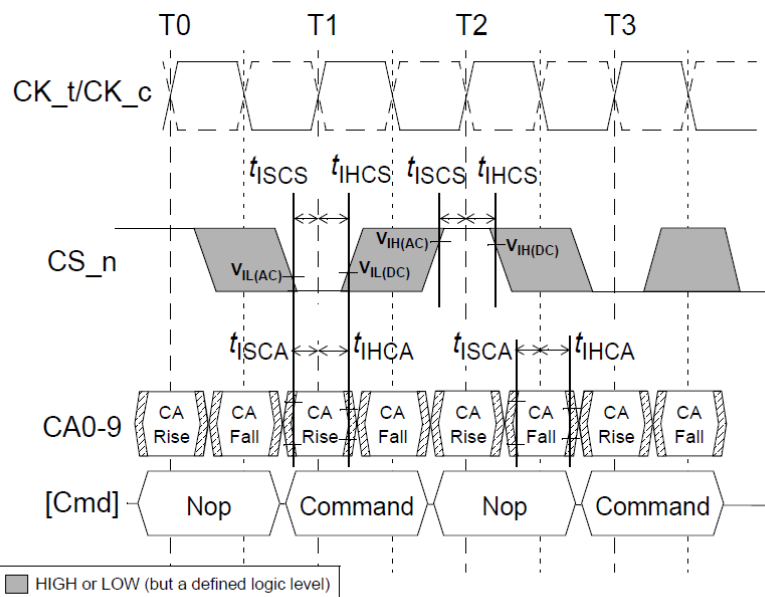

■ HIGH or LOW (but a defined logic level)

NOTE Setup and hold conditions also apply to the CKE pin. See section related to power down for timing diagrams related to the CKE pin.

Command Input Setup and Hold Timing

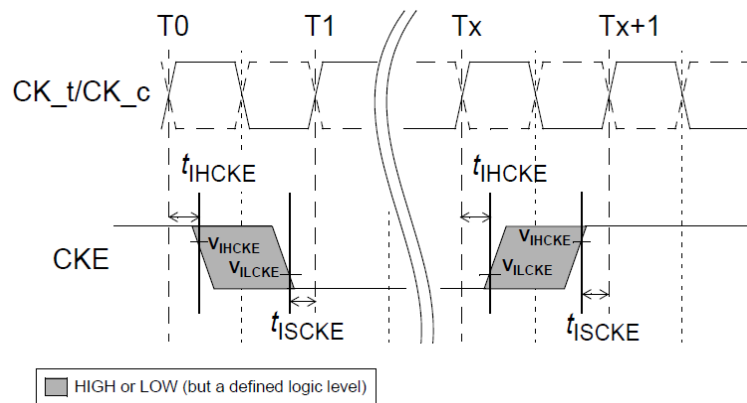

Command Input Setup and Hold Timing

Note:

1. After CKE is registered LOW, CKE signal level shall be maintained below V_{ILCKE} for t_{CKE} specification (LOW pulse width).
2. After CKE is registered HIGH, CKE signal level shall be maintained above V_{IHCKE} for t_{CKE} specification (HIGH pulse width).

Read and Write access modes

After a bank has been activated, a read or write cycle can be executed. This is accomplished by setting CS_n LOW, CA0 HIGH, and CA1 LOW at the rising edge of the clock. CA2 must also be defined at this time to determine whether the access cycle is a read operation (CA2 HIGH) or a write operation (CA2 LOW).

The LPDDR3 SDRAM provides a fast column access operation. A single Read or Write Command will initiate a burst read or write operation on successive clock cycles. Burst interrupts are not allowed.

Burst Read Operation

The burst READ command is initiated with CS_n LOW, CA0 HIGH, CA1 LOW, and CA2 HIGH at the rising edge of the clock. The command address bus inputs CA5r–CA6r and CA1f–CA9f determine the starting column address for the burst. The read latency (RL) is defined from the rising edge of the clock on which the READ command is issued to the rising edge of the clock from which the t_{DQSCK} delay is measured. The first valid data is available $RL \times t_{CK} + t_{DQSCK} + t_{DQSQ}$ after the rising edge of the clock when the READ command is issued. The data strobe output is driven LOW tRPRE before the first valid rising strobe edge. The first bit of the burst is synchronized with the first rising edge of the data strobe. Each subsequent data-out appears on each DQ pin, edge-aligned with the data strobe.

The RL is programmed in the mode registers. Pin timings for the data strobe are measured relative to the crosspoint of DQS_t and its complement, DQS_c.

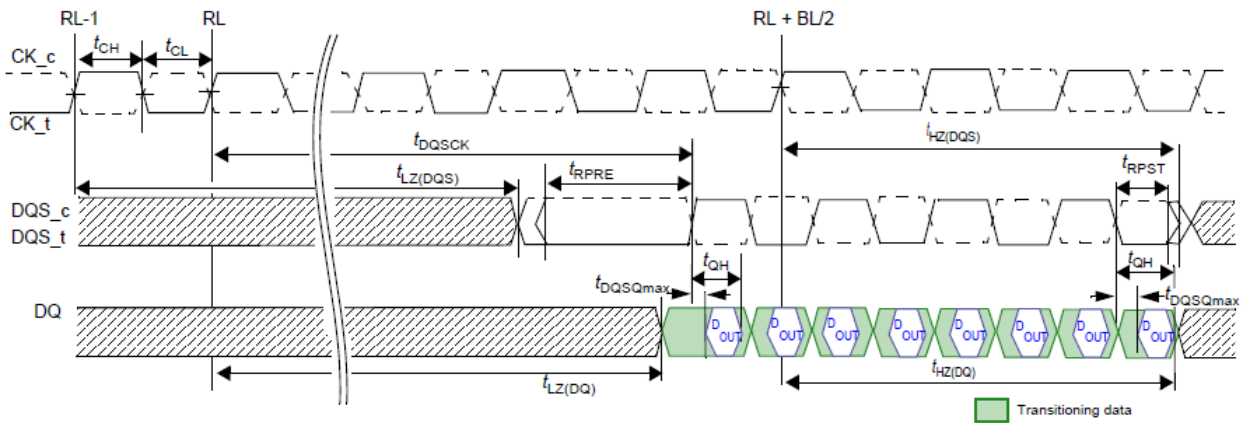

Read Output Timing

Note:

1. t_{DQSCK} can span multiple clock periods.
2. An effective burst length of 8 is shown.

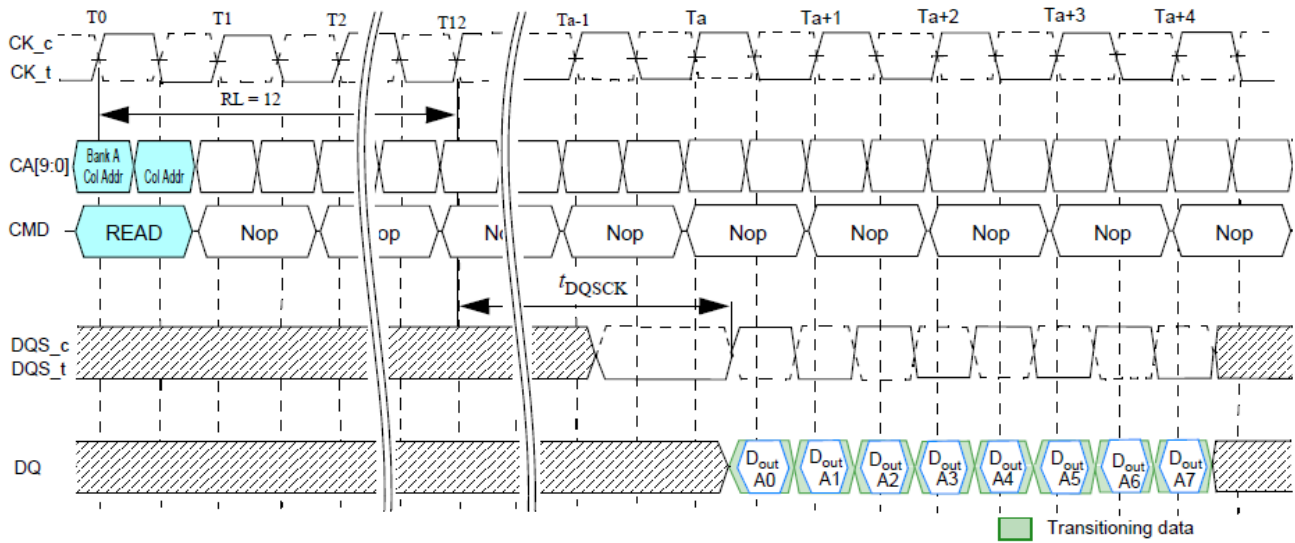

Burst Read: RL = 12, BL = 8, $t_{DQSCk} > t_{ck}$

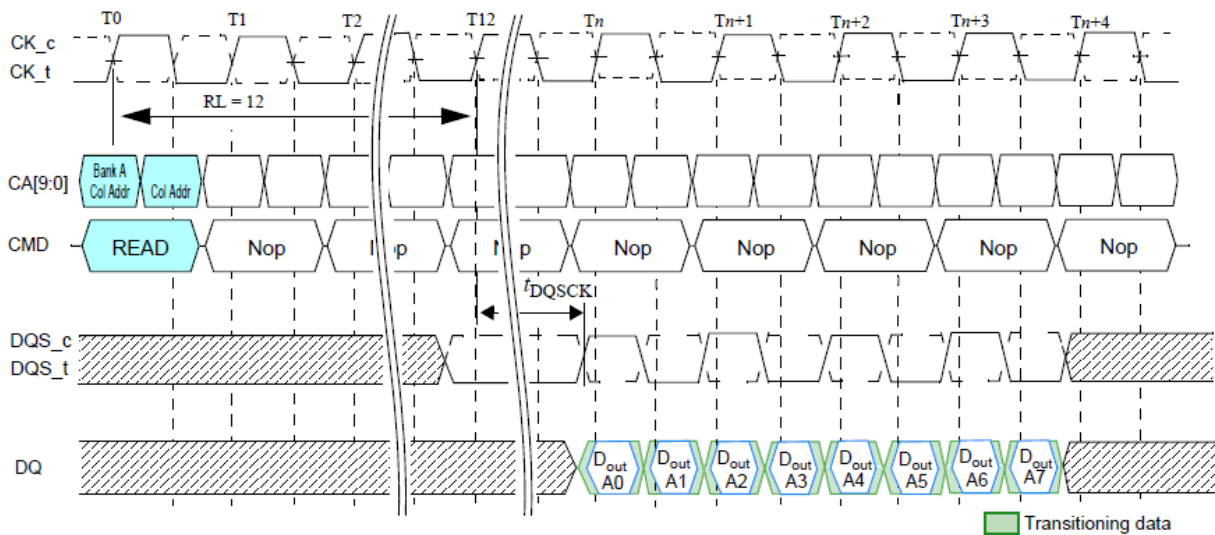

Burst Read: RL = 12, BL = 8, $t_{DQSCk} < t_{ck}$

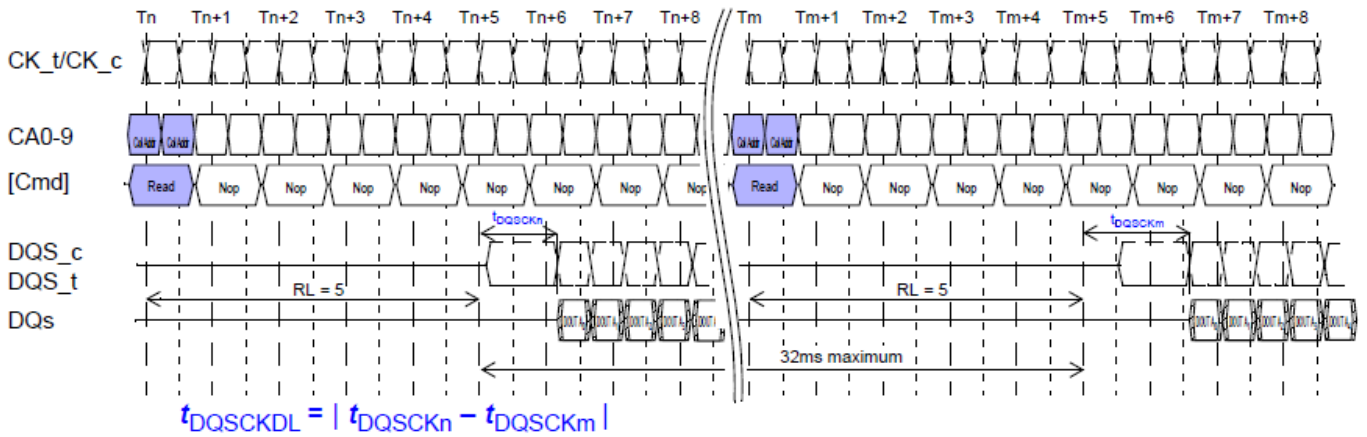

t_{DQCKDL} timing

Note: 1. $t_{DQCKDLmax}$ is defined as the maximum of $ABS(t_{DQCKn} - t_{DQCKm})$ for any $\{t_{DQCKn}, t_{DQCKm}\}$ pair within any 32ms rolling window.

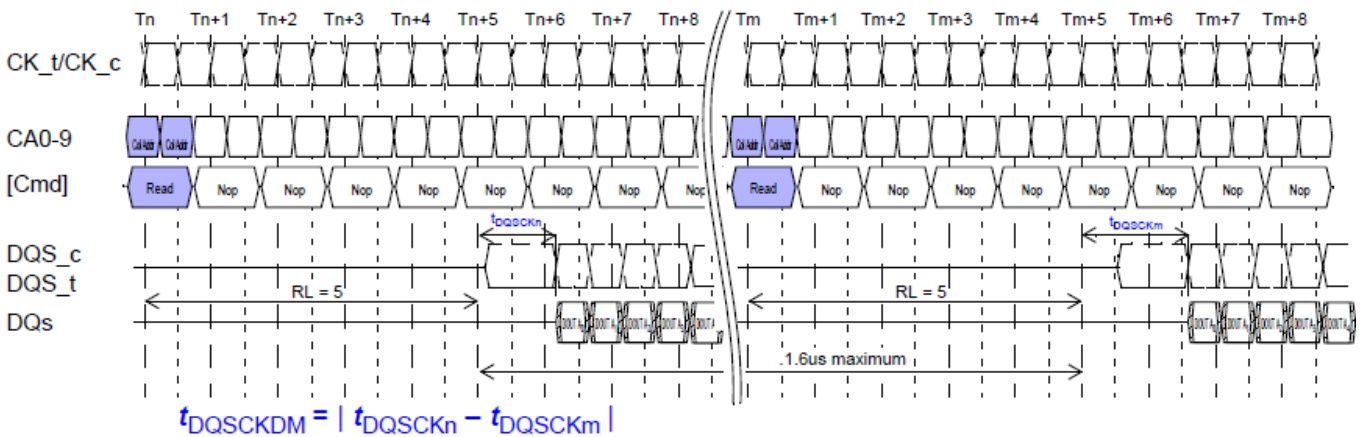

t_{DQCKDM} timing

Note: 1. $t_{DQCKDMmax}$ is defined as the maximum of $ABS(t_{DQCKn} - t_{DQCKm})$ for any $\{t_{DQCKn}, t_{DQCKm}\}$ pair within any 1.6us rolling window.

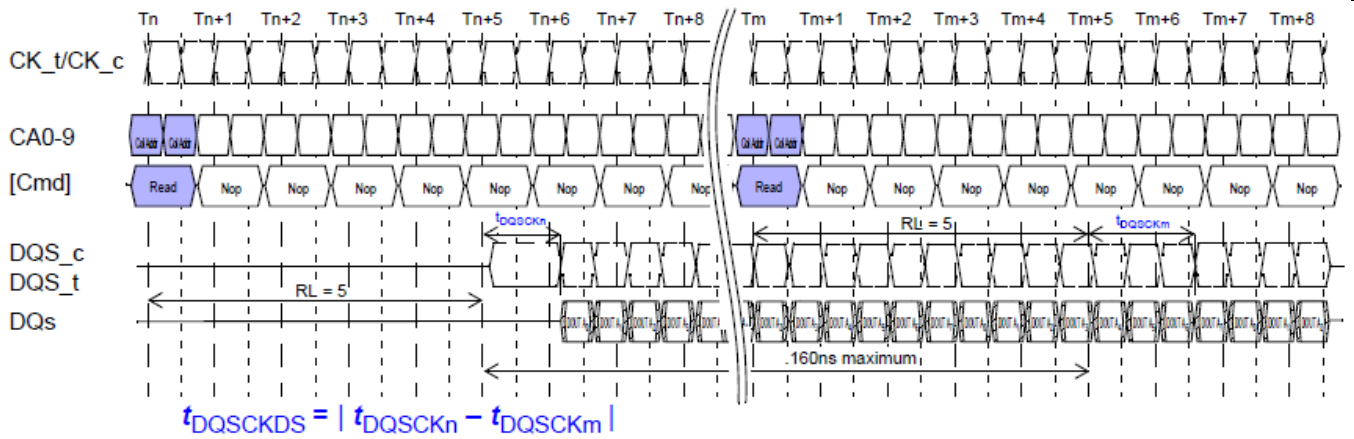

$t_{DQsckds}$ timing

Note: 1. $t_{DQsckdsmax}$ is defined as the maximum of $ABS(t_{DQsckn} - t_{DQsckm})$ for any $\{t_{DQsckn}, t_{DQsckm}\}$ pair for reads within a consecutive burst within any 160ns rolling window.

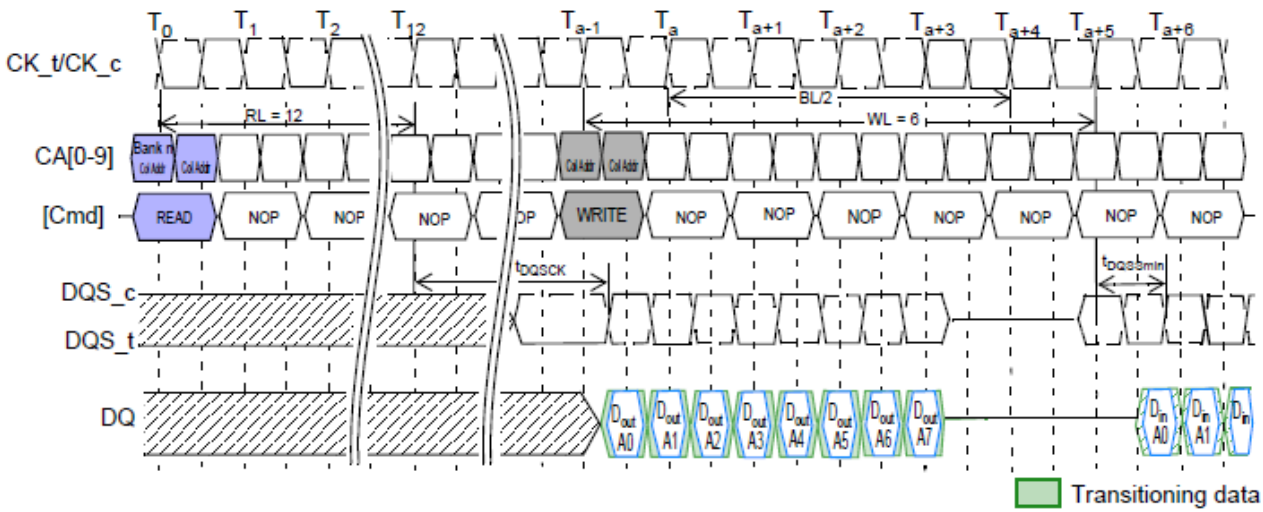

Burst Read Followed By Burst Write

The minimum time from the burst READ command to the burst WRITE command is defined by the read latency (RL) and the burst length (BL). Minimum READ-to-WRITE latency is $RL + RU(t_{DQSCk(MAX)}/t_{CK}) + BL/2 + 1 - WL$ clock cycles.

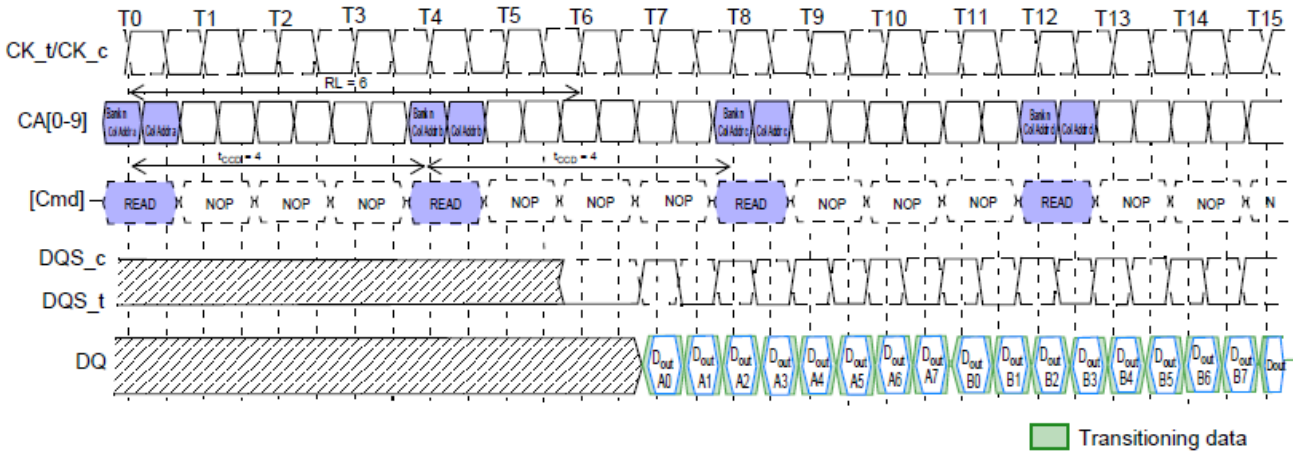

Seamless Burst Read

The seamless burst READ operation is supported by enabling a READ command at every fourth clock cycle for BL = 8 operation. This operation is supported as long as the banks are activated, whether the accesses read the same or different banks.

Burst Write Operation

The burst WRITE command is initiated with CS_n LOW, CA0 HIGH, CA1 LOW, and CA2 LOW at the rising edge of the clock. The command address bus inputs, CA5r–CA6r and CA1f–CA9f, determine the starting column address for the burst. Write latency (WL) is defined from the rising edge of the clock on which the WRITE command is issued to the rising edge of the clock from which the t_{DQSS} delay is measured. The first valid data must be driven $WL \times t_{CK} + t_{DQSS}$ from the rising edge of the clock from which the WRITE command is issued. The data strobe signal (DQS) must be driven for time t_{WPRE} as shown in Method for Calculating t_{WPRE} Transitions and Endpoints figure prior to data input. The burst cycle data bits must be applied to the DQ pins t_{DS} prior to the associated edge of the DQS and held valid until t_{DH} after that edge.

Burst data is sampled on successive edges of the DQS until the 8-bit burst length is completed. After a burst WRITE operation, t_{WR} must be satisfied before a PRECHARGE command to the same bank can be issued. Pin input timings are measured relative to the crosspoint of DQS_t and its complement, DQS_c.

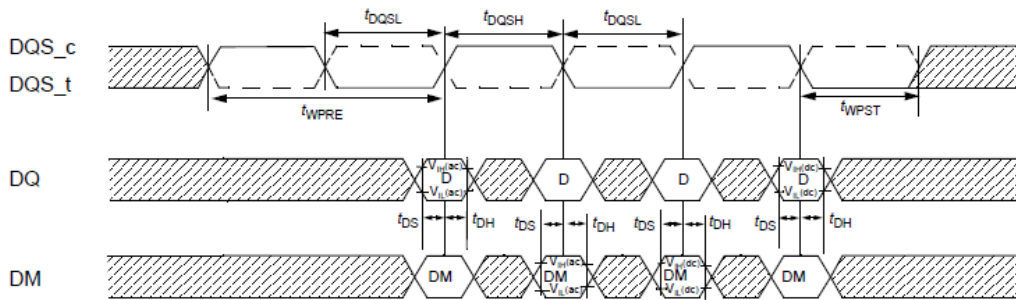

Data input (write) timing

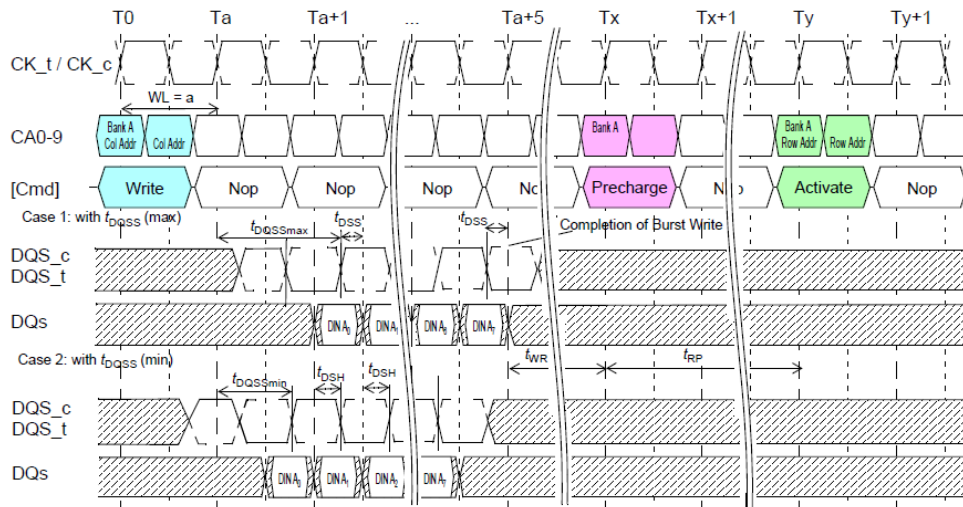

Burst Write

t_{WPRE} Calculation

The method for calculating t_{WPRE} is shown in the following figure:

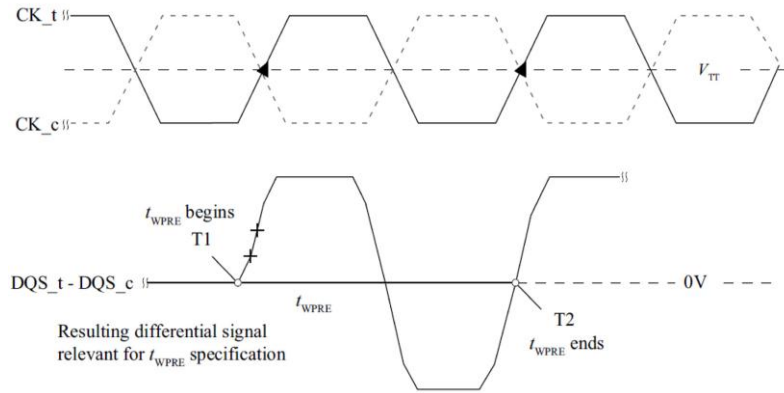

Method for Calculating t_{WPRE} Transitions and Endpoints

t_{WPST} Calculation

The method for calculating t_{WPST} is shown in the following figure:

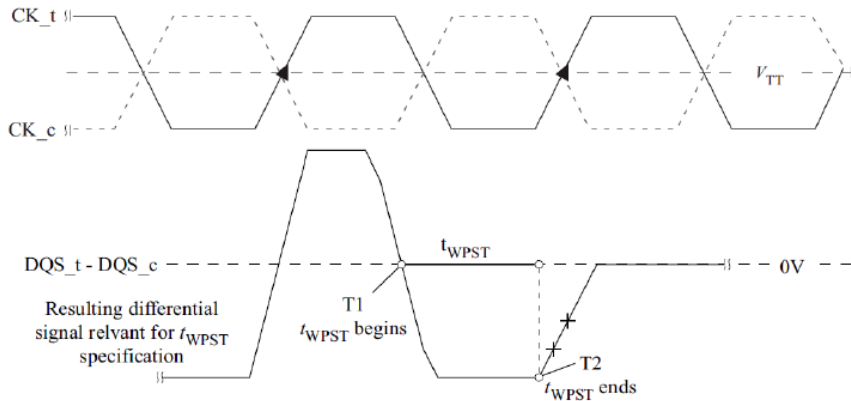

Method for Calculating t_{WPST} Transitions and Endpoints

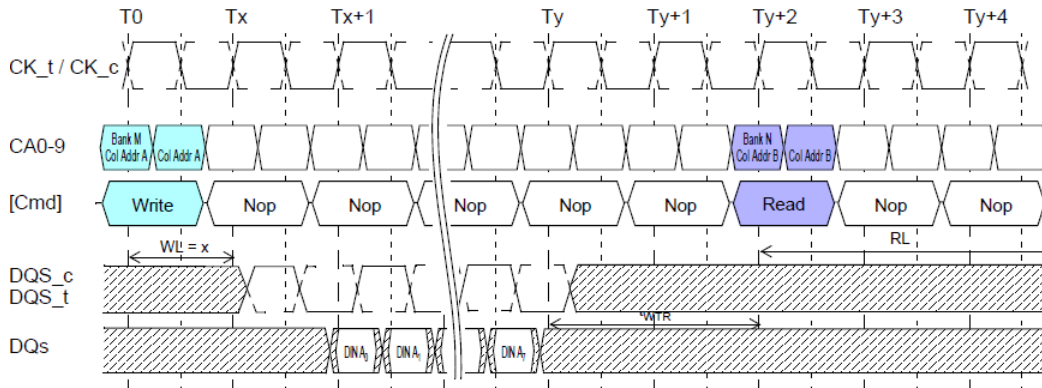

Burst Write Followed By Burst Read

Note:

1. The minimum number of clock cycles from the burst write command to the burst read command for any bank is $[WL + 1 + BL/2 + RU(t_{WTR}/t_{CK})]$.
2. t_{WTR} starts at the rising edge of the clock after the last valid input datum.

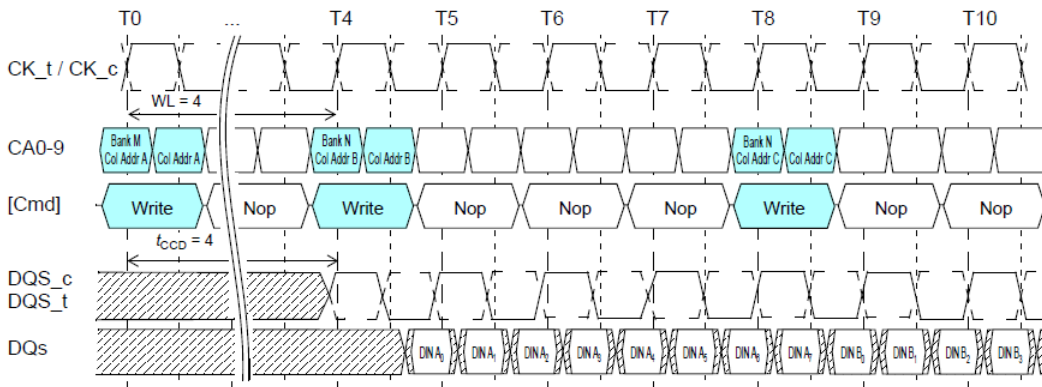

Seamless burst write: $WL = 4, t_{CCD} = 4$

Note: 1. The seamless burst write operation is supported by enabling a write command every four clocks for $BL = 8$ operation. This operation is allowed for any activated bank.

Write Data Mask

On LPDDR3 devices, one write data mask (DM) pin for each data byte (DQ) is supported, consistent with the implementation on LPDDR2 SDRAM. Each DM can mask its respective DQ for any given cycle of the burst. Data mask timings match data bit timing, but are inputs only. Internal data-mask loading is identical to data-bit loading to ensure matched system timing. For data mask timing, see Simplified Bus Interface State Diagram figure.

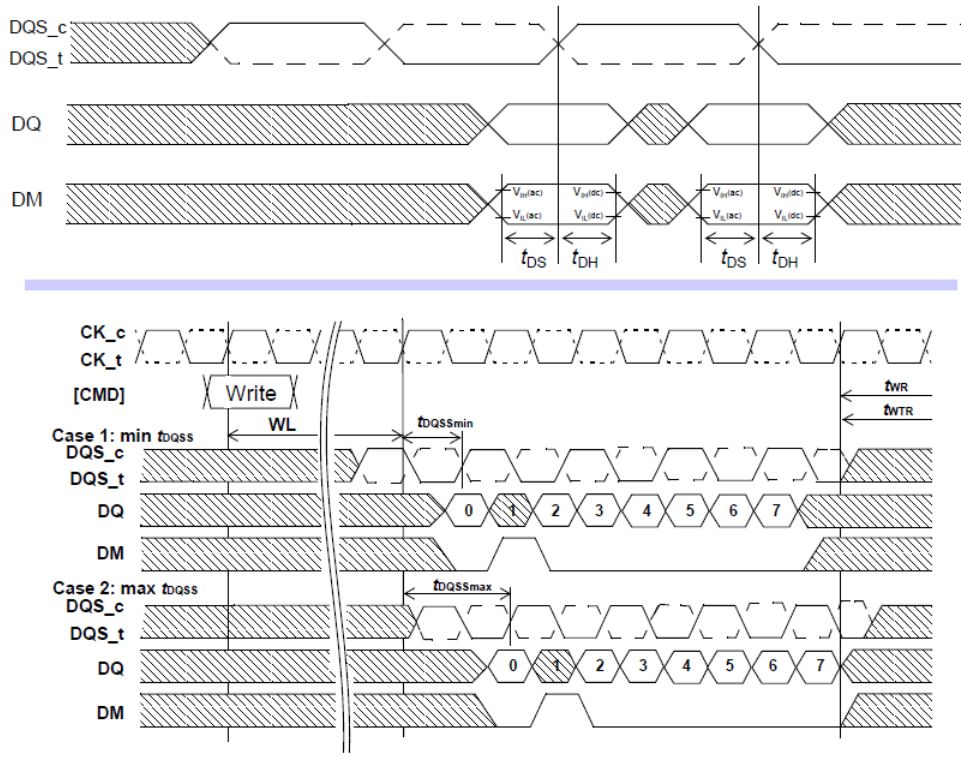

Data Mask Timing

Note: 1. For the data mask function, BL = 8 is shown; the second data bit is masked.

Precharge Operation

The PRECHARGE command is used to precharge or close a bank that has been activated. The PRECHARGE command is initiated with CS_n LOW, CA0 HIGH, CA1 HIGH, CA2 LOW, and CA3 HIGH at the rising edge of the clock. The PRECHARGE command can be used to precharge each bank independently or all banks simultaneously.

The AB flag and the bank address bits BA0, BA1, and BA2 are used to determine which bank(s) to precharge. The precharged bank(s) will be available for subsequent row access t_{RPab} after an all-bank PRECHARGE command is issued, or t_{RPpb} after a single-bank PRECHARGE command is issued.

To ensure that LPDDR3 devices can meet the instantaneous current demand required to operate, the row-precharge time for an all-bank PRECHARGE (t_{RPab}) will be longer than the row PRECHARGE time for a single-bank PRECHARGE (t_{RPpb}). Activate to Precharge timing is shown in ACTIVATE Command figure.

Bank selection for Precharge by address bits

AB (CA4r)	BA2 (CA9r)	BA1 (CA8r)	BA0 (CA7r)	Precharged Bank(s)
0	0	0	0	Bank 0 only
0	0	0	1	Bank 1 only
0	0	1	0	Bank 2 only
0	0	1	1	Bank 3 only
0	1	0	0	Bank 4 only
0	1	0	1	Bank 5 only
0	1	1	0	Bank 6 only
0	1	1	1	Bank 7 only
1	DON'T CARE	DON'T CARE	DON'T CARE	All Banks

Burst Read operation followed by Precharge

For the earliest possible precharge, the PRECHARGE command can be issued BL/2 clock cycles after a READ command. A new bank ACTIVATE command can be issued to the same bank after the row PRECHARGE time (t_{RP}) has elapsed. A PRECHARGE command cannot be issued until after t_{RAS} is satisfied. The minimum READ-to-PRECHARGE time must also satisfy a minimum analog time from the rising clock edge that initiates the last 8-bit prefetch of a READ command. t_{RTP} begins BL/2 - 4 clock cycles after the READ command. For LPDDR3 READ-to-PRECHARGE timings see Precharge & Auto Precharge clarification table.

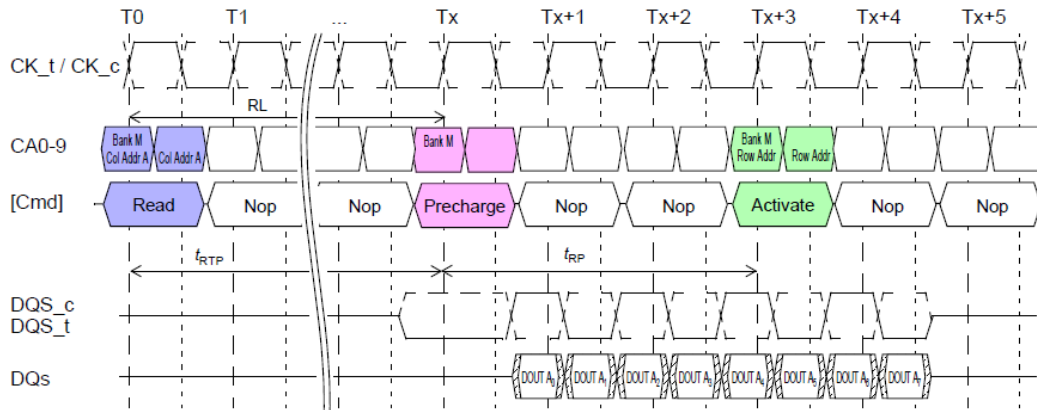

Burst Read Followed by Precharge

Burst Write followed by Precharge

For WRITE cycles, a WRITE recovery time (t_{WR}) must be provided before a PRECHARGE command can be issued. This delay is referenced from the last valid burst input data to the completion of the burst WRITE. A PRECHARGE command must not be issued prior to the t_{WR} delay. For LPDDR3 Write-to-Precharge timings see Precharge & Auto Precharge clarification table.

LPDDR3 devices write data to the array in prefetch multiples(prefetch = 8). An internal WRITE operation can only begin after a prefetch group has been completely latched, so t_{WR} starts at prefetch boundaries. The minimum WRITE-to-PRECHARGE time for commands to the same bank is $WL + BL/2 + 1 + RU(t_{WR}/t_{CK})$ clock cycles.

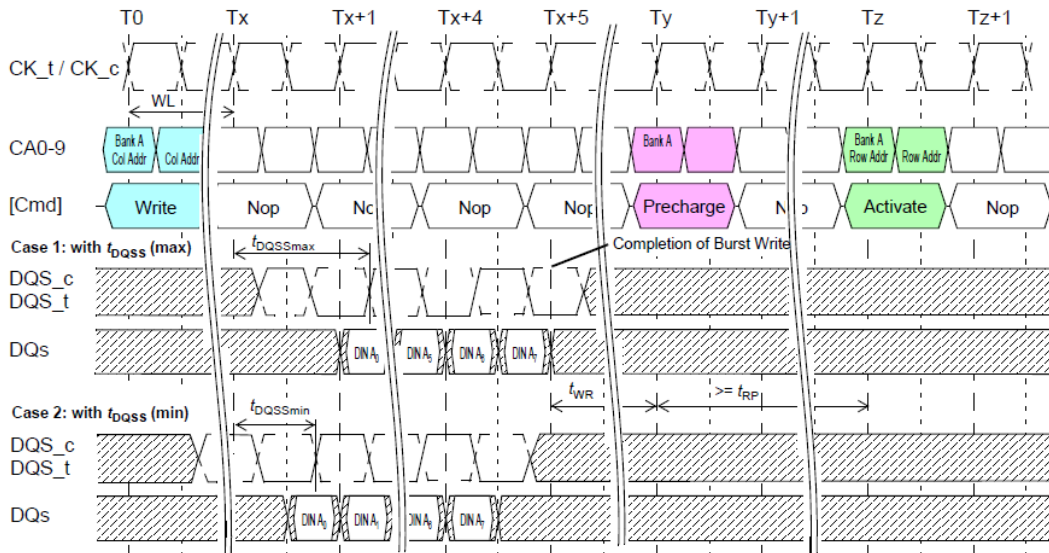

Burst Write Followed by Precharge

Auto Precharge operation

Before a new row can be opened in an active bank, the active bank must be precharged using either the PRECHARGE command or the auto precharge function. When a READ or a WRITE command is issued to the device, the AP bit (CA0f) can be set to enable the active bank to automatically begin precharge at the earliest possible moment during the burst READ or WRITE cycle.

If AP is LOW when the READ or WRITE command is issued, then normal READ or WRITE burst operation is executed and the bank remains active at the completion of the burst.

If AP is HIGH when the READ or WRITE command is issued, the auto precharge function is engaged. This feature enables the PRECHARGE operation to be partially or completely hidden during burst READ cycles (dependent upon READ or WRITE latency) thus improving system performance for random data access.

Burst Read with Auto-Precharge

If AP (CA0f) is HIGH when a READ command is issued, the READ with auto-precharge function is engaged.

LPDDR3 devices start an auto-precharge operation on the rising edge of the clock BL/2 or BL/2 - 4 + RU(t_{RTP}/t_{CK}) clock cycles later than the READ with auto precharge command, whichever is greater. For LPDDR3 auto-precharge calculations see Precharge & Auto Precharge clarification table. Following an auto-precharge operation, an ACTIVATE command can be issued to the same bank if the following two conditions are satisfied simultaneously:

- a) The RAS precharge time (t_{RP}) has been satisfied from the clock at which the auto- precharge begins.
- b) The RAS cycle time (t_{RC}) from the previous bank activation has been satisfied.

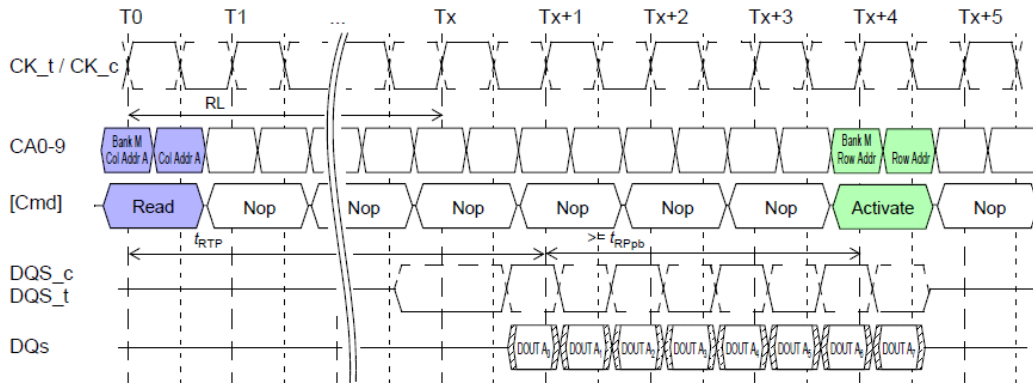

Burst Read with Auto Precharge

Burst write with Auto-Precharge

If AP (CA0f) is HIGH when a WRITE command is issued, the WRITE with auto precharge function is engaged. The device starts an auto precharge on the rising edge t_{WR} cycles after the completion of the burst WRITE.

Following a WRITE with auto precharge, an ACTIVATE command can be issued to the same bank if the following two conditions are met:

The RAS precharge time (t_{RP}) has been satisfied from the clock at which the auto-precharge begins.

The RAS cycle time (t_{RC}) from the previous bank activation has been satisfied.

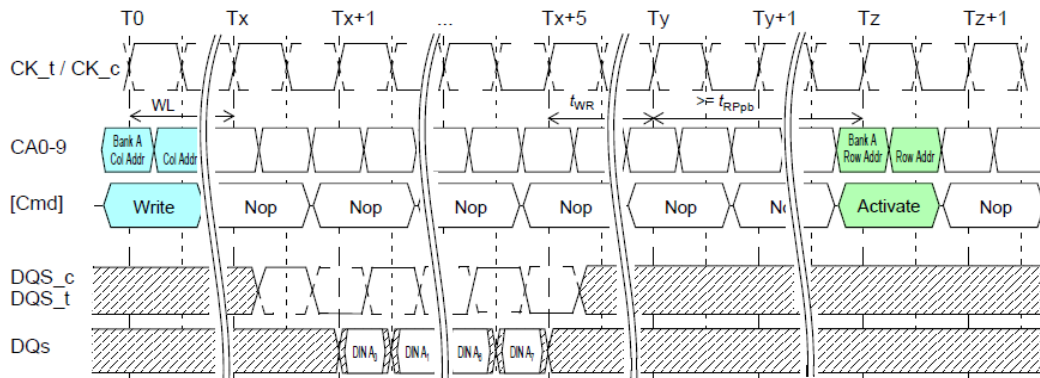

Burst Write with Auto Precharge

Precharge & Auto Precharge clarification

From Command	To Command	Minimum Delay between "From Command" to "To Command"	Unit	Notes
Read	Precharge (to same Bank as Read)	$BL/2 + \max(4, RU(t_{RTP}/t_{CK})) - 4$	clks	1
	Precharge All	$BL/2 + \max(4, RU(t_{RTP}/t_{CK})) - 4$	clks	1
Read w/AP	Precharge (to same Bank as Read w/AP)	$BL/2 + \max(4, RU(t_{RTP}/t_{CK})) - 4$	clks	1,2
	Precharge All	$BL/2 + \max(4, RU(t_{RTP}/t_{CK})) - 4$	clks	1
	Activate (to same Bank as Read w/AP)	$BL/2 + \max(4, RU(t_{RTP}/t_{CK})) - 4 + RU(t_{RPPb}/t_{CK})$	clks	1
	Write or Write w/AP (same bank)	Illegal	clks	3
	Write or Write w/AP (different bank)	$RL + BL/2 + RU(t_{DQSKmax}/t_{CK}) - WL + 1$	clks	3
	Read or Read w/AP (same bank)	Illegal	clks	3
	Read or Read w/AP (different bank)	$BL/2$	clks	3
Write	Precharge (to same Bank as Write)	$WL + BL/2 + RU(t_{WR}/t_{CK}) + 1$	clks	1
	Precharge All	$WL + BL/2 + RU(t_{WR}/t_{CK}) + 1$	clks	1
Write w/AP	Precharge (to same Bank as Write w/AP)	$WL + BL/2 + RU(t_{WR}/t_{CK}) + 1$	clks	1
	Precharge All	$WL + BL/2 + RU(t_{WR}/t_{CK}) + 1$	clks	1
	Activate (to same Bank as Write w/AP)	$WL + BL/2 + RU(t_{WR}/t_{CK}) + 1 + RU(t_{RPPb}/t_{CK})$	clks	1
	Write or Write w/AP (same bank)	Illegal	clks	3
	Write or Write w/AP (different bank)	$BL/2$	clks	3
	Read or Read w/AP (same bank)	Illegal	clks	3
	Read or Read w/AP (different bank)	$WL + BL/2 + RU(t_{WTR}/t_{CK}) + 1$	clks	3
Precharge	Precharge (to same Bank as Precharge)	1	clks	1
	Precharge All	1	clks	1
Precharge All	Precharge	1	clks	1
	Precharge All	1	clks	1

Note:

- For a given bank, the precharge period should be counted from the latest precharge command, either one bank precharge or precharge all, issued to that bank. The precharge period is satisfied after tRP depending on the latest precharge command issued to that bank.
- Any command issued during the minimum delay time as specified in Precharge & Auto Precharge clarification table is illegal.
- After Read with AP, seamless read operations to different banks are supported. After Write with AP, seamless write operations to different banks are supported. Read and Write operations may not be truncated or interrupted.

Refresh command

The REFRESH command is initiated with CS_n LOW, CA0 LOW, CA1 LOW, and CA2 HIGH at the rising edge of the clock. Per-bank REFRESH is initiated with CA3 LOW at the rising edge of the clock. All-bank REFRESH is initiated with CA3 HIGH at the rising edge of the clock.

A per-bank REFRESH command (REFpb) performs a per-bank REFRESH operation to the bank scheduled by the bank counter in the memory device. The bank sequence for per-bank REFRESH is fixed to be a sequential roundrobin: 0-1-2-3-4-5-6-7-0-1-.... The bank count is synchronized between the controller and the SDRAM by resetting the bank count to zero. Synchronization can occur upon issuing a RESET signal or at every exit from self refresh.

Bank addressing for the per-bank REFRESH count is the same as established for the single-bank PRECHARGE command. A bank must be idle before it can be refreshed. The controller must track the bank being refreshed by the per-bank REFRESH command.

The REFpb command must not be issued to the device until the following conditions are met:

- t_{RFCab} has been satisfied after the prior REFab command
- t_{RFCpb} has been satisfied after the prior REFpb command
- t_{RP} has been satisfied after the prior PRECHARGE command to that bank
- t_{RRD} has been satisfied after the prior ACTIVATE command (if applicable, for example after activating a row in a different bank than the one affected by the REFpb command).

The target bank is inaccessible during per-bank REFRESH cycle time (t_{RFCpb}), however, other banks within the device are accessible and can be addressed during the cycle. During the REFpb operation, any of the banks other than the one being refreshed can be maintained in an active state or accessed by a READ or a WRITE command. When the per-bank REFRESH cycle has completed, the affected bank will be in the idle state.

After issuing REFpb, these conditions must be met:

- t_{RFCpb} must be satisfied before issuing a REFab command
- t_{RFCpb} must be satisfied before issuing an ACTIVATE command to the same bank
- t_{RRD} must be satisfied before issuing an ACTIVATE command to a different bank
- t_{RFCpb} must be satisfied before issuing another REFpb command.

An all-bank REFRESH command (REFab) issues a REFRESH command to all banks. All banks must be idle when REFab is issued (for instance, by issuing a PRECHARGE-all command prior to issuing an all-bank REFRESH command). REFab also synchronizes the bank count between the controller and the SDRAM to zero. The REFab command must not be issued to the device until the following conditions have been met:

- t_{RFCab} has been satisfied following the prior REFab command
- t_{RFCpb} has been satisfied following the prior REFpb command
- t_{RP} has been satisfied following the prior PRECHARGE commands.

When an all-bank refresh cycle has completed, all banks will be idle. After issuing REFab:

- t_{RFCab} latency must be satisfied before issuing an ACTIVATE command
- t_{RFCab} latency must be satisfied before issuing a REFab or REFpb command.

REFRESH Command Scheduling Separation Requirements

Symbol	Minimum Delay From...	To...	Notes
t_{RFCab}	REFab	REFab	
		ACTIVATE command to any bank	
		REFpb	
t_{RFCpb}	REFpb	REFab	
		ACTIVATE command to same bank as REFpb	
		REFpb	
t_{RRD}	REFpb	ACTIVATE command to a different bank than REFpb	1
	ACTIVATE	REFpb	
		ACTIVATE command to a different bank than the prior ACTIVATE command	

Note: 1. A bank must be in the idle state before it is refreshed, so following an ACTIVATE command REFab is prohibited; REFpb is supported only if it affects a bank that is in the idle state.

In general, an all bank refresh command needs to be issued to the LPDDR3 SDRAM regularly every t_{REFI} (or more precisely $t_{REFIM} = t_{REFI} \times RM$, see MR4 setting) interval. To allow for improved efficiency in scheduling and switching between tasks, some flexibility in the absolute refresh interval is provided for postponing and pulling-in refresh command. A maximum of 8 Refresh commands can be postponed during operation of the LPDDR3 SDRAM, meaning that at no point in time more than a total of 8 Refresh commands are allowed to be postponed. In case that 8 Refresh commands are postponed in a row, the resulting maximum interval between the surrounding Refresh commands is limited to $9 \times t_{REFI}$ ($9 \times t_{REFIM} = 9 \times RM \times t_{REFI}$) (see Simplified Bus Interface State Diagram figure). A maximum of 8 additional Refresh commands can be issued in advance ("pulled in"), with each one reducing the number of regular Refresh commands required later by one. Note that pulling in more than 8, depending on Refresh mode, Refresh commands in advance does not further reduce the number of regular Refresh commands required later, so that the resulting maximum interval between two surrounding Refresh commands is limited to $9 \times t_{REFI}$ ($9 \times t_{REFIM} = 9 \times RM \times t_{REFI}$). At any given time, a maximum of 16 REF commands can be issued within $2 \times t_{REFI}$ ($2 \times t_{REFIM} = 2 \times RM \times t_{REFI}$).

And for per bank refresh, a maximum 8×8 per bank refresh commands can be postponed or pulled in for scheduling efficiency. At any given time, a maximum of $2 \times 8 \times 8$ per bank refresh commands can be issued within $2 \times t_{REFI}$ ($2 \times RM \times t_{REFI}$).

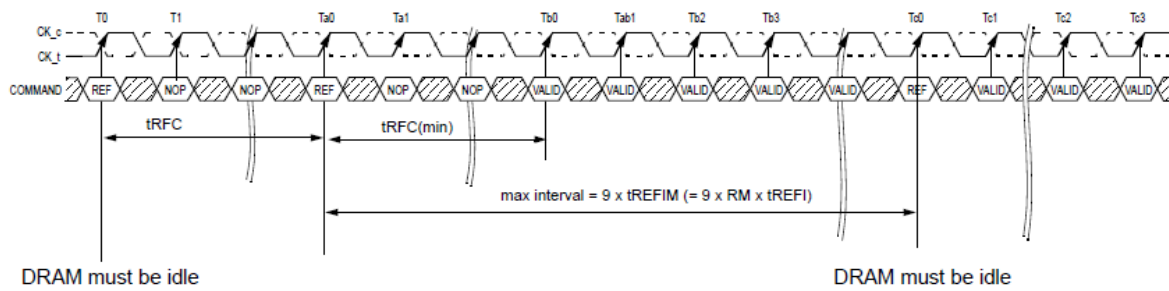

Time Break ☒ Don't Care

Refresh Command Timing

Note:

1. Only NOP commands allowed after Refresh command registered until $t_{RFC(min)}$ expires.
2. Time interval between two Refresh commands may be extended to a maximum of $9 \times t_{REFIM} (= 9 \times RM \times t_{REFI})$.

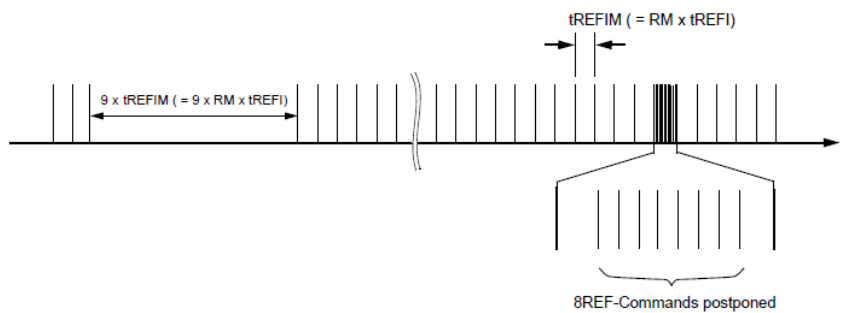

Postponing Refresh Commands

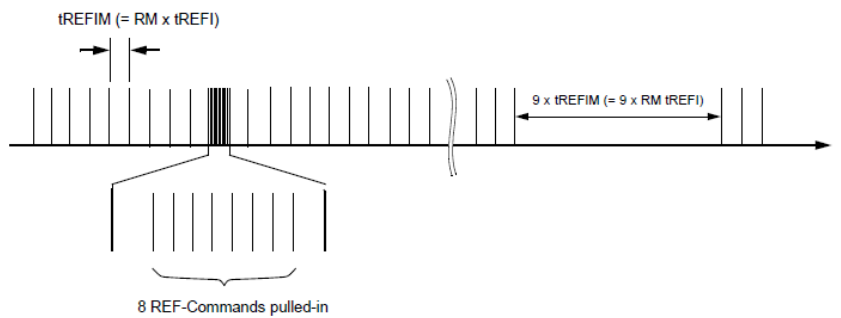

Pulling-in Refresh Commands

Refresh Requirements

a) Minimum number of REFRESH commands

LPDDR3 requires a minimum number, R, of REFRESH (REFab) commands within any rolling refresh window ($t_{REFW} = 32 \text{ ms @ MR4[2:0] = 011}$ or $T_C @ 85^\circ\text{C}$). Based on the settings in MR4 a refresh multiplier RM larger or smaller than 1 may apply. The refresh window then becomes $t_{REFWM} = RM \times t_{REFW}$ and the refresh interval becomes $t_{REFIM} = RM \times t_{REFI}$; refer to MR4 definition for details.

When using per-bank REFRESH, a REFab command can be replaced by a full cycle of eight REFpb commands.

b) REFRESH Requirements and SELF REFRESH

Self refresh mode may be entered with a maximum of eight refresh commands being postponed. After exiting selfrefresh mode with one or more refresh commands postponed, additional refresh commands may be postponed to the extent that the total number of postponed refresh commands (before and after the self refresh) will never exceed eight. During self-refresh mode, the number of postponed or pulled-in REF commands does not change.”

“The use of self refresh mode introduces the possibility that an internally timed refresh event can be missed when CKE is raised for exit from self refresh mode. Upon exit from self refresh, the LPDDR3 SDRAM requires a minimum of one extra refresh command before it is put back into self refresh mode.”

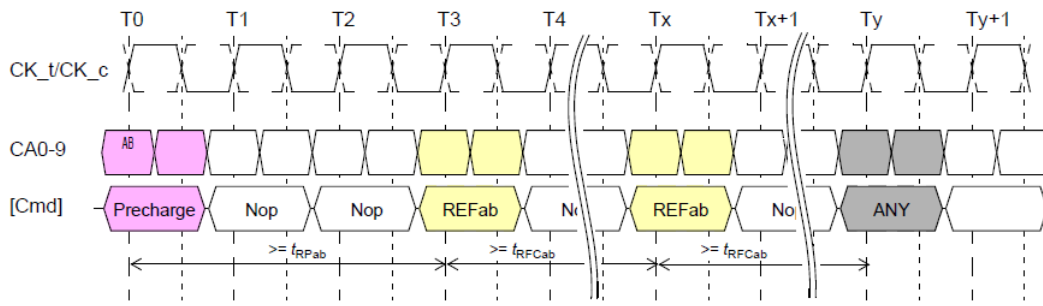

All-Bank REFRESH Operation

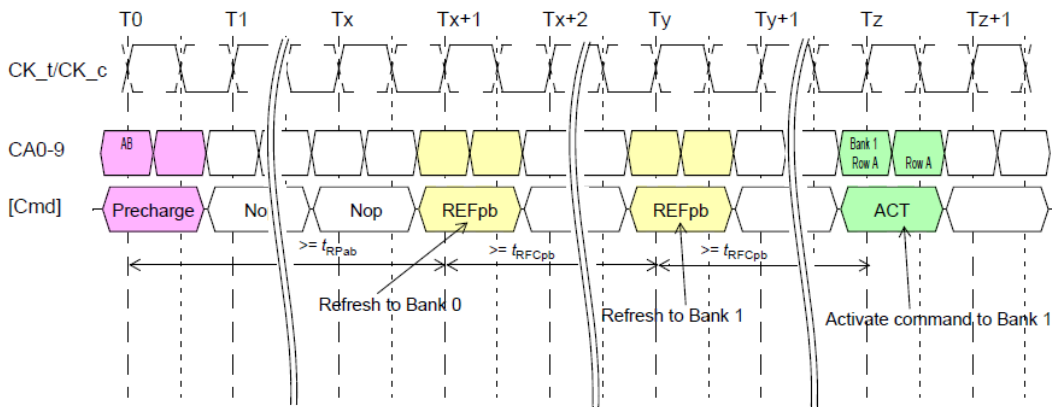

Per-Bank REFRESH Operation

Note:

1. In the beginning of this example, the REFpb bank is pointing to bank 0.
2. Operations to banks other than the bank being refreshed are supported during the t_{RFCpb} period.

Self Refresh operation

The Self Refresh command can be used to retain data in the LPDDR3 SDRAM, even if the rest of the system is powered down. When in the Self Refresh mode, the SDRAM retains data without external clocking. The device has a built-in timer to accommodate Self Refresh operation. The Self Refresh Command is defined by having CKE LOW, CS_n LOW, CA0 LOW, CA1 LOW, and CA2 HIGH at the rising edge of the clock. CKE must be HIGH during the previous clock cycle. CKE must not go LOW while MRR, MRW, READ, or WRITE operations are in progress. To ensure that there is enough time to account for internal delay on the CKE signal path, two NOP commands are required after CKE is driven LOW, this timing period is defined as t_{CPDED} . CKE LOW will result in deactivation of input receivers after t_{CPDED} has expired. Once the command is registered, CKE must be held LOW to keep the device in Self Refresh mode.

LPDDR3 SDRAM devices can operate in Self Refresh in both the standard or elevated temperature ranges. LPDDR3 devices will also manage Self Refresh power consumption when the operating temperature changes, lower at low temperatures and higher at high temperatures.

Once the SDRAM has entered Self Refresh mode, all of the external signals except CKE, are “don’t care”. For proper self refresh operation, power supply pins (V_{DD1} , V_{DD2} , and V_{DDCA}) must be at valid levels. V_{DDQ} may be turned off during Self-Refresh. Prior to exiting Self-Refresh, V_{DDQ} must be within specified limits. V_{refDQ} and V_{refCA} may be at any level within minimum and maximum levels (see Absolute Maximum DC Ratings). However prior to exiting Self-Refresh, V_{refDQ} and V_{refCA} must be within specified limits (see Recommended DC Operating Conditions). The SDRAM initiates a minimum of one all-bank refresh command internally within t_{CKESR} period once it enters Self Refresh mode. The clock is internally disabled during Self Refresh Operation to save power. The minimum time that the SDRAM must remain in Self Refresh mode is $t_{CKESR,min}$. The user may change the external clock frequency or halt the external clock t_{CPDED} after Self Refresh entry is registered; however, the clock must be restarted and stable before the device can exit Self Refresh operation.

The procedure for exiting Self Refresh requires a sequence of commands. First, the clock shall be stable and within specified limits for a minimum of 2 t_{CK} prior to the positive clock edge that registers CKE HIGH. Once Self Refresh Exit is registered, a delay of at least t_{XSR} must be satisfied before a valid command can be issued to the device to allow for any internal refresh in progress. CKE must remain HIGH for the entire Self Refresh exit period t_{XSR} for proper operation. NOP commands must be registered on each positive clock edge during the Self Refresh exit interval t_{XSR} . For the description of ODT operation and specifications during self-refresh entry and exit, see section On-Die Termination.

The use of Self Refresh mode introduces the possibility that an internally timed refresh event can be missed when CKE is raised for exit from Self Refresh mode. Upon exit from Self Refresh, it is required that at least one REFRESH command (8 per-bank or 1 all-bank) is issued before entry into a subsequent Self Refresh.

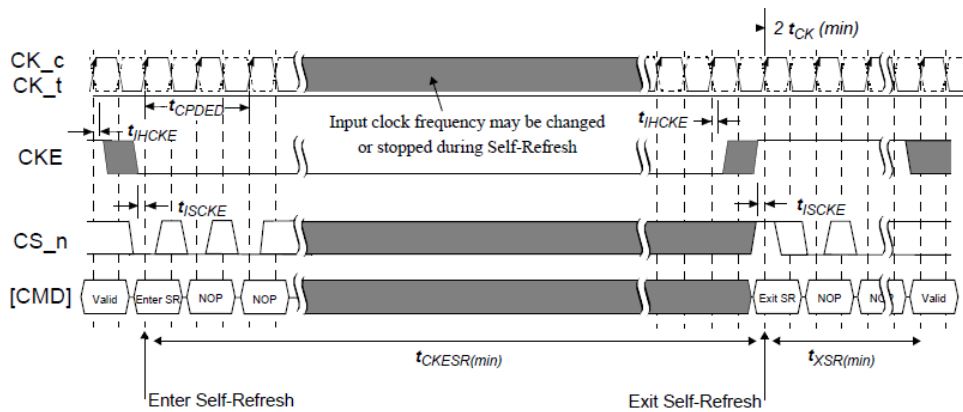

Self-Refresh Operation

Note:

1. Input clock frequency may be changed or can be stopped or floated during self-refresh, provided that upon exiting self-refresh, the clock is stable and within specified limits for a minimum of 2 clocks of stable clock are provided and the clock frequency is between the minimum and maximum frequency for the speed grade in use.
2. Device must be in the “All banks idle” state prior to entering Self Refresh mode.
3. t_{XSR} begins at the rising edge of the clock after CKE is driven HIGH.
4. A valid command may be issued only after t_{XSR} is satisfied. NOPs shall be issued during t_{XSR} .

Partial Array Self-Refresh (PASR)

PASR Bank Masking

The LPDDR3 SDRAM has eight banks (additional banks may be required for higher densities). Each bank of an LPDDR3 SDRAM can be independently configured whether a self refresh operation is taking place. One mode register unit of 8 bits, accessible via MRW command, is assigned to program the bank masking status of each bank up to 8 banks. For bank masking bit assignments, see Mode Register 16 as described. The mask bit to the bank controls a refresh operation of entire memory within the bank. If a bank is masked via MRW, a refresh operation to the entire bank is blocked and data retention by a bank is not guaranteed in self refresh mode. To enable a refresh operation to a bank, a coupled mask bit has to be programmed, "unmasked". When a bank mask bit is unmasked, a refresh to a bank is determined by the programmed status of segment mask bits, which is described in the following chapter.

PASR Segment Masking

A segment masking scheme may be used in lieu of or in combination with the bank masking scheme in LPDDR3 SDRAM. LPDDR3 devices utilize eight segments per bank. For segment masking bit assignments, see Mode Register 17 as described. For those refresh-enabled banks, a refresh operation to the address range which is represented by a segment is blocked when the mask bit to this segment is programmed, "masked". Programming of segment mask bits is similar to the one of bank mask bits. Eight segments are used as listed in Mode Register 17 as described. One mode register unit is used for the programming of segment mask bits up to 8 bits. One more mode register unit may be reserved for future use. Programming of bits in the reserved registers has no effect on the device operation.

Example of Bank and Segment Masking use in LPDDR3 devices

	Segment Mask (MR17)	Bank 0	Bank 1	Bank 2	Bank 3	Bank 4	Bank 5	Bank 6	Bank 7
Bank Mask (MR16)		0	1	0	0	0	0	0	1
Segment 0	0		M						M
Segment 1	0		M						M
Segment 2	1	M	M	M	M	M	M	M	M
Segment 3	0		M						M
Segment 4	0		M						M
Segment 5	0		M						M
Segment 6	0		M						M
Segment 7	1	M	M	M	M	M	M	M	M

Note: 1. This table illustrates an example of an 8-bank LPDDR3 device, when a refresh operation to bank 1 and bank 7, as well as segment 2 and segment 7 are masked.

Mode Register Read (MRR) Command

The Mode Register Read (MRR) command is used to read configuration and status data from SDRAM mode registers. The MRR command is initiated with CS_n LOW, CA0 LOW, CA1 LOW, CA2 LOW, and CA3 HIGH at the rising edge of the clock. The mode register is selected by CA1f–CA0f and CA9r–CA4r. The mode register contents are available on the first data beat of DQ[7:0] after $RL \times t_{CK} + t_{DQSCk} + t_{DQSQ}$ following the rising edge of the clock where MRR is issued. Subsequent data beats contain valid but undefined content, except in the case of the DQ calibration function, where subsequent data beats contain valid content as described in the DQ Calibration specification. All DQS are toggled for the duration of the mode register read burst.

The MRR command has a burst length of eight. MRR operation (consisting of the MRR command and the corresponding data traffic) must not be interrupted.

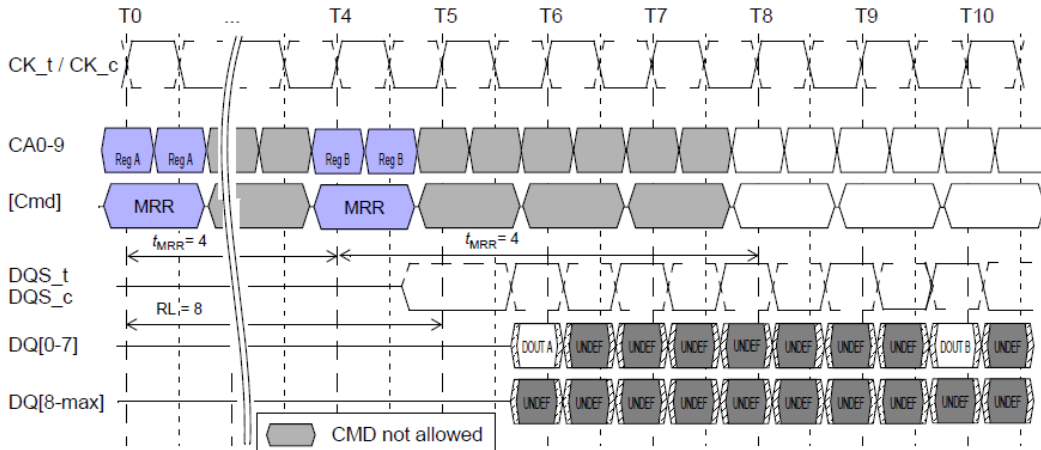

Mode Register Read timing example: RL = 8

Note:

1. MRRs to DQ calibration registers MR32 and MR40 are described in DQ calibration section.
2. Only the NOP command is supported during t_{MRR} .
3. Mode register data is valid only on DQ[7:0] on the first beat. Subsequent beats contain valid but undefined data. DQ[MAX:8] contain valid but undefined data for the duration of the MRR burst.
4. Minimum Mode Register Read to write latency is $RL + RU(t_{DQSCkmax}/t_{CK}) + 8/2 + 1$ - WL clock cycles.
5. Minimum Mode Register Read to Mode Register Write latency is $RL + RU(t_{DQSCkmax}/t_{CK}) + 8/2 + 1$ clock cycles.
6. In this example, $RL = 8$ for illustration purposes only.

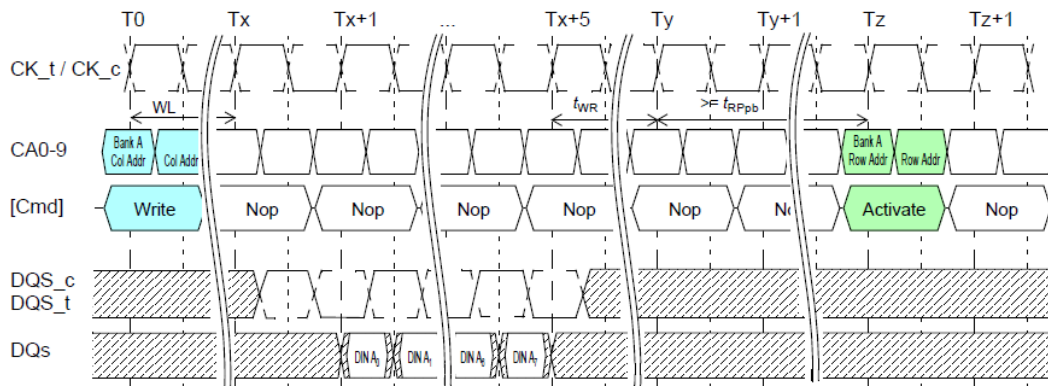

xREAD to MRR Timing

Note:

1. Only the NOP command is supported during t_{MRR} .
2. The minimum number of clock cycles from the burst READ command to the MRR command is BL/2.

After a prior READ command, the MRR command must not be issued earlier than BL/2 clock cycles, or WL + 1 + BL/2 + RU(t_{WTR}/t_{CK}) clock cycles after a prior WRITE command, as READ bursts and WRITE bursts must not be truncated by MRR.

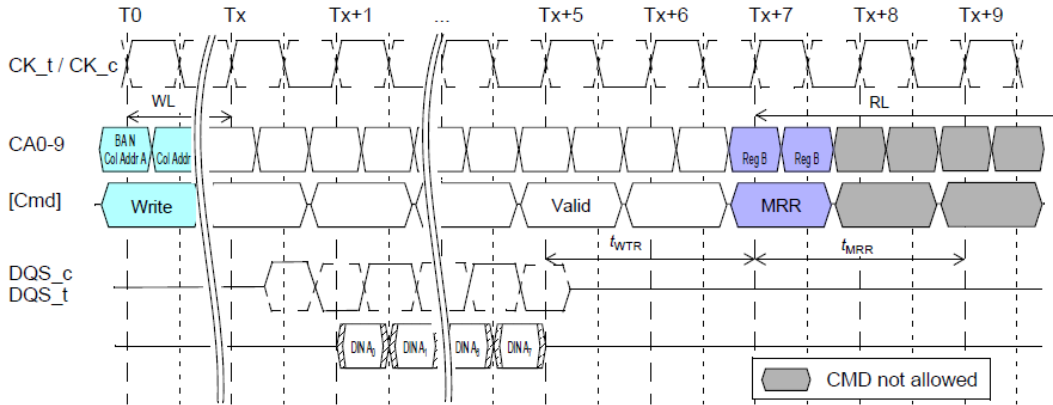

Burst Write Followed by MRR

Note:

1. The minimum number of clock cycles from the burst WRITE command to the MRR command is $[WL + 1 + BL/2 + RU(t_{WTR}/t_{CK})]$.
2. Only the NOP command is supported during t_{MRR} .

MRR Following Idle Power-Down State

Following the idle power-down state, an additional time, t_{MRRi} , is required prior to issuing the mode register read (MRR) command. This additional time (equivalent to t_{RCD}) is required in order to be able to maximize power-down current savings by allowing more power-up time for the MRR data path after exit from standby, idle power-down mode.

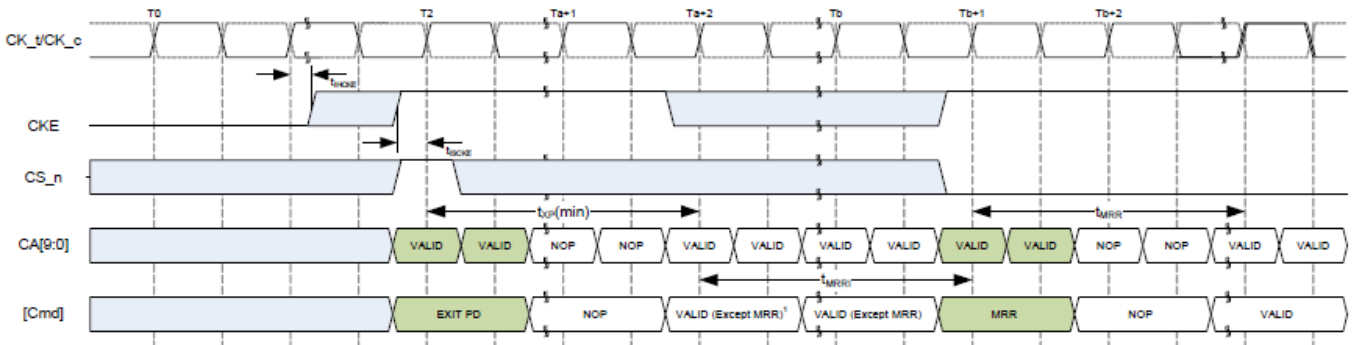

Notes:

1. Any valid command from the idle state except MRR
2. $t_{MRRi} = t_{RCD}$

MRR Following Power-Down Idle State

Temperature Sensor

LPDDR3 devices feature a temperature sensor whose status can be read from MR4. This sensor can be used to determine an appropriate refresh rate, determine whether AC timing de-rating is required in the elevated temperature range, and/or monitor the operating temperature. Either the temperature sensor or the device T_{OPER} (Operating Temperature Range table) may be used to determine whether operating temperature requirements are being met.

LPDDR3 devices shall monitor device temperature and update MR4 according to t_{TSI} . Upon exiting self-refresh or power-down, the device temperature status bits shall be no older than t_{TSI} .

When using the temperature sensor, the actual device case temperature may be higher than the T_{OPER} specification (Operating Temperature Range table) that applies for the standard or elevated temperature ranges. For example, T_{CASE} may be above 85°C when MR4[2:0] equals 011B. LPDDR3 devices shall allow for 2°C temperature margin between the point at which the device updates the MR4 value and the point at which the controller re-configures the system accordingly.

In the case of tight thermal coupling of the memory device to external hot spots, the maximum device temperature might be higher than what is indicated by MR4.

To assure proper operation using the temperature sensor, applications should consider the following factors:

- TempGradient is the maximum temperature gradient experienced by the memory device at the temperature of interest over a range of 2°C .
- ReadInterval is the time period between MR4 reads from the system.
- TempSensorInterval (t_{TSI}) is maximum delay between internal updates of MR4.
- SysRespDelay is the maximum time between a read of MR4 and the response by the system.

In order to determine the required frequency of polling MR4, the system shall use the maximum TempGradient and the maximum response time of the system using the following equation:

$$\text{TempGradient} \times (\text{ReadInterval} + t_{TSI} + \text{SysRespDelay}) \leq 2^{\circ}\text{C}$$

Temperature Sensor

Parameter	Symbol	Max/Min	Value	Unit	Notes
System Temperature Gradient	TempGradient	Max	System Dependent	$^{\circ}\text{C}/\text{s}$	
MR4 Read Interval	ReadInterval	Max	System Dependent	ms	
Temperature Sensor Interval	t_{TSI}	Max	32	ms	
System Response Delay	SysRespDelay	Max	System Dependent	ms	
Device Temperature Margin	TempMargin	Max	2	$^{\circ}\text{C}$	

For example, if TempGradient is $10^{\circ}\text{C}/\text{s}$ and the SysRespDelay is 1 ms:

$\frac{10^{\circ}\text{C}}{\text{s}}$	$\times (\text{ReadInterval} + 32\text{ms} + 1\text{ms}) \leq 2^{\circ}\text{C}$
---------------------------------------	--

In this case, ReadInterval shall be no greater than 167 ms.

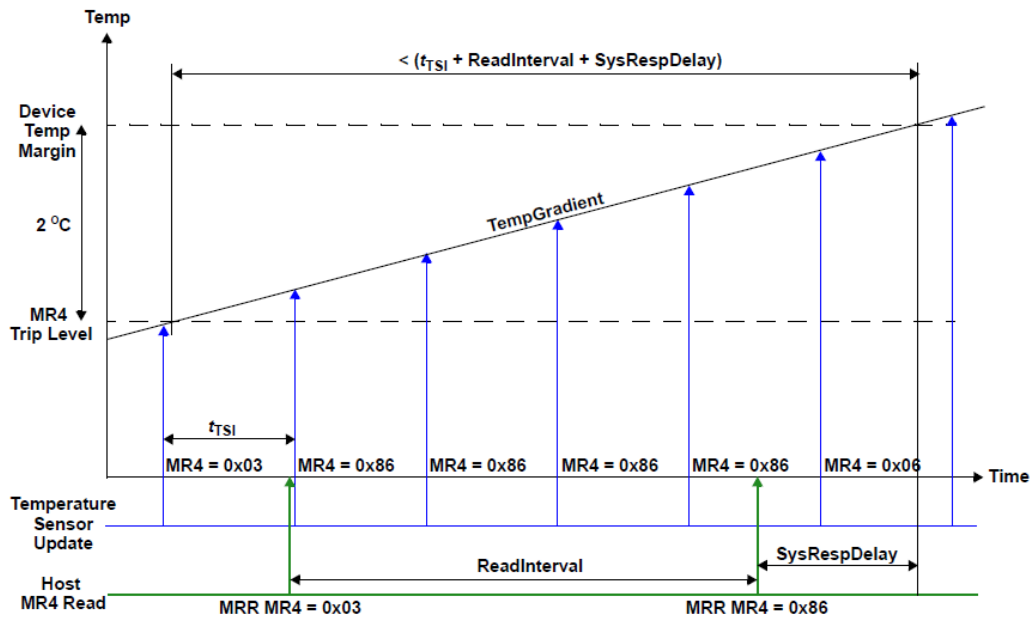

Temp Sensor Timing

DQ Calibration

LPDDR3 devices feature a DQ Calibration function that outputs one of two predefined system timing calibration patterns. A Mode Register Read to MR32 (Pattern "A") or MR40 (Pattern "B") will return the specified pattern on DQ[0] and DQ[8] for x16 devices.

For x16 devices, DQ[7:1] and DQ[15:9] may optionally drive the same information as DQ[0] or may drive 0b during the MRR burst.

Data Calibration Pattern Description

	Bit Time 0	Bit Time 1	Bit Time 2	Bit Time 3	Bit Time 4	Bit Time 5	Bit Time 6	Bit Time 7
Pattern "A" (MR32)	1	0	1	0	1	0	1	0
Pattern "B" (MR40)	0	0	1	1	0	0	1	1

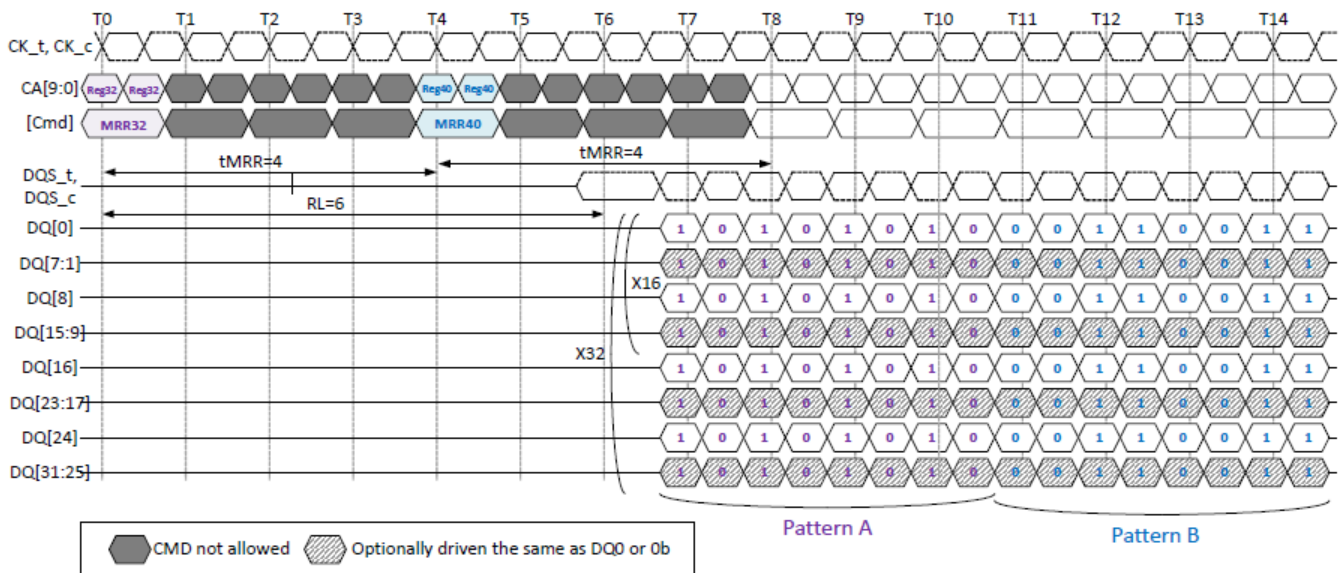

DQ Calibration Timing

Mode Register Write (MRW) Command

The Mode Register Write (MRW) command is used to write configuration data to mode registers. The MRW command is initiated with CS_n LOW, CA0 LOW, CA1 LOW, CA2 LOW, and CA3 LOW at the rising edge of the clock. The mode register is selected by CA1f-CA0f, CA9r-CA4r. The data to be written to the mode register is contained in CA9f-CA2f. The MRW command period is defined by t_{MRW} . Mode register WRITES to read-only registers have no impact on the functionality of the device.

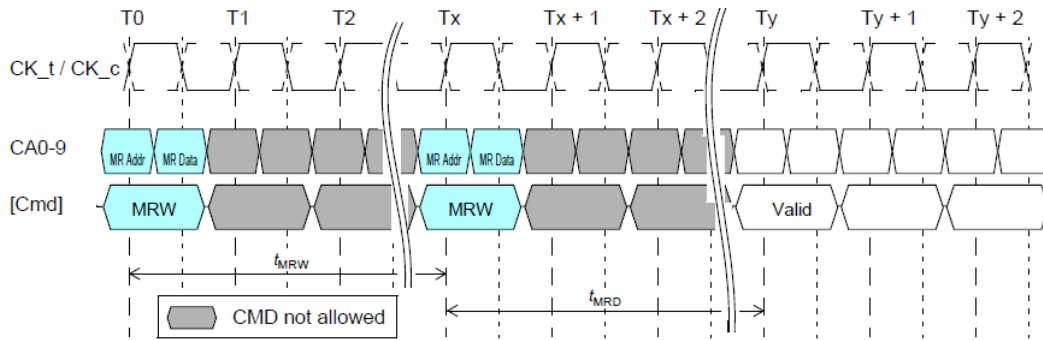

Mode Register Write Timing

Note:

1. At time T_y , the device is in the idle state.
2. Only the NOP command is supported during t_{MRW} .

Mode Register Write

MRW can only be issued when all banks are in the idle precharge state. One method of ensuring that the banks are in this state is to issue a PRECHARGE-ALL command.

MRW RESET

The MRW RESET command brings the device to the device auto-initialization (resetting) state in the power-on initialization sequence. The MRW RESET command can be issued from the idle state. This command resets all mode registers to their default values. After MRW RESET, boot timings must be observed until the device initialization sequence is complete and the device is in the idle state. Array data is undefined after the MRW RESET command.

If the initialization is to be performed at-speed (greater than the recommended boot clock frequency), then CA Training may be necessary to ensure setup and hold timings. Since the MRW RESET command is required prior to CA Training it may be difficult to meet setup and hold requirements. User may however choose the OP code 0xFC_H.

This encoding ensures that no transitions are required on the CA bus between rising and falling clock edge. Prior to CA Training, it is recommended to hold the CA bus stable for one cycle prior to, and one cycle after, the issuance of the MRW RESET command to ensure setup and hold timings on the CA bus.

Truth Table for Mode Register Read (MRR) and Mode Register Write (MRW)

Current State	Command	Intermediate State	Next State
All Banks Idle	MRR	Mode Register Reading (All Banks Idle)	All Banks Idle
	MRW	Mode Register Writing (All Banks Idle)	All Banks Idle
	MRW (RESET)	Resetting (Device Auto-Init)	All Banks Idle
Bank(s) Active	MRR	Mode Register Reading (Bank(s) Active)	Bank(s) Active
	MRW	Not Allowed	Not Allowed
	MRW (RESET)	Not Allowed	Not Allowed

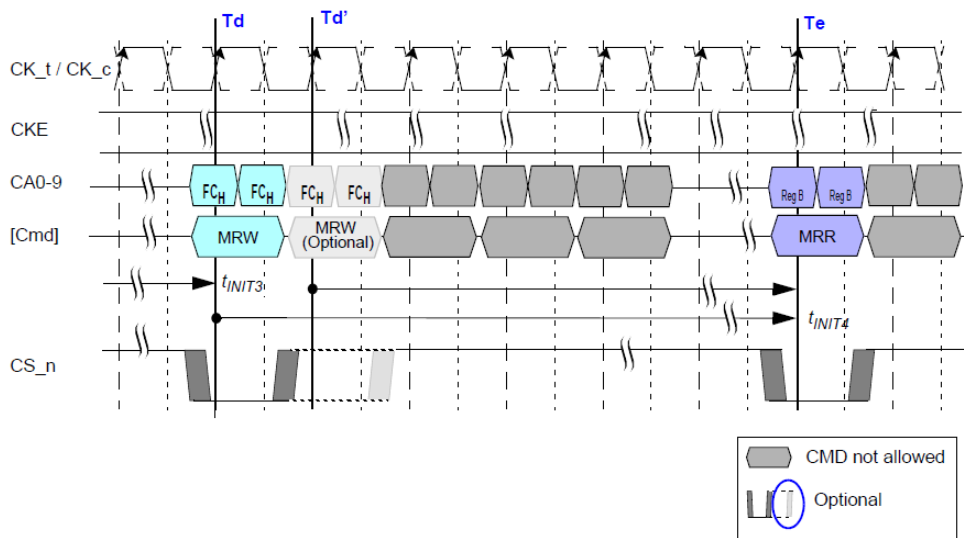

Mode Register Write Timing for MRW RESET

Note: 1. Optional MRW RESET command and optional CS_n assertion are allowed, When optional MRW RESET command is used, t_{INIT4} starts at T_{d'}.

Mode Register Write ZQ Calibration Command

The MRW command is used to initiate the ZQ calibration command. This command is used to calibrate the output driver impedance and on-die termination across process, temperature, and voltage. LPDDR3 devices support ZQ calibration.

There are four ZQ calibration commands and related timings: t_{ZQINIT} , $t_{ZQRESET}$, t_{ZQCL} , and t_{ZQCS} . t_{ZQINIT} is for initialization calibration; $t_{ZQRESET}$ is for resetting ZQ to the default output impedance; t_{ZQCL} is for long calibration(s); and t_{ZQCS} is for short calibration(s).

The initialization ZQ calibration (ZQINIT) must be performed for LPDDR3. ZQINIT provides an output impedance accuracy of ± 15 percent. After initialization, the ZQ calibration long (ZQCL) can be used to recalibrate the system to an output impedance accuracy of ± 15 percent. A ZQ calibration short (ZQCS) can be used periodically to compensate for temperature and voltage drift in the system. The ZQ reset command (ZQRESET) resets the output impedance calibration to a default accuracy of $\pm 30\%$ across process, voltage, and temperature. This command is used to ensure output impedance accuracy to $\pm 30\%$ when ZQCS and ZQCL commands are not used.

One ZQCS command can effectively correct at least 1.5% (ZQCorrection) of output impedance errors within t_{ZQCS} for all speed bins, assuming the maximum sensitivities specified are met. The appropriate interval between ZQCS commands can be determined from using these tables and system-specific parameters.

LPDDR3 devices are subject to temperature drift rate ($T_{driftrate}$) and voltage drift rate ($V_{driftrate}$) in various applications. To accommodate drift rates and calculate the necessary interval between ZQCS commands, apply the following formula:

$$\frac{ZQCorrection}{(TSens \times Tdriftrate) + (VSens \times Vdriftrate)} = CalibrationInterval$$

Where $T_{sens} = \text{MAX}(dR_{ONdT})$ and $V_{sens} = \text{MAX}(dR_{ONdV})$ define temperature and voltage sensitivities.

For example, if $T_{sens} = 0.75\%/^{\circ}\text{C}$, $V_{sens} = 0.20\%/mV$, $T_{driftrate} = 1^{\circ}\text{C}/\text{sec}$, and

$V_{driftrate} = 15mV/\text{sec}$, then the interval between ZQCS commands is calculated as:

$$\frac{1.5}{(0.75 \times 1) + (0.20 \times 15)} = 0.4s$$

A ZQ calibration command can only be issued when the device is in the idle state with all banks precharged. ODT shall be disabled via the mode register or the ODT pin prior to issuing a ZQ calibration command. No other activities can be performed on the data bus and the data bus shall be un-terminated during calibration periods (t_{ZQINIT} , t_{ZQCL} , or t_{ZQCS}). The quiet time on the data bus helps to accurately calibrate output impedance. There is no required quiet time after the ZQ RESET command. If multiple devices share a single ZQ resistor, only one device can be calibrating at any given time. After calibration is complete, the ZQ ball circuitry is disabled to reduce power consumption. In systems sharing a ZQ resistor between devices, the controller must prevent t_{ZQINIT} , t_{ZQCS} , and t_{ZQCL} overlap between the devices. ZQ RESET overlap is acceptable.

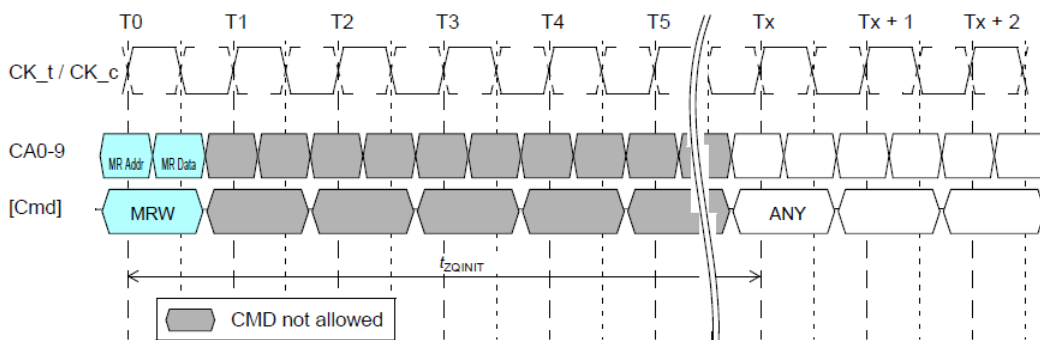

ZQ Initialization Timing

Note:

1. Only the NOP command is supported during ZQ calibration.
2. CKE must be registered HIGH continuously during the calibration period.
3. All devices connected to the DQ bus should be High-Z during the calibration process.

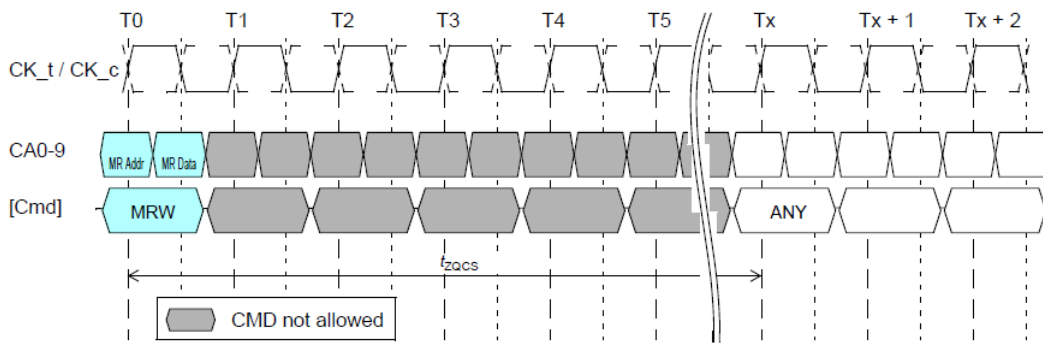

ZQ Calibration Short Timing

Note:

1. Only the NOP command is supported during ZQ calibration.
2. CKE must be registered HIGH continuously during the calibration period.
3. All devices connected to the DQ bus should be High-Z during the calibration process.

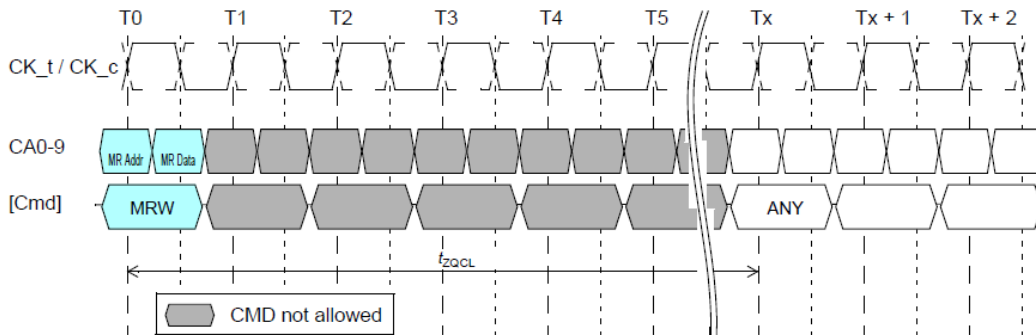

ZQ Calibration Long Timing

Note:

1. Only the NOP command is supported during ZQ calibration.
2. CKE must be registered HIGH continuously during the calibration period.
3. All devices connected to the DQ bus should be High-Z during the calibration process.

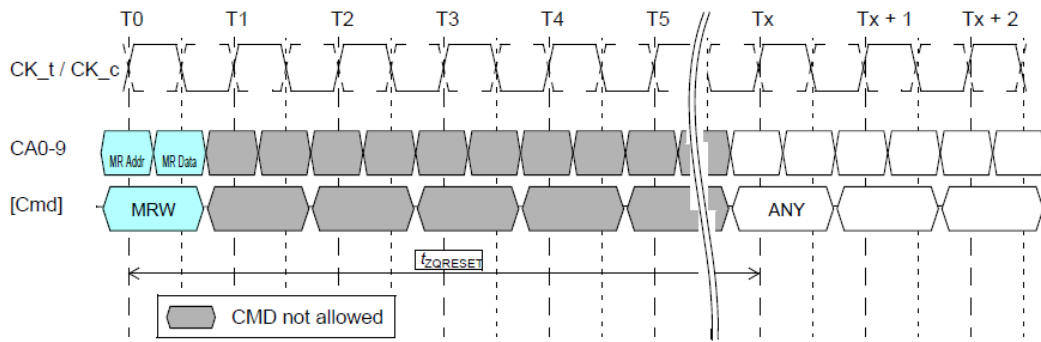

ZQ Calibration Reset Timing

Note:

1. Only the NOP command is supported during ZQ calibration.
2. CKE must be registered HIGH continuously during the calibration period.
3. All devices connected to the DQ bus should be High-Z during the calibration process.

ZQ External Resistor Value, Tolerance, and Capacitive Loading

To use the ZQ calibration function, an $RZQ \pm 1\%$ tolerance external resistor must be connected between the ZQ pin and ground. A single resistor can be used for each device or one resistor can be shared between multiple devices if the ZQ calibration timings for each device do not overlap. The total capacitive loading on the ZQ pin must be limited (see Pin Capacitance table, Input/output capacitance table).

Mode Register Write - CA Training Mode

Because CA inputs operate as double data rate, it may be difficult for memory controller to satisfy CA input setup/hold timings at higher frequency. A CA Training mechanism is provided.

CA Training Sequence

- a) CA Training mode entry: Mode Register Write to MR41
- b) CA Training session: Calibrate CA0, CA1, CA2, CA3, CA5, CA6, CA7 and CA8 (see CA to DQ mapping (CA Training mode enabled with MR41) table)
- c) CA to DQ mapping change: Mode Register Write to MR48
- d) Additional CA Training session: Calibrate remaining CA pins (CA4 and CA9) (see CA to DQ mapping (CA Training mode is enabled with MR48) table)
- e) CA Training mode exit: Mode Register Write to MR42

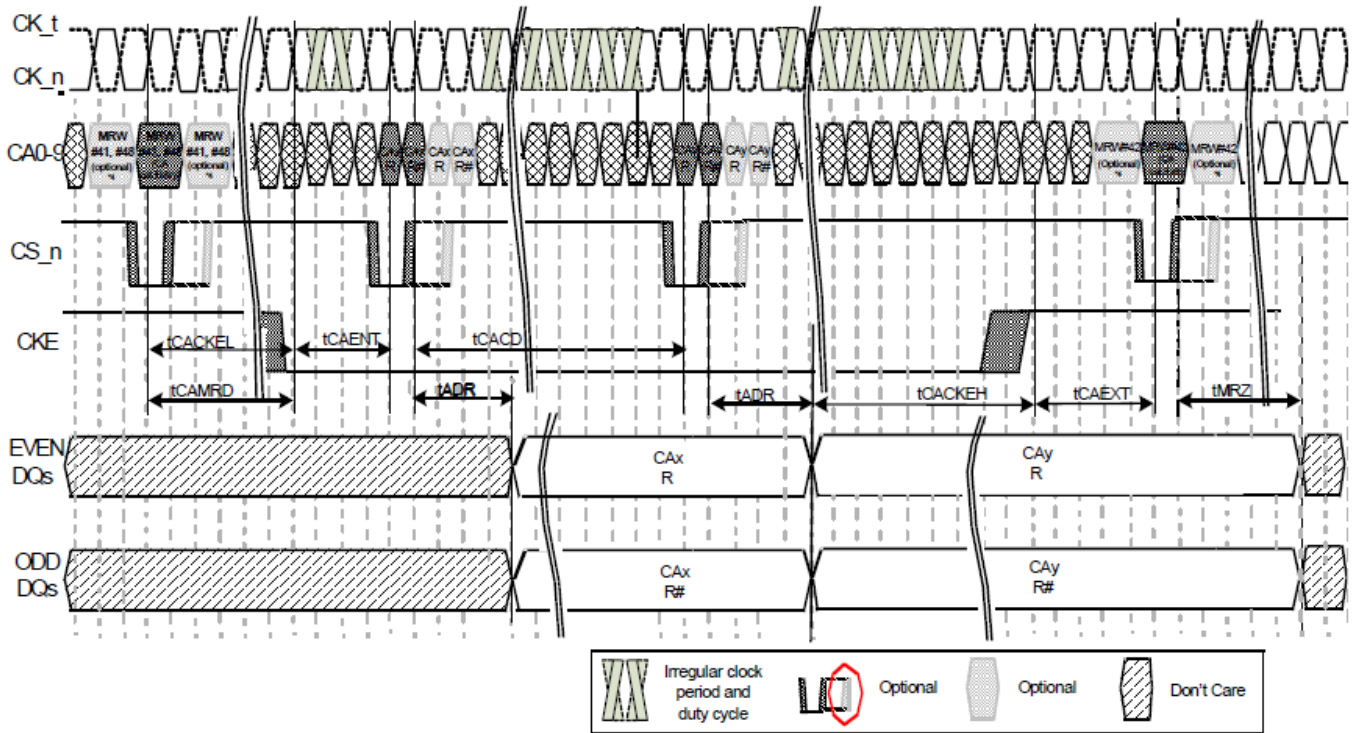

CA Training Timing Chart

Note:

1. Unused DQ must be valid HIGH or LOW during data output period. Unused DQ may transition at the same time as the active DQ. DQS must remain static and not transition.
2. CA to DQ mapping change via MR 48 omitted here for clarity of the timing diagram. Both MR41 and MR48 training sequences must be completed before exiting the training mode (MR42). To enable a CA to DQ mapping change, CKE must be driven HIGH prior to issuance of the MRW 48 command.
3. Because data out control is asynchronous and will be an analog delay from when all the CA data is available, t_{ADR} and t_{MRZ} are defined from CK_t falling edge.
4. It is recommended to hold the CA bus stable for one cycle prior to and one cycle after the issuance of the MRW CA training entry/exit command to ensure setup and hold timings on the CA bus.
5. Clock phase may be adjusted in CA training mode while CS_n is high and CKE is low resulting in an irregular clock with shorter/longer periods and pulse widths.
6. Optional MRW 41, 48, 42 command and CA calibration command are allowed. To complement these optional commands, optional CS_n assertions are also allowed. All timing must comprehend these optional CS_n assertions:
 - a) t_{ADR} starts at the falling clock edge after the last registered CS_n assertion.
 - b) t_{CACD} , t_{CACKEL} , t_{CAMRD} start with the rising clock edge of the last CS_n assertion.
 - c) t_{CAENT} , t_{CAEXT} need to be met by the first CS_n assertion.
 - d) t_{MRZ} will be met after the falling clock edge following the first CS_n assertion with exit (MRW#42) command.

The LPDDR3 SDRAM may not properly recognize a Mode Register Write command at normal operation frequency before CA Training is finished. Special encodings are provided for CA Training mode enable/disable. MR41 and MR42 encodings are selected so that rising edge and falling edge values are the same. The LPDDR3 SDRAM will recognize MR41 and MR42 at normal operation frequency even before CA timing adjustment is finished.

Calibration data will be output through DQ pins. CA to DQ mapping is described in Table.

After timing calibration with MR41 is finished, users will issue MRW to MR48 and calibrate remaining CA pins (CA4 and CA9) using (DQ0/DQ1 and DQ8/DQ9) as calibration data output pins (see CA to DQ mapping (CA Training mode is enabled with MR48) table).

CA Training timing values are specified in the AC Timing Table.

CA Training mode enable (MR41(29H, 0010 1001B), OP=A4H(1010 0100B))

	CA0	CA1	CA2	CA3	CA4	CA5	CA6	CA7	CA8	CA9
Rising Edge	L	L	L	L	H	L	L	H	L	H
Falling Edge	L	L	L	L	H	L	L	H	L	H

CA Training mode disable (MR42(2AH,0010 1010B),OP=A8H(1010 1000B))

	CA0	CA1	CA2	CA3	CA4	CA5	CA6	CA7	CA8	CA9
Rising Edge	L	L	L	L	L	H	L	H	L	H
Falling Edge	L	L	L	L	L	H	L	H	L	H

CA to DQ mapping (CA Training mode enabled with MR41)

CA0	CA1	CA2	CA3	CA5	CA6	CA7	CA8	Clock edge
DQ0	DQ2	DQ4	DQ6	DQ8	DQ10	DQ12	DQ14	CK_t rising edge
DQ1	DQ3	DQ5	DQ7	DQ9	DQ11	DQ13	DQ15	CK_t falling edge

CA Training mode enable (MR48(30H, 0011 0000B), OP=C0H(1100 0000B))

	CA0	CA1	CA2	CA3	CA4	CA5	CA6	CA7	CA8	CA9
Rising Edge	L	L	L	L	L	L	L	L	H	H
Falling Edge	L	L	L	L	L	L	L	L	H	H

CA to DQ mapping (CA Training mode is enabled with MR48)

CA4	CA9	Clock edge
DQ0	DQ8	CK_t rising edge
DQ1	DQ9	CK_t falling edge

Note: 1. Other DQs must have valid output (either HIGH or LOW)

Mode Register Write - WR Leveling Mode

In order to provide for improved signal integrity performance, the LPDDR3 SDRAM provides a write leveling feature to compensate for timing skew, affecting timing parameters such as t_{DQSS} , t_{DSS} , and t_{DSH} .

The memory controller uses the write leveling feature to receive feedback from the SDRAM allowing it to adjust the clock to data strobe signal relationship for each DQS_t/DQS_c signal pair. The memory controller performing the leveling must have adjustable delay setting on DQS_t/DQS_c signal pair to align the rising edge of DQS signals with that of the clock signal at the DRAM pin. The DRAM asynchronously feeds back CLK, sampled with the rising edge of DQS signals. The controller repeatedly delays DQS signals until a transition from 0 to 1 is detected. The DQS signals delay established through this exercise ensures the t_{DQSS} specification can be met.

All DQS signals may have to be leveled independantly. During Write Leveling operations each DQS signal latches the clock with a rising strobe edge and drives the result on all DQ[n] of its respective byte.

The LPDDR3 SDRAM enters into write leveling mode when mode register MR2[7] is set HIGH. When entering write leveling mode, the state of the DQ pins is undefined. During write leveling mode, only NOP commands are allowed, or MRW command to exit write leveling operation. Upon completion of the write leveling operation, the DRAM exits from write leveling mode when MR2[7] is reset LOW.

The controller will drive DQS_t LOW and DQS_c HIGH after a delay of $t_{WLDQSEN}$. After time t_{WLMRD} , the controller provides DQS signal input which is used by the DRAM to sample the clock signal driven from the controller. The delay time $t_{WLMRD(max)}$ is controller dependent. The DRAM samples the clock input with the rising edge of DQS and provides asynchronous feedback on all the DQ bits after time t_{WLO} . The controller samples this information and either increment or decrement the DQS_t and/or DQS_c delay settings and launches the next DQS/DQS# pulse. The sample time and trigger time is controller dependent. Once the following DQS_t/DQS_c transition is sampled, the controller locks the strobe delay settings, and write leveling is achieved for the device.

Write Leveling Timing figure describes the timing for the write leveling operation.

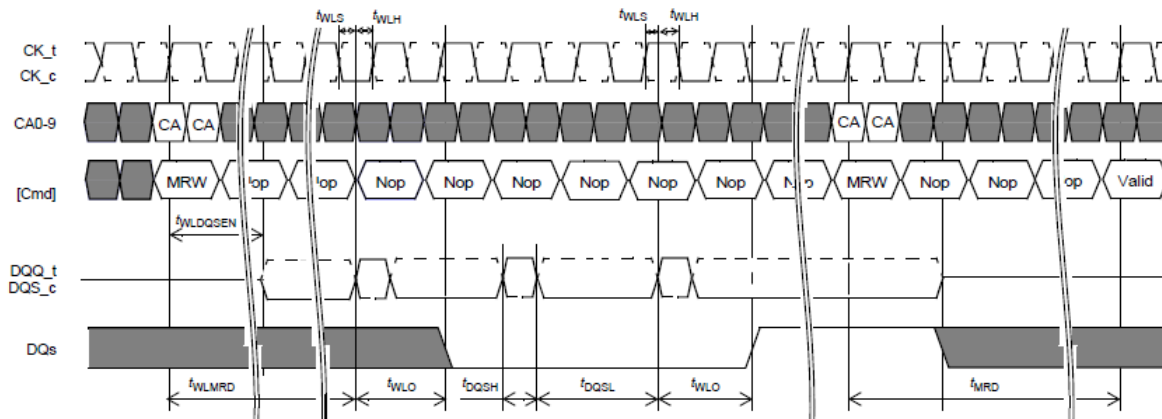

Write Leveling Timing

On-Die Termination

ODT (On-Die Termination) is a feature of the LPDDR3 SDRAM that allows the DRAM to turn on/off termination resistance for each DQ, DQS_t, DQS_c and DM via the ODT control pin. The ODT feature is designed to improve signal integrity of the memory channel by allowing the DRAM controller to independently turn on/off termination resistance for any or all DRAM devices. Unlike other command inputs, the ODT pin directly controls ODT operation and is not sampled by the clock.

The ODT feature is turned off and not supported in Self-Refresh and Deep Power Down modes. ODT operation can optionally be enabled during CKE Power Down via a mode register. Note that if ODT is enabled during Power Down mode V_{DDQ} may not be turned off during Power Down. The DRAM will also disable termination during read operations.

A simple functional representation of the DRAM ODT feature is shown in Functional Representation of ODT figure.

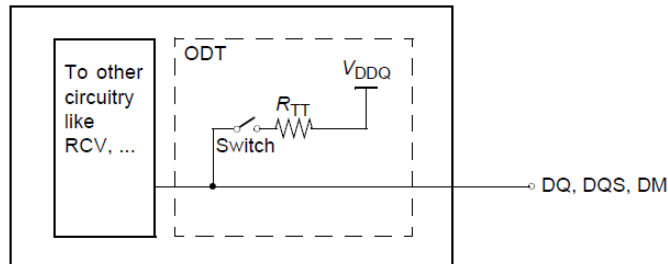

Functional Representation of ODT

The switch is enabled by the internal ODT control logic, which uses the external ODT pin and other mode register control information. The value of R_{TT} is determined by the settings of Mode Register bits. The ODT pin will be ignored if the Mode Register MR11 is programmed to disable ODT, in self-refresh, in deep power down, in CKE power down (mode register option) and during read operations.

ODT Mode Register

The ODT Mode is enabled if MR11 OP<1:0> are non zero. In this case, the value of R_{TT} is determined by the settings of those bits. The ODT Mode is disabled if MR11 OP<1:0> are zero.

MR11 OP<2> determines whether ODT, if enabled through MR11 OP<1:0>, will operate during CKE power down.

Asynchronous ODT

The ODT feature is controlled asynchronously based on the status of the ODT pin, except ODT is off when:

- ODT is disabled through MR11 OP<1:0>
- DRAM is performing a read operation (RD or MRR)
- DRAM is in CKE Power Down and MR11 OP<2> is zero
- DRAM is in Self-Refresh or Deep Power Down modes.
- DRAM is in CA Training Mode.

In asynchronous ODT mode, the following timing parameters apply when ODT operation is controlled by the ODT pin:

$t_{ODTon,min,max}$, $t_{ODToff,min,max}$

Minimum R_{TT} turn-on time ($t_{ODTon,min}$) is the point in time when the device termination circuit leaves high impedance state and ODT resistance begins to turn on. Maximum R_{TT} turn on time ($t_{ODTon,max}$) is the point in time when the ODT resistance is fully on. $t_{ODToff,min}$ and $t_{ODTon,max}$ are measured from ODT pin high.

Minimum R_{TT} turn-off time ($t_{ODToff,min}$) is the point in time when the device termination circuit starts to turn off the ODT resistance. Maximum ODT turn off time ($t_{ODToff,max}$) is the point in time when the on-die termination has reached high impedance. $t_{ODToff,min}$ and $t_{ODToff,max}$ are measured from ODT pin low.

ODT During Read Operations (RD or MRR)

During read operations, LPDDR3 SDRAM will disable termination and disable ODT control through the ODT pin. After read operations are completed, ODT control is resumed through the ODT pin (if ODT Mode is enabled).

ODT During Power Down

When MR11 OP<2> is zero, termination control through the ODT pin will be disabled when the DRAM enters CKE power down. After a power down command is registered, termination will be disabled within a time window specified by $t_{ODTd,min,max}$. After a power down exit command is registered, termination will be enabled within a time window specified by $t_{ODTe,min,max}$.

Minimum RTT disable time ($t_{ODTd,min}$) is the point in time when the device termination circuit will no longer be controlled by the ODT pin. Maximum ODT disable time ($t_{ODTd,max}$) is the point in time when the on-die termination will be in high impedance.

Minimum RTT enable time ($t_{ODTe,min}$) is the point in time when the device termination circuit will no longer be in high impedance. The ODT pin shall control the device termination circuit after maximum ODT enable time ($t_{ODTe,max}$) is satisfied.

When MR11 OP<2> is enabled and MR11 OP<1:0> are non zero, ODT operation is supported during CKE power down with ODT control through the ODT pin.

ODT During Self Refresh

LPDDR3 SDRAM disables the ODT function during self refresh. After a self refresh command is registered, termination will be disabled within a time window specified by $t_{ODTd,min,max}$. After a self refresh exit command is registered, termination will be enabled within a time window specified by $t_{ODTe,min,max}$.

ODT During Deep Power Down

LPDDR3 SDRAM disables the ODT function during deep power down. After a deep power down command is registered, termination will be disabled within a time window specified by $t_{ODTd,min,max}$.

ODT During CA Training and Write Leveling

During CA Training Mode, LPDDR3 SDRAM will disable on-die termination and ignore the state of the ODT control pin. For ODT operation during Write Leveling mode, refer to the DRAM Termination Function In Write Leveling Mode table for termination activation and deactivation for DQ and DQS_t/DQS_c.

DRAM Termination Function In Write Leveling Mode

ODT pin	DQS_t/DQS_c termination	DQ termination
de-asserted	OFF	OFF
asserted	ON	OFF

If ODT is enabled, the ODT pin must be high, in Write Leveling mode.

ODT States Truth Table

	Write	Read/ DQ Cal	ZQ Cal	CA Training	Write Level
DQ Termination	Enabled	Disabled	Disabled	Disabled	Disabled
DQS Termination	Enabled	Disabled	Disabled	Disabled	Enabled

Note: 1. ODT is enabled with MR11[1:0]=01b, 10b, or 11b and ODT pin HIGH. ODT is disabled with MR11[1:0]=00b or ODT pin LOW.

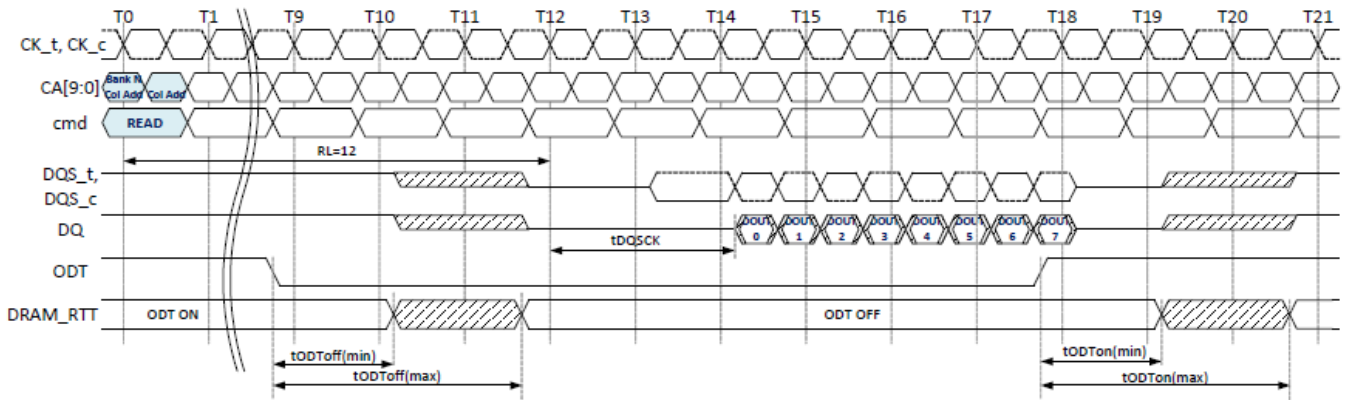

Asynchronous ODT Timing Example for RL = 12

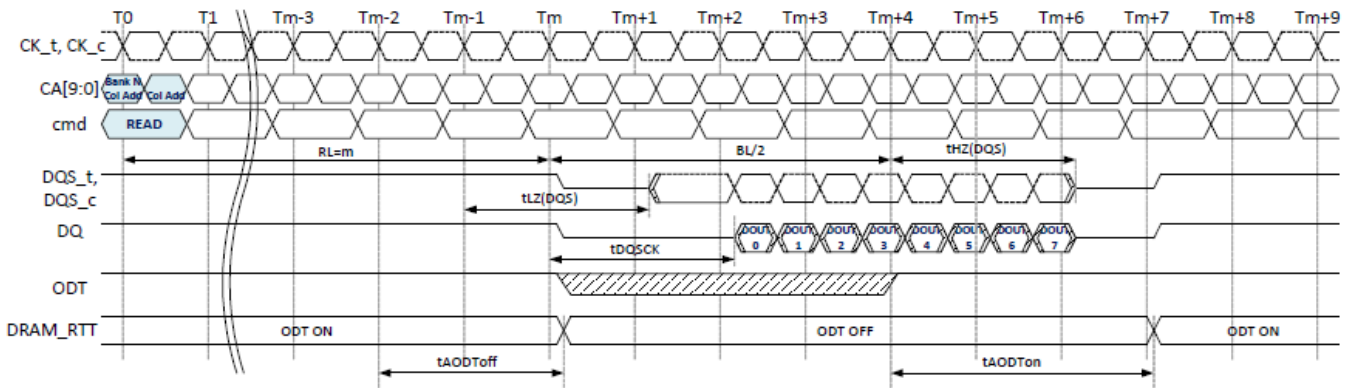

Automatic ODT Timing During READ Operation Example for RL = m

Note:

1. The automatic R_{TT} turn-off delay, t_{AODTOff}, is referenced from the rising edge of “RL-2” clock at T_{m-2}.
2. The automatic R_{TT} turn-on delay, t_{AODTon}, is referenced from the rising edge of “RL+ BL/2” clock at T_{m+4}.

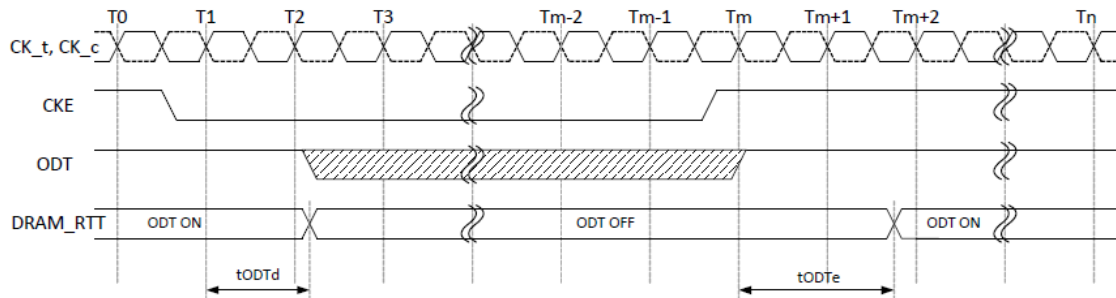

ODT Timing During Power Down, Self Refresh, Deep Power Down Entry/Exit Example

Note:

1. Upon exit of Deep Power Down mode, a complete power-up initialization sequence is required.
2. t_{ODTd} has a different value if the command at T₁ is normal Power Down entry, Deep Power Down entry or Self Refresh entry; see “AC Timing” table.

Power-down

Power-down is entered synchronously when CKE is registered LOW and CS_n is HIGH at the rising edge of clock.

CKE must not go LOW while MRR, MRW, READ, or WRITE operations are in progress. CKE can go LOW while any other operations such as row activation, PRECHARGE, auto precharge, or REFRESH are in progress, but the power-down IDD specification will not be applied until such operations are complete. Power-down entry and exit are shown in Basic Power-Down Entry and Exit Timing figure through MRW to Power-Down Entry figure.

Entering power-down deactivates the input and output buffers, excluding CKE. To ensure that there is enough time to account for internal delay on the CKE signal path, two NOP commands are required after CKE is driven LOW, this timing period is defined as t_{CPDED}. CKE LOW will result in deactivation of input receivers after t_{CPDED} has expired.

In power-down mode, CKE must be held LOW; all other input signals are “Don’t Care.” CKE LOW must be maintained until t_{CKE,min} is satisfied. V_{REFCA} must be maintained at a valid level during power-down.

V_{DDQ} can be turned off during power-down. If V_{DDQ} is turned off, V_{REFDQ} must also be turned off. Prior to exiting power-down, both V_{DDQ} and V_{REFDQ} must be within their respective minimum/maximum operating ranges.

No refresh operations are performed in power-down mode. The maximum duration in power-down mode is only limited by the refresh requirements outlined in the Refresh command section.

The power-down state is exited when CKE is registered HIGH. The controller must drive CS_n HIGH in conjunction with CKE HIGH when exiting the power-down state. CKE HIGH must be maintained until t_{CKE,min} is satisfied. A valid, executable command can be applied with power-down exit latency t_{XP} after CKE goes HIGH. Power-down exit latency is defined in the AC timing parameter table.

If power-down occurs when all banks are idle, this mode is referred to as idle power-down; if power-down occurs when there is a row active in any bank, this mode is referred to as active power-down. For the description of ODT operation and specifications during power-down entry and exit, see section On-Die Termination.

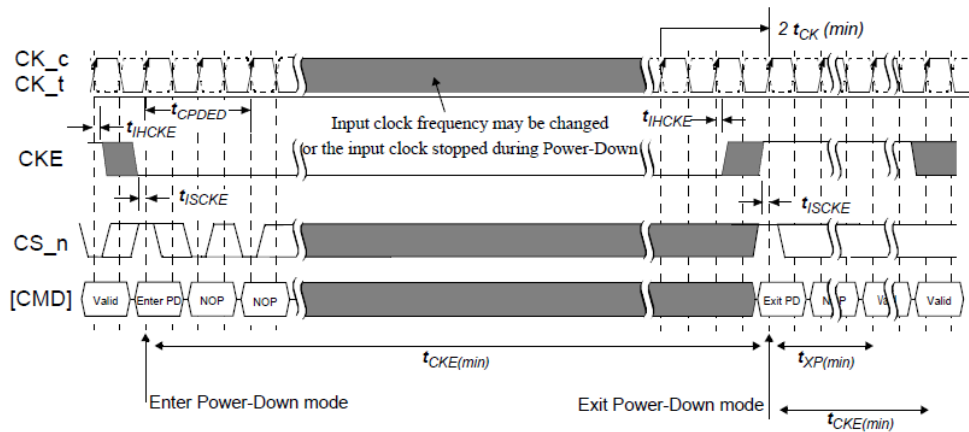

Basic Power-Down Entry and Exit Timing

Note: 1. Input clock frequency can be changed or the input clock can be stopped or floated during power-down, provided that upon exiting power-down, the clock is stable and within specified limits for a minimum of 2 clock cycles prior to power-down exit and the clock frequency is between the minimum and maximum specified frequency for the speed grade in use.

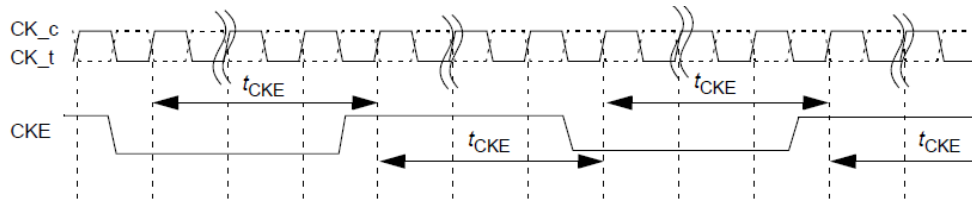

CKE-Intensive Environment

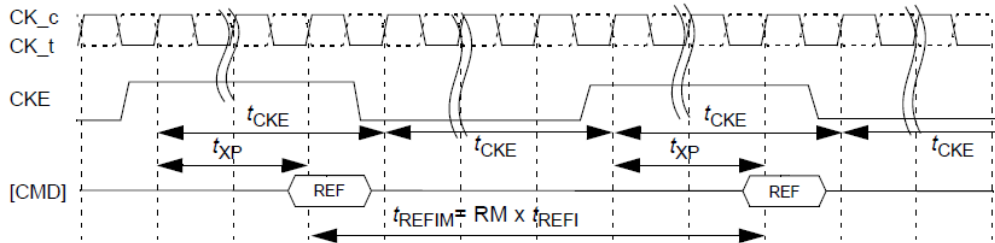

REFRESH-to-REFRESH Timing in CKE-Intensive Environments

Note: 1. The pattern shown can repeat over an extended period of time. With this pattern, all AC and DC timing and voltage specifications with temperature and voltage drift are ensured.

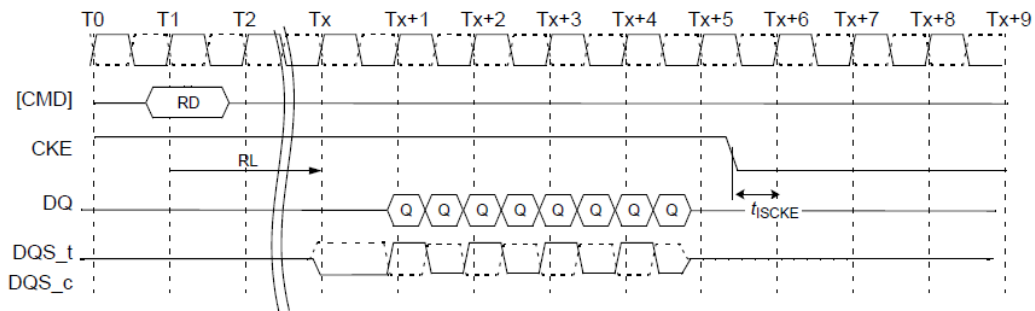

READ to Power-Down Entry

Note:

1. CKE must be held HIGH until the end of the burst operation.
2. CKE can be registered LOW at $RL + RU(t_{DQCK(MAX)}/t_{CK}) + BL/2 + 1$ clock cycles after the clock on which the READ command is registered.

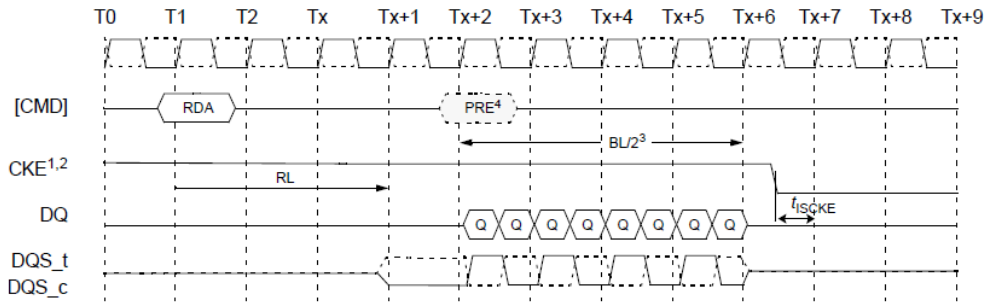

READ with Auto Precharge to Power-Down Entry

Note:

1. CKE must be held HIGH until the end of the burst operation.
2. CKE can be registered LOW at $RL + RU(t_{DQSCk}/t_{CK}) + BL/2 + 1$ clock cycles after the clock on which the READ command is registered.
3. $BL/2$ with $t_{RTP} = 7.5ns$ and $t_{RAS(MIN)}$ is satisfied.
4. Start internal PRECHARGE.

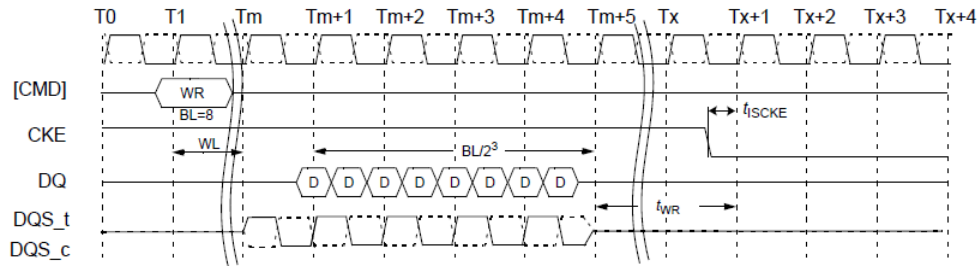

WRITE to Power-Down Entry

Note: 1. CKE can be registered LOW at $WL + 1 + BL/2 + RU(t_{WR}/t_{CK})$ clock cycles after the clock on which the WRITE command is registered.

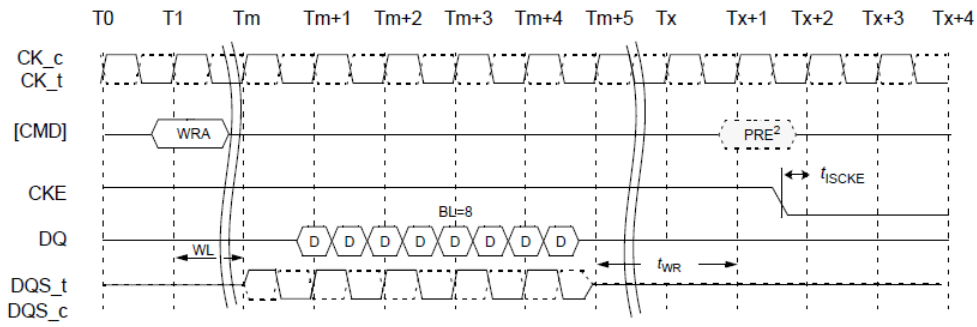

WRITE with Auto Precharge to Power-Down Entry

Note:

1. CKE can be registered LOW at $WL + 1 + BL/2 + RU(t_{WR}/t_{CK}) + 1$ clock cycles after the WRITE command is registered.
2. Start internal PRECHARGE.

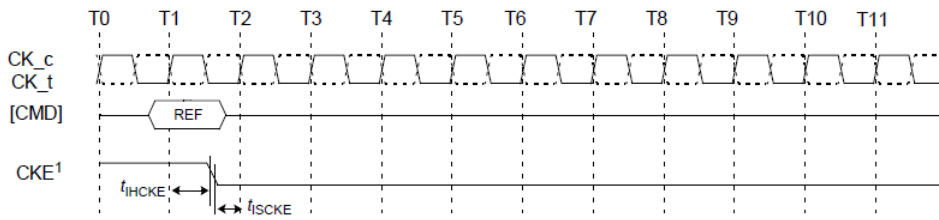

REFRESH Command to Power-Down Entry

- Note:** 1. CKE can go LOW t_{IHCKE} after the clock on which the REFRESH command is registered.

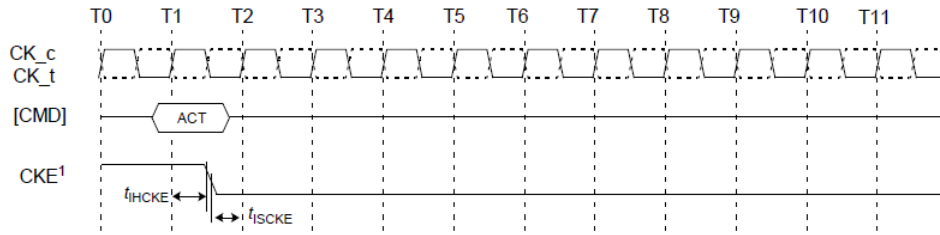
**ACTIVATE Command to Power-Down Entry**

Note: 1. CKE can go LOW at t_{HCKE} after the clock on which the ACTIVATE command is registered.

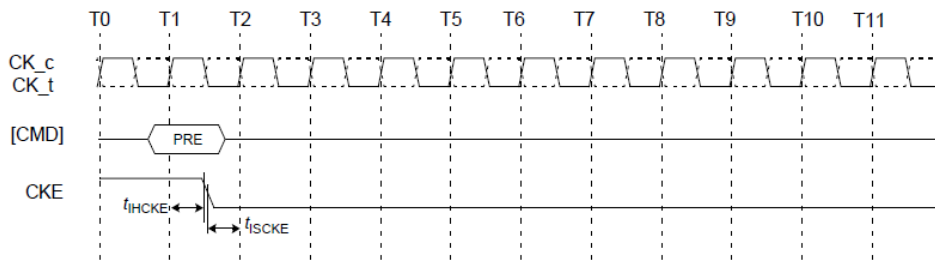
**PRECHARGE Command to Power-Down Entry**

Note: 1. CKE can go LOW t_{HCKE} after the clock on which the PRECHARGE command is registered.

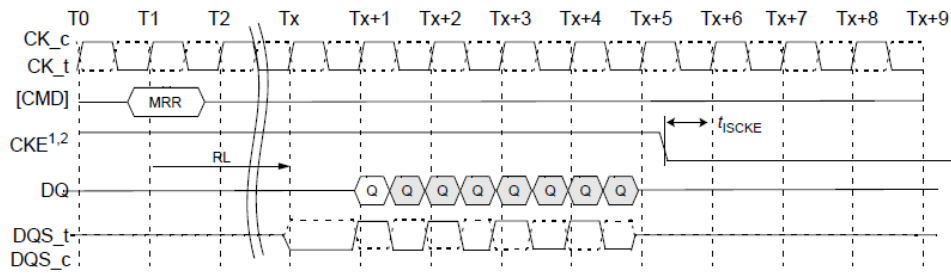

MRR to Power-Down Entry

Note:

1. CKE can be registered LOW $RL + RU(t_{DQSCk}/t_{CK}) + BL/2 + 1$ clock cycles after the clock on which the MRR command is registered.
2. CKE should be held high until the end of the burst operation.

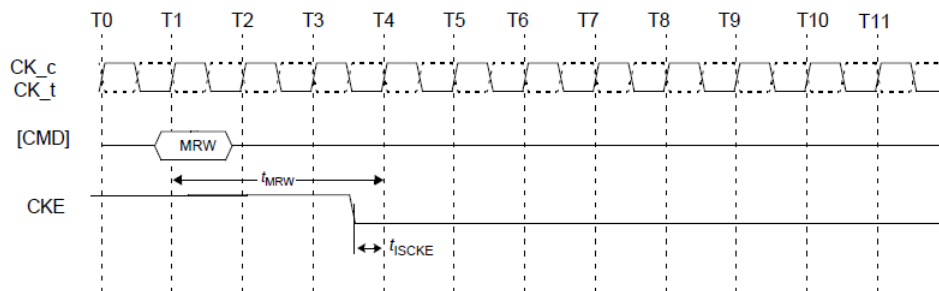

MRW to Power-Down Entry

Note: 1. CKE can be registered LOW t_{MRW} after the clock on which the MRW command is registered.

Deep Power-Down

Deep Power-Down is entered when CKE is registered LOW with CS_n LOW, CA0 HIGH, CA1 HIGH, and CA2 LOW at the rising edge of clock. All banks must be in idle state with no activity on the data bus prior to entering the Deep Power Down mode. During Deep Power-Down, CKE must be held LOW. The contents of the SDRAM will be lost upon entry into Deep Power-Down mode.

In Deep Power-Down mode, all input buffers except CKE, all output buffers, and the power supply to internal circuitry may be disabled within the SDRAM. To ensure that there is enough time to account for internal delay on the CKE signal path, two NOP commands are required after CKE is driven LOW, this timing period is defined as t_{CPDED} .

CKE LOW will result in deactivation of command and address receivers after t_{CPDED} has expired. All power supplies must be within specified limits prior to exiting Deep Power-Down. V_{refDQ} and V_{refCA} may be at any level within minimum and maximum levels (see Absolute Maximum Ratings). However prior to exiting Deep Power-Down, V_{ref} must be within specified limits (See Recommended DC Operating Conditions).

The Deep Power-Down state is exited when CKE is registered HIGH, while meeting t_{ISCKE} with a stable clock input.

The SDRAM must be fully re-initialized as described in the power up initialization Sequence. The SDRAM is ready for normal operation after the initialization sequence is completed. For the description of ODT operation and specifications during DPD entry and exit, see section On-Die Termination.

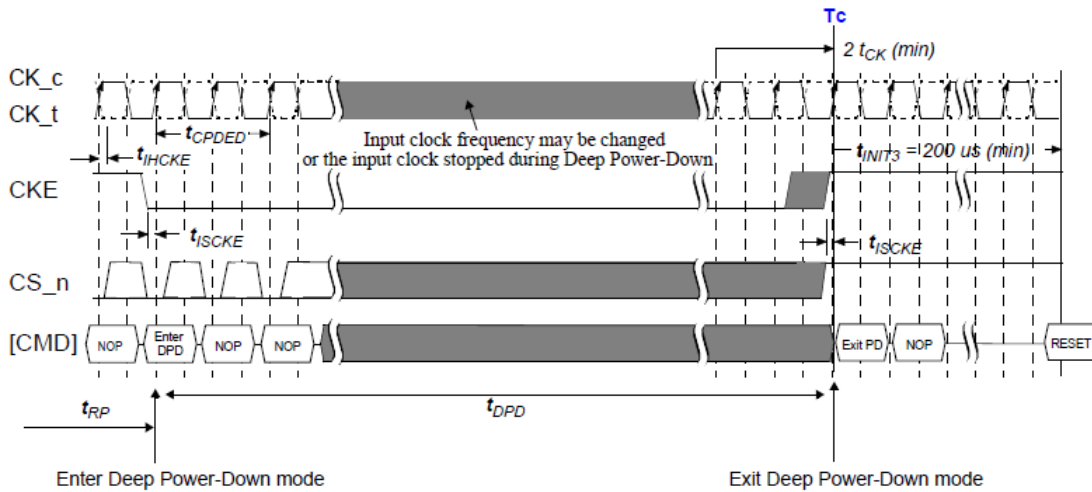

Deep power down entry and exit timing diagram

Note:

1. Initialization sequence may start at any time after T_c .
2. t_{INIT3} , and T_c refer to timings in the LPDDR3 initialization sequence. For more detail, see Power-Up and Initialization.
3. Input clock frequency may be changed or the input clock can be stopped or floated during deep powerdown, provided that upon exiting deep power-down, the clock is stable and within specified limits for a minimum of 2 clock cycles prior to deep power-down exit and the clock frequency is between the minimum and maximum frequency for the particular speed grade.

Input clock stop and frequency change

LPDDR3 SDRAMs support input clock frequency change during CKE LOW under the following conditions:

- $t_{CK(ABS)min}$ is met for each clock cycle;
- Refresh requirements apply during clock frequency change;
- During clock frequency change, only REFab or REFpb commands may be executing;
- Any Activate or Precharge commands have executed to completion prior to changing the frequency;
- The related timing conditions (t_{RCD} , t_{RP}) have been met prior to changing the frequency;
- The initial clock frequency shall be maintained for a minimum of 2 clock cycles after CKE goes LOW;
- The clock satisfies $t_{CH(ABS)}$ and $t_{CL(ABS)}$ for a minimum of 2 clock cycles prior to CKE going HIGH.

After the input clock frequency is changed and CKE is held HIGH, additional MRW commands may be required to set the WR, RL etc. These settings may need to be adjusted to meet minimum timing requirements at the target clock frequency.

LPDDR3 devices support clock stop during CKE LOW under the following conditions:

- CK_t is held LOW and CK_c is held HIGH or both are floated during clock stop;
- Refresh requirements apply during clock stop;
- During clock stop, only REFab or REFpb commands may be executing;
- Any Activate or Precharge commands have executed to completion prior to stopping the clock;
- The related timing conditions (t_{RCD} , t_{RP}) have been met prior to stopping the clock;
- The initial clock frequency shall be maintained for a minimum of 2 clock cycles after CKE goes LOW;
- The clock satisfies $t_{CH(ABS)}$ and $t_{CL(ABS)}$ for a minimum of 2 clock cycles prior to CKE going HIGH.

LPDDR3 devices support input clock frequency change during CKE HIGH under the following conditions:

- $t_{CK(ABS)min}$ is met for each clock cycle;
- Refresh requirements apply during clock frequency change;
- Any Activate, Read, Write, Precharge, Mode Register Write, or Mode Register Read commands must have executed to completion, including any associated data bursts prior to changing the frequency;
- The related timing conditions (t_{RCD} , t_{WR} , t_{WRA} , t_{RP} , t_{MRW} , t_{MRR} , etc.) have been met prior to changing the frequency;
- CS_n shall be held HIGH during clock frequency change;
- During clock frequency change, only REFab or REFpb commands may be executing;
- The LPDDR3 SDRAM is ready for normal operation after the clock satisfies $t_{CH(ABS)}$ and $t_{CL(ABS)}$ for a minimum of $2 \cdot t_{CK} + t_{XP}$.

After the input clock frequency is changed, additional MRW commands may be required to set the WR, RL etc. These settings may need to be adjusted to meet minimum timing requirements at the target clock frequency.

LPDDR3 devices support clock stop during CKE HIGH under the following conditions:

- CK_t is held LOW and CK_c is held HIGH during clock stop;
- CS_n shall be held HIGH during clock stop;
- Refresh requirements apply during clock stop;
- During clock stop, only REFab or REFpb commands may be executing;
- Any Activate, Read, Write, Precharge, Mode Register Write, or Mode Register Read commands must have executed to completion, including any associated data bursts prior to stopping the clock;
- The related timing conditions (t_{RCD} , t_{WR} , t_{WRA} , t_{RP} , t_{MRW} , t_{MRR} , etc.) have been met prior to stopping the clock;
- The LPDDR3 SDRAM is ready for normal operation after the clock is restarted and satisfies $t_{CH(ABS)}$ and $t_{CL(ABS)}$ for a minimum of $2 \cdot t_{CK} + t_{XP}$.

No Operation command

The purpose of the No Operation command (NOP) is to prevent the LPDDR3 device from registering any unwanted command between operations. Only when the CKE level is constant for clock cycle N-1 and clock cycle N, a NOP command may be issued at clock cycle N. A NOP command has two possible encodings:

1. CS_n HIGH at the clock rising edge N.
2. CS_n LOW and CA0, CA1, CA2 HIGH at the clock rising edge N.













The No Operation command will not terminate a previous operation that is still executing, such as a burst read or write cycle.

Truth tables

Operation or timing that is not specified is illegal, and after such an event, in order to guarantee proper operation, the LPDDR3 device must be powered down and then restarted through the specified initialization sequence before normal operation can continue.

Command Truth Table

SDRAM Command	SDR Command Pins		DDR CA pins (10)											CK_t EDGE
	CK_t(n-1)	CK_t(n)	CS_N	CA0	CA1	CA2	CA3	CA4	CA5	CA6	CA7	CA8	CA9	
MRW	H	H	L	L	L	L	L	MA0	MA1	MA2	MA3	MA4	MA5	
			X	MA6	MA7	OP0	OP1	OP2	OP3	OP4	OP5	OP6	OP7	
MRR	H	H	L	L	L	L	H	MA0	MA1	MA2	MA3	MA4	MA5	
			X	MA6	MA7	X								
Refresh (per bank)	H	H	L	L	L	H	L	X						
			X	X										
Refresh (all bank)	H	H	L	L	L	H	H	X						
			X	X										
Enter Self Refresh	H	L	L	L	L	H	X							
	X		X	X										
Activate (bank)	H	H	L	L	H	R8	R9	R10	R11	R12	BA0	BA1	BA2	
			X	R0	R1	R2	R3	R4	R5	R6	R7	R13	R14	
Write (bank)	H	H	L	H	L	L	RFU	RFU	C1	C2	BA0	BA1	BA2	
			X	AP ³	C3	C4	C5	C6	C7	C8	C9	C10	C11	
Read (bank)	H	H	L	H	L	H	RFU	RFU	C1	C2	BA0	BA1	BA2	
			X	AP ³	C3	C4	C5	C6	C7	C8	C9	C10	C11	
Precharge 11 (per bank, all bank)	H	H	L	H	H	L	H	AB	X	X	BA0	BA1	BA2	
			X	X	X	X	X	X	X	X	X	X	X	
Enter Deep Power Down	H	L	L	H	H	L	X							
	X		X	X										

NOP	H	H	L	H	H	H	X	
			X	X				
Maintain PD, SREF, DPD (NOP) see note 4	L	L	L	H	H	H	X	
			X	X				
NOP	H	H	H	X				
			X	X				
Maintain PD, SREF, DPD see note 4	L	L	X	X				
			X	X				
Enter Power Down	H	L	H	X				
	X		X	X				
Exit PD, SREF, DPD	L	H	H	X				
	X		X	X				

Note:

- All LPDDR3 commands are defined by states of CS_n, CA0, CA1, CA2, CA3, and CKE at the rising edge of the clock.
- Bank addresses BA0, BA1, BA2 (BA) determine which bank is to be operated upon.
- AP “high” during a READ or WRITE command indicates that an auto-precharge will occur to the bank associated with the READ or WRITE command.
- “X” means “H or L (but a defined logic level)”, except when the LPDDR3 SDRAM is in PD, SREF, or DPD, in which case CS_n, CK_t/CK_c, and CA can be floated after the required t_{CPDED} time is satisfied, and until the required exit procedure is initiated as described in the respective entry/exit procedure. See also Self-Refresh Operation figure, Basic Power-Down Entry and Exit Timing figure and Deep power down entry and exit timing diagram figure.
- Self refresh exit and Deep Power Down exit are asynchronous.
- V_{REF} must be between 0 and V_{DDQ} during Self Refresh and Deep Power Down operation.
- CA_{xr} refers to command/address bit “x” on the rising edge of clock.
- CA_{xf} refers to command/address bit “x” on the falling edge of clock.
- CS_n and CKE are sampled at the rising edge of clock.
- The least-significant column address C0 is not transmitted on the CA bus, and is implied to be zero.
- AB “high” during Precharge command indicates that all bank Precharge will occur. In this case, Bank Address is do-not-care.
- When CS_n is HIGH, LPDDR3 CA bus can be floated.

CKE Table^{1,2}

Device Current State ³	CKEn-1 ⁴	CKEn ⁴	CS _n ⁵	Command n ⁶	Operation n ⁶	Device Next State	Notes
Active Power Down	L	L	X	X	Maintain Active Power Down	Active Power Down	
	L	H	H	NOP	Exit Active Power Down	Active	7
Idle Power Down	L	L	X	X	Maintain Idle Power Down	Idle Power Down	
	L	H	H	NOP	Exit Idle Power Down	Idle	7
Resetting Power Down	L	L	X	X	Maintain Resetting Power Down	Resetting Power Down	
	L	H	H	NOP	Exit Resetting Power Down	Idle or Resetting	7, 10
Deep Power Down	L	L	X	X	Maintain Deep Power Down	Deep Power Down	
	L	H	H	NOP	Exit Deep Power Down	Power On	9
Self Refresh	L	L	X	X	Maintain Self Refresh	Self Refresh	
	L	H	H	NOP	Exit Self Refresh	Idle	8
Bank(s) Active	H	L	H	NOP	Enter Active Power Down	Active Power Down	
All Banks Idle	H	L	H	NOP	Enter Idle Power Down	Idle Power Down	11
	H	L	L	Enter Self-Refresh	Enter Self Refresh	Self Refresh	
	H	L	L	Enter Deep Power Down	Enter Deep Power Down	Deep Power Down	
Resetting	H	L	H	NOP	Enter Resetting Power Down	Resetting Power Down	
	H	H	Refer to the Command Truth Table				

Note:

- All states and sequences not shown are illegal or reserved unless explicitly described elsewhere in this document.
- 'X' means 'Don't care'.
- "Current state" is the state of the LPDDR3 device immediately prior to clock edge n.
- "CKEn" is the logic state of CKE at clock rising edge n; "CKEn-1" was the state of CKE at the previous clock edge.
- "CS_n" is the logic state of CS_n at the clock rising edge n;
- "Command n" is the command registered at clock edge N, and "Operation n" is a result of "Command n".
- Power Down exit time (t_{XP}) should elapse before a command other than NOP is issued. The clock must toggle at least twice during the t_{XP} period.
- Self-Refresh exit time (t_{XS_R}) should elapse before a command other than NOP is issued. The clock must toggle at least twice during the t_{XS_R} time.
- The Deep Power-Down exit procedure must be followed as discussed in the Deep Power-Down section of the Functional Description.
- Upon exiting Resetting Power Down, the device will return to the Idle state if t_{INIT5} has expired.
- In the case of ODT disabled, all DQ output shall be Hi-Z. In the case of ODT enabled, all DQ shall be terminated to V_{DDQ}.

State Truth Tables

The truth tables provide complementary information to the state diagram, they clarify the device behavior and the applied restrictions when considering the actual state of all banks.

Current State	Command	Operation	Next State	NOTES
Any	NOP	Continue previous operation	Current State	
Idle	ACTIVATE	Select and activate row	Active	
	Refresh (Per Bank)	Begin to refresh	Refreshing (Per Bank)	6
	Refresh (All Bank)	Begin to refresh	Refreshing(All Bank)	7
	MRW	Write value to Mode Register	MR Writing	7
	MRR	Read value from Mode Register	Idle MR Reading	
	Reset	Begin Device Auto-Initialization	Resetting	8
	Precharge	Deactivate row in bank or banks	Precharging	9, 14
Row Active	Read	Select column, and start read burst	Reading	11
	Write	Select column, and start write burst	Writing	11
	MRR	Read value from Mode Register	Active MR Reading	
	Precharge	Deactivate row in bank or banks	Precharging	9
Reading	Read	Select column, and start new read burst	Reading	10, 11
	Write	Select column, and start write burst	Writing	10, 11, 12
Writing	Write	Select column, and start new write burst	Writing	10, 11
	Read	Select column, and start read burst	Reading	10, 11, 13
Power On	Reset	Begin Device Auto-Initialization	Resetting	8
Resetting	MRR	Read value from Mode Register	Resetting MR Reading	

Note:

- The table applies when both CKEn-1 and CKEn are HIGH, and after t_{XSR} or t_{XP} has been met if the previous state was Power Down.
- All states and sequences not shown are illegal or reserved.
- Current State Definitions:
 - Idle: The bank or banks have been precharged, and t_{RP} has been met.
 - Active: A row in the bank has been activated, and t_{RCD} has been met. No data bursts / accesses and no register accesses are in progress.
 - Reading: A Read burst has been initiated, with Auto Precharge disabled.
 - Writing: A Write burst has been initiated, with Auto Precharge disabled.

4. The following states must not be interrupted by a command issued to the same bank. NOP commands or allowable commands to the other bank should be issued on any clock edge occurring during these states. Allowable commands to the other banks are determined by its current state and Pad Definition and Description table, and according to Functional Description table.
 - Precharging: starts with the registration of a Precharge command and ends when t_{RP} is met. Once t_{RP} is met, the bank will be in the idle state.
 - Row Activating: starts with registration of an Activate command and ends when t_{RCD} is met. Once t_{RCD} is met, the bank will be in the 'Active' state.
 - Read with AP Enabled: starts with the registration of the Read command with Auto Precharge enabled and ends when t_{RP} has been met. Once t_{RP} has been met, the bank will be in the idle state.
 - Write with AP Enabled: starts with registration of a Write command with Auto Precharge enabled and ends when t_{RP} has been met. Once t_{RP} is met, the bank will be in the idle state.
5. The following states must not be interrupted by any executable command; NOP commands must be applied to each positive clock edge during these states.
 - Refreshing (Per Bank): starts with registration of a Refresh (Per Bank) command and ends when t_{RFCpb} is met. Once t_{RFCpb} is met, the bank will be in an 'idle' state.
 - Refreshing (All Bank): starts with registration of an Refresh (All Bank) command and ends when t_{RFCab} is met. Once t_{RFCab} is met, the device will be in an 'all banks idle' state.
 - Idle MR Reading: starts with the registration of an MRR command and ends when t_{MRR} has been met. Once t_{MRR} has been met, the bank will be in the Idle state.
 - Resetting MR Reading: starts with the registration of an MRR command and ends when t_{MRR} has been met. Once t_{MRR} has been met, the bank will be in the Resetting state.
 - Active MR Reading: starts with the registration of an MRR command and ends when t_{MRR} has been met. Once t_{MRR} has been met, the bank will be in the Active state.
 - MR Writing: starts with the registration of an MRW command and ends when t_{MRW} has been met. Once t_{MRW} has been met, the bank will be in the Idle state.
 - Precharging All: starts with the registration of a Precharge-All command and ends when t_{RP} is met. Once t_{RP} is met, the bank will be in the idle state.
6. Bank-specific; requires that the bank is idle and no bursts are in progress.
7. Not bank-specific; requires that all banks are idle and no bursts are in progress.
8. Not bank-specific reset command is achieved through Mode Register Write command.
9. This command may or may not be bank specific. If all banks are being precharged, they must be in a valid state for precharging.
10. A command other than NOP should not be issued to the same bank while a Read or Write burst with Auto Precharge is enabled.
11. The new Read or Write command could be Auto Precharge enabled or Auto Precharge disabled.
12. A Write command may be applied after the completion of the Read burst, burst terminates are not permitted.
13. A Read command may be applied after the completion of the Write burst, burst terminates are not permitted.
14. If a Precharge command is issued to a bank in the Idle state, t_{RP} shall still apply.

Current State Bank *n* - Command to Bank *m*

Current State of Bank <i>n</i>	Command for Bank <i>m</i>	Operation	Next State for Bank <i>m</i>	NOTES
Any	NOP	Continue previous operation	Current State of Bank <i>m</i>	
Idle	Any	Any command allowed to Bank <i>m</i>	-	18
Row Activating, Active, or Precharging	Activate	Select and activate row in Bank <i>m</i>	Active	6
	Read	Select column, and start read burst from Bank <i>m</i>	Reading	7
	Write	Select column, and start write burst to Bank <i>m</i>	Writing	7
	Precharge	Deactivate row in bank or banks	Precharging	8
	MRR	Read value from Mode Register	Idle MR Reading or Active MR Reading	9, 10, 12
Reading (Autoprecharge disabled)	Read	Select column, and start read burst from Bank <i>m</i>	Reading	7
	Write	Select column, and start write burst to Bank <i>m</i>	Writing	7, 13
	Activate	Select and activate row in Bank <i>m</i>	Active	
	Precharge	Deactivate row in bank or banks	Precharging	8
Writing (Autoprecharge disabled)	Read	Select column, and start read burst from Bank <i>m</i>	Reading	7, 15
	Write	Select column, and start write burst to Bank <i>m</i>	Writing	7
	Activate	Select and activate row in Bank <i>m</i>	Active	
	Precharge	Deactivate row in bank or banks	Precharging	8
Reading with Autoprecharge	Read	Select column, and start read burst from Bank <i>m</i>	Reading	7, 14
	Write	Select column, and start write burst to Bank <i>m</i>	Writing	7, 13, 14
	Activate	Select and activate row in Bank <i>m</i>	Active	
	Precharge	Deactivate row in bank or banks	Precharging	8
Writing with Autoprecharge	Read	Select column, and start read burst from Bank <i>m</i>	Reading	7, 14, 15
	Write	Select column, and start write burst to Bank <i>m</i>	Writing	7, 14
	Activate	Select and activate row in Bank <i>m</i>	Active	
	Precharge	Deactivate row in bank or banks	Precharging	8
Power On	Reset	Begin Device Auto-Initialization	Resetting	11, 16
Resetting	MRR	Read value from Mode Register	Resetting MR Reading	

Note:

- The table applies when both CKEn-1 and CKEn are HIGH, and after t_{XSR} or t_{XP} has been met if the previous state was Self Refresh or Power Down.
- All states and sequences not shown are illegal or reserved.
- Current State Definitions:
 Idle: the bank has been precharged, and t_{RP} has been met.
 Active: a row in the bank has been activated, and t_{RCD} has been met. No data bursts/accesses and no register accesses are in progress.
 Reading: a Read burst has been initiated, with Auto Precharge disabled.
 Writing: a Write burst has been initiated, with Auto Precharge disabled.
- Refresh, Self-Refresh, and Mode Register Write commands may only be issued when all bank are idle.

5. The following states must not be interrupted by any executable command; NOP commands must be applied during each clock cycle while in these states:
 - Idle MR Reading: starts with the registration of an MRR command and ends when t_{MRR} has been met. Once t_{MRR} has been met, the bank will be in the Idle state.
 - Resetting MR Reading: starts with the registration of an MRR command and ends when t_{MRR} has been met. Once t_{MRR} has been met, the bank will be in the Resetting state.
 - Active MR Reading: starts with the registration of an MRR command and ends when t_{MRR} has been met. Once t_{MRR} has been met, the bank will be in the Active state.
 - MR Writing: starts with the registration of an MRW command and ends when t_{MRW} has been met. Once t_{MRW} has been met, the bank will be in the Idle state.
6. t_{RRD} must be met between Activate command to Bank n and a subsequent Activate command to Bank m . Additionally, in the case of multiple banks activated, t_{FAW} must be satisfied.
7. Reads or Writes listed in the Command column include Reads and Writes with Auto Precharge enabled and Reads and Writes with Auto Precharge disabled.
8. This command may or may not be bank specific. If all banks are being precharged, they must be in a valid state for precharging.
9. MRR is allowed during the Row Activating state (Row Activating starts with registration of an Activate command and ends when t_{RCD} is met.)
10. MRR is allowed during the Precharging state. (Precharging starts with registration of a Precharge command and ends when t_{RP} is met.)
11. Not bank-specific; requires that all banks are idle and no bursts are in progress.
12. The next state for Bank m depends on the current state of Bank m (Idle, Row Activating, Precharging, or Active). The reader shall note that the state may be in transition when an MRR is issued. Therefore, if Bank m is in the Row Activating state and Precharging, the next state may be Active and Precharge dependent upon t_{RCD} and t_{RP} respectively.
13. A Write command may be applied after the completion of the Read burst, burst terminates are not permitted..
14. Read with auto precharge enabled or a Write with auto precharge enabled may be followed by any valid command to other banks provided that the timing restrictions described in the precharge and auto-precharge clarification table are followed.
15. A Read command may be applied after the completion of the Write burst, burst terminates are not permitted.
16. Reset command is achieved through Mode Register Write command.

Data Mask Truth Table

DM truth table

Name (Functional)	DM	DQs	Note
Write enable	L	Valid	1
Write inhibit	H	X	1

Note: 1. Used to mask write data, provided coincident with the corresponding data.

Absolute Maximum Ratings

Absolute Maximum DC Ratings

Stresses greater than those listed may cause permanent damage to the device. This is a stress rating only, and functional operation of the device at these or any other conditions above those indicated in the operational sections of this specification is not implied. Exposure to absolute maximum rating conditions for extended periods may affect reliability.

Absolute Maximum DC Ratings

Parameter	Symbol	Min	Max	Units	Notes
V _{DD1} supply voltage relative to V _{SS}	V _{DD1}	-0.4	2.3	V	1
V _{DD2} supply voltage relative to V _{SS}	V _{DD2}	-0.4	1.6	V	1
V _{DDCA} supply voltage relative to V _{SSCA}	V _{DDCA}	-0.4	1.6	V	1,2
V _{DDQ} supply voltage relative to V _{SSQ}	V _{DDQ}	-0.4	1.6	V	1,3
Voltage on any ball relative to V _{SS}	V _{IN} , V _{OUT}	-0.4	1.6	V	
Storage Temperature	T _{STG}	-55	125	°C	4

Note:

1. See "Power-Ramp" section in "Power-up, Initialization, and Power-off" for relationships between power supplies.
2. V_{REFCA} 0.6 x V_{DDCA}; however, V_{REFCA} may be V_{DDCA} provided that V_{REFCA} 300mV.
3. V_{REFDQ} 0.7 x V_{DDQ}; however, V_{REFDQ} may be V_{DDQ} provided that V_{REFDQ} 300mV.
4. Storage Temperature is the case surface temperature on the center/top side of the LPDDR3 device. For the measurement conditions, please refer to JE51-2 standard.

AC & DC Operating Conditions

Operation or timing that is not specified is illegal, and after such an event, in order to guarantee proper operation, the LPDDR3 device must be powered down and then restarted through the specialized initialization sequence before normal operation can continue.

Recommended DC Operating Conditions

Symbol	Voltage			DRAM	Unit
	Min	Typ	Max		
V _{DD1}	1.70	1.80	1.95	Core Power1	V
V _{DD2}	1.14	1.20	1.30	Core Power2	V
V _{DDCA}	1.14	1.20	1.30	Input Buffer Power	V
V _{DDQ}	1.14	1.20	1.30	I/O Buffer Power	V

Note:

- V_{DD1} uses significantly less current than V_{DD2}.
- The voltage range is for DC voltage only. DC is defined as the voltage supplied at the DRAM and is inclusive of all noise up to 1MHz at the DRAM package ball.

Input Leakage Current

Parameter/Condition	Symbol	Min	Max	Unit	Notes
Input Leakage current	I _L	-2	2	uA	1, 2
V _{REF} supply leakage current	I _{VREF}	-1	1	uA	3, 4

Note:

- For CA, CKE, CS_n, CK_t, CK_c. Any input $0V \leq V_{IN} \leq V_{DDCA}$ (All other pins not under test = 0V)
- Although DM is for input only, the DM leakage shall match the DQ and DQS_t/DQS_c output leakage specification. The minimum limit requirement is for testing purposes. The leakage current on V_{REFCA} and V_{REFDQ} pins should be minimal.
- V_{REFDQ} = V_{DDQ}/2 or V_{REFCA} = V_{DDCA}/2. (All other pins not under test = 0V)

Operating Temperature Range

Parameter/Condition	Symbol	Min	Max	Unit
Standard	T _{OPER}	-25	85	°C
Elevated		85	95	°C

Note:

- Operating Temperature is the case surface temperature on the center-top side of the LPDDR3 device. For the measurement conditions, please refer to JESD51-2 standard.
- Either the device case temperature rating or the temperature sensor (See "Temperature Sensor") may be used to set an appropriate refresh rate, determine the need for AC timing de-rating and/or monitor the operating temperature. When using the temperature sensor, the actual device case temperature may be higher than the T_{OPER} rating that applies for the Standard or Elevated Temperature Ranges. For example, T_{CASE} may be above 85°C when the temperature sensor indicates a temperature of less than 85°C.

AC and DC Input Measurement Levels

AC and DC Logic Input Levels for Single-Ended Signals

Single-Ended AC and DC Input Levels for CA and CS_n Inputs

Symbol	Parameter	1600		1866/2133		Unit	Notes
		Min	Max	Min	Max		
V _{IHCA(AC)}	AC input logic high	V _{Ref} + 0.150	Note 2	V _{Ref} + 0.135	Note 2	V	1, 2
V _{ILCA(AC)}	AC input logic low	Note 2	V _{Ref} - 0.150	Note 2	V _{Ref} - 0.135	V	1, 2
V _{IHCA(DC)}	DC input logic high	V _{Ref} + 0.100	V _{DDCA}	V _{Ref} + 0.100	V _{DDCA}	V	1
V _{ILCA(DC)}	DC input logic low	V _{SSCA}	V _{Ref} - 0.100	V _{SSCA}	V _{Ref} - 0.100	V	1
V _{RefCA(DC)}	Reference Voltage for CA and CS_n inputs	0.49 * V _{DDCA}	0.51 * V _{DDCA}	0.49 * V _{DDCA}	0.51 * V _{DDCA}	V	3, 4

Note:

1. For CA and CS_n input only pins. V_{Ref} = V_{RefCA(DC)}.
2. See "Overshoot and Undershoot Specifications"
3. The ac peak noise on V_{RefCA} may not allow V_{RefCA} to deviate from V_{RefCA(DC)} by more than +/-1% V_{DDCA} (for reference: approx. +/- 12 mV).
4. For reference: approx. V_{DDCA}/2 +/- 12 mV.

Single-Ended AC and DC Input Levels for CKE

Symbol	Parameter	Min	Max	Unit	Notes
V _{IHCKE}	CKE Input High Level	0.65 * V _{DDCA}	Note 1	V	1
V _{ILCKE}	CKE Input Low Level	Note 1	0.35 * V _{DDCA}	V	1

Note: 1. See "Overshoot and Undershoot Specifications"

AC and DC Input Levels for Single-Ended Data Signals

Single-Ended AC and DC Input Levels for DQ and DM

Symbol	Parameter	1600		1866/2133		Unit	Notes
		Min	Max	Min	Max		
V _{IHDQ(AC)}	AC input logic high	V _{Ref} + 0.150	Note 2	V _{Ref} + 0.135	Note 2	V	1, 2, 5
V _{ILDQ(AC)}	AC input logic low	Note 2	V _{Ref} - 0.150	Note 2	V _{Ref} - 0.135	V	1, 2, 5
V _{IHDQ(DC)}	DC input logic high	V _{Ref} + 0.100	V _{DDQ}	V _{Ref} + 0.100	V _{DDQ}	V	1
V _{ILDQ(DC)}	DC input logic low	V _{SSQ}	V _{Ref} - 0.100	V _{SSQ}	V _{Ref} - 0.100	V	1
V _{RefDQ(DC)} (DQ ODT disabled)	Reference Voltage for DQ, DM inputs	0.49 * V _{DDQ}	0.51 * V _{DDQ}	0.49 * V _{DDQ}	0.51 * V _{DDQ}	V	3, 4
V _{RefDQ(DC)} (DQ ODT enabled)	Reference Voltage for DQ, DM inputs	V _{ODTR} /2 - 0.01 * V _{DDQ}	V _{ODTR} /2 + 0.01 * V _{DDQ}	V _{ODTR} /2 - 0.01 * V _{DDQ}	V _{ODTR} /2 + 0.01 * V _{DDQ}	V	3, 5, 6

Note:

- For DQ input only pins. V_{Ref} = V_{RefDQ(DC)}.
- See "Overshoot and Undershoot Specifications"
- The ac peak noise on V_{RefDQ} may not allow V_{RefDQ} to deviate from V_{RefDQ(DC)} by more than +/-1% V_{DDQ} (for reference: approx. +/- 12 mV).
- For reference: approx. V_{DDQ}/2 +/- 12 mV.
- For reference: approx. V_{ODTR}/2 +/- 12 mV.
- The nominal mode register programmed value for R_{ODT} and the nominal controller output impedance R_{ON} are used for the calculation of V_{ODTR}. For testing purposes a controller R_{ON} value of 50Ω is used.

$$V_{ODTR} = \frac{2R_{ON} + R_{TT}}{R_{ON} + R_{TT}} \times V_{DDQ}$$

Vref Tolerances

The dc-tolerance limits and ac-noise limits for the reference voltages V_{RefCA} and V_{RefDQ} are illustrated in Illustration of $V_{Ref(DC)}$ tolerance and V_{Ref} ac-noise limits figure.

It shows a valid reference voltage $V_{Ref(t)}$ as a function of time. (V_{Ref} stands for V_{RefCA} and V_{RefDQ} likewise). V_{DD} stands for V_{DDCA} for V_{RefCA} and V_{DDQ} for V_{RefDQ} . $V_{Ref(DC)}$ is the linear average of $V_{Ref(t)}$ over a very long period of time (e.g. 1 sec) and is specified as a fraction of the linear average of V_{DDQ} or V_{DDCA} also over a very long period of time (e.g. 1 sec). This average has to meet the min/max requirements in Single-Ended AC and DC Input Levels for CA and CS_n Inputs table. Furthermore $V_{Ref(t)}$ may temporarily deviate from $V_{Ref(DC)}$ by no more than +/- 1% V_{DD} . $V_{Ref(t)}$ cannot track noise on V_{DDQ} or V_{DDCA} if this would send V_{Ref} outside these specifications.

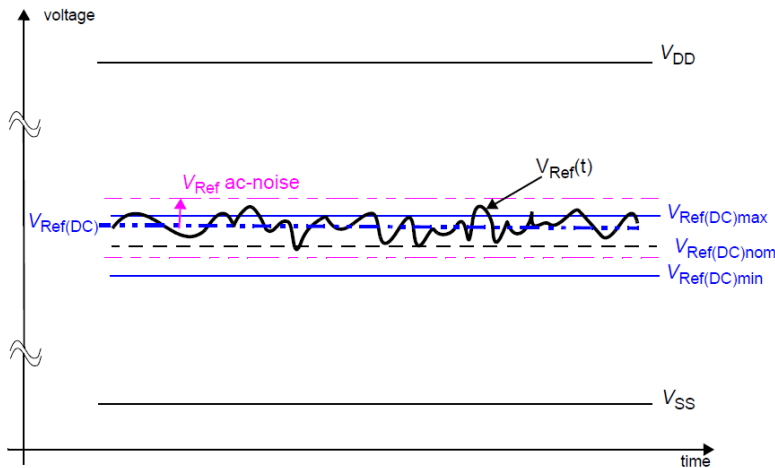
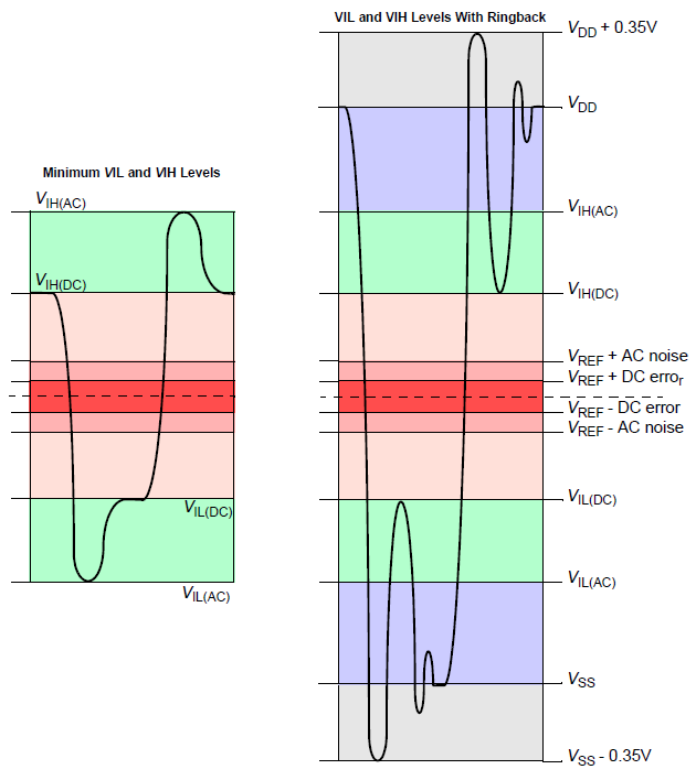

Illustration of $V_{Ref(DC)}$ tolerance and V_{Ref} ac-noise limits

The voltage levels for setup and hold time measurements $V_{IH(AC)}$, $V_{IH(DC)}$, $V_{IL(AC)}$ and $V_{IL(DC)}$ are dependent on V_{Ref} . “ V_{Ref} ” shall be understood as $V_{Ref(DC)}$, as defined in Illustration of $V_{Ref(DC)}$ tolerance and V_{Ref} ac-noise limits figure.

This clarifies that dc-variations of V_{Ref} affect the absolute voltage a signal has to reach to achieve a valid high or low level and therefore the time to which setup and hold is measured. System timing and voltage budgets need to account for $V_{REF(DC)}$ deviations from the optimum position within the data-eye of the input signals.

This also clarifies that the LPDDR3 setup/hold specification and derating values need to include time and voltage associated with V_{Ref} ac-noise. Timing and voltage effects due to ac-noise on V_{Ref} up to the specified limit (+/-1% of V_{DD}) are included in LPDDR3 timings and their associated deratings.



Input Signal

Note:

1. Numbers reflect nominal values.
2. For CA0-9, CK_t, CK_c, and CS_n, V_{DD} stands for V_{DDCA} . For DQ, DM, DQS_t, and DQS_c, V_{DD} stands for V_{DDQ} .
3. For CA0-9, CK_t, CK_c, and CS_n, V_{SS} stands for V_{SSCA} . For DQ, DM, DQS_t, and DQS_c, V_{SS} stand for V_{SSQ} .

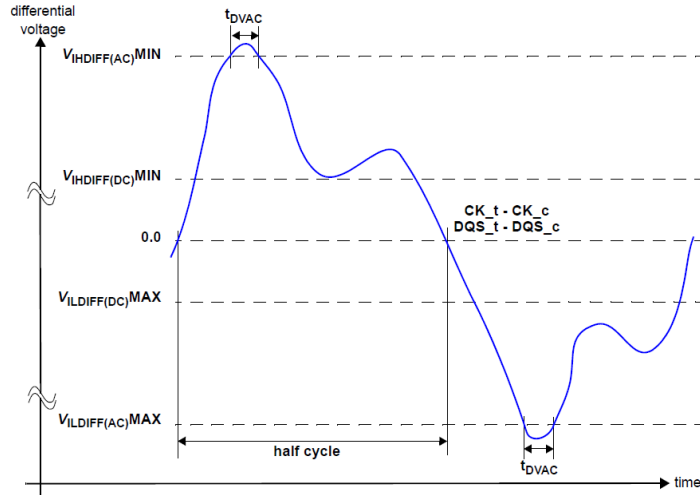
AC and DC Logic Input Levels for Differential Signals**Differential signal definition****Definition of differential ac-swing and “time above ac-level” t_{DVAC}**

Differential swing requirements for clock (CK_t - CK_c) and strobe (DQS_t - DQS_c)

Differential AC and DC Input Levels

Symbol	Parameter	Value		Unit	Notes
		Min	Max		
V _{IHdiff(dc)}	Differential input high	2 x (V _{IH(dc)} - V _{Ref})	note 3	V	1
V _{ILdiff(dc)}	Differential input low	Note 3	2 x (V _{IL(dc)} - V _{Ref})	V	1
V _{IHdiff(ac)}	Differential input high ac	2 x (V _{IH(ac)} - V _{Ref})	Note 3	V	2
V _{ILdiff(ac)}	Differential input low ac	note 3	2 x (V _{IL(ac)} - V _{Ref})	V	2

Note:

- Used to define a differential signal slew-rate. For CK_t - CK_c use V_{IH}/V_{IL(dc)} of CA and V_{REFCA}; for DQS_t - DQS_c, use V_{IH}/V_{IL(dc)} of DQs and V_{REFDQ}; if a reduced dc-high or dc-low level is used for a signal group, then the reduced level applies also here.
- For CK_t - CK_c use V_{IH}/V_{IL(ac)} of CA and V_{REFCA}; for DQS_t - DQS_c, use V_{IH}/V_{IL(ac)} of DQs and V_{REFDQ}; if a reduced ac-high or ac-low level is used for a signal group, then the reduced level applies also here.
- These values are not defined, however the single-ended signals CK_t, CK_c, DQS_t, and DQS_c need to be within the respective limits (V_{IH(dc) max}, V_{IL(dc) min}) for single-ended signals as well as the limitations for overshoot and undershoot. Refer to.
- For CK_t and CK_c, V_{Ref} = V_{RefCA(DC)}. For DQS_t and DQS_c, V_{Ref} = V_{RefDQ(DC)}.

Allowed time before ringback t_{DVAC} for DQS_t/DQS_c

Slew Rate [V/ns]	t_{DVAC} [ps] @ $ V_{IH}/L_{diff(ac)} = 300mV$ 1600Mbps		t_{DVAC} [ps] @ $ V_{IH}/L_{diff(ac)} = 270mV$ 1866Mbps		t_{DVAC} [ps] @ $ V_{IH}/L_{diff(ac)} = 270mV$ 2133Mbps	
	min	max	min	max	min	max
> 8.0	48	-	40	-	34	-
8.0	48	-	40	-	34	-
7.0	46	-	39	-	33	-
6.0	43	-	36	-	30	-
5.0	40	-	33	-	27	-
4.0	35	-	29	-	23	-
3.0	27	-	21	-	15	-
< 3.0	27	-	21	-	15	-

Allowed time before ringback t_{DVAC} for CK_t/CK_c

Slew Rate [V/ns]	t_{DVAC} [ps] @ $ V_{IH}/L_{diff(ac)} = 300mV$ 1600Mbps		t_{DVAC} [ps] @ $ V_{IH}/L_{diff(ac)} = 270mV$ 1866Mbps		t_{DVAC} [ps] @ $ V_{IH}/L_{diff(ac)} = 270mV$ 2133Mbps	
	min	max	min	max	min	max
> 8.0	48	-	40	-	34	-
8.0	48	-	40	-	34	-
7.0	46	-	39	-	33	-
6.0	43	-	36	-	30	-
5.0	40	-	33	-	27	-
4.0	35	-	29	-	23	-
3.0	27	-	21	-	15	-
< 3.0	27	-	21	-	15	-

Single-ended requirements for differential signals

Each individual component of a differential signal (CK_t, DQS_t, CK_c, or DQS_c) has also to comply with certain requirements for single-ended signals.

CK_t and CK_c shall meet $V_{SEH(ac)min} / V_{SEL(ac)max}$ in every half-cycle.

DQS_t, DQS_c shall meet $V_{SEH(ac)min} / V_{SEL(ac)max}$ in every half-cycle preceding and following a valid transition.

Note that the applicable ac-levels for CA and DQ's are different per speed-bin.

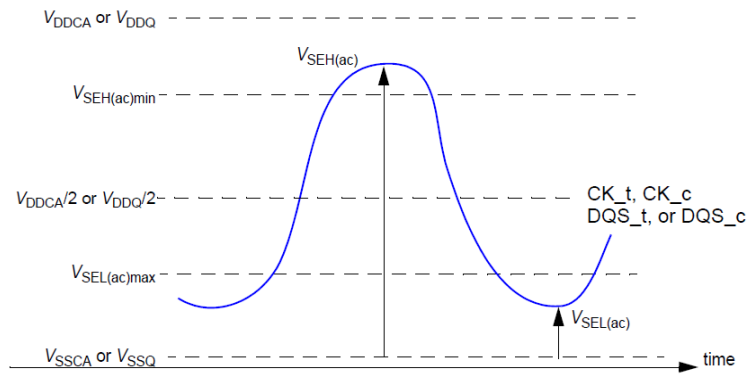

Single-ended requirement for differential signals

Note that while CA and DQ signal requirements are with respect to Vref, the single-ended components of differential signals have a requirement with respect to $V_{DDQ}/2$ for DQS_t, DQS_c and $V_{DDCA}/2$ for CK_t, CK_c; this is nominally the same. The transition of single-ended signals through the ac-levels is used to measure setup time. For single-ended components of differential signals the requirement to reach $V_{SEL(ac)max}$, $V_{SEH(ac)min}$ has no bearing on timing, but adds a restriction on the common mode characteristics of these signals.

The signal ended requirements for CK_t, CK_c, DQS_t, and DQS_c are found in Single-Ended AC and DC Input Levels for CA and CS_n Inputs table and Single-Ended AC and DC Input Levels for DQ and DM table, respectively.

Single-ended levels for CK_t, DQS_t, CK_c, DQS_c

Symbol	Parameter	Value		Unit	Notes
		Min	Max		
V _{SEH(AC150)}	Single-ended high-level for strobes	$(V_{DDQ} / 2) + 0.150$	note 3	V	1, 2
	Single-ended high-level for CK_t, CK_c	$(V_{DDCA} / 2) + 0.150$	note 3	V	1, 2
V _{SEL(AC150)}	Single-ended low-level for strobes	note 3	$(V_{DDQ} / 2) - 0.150$	V	1, 2
	Single-ended low-level for CK_t, CK_c	note 3	$(V_{DDCA} / 2) - 0.150$	V	1, 2
V _{SEH(AC135)}	Single-ended high-level for strobes	$(V_{DDQ} / 2) + 0.135$	note 3	V	1, 2
	Single-ended high-level for CK_t, CK_c	$(V_{DDCA} / 2) + 0.135$	note 3	V	1, 2
V _{SEL(AC135)}	Single-ended low-level for strobes	note 3	$(V_{DDQ} / 2) - 0.135$	V	1, 2
	Single-ended low-level for CK_t, CK_c	note 3	$(V_{DDCA} / 2) - 0.135$	V	1, 2

Note:

1. For CK_t, CK_c use V_{SEH}/V_{SEL(ac)} of CA; for strobes (DQS0_t, DQS0_c, DQS1_t, DQS1_c) use V_{IH}/V_{IL(ac)} of DQs.
2. V_{IH(ac)}/V_{IL(ac)} for DQs is based on V_{REFDQ}; V_{SEH(ac)}/V_{SEL(ac)} for CA is based on V_{REFCA}; if a reduced ac-high or ac-low level is used for a signal group, then the reduced level applies also here
3. These values are not defined, however the single-ended signals CK_t, CK_c, DQS0_t, DQS0_c, DQS1_t, DQS1_c need to be within the respective limits (V_{IH(dc)max}, V_{IL(dc)min}) for single-ended signals as well as the limitations for overshoot and undershoot. Refer to "Overshoot and Undershoot Specifications".

Differential Input Cross Point Voltage

To guarantee tight setup and hold times as well as output skew parameters with respect to clock and strobe, each cross point voltage of differential input signals (CK_t, CK_c and DQS_t, DQS_c) must meet the requirements in Single-ended levels for CK_t, DQS_t, CK_c, DQS_c table.

The differential input cross point voltage V_{IX} is measured from the actual cross point of true and complement signals to the midlevel between of V_{DD} and V_{SS} .

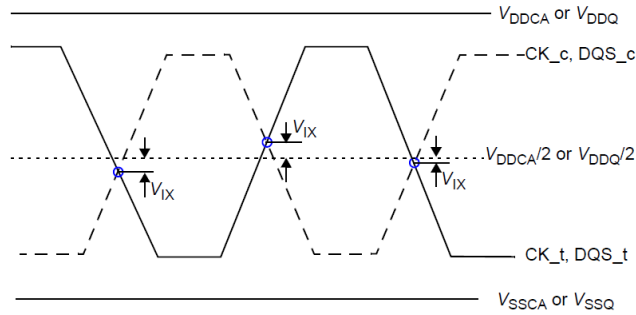

VIX Definition

Cross point voltage for differential input signals (CK, DQS)

Symbol	Parameter	Value		Unit	Notes
		Min	Max		
V_{IXCA}	Differential Input Cross Point Voltage relative to $V_{DDCA}/2$ for CK_t, CK_c	-120	120	mV	1,2
V_{IXDQ}	Differential Input Cross Point Voltage relative to $V_{DDQ}/2$ for DQS_t, DQS_c	-120	120	mV	1,2

Note:

1. The typical value of $V_{IX(AC)}$ is expected to be about $0.5 \times V_{DD}$ of the transmitting device, and $V_{IX(AC)}$ is expected to track variations in V_{DD} . $V_{IX(AC)}$ indicates the voltage at which differential input signals must cross.
2. For CK_t and CK_c, $V_{Ref} = V_{RefCA(DC)}$. For DQS_t and DQS_c, $V_{Ref} = V_{RefDQ(DC)}$.

Slew Rate Definitions for Single-Ended Input Signals

See “CA and CS_n Setup, Hold and Derating” for single-ended slew rate definitions for address and command signals.
 See “Data Setup, Hold and Slew Rate Derating” for single-ended slew rate definitions for data signals.

Slew Rate Definitions for Differential Input Signals

Input slew rate for differential signals (CK_t, CK_c and DQS_t, DQS_c) are defined and measured as shown in Differential Input Slew Rate Definition table and Differential Input Slew Rate Definition for DQS_t, DQS_c and CK_t, CK_c figure.

Differential Input Slew Rate Definition

Description	Measured		Defined by
	from	to	
Differential input slew rate for rising edge (CK_t - CK_c and DQS_t - DQS_c).	$V_{ILdiffmax}$	$V_{IHdiffmin}$	$[V_{IHdiffmin} - V_{ILdiffmax}] / \Delta TRdiff$
Differential input slew rate for falling edge (CK_t - CK_c and DQS_t - DQS_c).	$V_{IHdiffmin}$	$V_{ILdiffmax}$	$[V_{IHdiffmin} - V_{ILdiffmax}] / \Delta TFdiff$

Note: 1. The differential signal (i.e. CK_t - CK_c and DQS_t - DQS_c) must be linear between these thresholds.

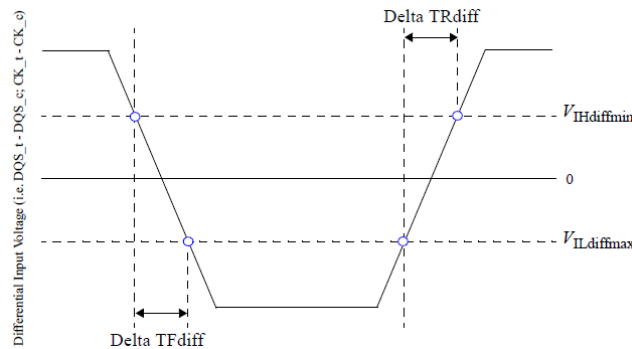

Differential Input Slew Rate Definition for DQS_t, DQS_c and CK_t, CK_c

AC and DC Output Measurement Levels

Single Ended AC and DC Output Levels

Table shows the output levels used for measurements of single ended signals.

Single-ended AC and DC Output Levels

Symbol	Parameter	Value	Unit	Notes
$V_{OH(DC)}$	DC output high measurement level (for IV curve linearity)	$0.9 \times V_{DDQ}$	V	1
$V_{OL(DC)}$ ODT disabled	DC output low measurement level (for IV curve linearity)	$0.1 \times V_{DDQ}$	V	2
$V_{OL(DC)}$ ODT enabled	DC output low measurement level (for IV curve linearity)	$V_{DDQ} \times [0.1 + 0.9 \times (R_{ON} / (R_{TT} + R_{ON}))]$	V	3
$V_{OH(AC)}$	AC output high measurement level (for output slew rate)	$V_{REFDQ} + 0.12$	V	
$V_{OL(AC)}$	AC output low measurement level (for output slew rate)	$V_{REFDQ} - 0.12$	V	
I_{OZ}	Output Leakage current (DQ, DM, DQS_t, DQS_c) (DQ, DQS_t, DQS_c are disabled; $0V \leq V_{OUT} \leq V_{DDQ}$)	Min	-5	uA
		Max	5	uA
M_{MPUPD}	Delta R_{ON} between pull-up and pull-down for DQ/DM	Min	-15	%
		Max	15	%

Note:

- $I_{OH} = -0.1mA$.
- $I_{OL} = 0.1mA$.
- The min value is derived when using $R_{TT, min}$ and $R_{ON, max}$ (+/- 30% uncalibrated, +/-15% calibrated).

Differential AC and DC Output Levels

Table shows the output levels used for measurements of differential signals (DQS_t, DQS_c).

Differential AC and DC Output Levels

Symbol	Parameter	Value	Unit	Notes
$V_{OHdiff(AC)}$	AC differential output high measurement level (for output SR)	$+0.20 \times V_{DDQ}$	V	1
$V_{OLdiff(AC)}$	AC differential output low measurement level (for output SR)	$-0.20 \times V_{DDQ}$	V	2

Note:

- $I_{OH} = -0.1mA$.
- $I_{OL} = 0.1mA$

Single Ended Output Slew Rate

With the reference load for timing measurements, output slew rate for falling and rising edges is defined and measured between $V_{OL(AC)}$ and $V_{OH(AC)}$ for single ended signals as shown in Single-ended Output Slew Rate Definition table and Single Ended Output Slew Rate Definition figure.

Single-ended Output Slew Rate Definition

Description	Measured		Defined by
	from	to	
Single-ended output slew rate for rising edge	$V_{OL(AC)}$	$V_{OH(AC)}$	$[V_{OH(AC)} - V_{OL(AC)}] / \Delta TR_{se}$
Single-ended output slew rate for falling edge	$V_{OH(AC)}$	$V_{OL(AC)}$	$[V_{OH(AC)} - V_{OL(AC)}] / \Delta TF_{se}$

Note: 1. Output slew rate is verified by design and characterization, and may not be subject to production test.

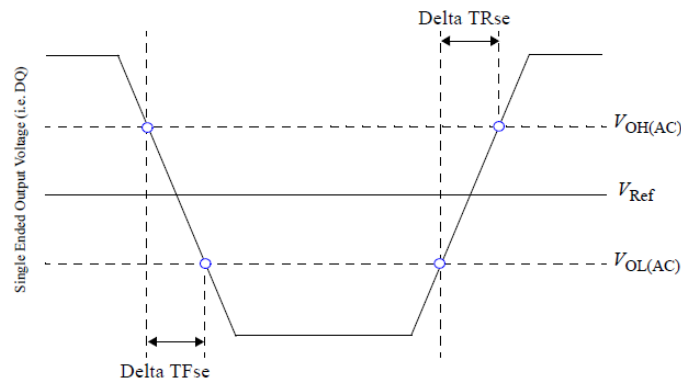

Single Ended Output Slew Rate Definition

Output Slew Rate (single-ended)

Parameter	Symbol	Value		Units
		Min ¹	Max ²	
Single-ended Output Slew Rate (RON = 40Ω +/- 30%)	SRQse	1.5	4.0	V/ns
Output slew-rate matching Ratio (Pull-up to Pull-down)		0.7	1.4	

Description: SR: Slew Rate

Q: Query Output (like in DQ, which stands for Data-in, Query-Output) se: Single-ended Signals

Note:

1. Measured with output reference load.
2. The ratio of pull-up to pull-down slew rate is specified for the same temperature and voltage, over the entire temperature and voltage range. For a given output, it represents the maximum difference between pull-up and pull-down drivers due to process variation.
3. The output slew rate for falling and rising edges is defined and measured between $V_{OL(AC)}$ and $V_{OH(AC)}$.
4. Slew rates are measured under average SSO conditions, with 50% of DQ signals per data byte switching.

Differential Output Slew Rate

With the reference load for timing measurements, output slew rate for falling and rising edges is defined and measured between $V_{OLdiff(AC)}$ and $V_{OHdiff(AC)}$ for differential signals as shown in Differential Output Slew Rate Definition table and Differential Output Slew Rate Definition figure.

Differential Output Slew Rate Definition

Description	Measured		Defined by
	from	to	
Differential output slew rate for rising edge	$V_{OLdiff(AC)}$	$V_{OHdiff(AC)}$	$[V_{OHdiff(AC)} - V_{OLdiff(AC)}] / \Delta TR_{diff}$
Differential output slew rate for falling edge	$V_{OHdiff(AC)}$	$V_{OLdiff(AC)}$	$[V_{OHdiff(AC)} - V_{OLdiff(AC)}] / \Delta TF_{diff}$

Note: 1. Output slew rate is verified by design and characterization, and may not be subject to production test.

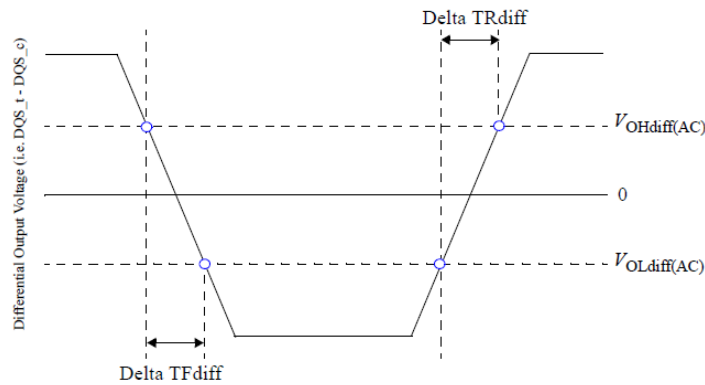

Differential Output Slew Rate Definition

Differential Output Slew Rate

Parameter	Symbol	Value		Units
		Min	Max	
Differential Output Slew Rate ($R_{ON} = 40\Omega \pm 30\%$)	SRQdiff	3.0	8.0	V/ns

Description:
 SR: Slew Rate
 Q: Query Output (like in DQ, which stands for Data-in, Query-Output)
 diff: Differential Signals

Note:

1. Measured with output reference load.
2. The output slew rate for falling and rising edges is defined and measured between $V_{OL(AC)}$ and $V_{OH(AC)}$.
3. Slew rates are measured under average SSO conditions, with 50% of DQ signals per data byte switching.

Overshoot and Undershoot Specifications

AC Overshoot/Undershoot Specification

Parameter		1600	1866	2133	Units
Maximum peak amplitude allowed for overshoot area. (See Overshoot and Undershoot Definition figure)	Max	0.35			V
Maximum peak amplitude allowed for undershoot area. (See Overshoot and Undershoot Definition figure)	Max	0.35			V
Maximum area above V_{DD} . (See Overshoot and Undershoot Definition figure)	Max	0.10	0.10	0.10	V-ns
Maximum area below V_{SS} . (See Overshoot and Undershoot Definition figure)	Max	0.10	0.10	0.10	V-ns

Note:

1. V_{DD} stands for V_{DDCA} for CA[9:0], CK_t, CK_c, CS_n, and CKE. V_{DD} stands for V_{DDQ} for DQ, DM, ODT, DQS_t, and DQS_c.
2. V_{SS} stands for V_{SSCA} for CA[9:0], CK_t, CK_c, CS_n, and CKE. V_{SS} stands for V_{SSQ} for DQ, DM, ODT, DQS_t, and DQS_c.
3. Maximum peak amplitude values are referenced from actual V_{DD} and V_{SS} values.
4. Maximum area values are referenced from maximum operating V_{DD} and V_{SS} values.

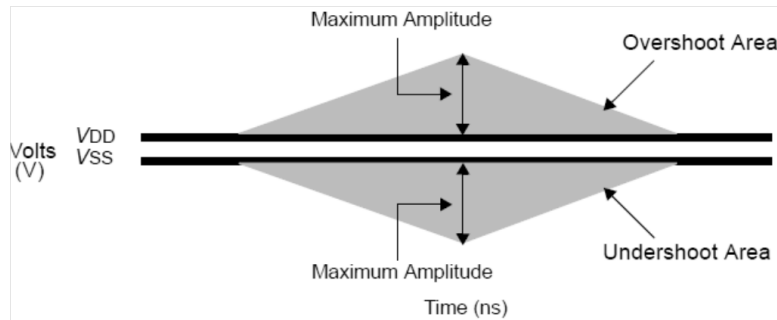

Overshoot and Undershoot Definition

Note:

1. V_{DD} stands for V_{DDCA} for CA[9:0], CK_t, CK_c, CS_n, and CKE. V_{DD} stands for V_{DDQ} for DQ, DM, ODT, DQS_t, and DQS_c.
2. V_{SS} stands for V_{SSCA} for CA[9:0], CK_t, CK_c, CS_n, and CKE. V_{SS} stands for V_{SSQ} for DQ, DM, ODT, DQS_t, and DQS_c.
3. Absolute maximum requirements apply.
4. Maximum peak amplitude values are referenced from actual V_{DD} and V_{SS} values.
5. Maximum area values are referenced from maximum operating V_{DD} and V_{SS} values.

Output buffer characteristics

HSUL_12 Driver Output Timing Reference Load

These 'Timing Reference Loads' are not intended as a precise representation of any particular system environment or a depiction of the actual load presented by a production tester. System designers should use IBIS or other simulation tools to correlate the timing reference load to a system environment. Manufacturers correlate to their production test conditions, generally one or more coaxial transmission lines terminated at the tester electronics.

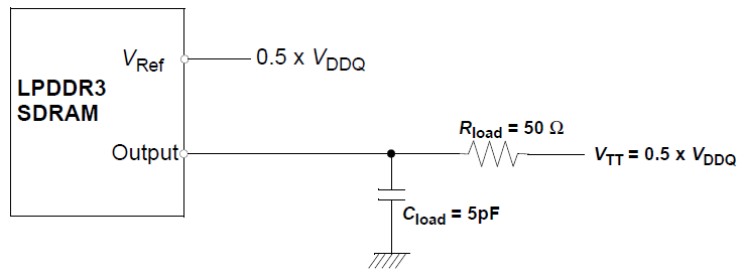

HSUL_12 Driver Output Reference Load for Timing and Slew Rate

Note: 1. All output timing parameter values (like t_{DQSCK} , t_{DQSQ} , t_{QHS} , t_{HZ} , t_{RPRE} etc.) are reported with respect to this reference load. This reference load is also used to report slew rate.

R_{ONPU} and R_{ONPD} Resistor Definition

$$R_{ONPU} = \frac{(V_{DDQ} - V_{out})}{ABS(I_{out})}$$

Note: 1. This is under the condition that R_{ONPD} is turned off

$$R_{ONPD} = \frac{V_{out}}{ABS(I_{out})}$$

Note: 1. This is under the condition that R_{ONPU} is turned off

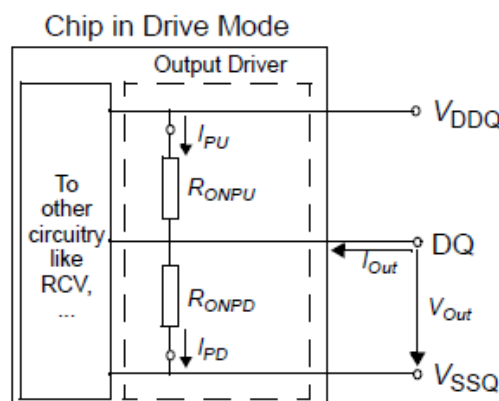

Output Driver: Definition of Voltages and Currents

R_{ONPU} and R_{ONPD} Characteristics with ZQ Calibration

Output driver impedance RON is defined by the value of the external reference resistor R_{ZQ}. Nominal R_{ZQ} is 240Ω.

Output Driver DC Electrical Characteristics with ZQ Calibration

R _{ON,NOM}	Resistor	V _{out}	Min	Nom	Max	Unit	Notes
34.3Ω	R _{ON34PD}	0.5 x V _{DDQ}	0.85	1.00	1.15	R _{ZQ} /7	1,2,3,4
	R _{ON34PU}	0.5 x V _{DDQ}	0.85	1.00	1.15	R _{ZQ} /7	1,2,3,4
40.0Ω	R _{ON40PD}	0.5 x V _{DDQ}	0.85	1.00	1.15	R _{ZQ} /6	1,2,3,4
	R _{ON40PU}	0.5 x V _{DDQ}	0.85	1.00	1.15	R _{ZQ} /6	1,2,3,4
48.0Ω	R _{ON48PD}	0.5 x V _{DDQ}	0.85	1.00	1.15	R _{ZQ} /5	1,2,3,4
	R _{ON48PU}	0.5 x V _{DDQ}	0.85	1.00	1.15	R _{ZQ} /5	1,2,3,4
Mismatch between pull-up and pull-down	M _{MPUPD}		-15.00		+15.00	%	1,2,3,4,5

Note:

1. Across entire operating temperature range, after calibration.
2. R_{ZQ} = 240Ω..
3. The tolerance limits are specified after calibration with fixed voltage and temperature. For behavior of the tolerance limits if temperature or voltage changes after calibration, see following section on voltage and temperature sensitivity.
4. Pull-down and pull-up output driver impedances are recommended to be calibrated at 0.5 x V_{DDQ}.
5. Measurement definition for mismatch between pull-up and pull-down, M_{MPUPD}: Measure R_{ONPU} and R_{ONPD}, both at 0.5 x V_{DDQ}:

$$MM_{PUPD} = \frac{R_{ONPU} - R_{ONPD}}{R_{ONNOM}} \times 100$$

- For example, with MM_{PUPD(max)} = 15% and R_{ONPD} = 0.85, R_{ONPU} must be less than 1.0.
6. Output driver strength measured without ODT.

Output Driver Temperature and Voltage Sensitivity

If temperature and/or voltage change after calibration, the tolerance limits widen according to the Tables shown below.

Output Driver Sensitivity Definition

Resistor	Vout	Min	Max	Unit	Notes
R _{ONPU}	0.5 x V _{DDQ}	$85 - (dR_{ONdT} \times \Delta T) - (dR_{ONdV} \times \Delta V)$	$115 + (dR_{ONdT} \times \Delta T) + (dR_{ONdV} \times \Delta V)$	%	1,2
R _{TT}	0.5 x V _{DDQ}	$85 - (dR_{TTdT} \times \Delta T) - (dR_{TTdV} \times \Delta V)$	$115 + (dR_{TTdT} \times \Delta T) + (dR_{TTdV} \times \Delta V)$	%	1,2

Note:

- $\Delta T = T - T$ (@ calibration), $\Delta V = V - V$ (@ calibration)
- dR_{ONdT}, dR_{ONdV}, dR_{TTdV}, and dR_{TTdT} are not subject to production test but are verified by design and characterization.

Output Driver Temperature and Voltage Sensitivity

Symbol	Parameter	Min	Max	Unit
dR _{ONdV}	R _{ON} Temperature Sensitivity	0.00	0.75	% / C
dR _{ONdV}	R _{ON} Voltage Sensitivity	0.00	0.20	% / mV
dR _{TTdT}	R _{TT} Temperature Sensitivity	0.00	0.75	% / C
dR _{TTdV}	R _{TT} Voltage Sensitivity	0.00	0.20	% / mV

R^{ONPU} and R^{ONPD} Characteristics without ZQ Calibration

Output driver impedance R_{ON} is defined by design and characterization as default setting.

Output Driver DC Electrical Characteristics without ZQ Calibration

R _{ON,Nom}	Resistor	Vout	Min	Nom	Max	Unit	Notes
34.3Ω	R _{ON34PD}	0.5 x V _{DDQ}	24	34.3	44.6		1
	R _{ON34PU}	0.5 x V _{DDQ}	24	34.3	44.6		1
40.0Ω	R _{ON40PD}	0.5 x V _{DDQ}	28	40	52		1
	R _{ON40PU}	0.5 x V _{DDQ}	28	40	52		1
48.0Ω	R _{ON48PD}	0.5 x V _{DDQ}	33.6	48	62.4		1
	R _{ON48PU}	0.5 x V _{DDQ}	33.6	48	62.4		1
60.0Ω (optional)	R _{ON60PD}	0.5 x V _{DDQ}	42	60	78		1
	R _{ON60PU}	0.5 x V _{DDQ}	42	60	78		1
80.0Ω (optional)	R _{ON80PD}	0.5 x V _{DDQ}	56	80	104		1
	R _{ON80PU}	0.5 x V _{DDQ}	56	80	104		1

Note: 1. Across entire operating temperature range, without calibration.

R_{ZQ} I-V Curve

Voltage[V]	R _{ON} = 240Ω(R _{ZQ})							
	Pull-Down				Pull-Up			
	Current [mA] / R _{ON} [Ohms]				Current [mA] / R _{ON} [Ohms]			
	default value after ZQReset		with Calibration		default value after ZQReset		with Calibration	
	Min	Max	Min	Max	Min	Max	Min	Max
	[mA]	[mA]	[mA]	[mA]	[mA]	[mA]	[mA]	[mA]
0.00	0.00	0.00	n/a	n/a	0.00	0.00	n/a	n/a
0.05	0.17	0.35	n/a	n/a	-0.17	-0.35	n/a	n/a
0.10	0.34	0.70	n/a	n/a	-0.34	-0.70	n/a	n/a
0.15	0.50	1.03	n/a	n/a	-0.50	-1.03	n/a	n/a
0.20	0.67	1.39	n/a	n/a	-0.67	-1.39	n/a	n/a
0.25	0.83	1.73	n/a	n/a	-0.83	-1.73	n/a	n/a
0.30	0.97	2.05	n/a	n/a	-0.97	-2.05	n/a	n/a
0.35	1.13	2.39	n/a	n/a	-1.13	-2.39	n/a	n/a
0.40	1.26	2.71	n/a	n/a	-1.26	-2.71	n/a	n/a
0.45	1.39	3.01	n/a	n/a	-1.39	-3.01	n/a	n/a
0.50	1.51	3.32	n/a	n/a	-1.51	-3.32	n/a	n/a
0.55	1.63	3.63	n/a	n/a	-1.63	-3.63	n/a	n/a
0.60	1.73	3.93	2.17	2.94	-1.73	-3.93	-2.17	-2.94
0.65	1.82	4.21	n/a	n/a	-1.82	-4.21	n/a	n/a
0.70	1.90	4.49	n/a	n/a	-1.90	-4.49	n/a	n/a
0.75	1.97	4.74	n/a	n/a	-1.97	-4.74	n/a	n/a
0.80	2.03	4.99	n/a	n/a	-2.03	-4.99	n/a	n/a
0.85	2.07	5.21	n/a	n/a	-2.07	-5.21	n/a	n/a
0.90	2.11	5.41	n/a	n/a	-2.11	-5.41	n/a	n/a
0.95	2.13	5.59	n/a	n/a	-2.13	-5.59	n/a	n/a
1.00	2.17	5.72	n/a	n/a	-2.17	-5.72	n/a	n/a
1.05	2.19	5.84	n/a	n/a	-2.19	-5.84	n/a	n/a
1.10	2.21	5.95	n/a	n/a	-2.21	-5.95	n/a	n/a
1.15	2.23	6.03	n/a	n/a	-2.23	-6.03	n/a	n/a
1.20	2.25	6.11	n/a	n/a	-2.25	-6.11	n/a	n/a

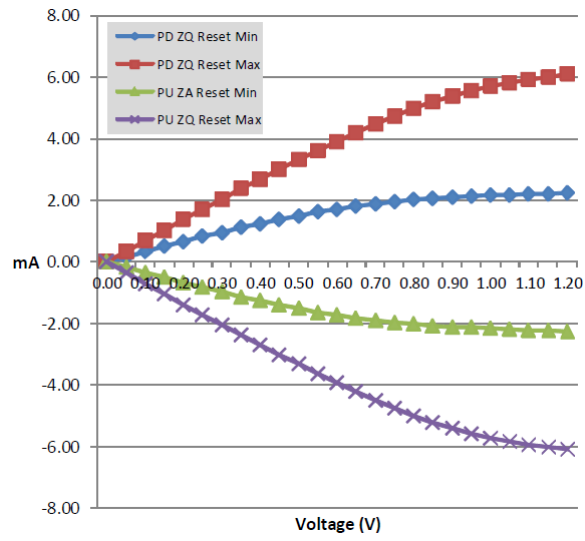

I-V Curve After ZQ Reset

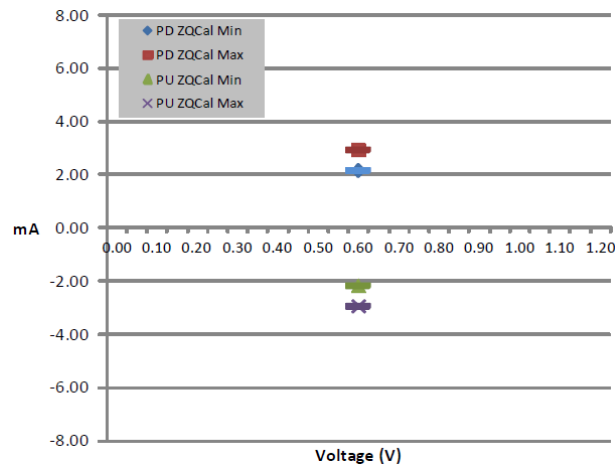

I-V Curve After Calibration

ODT Levels and I-V Characteristics

On-Die Termination effective resistance, R_{TT} , is defined by mode register MR11[1:0]. ODT is applied to the DQ, DM, and DQS_t/DQS_c pins. A functional representation of the on-die termination is shown in the figure below. R_{TT} is defined by the following formula:

$$R_{TTPU} = (V_{DDQ} - V_{OUT}) / |I_{OUT}|$$

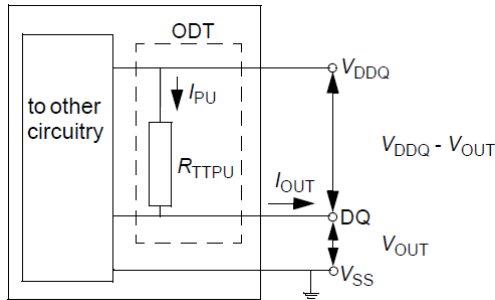

Functional representation of On-Die Termination

ODT DC Electrical Characteristics, assuming $R_{ZQ} = 240$ ohm after proper ZQ calibration

R_{TT} (ohm)	V_{OUT} (V)	I_{OUT}	
		Min (mA)	Max (ma)
$R_{ZQ}/1$	0.6	-2.17	-2.94
$R_{ZQ}/2$	0.6	-4.34	-5.88
$R_{ZQ}/4$	0.6	-8.68	-11.76

Input/Output Capacitance

Input/Output Capacitance Tables

Input/output capacitance

(T_{OPER} ; $V_{DDQ} = 1.14-1.3V$; $V_{DDCA} = 1.14-1.3V$; $V_{DD1} = 1.7-1.95V$, $V_{DD2} = 1.14-1.3V$)

Parameter	Symbol	Min/Max	Value	Units	Notes
Input capacitance, CK_t and CK_c	C _{CK}	Min	0.5	pF	1,2
		Max	1.2	pF	1,2
Input capacitance delta, CK_t and CK_c	C _{DCK}	Min	0	pF	1,2,3
		Max	0.15	pF	1,2,3
Input capacitance, all other input-only pins	C _I	Min	0.5	pF	1,2,4
		Max	1.1	pF	1,2,4
Input capacitance delta, all other input-only pins	C _{DI}	Min	-0.20	pF	1,2,5
		Max	0.20	pF	1,2,5
Input/output capacitance, DQ, DM, DQS_t, DQS_c	C _{IO}	Min	1.0	pF	1,2,6,7
		Max	1.8	pF	1,2,6,7
Input/output capacitance delta, DQS_t, DQS_c	C _{DDQS}	Min	0	pF	1,2,7,8
		Max	0.2	pF	1,2,7,8
Input/output capacitance delta, DQ, DM	C _{DIO}	Min	-0.25	pF	1,2,7,9
		Max	0.25	pF	1,2,7,9
Input/output capacitance ZQ Pin	C _{ZQ}	Min	0	pF	1,2
		Max	2.0	pF	1,2

Note:

1. This parameter applies to die device only (does not include package capacitance).
2. This parameter is not subject to production test. It is verified by design and characterization. The capacitance is measured according to JEP147 (Procedure for measuring input capacitance using a vector network analyzer (VNA) with V_{DD1} , V_{DD2} , V_{DDQ} , V_{SS} , V_{SSCA} , V_{SSQ} applied and all other pins floating).
3. Absolute value of $C_{CK_t} - C_{CK_c}$.
4. C_I applies to CS_n, CKE, CA0-CA9, ODT.
5. $C_{DI} = C_I - 0.5 * (C_{CK_t} + C_{CK_c})$
6. DM loading matches DQ and DQS.
7. MR3 I/O configuration DS OP3-OP0 = 0001B (34.3Ω typical)
8. Absolute value of C_{DQS_t} and C_{DQS_c} .
9. $C_{DIO} = C_{IO} - 0.5 * (C_{DQS_t} + C_{DQS_c})$ in byte-lane.

I_{DD} Specification Parameters and Test Conditions

I_{DD} Measurement Conditions

The following definitions are used within the I_{DD} measurement tables unless stated otherwise:

LOW: $V_{IN} \leq V_{IL(DC)} \text{ MAX}$

HIGH: $V_{IN} \geq V_{IH(DC)} \text{ MIN}$

STABLE: Inputs are stable at a HIGH or LOW level

SWITCHING: See Definition of Switching for CA Input Signals and Definition of Switching for I_{DD4R} table.

Definition of Switching for CA Input Signals

Switching for CA								
	CK _t (RISING) / CK _c (FALLING)	CK _t (FALLING) / CK _c (RISING)	CK _t (RISING) / CK _c (FALLING)	CK _t (FALLING) / CK _c (RISING)	CK _t (RISING) / CK _c (FALLING)	CK _t (FALLING) / CK _c (RISING)	CK _t (RISING) / CK _c (FALLING)	CK _t (FALLING) / CK _c (RISING)
Cycle	N		N+1		N+2		N+3	
CS _n	HIGH		HIGH		HIGH		HIGH	
CA0	HIGH	LOW	LOW	LOW	LOW	HIGH	HIGH	HIGH
CA1	HIGH	HIGH	HIGH	LOW	LOW	LOW	LOW	HIGH
CA2	HIGH	LOW	LOW	LOW	LOW	HIGH	HIGH	HIGH
CA3	HIGH	HIGH	HIGH	LOW	LOW	LOW	LOW	HIGH
CA4	HIGH	LOW	LOW	LOW	LOW	HIGH	HIGH	HIGH
CA5	HIGH	HIGH	HIGH	LOW	LOW	LOW	LOW	HIGH
CA6	HIGH	LOW	LOW	LOW	LOW	HIGH	HIGH	HIGH
CA7	HIGH	HIGH	HIGH	LOW	LOW	LOW	LOW	HIGH
CA8	HIGH	LOW	LOW	LOW	LOW	HIGH	HIGH	HIGH
CA9	HIGH	HIGH	HIGH	LOW	LOW	LOW	LOW	HIGH

Note:

1. CS_n must always be driven HIGH.
2. 50% of CA bus is changing between HIGH and LOW once per clock for the CA bus.
3. The above pattern (N, N+1, N+2, N+3...) is used continuously during I_{DD} measurement for I_{DD} values that require SWITCHING on the CA bus.

Definition of Switching for I_{DD4R}

Clock	CKE	CS_n	Clock Cycle Number	Command	CA[0:2]	CA[3:9]	All DQ
Rising	H	L	N	Read_Rising	HLH	LHLHLHL	L
Falling	H	L	N	Read_Falling	LLL	LLLLLLL	L
Rising	H	H	N + 1	NOP	LLL	LLLLLLL	H
Falling	H	H	N + 1	NOP	LLL	LLLLLLL	L
Rising	H	H	N + 2	NOP	LLL	LLLLLLL	H
Falling	H	H	N + 2	NOP	LLL	LLLLLLL	H
Rising	H	H	N + 3	NOP	LLL	LLLLLLL	H
Falling	H	H	N + 3	NOP	HLH	HLHLLHL	L
Rising	H	L	N + 4	Read_Rising	HLH	HLHLLHL	H
Falling	H	L	N + 4	Read_Falling	LHH	HHHHHHH	H
Rising	H	H	N + 5	NOP	HHH	HHHHHHH	H
Falling	H	H	N + 5	NOP	HHH	HHHHHHH	L
Rising	H	H	N + 6	NOP	HHH	HHHHHHH	L
Falling	H	H	N + 6	NOP	HHH	HHHHHHH	L
Rising	H	H	N + 7	NOP	HHH	HHHHHHH	H
Falling	H	H	N + 7	NOP	HLH	LHLHLHL	L

Note:

1. Data strobe (DQS) is changing between HIGH and LOW every clock cycle.
2. The above pattern (N, N+1...) is used continuously during I_{DD} measurement for I_{DD4R}.

Definition of Switching for I_{DD4W}

Clock	CKE	CS_n	Clock Cycle Number	Command	CA[0:2]	CA[3:9]	All DQ
Rising	H	L	N	Write_Rising	HLL	LHLHLHL	L
Falling	H	L	N	Write_Falling	LLL	LLLLLLL	L
Rising	H	H	N + 1	NOP	LLL	LLLLLLL	H
Falling	H	H	N + 1	NOP	LLL	LLLLLLL	L
Rising	H	H	N + 2	NOP	LLL	LLLLLLL	H
Falling	H	H	N + 2	NOP	LLL	LLLLLLL	H
Rising	H	H	N + 3	NOP	LLL	LLLLLLL	H
Falling	H	H	N + 3	NOP	HLL	HLHLHL	L
Rising	H	L	N + 4	Write_Rising	HLL	HLHLHL	H
Falling	H	L	N + 4	Write_Falling	LHH	HHHHHHH	H
Rising	H	H	N + 5	NOP	HHH	HHHHHHH	H
Falling	H	H	N + 5	NOP	HHH	HHHHHHH	L
Rising	H	H	N + 6	NOP	HHH	HHHHHHH	L
Falling	H	H	N + 6	NOP	HHH	HHHHHHH	L
Rising	H	H	N + 7	NOP	HHH	HHHHHHH	H
Falling	H	H	N + 7	NOP	HLL	LHLHLHL	L

Note:

1. Data strobe (DQS) is changing between HIGH and LOW every clock cycle.
2. Data masking (DM) must always be driven LOW.
3. The above pattern (N, N+1...) is used continuously during I_{DD} measurement for I_{DD4W}.

I_{DD} Specifications

I_{DD} values are for the entire operating voltage range, and all of them are for the entire standard range, with the exception of I_{DD6ET} which is for the entire extended temperature range.

Notes 1, 2, 3 apply for all values.

Parameter/Condition	Symbol	Power Supply	Value			Unit	Note
			1600	1866	2133		
Operating one bank active-precharge current: t _{CK} = t _{CKmin} ; t _{RC} = t _{RCmin} ; CKE is HIGH; CS _n is HIGH between valid commands; CA bus inputs are switching; Data bus inputs are stable ODT disabled	I _{DD01}	V _{DD1}	20	20	20	mA	
	I _{DD02}	V _{DD2}	36	37	39	mA	
	I _{DD0in}	V _{DDCA} , V _{DDQ}	8	8	8	mA	3
Idle power-down standby current: t _{CK} = t _{CKmin} ; CKE is LOW; CS _n is HIGH; All banks are idle; CA bus inputs are switching; Data bus inputs are stable ODT disabled	I _{DD2P1}	V _{DD1}	2.5	2.5	2.5	mA	
	I _{DD2P2}	V _{DD2}	6	6	6	mA	
	I _{DD2P,in}	V _{DDCA} , V _{DDQ}	0.2	0.2	0.2	mA	3
Idle power-down standby current with clock stop: CK _t = LOW, CK _c = HIGH; CKE is LOW; CS _n is HIGH; All banks are idle; CA bus inputs are stable; Data bus inputs are stable ODT disabled	I _{DD2PS1}	V _{DD1}	2.5	2.5	2.5	mA	
	I _{DD2PS2}	V _{DD2}	6	6	6	mA	
	I _{DD2PS,in}	V _{DDCA} , V _{DDQ}	0.2	0.2	0.2	mA	3
Idle non-power-down standby current: t _{CK} = t _{CKmin} ; CKE is HIGH; CS _n is HIGH; All banks are idle; CA bus inputs are switching; Data bus inputs are stable ODT disabled	I _{DD2N1}	V _{DD1}	2.5	2.5	2.5	mA	
	I _{DD2N2}	V _{DD2}	11	12	13	mA	
	I _{DD2N,in}	V _{DDCA} , V _{DDQ}	8	8	8	mA	3
Idle non-power-down standby current with clock stopped: CK _t = LOW; CK _c = HIGH; CKE is HIGH; CS _n is HIGH; All banks are idle; CA bus inputs are stable; Data bus inputs are stable ODT disabled	I _{DD2NS1}	V _{DD1}	2.5	2.5	2.5	mA	
	I _{DD2NS2}	V _{DD2}	6	6	6	mA	
	I _{DD2NS,in}	V _{DDCA} , V _{DDQ}	8	8	8	mA	3
Active power-down standby current: t _{CK} = t _{CKmin} ; CKE is LOW; CS _n is HIGH; One bank is active; CA bus inputs are switching; Data bus inputs are stable ODT disabled	I _{DD3P1}	V _{DD1}	8	8	8	mA	
	I _{DD3P2}	V _{DD2}	6	6	6	mA	
	I _{DD3P,in}	V _{DDCA} , V _{DDQ}	0.2	0.2	0.2	mA	3

Parameter/Condition	Symbol	Power Supply	Value			Unit	Note
			1600	1866	2133		
Active power-down standby current with clock stop: CK = LOW, CK# = HIGH; CKE is LOW; CS_n is HIGH; One bank is active; CA bus inputs are stable; Data bus inputs are stable ODT disabled	I _{DD3PS1}	V _{DD1}	8	8	8	mA	
	I _{DD3PSS2}	V _{DD2}	6	6	6	mA	
	I _{DD3PS,in}	V _{DDCA} , V _{DDQ}	0.2	0.2	0.2	mA	4
Active non-power-down standby current: t _{CK} = t _{CKmin} ; CKE is HIGH; CS_n is HIGH; One bank is active; CA bus inputs are switching; Data bus inputs are stable ODT disabled	I _{DD3N1}	V _{DD1}	8	8	8	mA	
	I _{DD3N2}	V _{DD2}	13	14	15	mA	
	I _{DD3N,in}	V _{DDCA} , V _{DDQ}	8	8	8	mA	4
Active non-power-down standby current with clock stopped: CK = LOW, CK# = HIGH CKE is HIGH; CS_n is HIGH; One bank is active; CA bus inputs are stable; Data bus inputs are stable ODT disabled	I _{DD3NS1}	V _{DD1}	8	8	8	mA	
	I _{DD3NS2}	V _{DD2}	6	6	6	mA	
	I _{DD3NS,in}	V _{DDCA} , V _{DDQ}	8	8	8	mA	4
Operating burst READ current: t _{CK} = t _{CKmin} ; CS_n is HIGH between valid commands; One bank is active; BL = 8; RL = RL (MIN); CA bus inputs are switching; 50% data change each burst transfer ODT disabled	I _{DD4R1}	V _{DD1}	10	10	10	mA	
	I _{DD4R2}	V _{DD2}	167	191	215	mA	
	I _{DD4R,in}	V _{DDCA}	8	8	8	mA	
	I _{DD4RQ}	V _{DDQ}	-	-	-	mA	5
Operating burst WRITE current: t _{CK} = t _{CKmin} ; CS_n is HIGH between valid commands; One bank is active; BL = 8; WL = WLmin; CA bus inputs are switching; 50% data change each burst transfer ODT disabled	I _{DD4W1}	V _{DD1}	10	10	10	mA	
	I _{DD4W2}	V _{DD2}	172	199	225	mA	4
	I _{DD4W,in}	V _{DDCA} , V _{DDQ}	34	34	34	mA	
All-bank REFRESH burst current: t _{CK} = t _{CKmin} ; CKE is HIGH between valid commands; t _{RC} = t _{RFCabmin} ; Burst refresh; CA bus inputs are switching; Data bus inputs are stable ODT disabled	I _{DD51}	V _{DD1}	48	48	48	mA	
	I _{DD52}	V _{DD2}	60	62	63	mA	4
	I _{DD5in}	V _{DDCA} , V _{DDQ}	8	8	8	mA	

Parameter/Condition	Symbol	Power Supply	Value			Unit	Note
			1600	1866	2133		
All-bank REFRESH average current: $t_{CK} = t_{CKmin}$; CKE is HIGH between valid commands; $t_{RC} = RM \times t_{REFI}$; CA bus inputs are switching; Data bus inputs are stable ODT disabled	I_{DD5AB1}	V_{DD1}	4	4	4	mA	
	I_{DD5AB2}	V_{DD2}	13	14	15	mA	
	$I_{DD5AB,in}$	V_{DDCA}, V_{DDQ}	8	8	8	mA	4
Per-bank REFRESH average current: $t_{CK} = t_{CKmin}$; CKE is HIGH between valid commands; $t_{RC} = RM \times t_{REFI}/8$; CA bus inputs are switching; Data bus inputs are stable ODT disabled	I_{DD5PB1}	V_{DD1}	4	4	4	mA	
	I_{DD5PB2}	V_{DD2}	14	14	15	mA	
	$I_{DD5PB,in}$	V_{DDCA}, V_{DDQ}	8	8	8	mA	4
Self refresh current (-25°C to +85°C): $CK_t = LOW, CK_c = HIGH$; CKE is LOW; CA bus inputs are stable; Data bus inputs are stable Maximum 1x self refresh rate ODT disabled	I_{DD61}	V_{DD1}	3.6	3.6	3.6	mA	6, 7, 9
	I_{DD62}	V_{DD2}	6	6	6	mA	6, 7, 9
	I_{DD6IN}	V_{DDCA}, V_{DDQ}	0.2	0.2	0.2	mA	4, 6, 7, 9
Self refresh current (+85°C to +95°C): $CK_t = LOW, CK_c = HIGH$; CKE is LOW; CA bus inputs are stable; Data bus inputs are stable ODT disabled	I_{DD6ET1}	V_{DD1}	4	4	4	mA	7, 8, 9
	I_{DD6ET2}	V_{DD2}	7	7	7	mA	7, 8, 9
	$I_{DD6ET,in}$	V_{DDCA}, V_{DDQ}	0.2	0.2	0.2	mA	4, 7, 8, 9
Deep power-down current: $CK_t = LOW, CK_c = HIGH$; CKE is LOW; CA bus inputs are stable; Data bus inputs are stable ODT disabled	I_{DD81}	V_{DD1}	0.08	0.08	0.08	mA	
	I_{DD82}	V_{DD2}	0.15	0.15	0.15	mA	
	I_{DD8IN}	V_{DDCA}, V_{DDQ}	0.15	0.15	0.15	mA	4

Note:

1. Published I_{DD} values are the maximum of the distribution of the arithmetic mean.
2. ODT disabled: MR11[2:0] = 000B.
3. I_{DD} current specifications are tested after the device is properly initialized.
4. Measured currents are the summation of V_{DDQ} and V_{DDCA} .
5. Guaranteed by design with output load = 5 pF and $R_{ON} = 40$ ohm.
6. The 1x self refresh rate is the rate at which the device is refreshed internally during self refresh, before going into the elevated temperature range.
7. This is the general definition that applies to full-array SELF REFRESH.
8. I_{DD6ET} is a typical value, is sampled only, and is not tested.
9. Supplier datasheets may contain additional Self-Refresh I_{DD} values for temperature subranges within the standard or elevated temperature ranges.
10. For all I_{DD} measurements, $V_{IHCKE} = 0.8 \times V_{DDCA}$, $V_{ILCKE} = 0.2 \times V_{DDCA}$.

I_{DD6} Partial Array Self-Refresh Current

Parameter		Supply	Value	Unit
I _{DD6} Partial Array Self-Refresh Current CK _t = LOW, CK _c = HIGH; CKE is LOW; CA bus inputs are STABLE; Data bus inputs are STABLE; ODT disabled	Full Array	V _{DD1}	3.6	mA
		V _{DD2}	6	mA
		V _{DDCA} , V _{DDQ}	0.2	mA
	1/2 Array	V _{DD1}	3.4	mA
		V _{DD2}	5.8	mA
		V _{DDCA} , V _{DDQ}	0.2	mA
	1/4 Array	V _{DD1}	3.2	mA
		V _{DD2}	5.6	mA
		V _{DDCA} , V _{DDQ}	0.2	mA
	1/8 Array	V _{DD1}	3	mA
		V _{DD2}	5.4	mA
		V _{DDCA} , V _{DDQ}	0.2	mA

Note:

1. I_{DD6} currents are measured using bank-masking only.
2. I_{DD} values published are the maximum of the distribution of the arithmetic mean.

Electrical Characteristics and AC Timing

Clock Specification

The jitter specified is a random jitter meeting a Gaussian distribution. Input clocks violating the min/max values may result in malfunction of the LPDDR3 device.

Definition for $t_{CK(avg)}$ and nCK

$t_{CK(avg)}$ is calculated as the average clock period across any consecutive 200 cycle window, where each clock period is calculated from rising edge to rising edge.

$$t_{CK(avg)} = \left(\sum_{j=1}^N t_{CK_j} \right) / N$$

where $N = 200$

Unit ' $t_{CK(avg)}$ ' represents the actual clock average $t_{CK(avg)}$ of the input clock under operation. Unit ' nCK ' represents one clock cycle of the input clock, counting the actual clock edges.

$t_{CK(avg)}$ may change by up to +/-1% within a 100 clock cycle window, provided that all jitter and timing specs are met.

Definition for $t_{CK(abs)}$

$t_{CK(abs)}$ is defined as the absolute clock period, as measured from one rising edge to the next consecutive rising edge.

$t_{CK(abs)}$ is not subject to production test.

Definition for $t_{CH(avg)}$ and $t_{CL(avg)}$

$t_{CH(avg)}$ is defined as the average high pulse width, as calculated across any consecutive 200 high pulses.

$$t_{CH(avg)} = \left(\sum_{j=1}^N t_{CH_j} \right) / (N \times t_{CK(avg)})$$

where $N = 200$

$t_{CL(avg)}$ is defined as the average low pulse width, as calculated across any consecutive 200 low pulses.

$$t_{CL(avg)} = \left(\sum_{j=1}^N t_{CL_j} \right) / (N \times t_{CK(avg)})$$

where $N = 200$

Definition for $t_{\text{JIT(per)}}$

$t_{\text{JIT(per)}}$ is the single period jitter defined as the largest deviation of any signal t_{CK} from $t_{\text{CK(avg)}}$.

$t_{\text{JIT(per)}} = \text{Min/max of } \{t_{\text{CK}_i} - t_{\text{CK(avg)}} \text{ where } i = 1 \text{ to } 200\}$.

$t_{\text{JIT(per),act}}$ is the actual clock jitter for a given system.

$t_{\text{JIT(per),allowed}}$ is the specified allowed clock period jitter.

$t_{\text{JIT(per)}}$ is not subject to production test.

Definition for $t_{\text{JIT(cc)}}$

$t_{\text{JIT(cc)}}$ is defined as the absolute difference in clock period between two consecutive clock cycles.

$t_{\text{JIT(cc)}} = \text{Max of } |t_{\text{CK}_{i+1}} - t_{\text{CK}_i}|$.

$t_{\text{JIT(cc)}}$ defines the cycle to cycle jitter.

$t_{\text{JIT(cc)}}$ is not subject to production test.

Definition for $t_{\text{ERR(nper)}}$

$t_{\text{ERR(nper)}}$ is defined as the cumulative error across n multiple consecutive cycles from $t_{\text{CK(avg)}}$.

$t_{\text{ERR(nper),act}}$ is the actual clock jitter over n cycles for a given system.

$t_{\text{ERR(nper),allowed}}$ is the specified allowed clock period jitter over n cycles.

$t_{\text{ERR(nper)}}$ is not subject to production test.

$$t_{\text{ERR(nper)}} = \left(\sum_{j=i}^{i+n-1} t_{\text{CK}_j} \right) - n \times t_{\text{CK(avg)}}$$

$t_{\text{ERR(nper),min}}$ can be calculated by the formula:

$$t_{\text{ERR(nper),min}} = (1 + 0.68\text{LN}(n)) \times t_{\text{JIT(per),min}}$$

$t_{\text{ERR(nper),max}}$ can be calculated by the formula:

$$t_{\text{ERR(nper),max}} = (1 + 0.68\text{LN}(n)) \times t_{\text{JIT(per),max}}$$

Using these equations, $t_{\text{ERR(nper)}}$ tables can be generated for each $t_{\text{JIT(per),act}}$ value.

Definition for duty cycle jitter $t_{JIT(duty)}$

$t_{JIT(duty)}$ is defined with absolute and average specification of t_{CH} / t_{CL} .

$$t_{JIT(duty),min} = \text{MIN}((t_{CH(ABS),min} - t_{CH(AVG),min}), (t_{CL(ABS),min} - t_{CL(AVG),min})) \times t_{CK(AVG)}$$

$$t_{JIT(duty),max} = \text{MAX}((t_{CH(ABS),max} - t_{CH(AVG),max}), (t_{CL(ABS),max} - t_{CL(AVG),max})) \times t_{CK(AVG)}$$

Definition for $t_{CK(ABS)}$, $t_{CH(ABS)}$ and $t_{CL(ABS)}$

These parameters are specified per their average values, however it is understood that the following relationship between the average timing and the absolute instantaneous timing holds at all times.

Definition for $t_{CK(ABS)}$, $t_{CH(ABS)}$ and $t_{CL(ABS)}$

Parameter	Symbol	Min	Unit
Absolute Clock Period	$t_{CK(ABS)}$	$t_{CK(AVG),min} + t_{JIT(per),min}$	ps
Absolute Clock HIGH Pulse Width	$t_{CH(ABS)}$	$t_{CH(AVG),min} + t_{JIT(duty),min} / t_{CK(AVG),min}$	$t_{CK(AVG)}$
Absolute Clock LOW Pulse Width	$t_{CL(ABS)}$	$t_{CL(AVG),min} + t_{JIT(duty),min} / t_{CK(AVG),min}$	$t_{CK(AVG)}$

Note:

- $t_{CK(AVG),min}$ is expressed in ps in this table.
- $t_{JIT(duty),min}$ is a negative value.

Period Clock Jitter

LPDDR3 devices can tolerate some clock period jitter without core timing parameter de-rating. This section describes device timing requirements in the presence of clock period jitter ($t_{JIT(per)}$) in excess of the values found in AC timing table and how to determine cycle time de-rating and clock cycle de-rating.

Clock period jitter effects on core timing parameters (t_{RCD} , t_{RP} , t_{RTP} , t_{WR} , t_{WRA} , t_{WTR} , t_{RC} , t_{RAS} , t_{RRD} , t_{FAW})

Core timing parameters extend across multiple clock cycles. Period clock jitter will impact these parameters when measured in numbers of clock cycles. When the device is operated with clock jitter within the specification limits, the LPDDR3 device is characterized and verified to support $tnPARAM = RU\{t_{PARAM} / t_{CK(avg)}\}$.

When the device is operated with clock jitter outside specification limits, the number of clocks or $t_{CK(avg)}$ may need to be increased based on the values for each core timing parameter.

Cycle time de-rating for core timing parameters

For a given number of clocks ($tnPARAM$), for each core timing parameter, average clock period ($t_{CK(avg)}$) and actual cumulative period error ($t_{ERR}(tnPARAM),act$) in excess of the allowed cumulative period error ($t_{ERR}(tnPARAM),allowed$), the equation below calculates the amount of cycle time de-rating (in ns) required if the equation results in a positive value for a core timing parameter.

$$CycleTimeDerating = MAX\left\{\left(\frac{t_{PARAM} + t_{ERR}(tnPARAM),act - t_{ERR}(tnPARAM),allowed}{tnPARAM} - t_{CK(avg)}\right), 0\right\}$$

A cycle time derating analysis should be conducted for each core timing parameter. The amount of cycle time derating required is the maximum of the cycle time de-ratings determined for each individual core timing parameter.

Clock Cycle de-rating for core timing parameters

For a given number of clocks ($tnPARAM$) for each core timing parameter, clock cycle de-rating should be specified with amount of period jitter ($t_{JIT(per)}$).

For a given number of clocks ($tnPARAM$), for each core timing parameter, average clock period ($t_{CK(avg)}$) and actual cumulative period error ($t_{ERR}(tnPARAM),act$) in excess of the allowed cumulative period error ($t_{ERR}(tnPARAM),allowed$), the equation below calculates the clock cycle derating (in clocks) required if the equation results in a positive value for a core timing parameter.

$$ClockCycleDerating = RU\left\{\frac{t_{PARAM} + t_{ERR}(tnPARAM),act - t_{ERR}(tnPARAM),allowed}{t_{CK(avg)}}\right\} - tnPARAM$$

A clock cycle de-rating analysis should be conducted for each core timing parameter.

Clock jitter effects on Command/Address timing parameters (t_{ISCA} , t_{IHCA} , t_{ISCS} , t_{IHCS} , t_{ISCKE} , t_{IHCKE} , t_{ISb} , t_{IHb} , t_{ISCKEb} , t_{IHCKEb})

These parameters are measured from a command/address signal (CKE, CS, CA0 - CA9) transition edge to its respective clock signal (CK_t/CK_c) crossing. The spec values are not affected by the amount of clock jitter applied (i.e. $t_{JIT(per)}$, as the setup and hold are relative to the clock signal crossing that latches the command/address.

Regardless of clock jitter values, these values shall be met.

Clock jitter effects on Read timing parameters

t_{RPRE}

When the device is operated with input clock jitter, t_{RPRE} needs to be de-rated by the actual period jitter ($t_{JIT(per),act,max}$) of the input clock in excess of the allowed period jitter ($t_{JIT(per),allowed,max}$). Output de-ratings are relative to the input clock.

$t_{RPRE(min, derated)} = 0.9 -$	$\frac{t_{JIT(per), act,max} - t_{JIT(per),allowed,max}}{t_{CK(avg)}}$
----------------------------------	--

For example,

if the measured jitter into a LPDDR3-1600 device has $t_{CK(avg)} = 1250$ ps, $t_{JIT(per),act,min} = -92$ ps and $t_{JIT(per),act,max} = +134$ ps, then $t_{RPRE,min,derated} = 0.9 - (t_{JIT(per),act,max} - t_{JIT(per),allowed,max})/t_{CK(avg)} = 0.9 - (134 - 100)/1250 = .8728 t_{CK(avg)}$

$t_{LZ(DQ)}$, $t_{HZ(DQ)}$, t_{DQSCK} , $t_{LZ(DQS)}$, $t_{HZ(DQS)}$

These parameters are measured from a specific clock edge to a data signal (DMn, DQm.: n=0,1,2,3. m=0–31) transition and will be met with respect to that clock edge. Therefore, they are not affected by the amount of clock jitter applied (i.e. $t_{JIT(per)}$).

t_{QSH} , t_{QSL}

These parameters are affected by duty cycle jitter which is represented by $t_{CH(abs)min}$ and $t_{CL(abs)min}$. These parameters determine absolute Data-Valid Window (DVW) at the LPDDR3 device pin.

Absolute min DVW @ LPDDR3 device pin = $\min\{ (t_{QSH(abs)min} - t_{DQSQmax}), (t_{QSL(abs)min} - t_{DQSQmax}) \}$ This minimum DVW shall be met at the target frequency regardless of clock jitter.

t_{RPST}

t_{RPST} is affected by duty cycle jitter which is represented by $t_{CL(abs)}$. Therefore $t_{RPST(abs)min}$ can be specified by $t_{CL(abs)min}$.

$$t_{RPST(abs)min} = t_{CL(abs)min} - 0.05 = t_{QSL(abs)min}$$

Clock jitter effects on Write timing parameters

t_{DS} , t_{DH}

These parameters are measured from a data signal (DM_n, DQ_m: n=0,1,2,3. m=0 –31) transition edge to its respective data strobe signal (DQSn_t, DQSn_c : n=0,1,2,3) crossing. The spec values are not affected by the amount of clock jitter applied (i.e. $t_{JIT(per)}$, as the setup and hold are relative to the data strobe signal crossing that latches the data. Regardless of clock jitter values, these values shall be met.

t_{DSS} , t_{DSH}

These parameters are measured from a data strobe signal (DQSx_t, DQSx_c) crossing to its respective clock signal (CK_t/CK_c) crossing. The spec values are not affected by the amount of clock jitter applied (i.e. $t_{JIT(per)}$, as the setup and hold of the data strobes are relative to the corresponding clock signal crossing. Regardless of clock jitter values, these values shall be met.

t_{DQSS}

This parameter is measured from a data strobe signal (DQSx_t, DQSx_c) crossing to the subsequent clock signal (CK_t/CK_c) crossing. When the device is operated with input clock jitter, this parameter needs to be de-rated by the actual period jitter $t_{JIT(per),act}$ of the input clock in excess of the allowed period jitter $t_{JIT(per),allowed}$.

$t_{DQSS(min, derated)} = 0.75 -$	$\frac{t_{JIT(per), act, min} - t_{JIT(per), allowed, min}}{t_{CK(avg)}}$
$t_{DQSS(max, derated)} = 0.75 -$	$\frac{t_{JIT(per), act, max} - t_{JIT(per), allowed, max}}{t_{CK(avg)}}$

For example,

if the measured jitter into a LPDDR3-1600 device has $t_{CK(avg)} = 1250$ ps, $t_{JIT(per),act,min} = -93$ ps and $t_{JIT(per),act,max} = +134$ ps, then $t_{DQSS,(min,derated)} = 0.75 - (t_{JIT(per),act,min} - t_{JIT(per),allowed,min})/t_{CK(avg)} = 0.75 - (-93 + 100)/1250 = 0.7444 t_{CK(avg)}$ and $t_{DQSS,(max,derated)} = 1.25 - (t_{JIT(per),act,max} - t_{JIT(per),allowed,max})/t_{CK(avg)} = 1.25 - (134 - 100)/1250 = 1.2228 t_{CK(avg)}$

LPDDR3 Refresh Requirements by Device Density

LPDDR3 Refresh Requirement Parameters (per density)

Parameter	Symbol	1Gb	Unit	
Number of Banks		8	-	
Refresh Window $T_{case} \leq 85^{\circ}C$	t_{REFW}	32	ms	
Refresh Window 1/2-Rate Refresh	t_{REFW}	16	ms	
Refresh Window 1/4-Rate Refresh	t_{REFW}	8	ms	
Required number of REFRESH commands (min)	R	4,096	-	
average time between REFRESH commands (for reference only) $T_{case} \leq 85^{\circ}C$	REFab	t_{REFI}	7.8	us
	REFpb	t_{REFIpb}	0.975	us
Refresh Cycle time	t_{RFCab}	130	ns	
Per Bank Refresh Cycle time	t_{RFCpb}	60	ns	

Note: 1. Please refer to LPDDR3 SDRAM Addressing

LPDDR3 Read and Write Latencies

Parameter	Value			Unit
	800	933	1066	
Max. Clock Frequency	800	933	1066	MHz
Max. Data Rate	1600	1866	2133	MT/s
Average Clock Period	1.25	1.071	0.938	ns
Read Latency	12	14	16	$t_{CK(avg)}$
Write Latency (Set A)	6	8	8	$t_{CK(avg)}$
Write Latency (Set B) ²	9	11	13	$t_{CK(avg)}$

Note:

1. RL=3/WL=1 setting is an optional feature. Refer to MR0 OP<7>.
2. Write Latency (Set B) support is an optional feature. Refer to MR0 OP<6>.

AC Timing

Notes 1, 2, 3 and 4 apply to all parameters. Notes begin below table.

Parameter	Symbol	Min/ Max	Data Rate			Unit
			1600	1866	2133	
Maximum clock frequency	f_{CK}	–	800	933	1066	MHz
Clock Timing						
Average clock period	$t_{CK(avg)}$	MIN	1.25	1.071	0.938	ns
		MAX	100			
Average HIGH pulse width	$t_{CH(avg)}$	MIN	0.45			$t_{CK(avg)}$
		MAX	0.55			
Average LOW pulse width	$t_{CL(avg)}$	MIN	0.45			$t_{CK(avg)}$
		MAX	0.55			
Absolute clock period	$t_{CK(abs)}$	MIN				ns
Absolute clock HIGH pulse width	$t_{CH(abs)}$	MIN	0.43			$t_{CK(avg)}$
		MAX	0.57			
Absolute clock LOW pulse width	$t_{CL(abs)}$	MIN	0.43			$t_{CK(avg)}$
		MAX	0.57			
Clock period jitter (with supported jitter)	$t_{JIT(per), allowed}$	MIN	-70	-60	-50	ps
		MAX	70	60	50	
Maximum Clock Jitter between two consecutive clock cycles (with allowed jitter)	$t_{JIT(cc), allowed}$	MAX	140	120	100	ps
Duty cycle jitter (with supported jitter)	$t_{JIT(duty), allowed}$	MIN	$\min((t_{CH(abs),min} - t_{CH(avg),min}), (t_{CL(abs),min} - t_{CL(avg),min})) \times t_{CK(avg)}$			ps
		MAX	$\max((t_{CH(abs),max} - t_{CH(avg),max}), (t_{CL(abs),max} - t_{CL(avg),max})) \times t_{CK(avg)}$			
Cumulative errors across 2 cycles	$t_{ERR(2per), allowed}$	MIN	-103	-88	-74	ps
		MAX	103	88	74	
Cumulative errors across 3 cycles	$t_{ERR(3per), allowed}$	MIN	-122	-105	-87	ps
		MAX	122	105	87	
Cumulative errors across 4 cycles	$t_{ERR(4per), allowed}$	MIN	-136	-117	-97	ps
		MAX	136	117	97	
Cumulative errors across 5 cycles	$t_{ERR(5per), allowed}$	MIN	-147	-126	-105	ps
		MAX	147	126	105	
Cumulative errors across 6 cycles	$t_{ERR(6per), allowed}$	MIN	-155	-133	-111	ps
		MAX	155	133	111	
Cumulative errors across 7 cycles	$t_{ERR(7per), allowed}$	MIN	-163	-139	-116	ps
		MAX	163	139	116	

Parameter	Symbol	Min/ Max	Data Rate			Unit
			1600	1866	2133	
Cumulative errors across 8 cycles	$t_{ERR(8per), allowed}$	MIN	-169	-145	-121	ps
		MAX	169	145	121	
Cumulative errors across 9 cycles	$t_{ERR(9per), allowed}$	MIN	-175	-150	125	ps
		MAX	175	150	125	
Cumulative errors across 10 cycles	$t_{ERR(10per), allowed}$	MIN	-180	-154	-128	ps
		MAX	180	154	128	
Cumulative errors across 11 cycles	$t_{ERR(11per), allowed}$	MIN	-184	-158	-132	ps
		MAX	184	158	132	
Cumulative errors across 12 cycles	$t_{ERR(12per), allowed}$	MIN	-188	-161	-134	ps
		MAX	188	161	134	
Cumulative errors across n = 13, 14, 15..., 19, 20 cycles	$t_{ERR(nper), allowed}$	MIN	$t_{ERR(nper), allowed} MIN = (1 + 0.68\ln(n)) \times t_{JIT(per), allowed} MIN$			pss
		MAX	$t_{ERR(nper), allowed} MAX = (1 + 0.68\ln(n)) \times t_{JIT(per), allowed} MAX$			
ZQ Calibration Parameters						
Initialization calibration time	t_{ZQINIT}	MIN	1			μs
Long calibration time	t_{ZQCL}	MIN	360			ns
Short calibration time	t_{ZQCS}	MIN	90			ns
Calibration RESET time	$t_{ZQRESET}$	MIN	max(50ns, 3nCK)			ns
READ Parameters⁵						
DQS output access time from CK_t/CK_c	t_{DQSCK}	MIN	2500			psps
		MAX	5500			
DQSCK delta short ⁶	$t_{DQSCKDS}$	MAX	220	190	165	ps
DQSCK delta medium ⁷	$t_{DQSCKDM}$	MAX	511	435	380	ps
DQSCK delta long ⁸	$t_{DQSCKDL}$	MAX	614	525	460	ps
DQS-DQ skew	t_{DQSQ}	MAX	135	115	100	ps
DQS output HIGH pulse width	t_{QSH}	MIN	$t_{CH(abs)} - 0.05$			$t_{CK(avg)}$
DQS output LOW pulse width	t_{QSL}	MIN	$t_{CL(abs)} - 0.05$			$t_{CK(avg)}$
DQ/DQS output hold time from DQS	t_{QH}	MIN	min(t_{QSH} , t_{QSL})			ps
READ preamble ^{9, 12}	t_{RPRE}	MIN	0.9			$t_{CK(avg)}$
READ postamble ^{9, 13}	t_{RPST}	MIN	0.3			$t_{CK(avg)}$
DQS Low-Z from clock ⁹	$t_{LZ(DQS)}$	MIN	$t_{DQSCK(MIN)} - 300$			ps
DQ Low-Z from clock ⁹	$t_{LZ(DQ)}$	MIN	$t_{DQSCK(MIN)} - 300$			ps
DQS High-Z from clock ⁹	$t_{HZ(DQS)}$	MAX	$t_{DQSCK(MAX)} - 100$			ps

Parameter	Symbol	Min/ Max	Data Rate			Unit
			1600	1866	2133	
DQ High-Z from clock ⁹	t _{HZ(DQ)}	MAX	t _{DQSCK,(MAX)} + (1.4 × t _{DQSQ,(MAX)})			ps
WRITE Parameters⁵						
DQ and DM input hold time (V _{REF} based)	t _{DH}	MIN	150	130	115	ps
DQ and DM input setup time (V _{REF} based)	t _{DS}	MIN	150	130	115	ps
DQ and DM input pulse width	t _{DIPW}	MIN	0.35			t _{CK(avg)}
Write command to 1st DQS latching transition	t _{DQSS}	MIN	0.75			t _{CK(avg)}
		MAX	1.25			
DQS input high-level width	t _{DQSH}	MIN	0.4			t _{CK(avg)}
DQS input low-level width	t _{DQSL}	MIN	0.4			t _{CK(avg)}
DQS falling edge to CK setup time	t _{DSS}	MIN	0.2			t _{CK(avg)}
DQS falling edge hold time from CK	t _{DSH}	MIN	0.2			t _{CK(avg)}
Write postamble	t _{WPST}	MIN	0.4			t _{CK(avg)}
Write preamble	t _{WPRE}	MIN	0.8			t _{CK(avg)}
CKE Input Parameters						
CKE minimum pulse width (HIGH and LOW pulse width)	t _{CKE}	MIN	max(7.5ns,3nCK)			ns
CKE input setup time	t _{ISCKE} ¹⁴	MIN	0.25			t _{CK(avg)}
CKE input hold time	t _{IHCKE} ¹⁵	MIN	0.25			t _{CK(avg)}
Command path disable delay	t _{CPDED}	MIN	2			t _{CK(avg)}
Command Address Input Parameters⁵						
Address and control input setup time	t _{ISCA} ¹⁶	MIN	150	130	115	ps
Address and control input hold time	t _{IHCA} ¹⁶	MIN	150	130	115	ps
CS_n input setup time	t _{ISCS} ¹⁶	MIN	270	230	205	ps
CS_n input hold time	t _{IHCS} ¹⁶	MIN	270	230	205	ps
Address and control input pulse width	t _{IPWCA}	MIN	0.35			t _{CK(avg)}
CS_n input pulse width	t _{IPWCS}	MIN	0.7			t _{CK(avg)}
Boot Parameters (10 MHz–55 MHz)^{17, 18, 19}						
Clock cycle time	t _{CKb}	MAX	100			nsns
		MIN	18			
CKE input setup time	t _{ISCKEb}	MIN	2.5			ns
CKE input hold time	t _{IHCKEb}	MIN	2.5			ns
Address and control input setup time	t _{ISb}	MIN	1150			ps

Parameter	Symbol	Min/ Max	Data Rate			Unit
			1600	1866	2133	
Address and control input hold time	t_{IHb}	MIN	1150			ps
DQS output data access time from CK_t/CK_c	t_{DQSCkb}	MIN	2.0			ns
		MAX	10.0			
Data strobe edge to output data edge	t_{DQSqb}	MAX	1.2			ns
Mode Register Parameters						
MODE REGISTER WRITE command period	t_{MRW}	MIN	10			$t_{CK(avg)}$
MODE REGISTER READ command period	t_{MRR}	MIN	4			$t_{CK(avg)}$
Additional time after t_{XP} has expired until MRR command may be issued	t_{MRRi}	MIN	$t_{RCD (MIN)}$			ns
Core Parameters²⁰						
READ latency	RL	MIN	12	14	16	$t_{CK(avg)}$
WRITE latency (set A)	WL	MIN	6	8	8	$t_{CK(avg)}$
WRITE latency (set B)	WL	MIN	9	11	13	$t_{CK(avg)}$
ACTIVATE-to- ACTIVATE command period	t_{RC}	MIN	$t_{RAS} + t_{RPab}$ (with all-bank precharge) $t_{RAS} + t_{RPpb}$ (with per-bank precharge)			ns
CKE minimum pulse width during SELF REFRESH (low pulse width during SELF REFRESH)	t_{CKESR}	MIN	max(15ns,3nCK)			ns
SELF REFRESH exit to next valid command delay	t_{XSR}	MIN	max($t_{RFCab} + 10ns, 2nCK$)			ns
Exit power-down to next valid command delay	t_{XP}	MIN	max(7.5ns,3nCK)			ns
CAS-to-CAS delay	t_{CCD}	MIN	4			$t_{CK(avg)}$
Internal READ to PRECHARGE command delay	t_{RTP}	MIN	max(7.5ns,4nCK)			ns
RAS-to-CAS delay	$t_{RCD} (fast)$	MIN	max(15ns,3nCK)			ns
	$t_{RCD} (typ)$		max(18ns,3nCK)			
	$t_{RCD} (slow)$		max(24ns,3nCK)			
Row precharge time (single bank)	$t_{RPpb} (fast)$	MIN	max(15ns,3nCK)			ns
	$t_{RPpb} (typ)$		max(18ns,3nCK)			
	$t_{RPpb} (slow)$		max(24ns,3nCK)			
Row precharge time (all banks)	$t_{RPpab} (fast)$	MIN	max(18ns,3nCK)			ns
	$t_{RPpab} (typ)$		max(21ns,3nCK)			
	$t_{RPpab} (slow)$		max(27ns,3nCK)			

Parameter	Symbol	Min/ Max	Data Rate			Unit
			1600	1866	2133	
Row active time	t_{RAS}	MIN	max(42ns, 3nCK)			ns
		MAX	min(70.2, 9 x RM x t_{REFI})			μ s
WRITE recovery time	t_{WR}	MIN	max(15ns, 4nCK)			ns
Internal WRITE-to-READ command delay	t_{WTR}	MIN	max(7.5ns, 4nCK)			ns
Active bank A to active bank B	t_{RRD}	MIN	max(10ns, 2nCK)			ns
Four-bank ACTIVATE window	t_{FAW}	MIN	max(50ns, 8nCK)			ns
Minimum deep power-down time	t_{DPD}	MIN	500			μ s
ODT Parameters						
Asynchronous R_{TT} turn-on delay from ODT input	t_{ODTon}	MIN	1.75			nsns
		MAX	3.5			
Asynchronous R_{TT} turn-off delay from ODT input	t_{ODToff}	MIN	1.75			nsns
		MAX	3.5			
Automatic R_{TT} turn-on delay after READ data	t_{AODTon}	MAX	$t_{DQSCk} + 1.4 \times t_{DQSQ,max} + t_{CK(avg,min)}$			ps
Automatic R_{TT} turn-off delay after READ data	$t_{AODToff}$	MIN	$t_{DQSCk,min} - 300$			ps
R_{TT} disable delay from power down entry	t_{ODTd}	MAX	12			ns
R_{TT} disable delay from self-refresh, and deep power down entry	t_{ODTd}	MAX	$12 + 0.5 t_{CK}$			ns
R_{TT} enable delay from power down and self refresh exit	t_{ODTe}	MAX	12			ns
CA Training Parameters						
First CA calibration command after CA calibration mode is programmed	t_{CAMRD}	MIN	20			$t_{CK(avg)}$
First CA calibration command after CKE is LOW	t_{CAENT}	MIN	10			$t_{CK(avg)}$
CA calibration exit command after CKE is HIGH	t_{CAEXT}	MIN	10			$t_{CK(avg)}$
CKE LOW after CA calibration mode is programmed	t_{CACKEL}	MIN	10			$t_{CK(avg)}$
CKE HIGH after the last CA calibration results are driven	t_{CACKEH}	MIN	10			$t_{CK(avg)}$
Data out delay after CA training calibration command is programmed	t_{ADR}	MAX	20			ns
MRW CA exit command to DQ tri-state	t_{MRZ}	MIN	3			ns

Parameter	Symbol	Min/ Max	Data Rate			Unit
			1600	1866	2133	
C A calibration command to CA calibration command delay	t_{CADC}	MIN	RU($t_{ADR}+2 \times t_{CK}$)			$t_{CK(ave)}$
Write Leveling Parameters						
DQS_t/DQS_c delay after write leveling mode is programmed	$t_{WLDQSEN}$	MIN	25			ns
		MAX	--			
First DQS_t/DQS_c edge after write leveling mode is programmed	t_{WLMRD}	MIN	40			nsns
		MAX	--			
Write leveling output delay	t_{WLO}	MIN	0			nsns
		MAX	20			
Write leveling hold time	t_{WLH}	MIN	175	150	135	ps
Write leveling setup time	t_{WLS}	MIN	175	150	135	ps
Mode register set command delay	t_{MRD}	MIN	max(14ns, 10nCK)			nsns
		MAX	--			
Temperature Derating¹⁹						
DQS output access time from CK_t/CK_c (derated)	t_{DQSCK}	MAX	5620			ps
RAS-to-CAS delay (derated)	t_{RCD}	MIN	$t_{RCD} + 1.875$			ns
ACTIVATE-to-ACTIVATE command period (derated)	t_{RC}	MIN	$t_{RC} + 1.875$			ns
Row active time (derated)	t_{RAS}	MIN	$t_{RAS} + 1.875$			ns
Row precharge time (derated)	t_{RP}	MIN	$t_{RP} + 1.875$			ns
Active bank A to active bank B (derated)	t_{RRD}	MIN	$t_{RRD} + 1.875$			ns

Note:

1. Frequency values are for reference only. Clock cycle time (t_{CK}) is used to determine device capabilities.
2. All AC timings assume an input slew rate of 2 V/ns for single ended signals.
3. Measured with 4 V/ns differential CK_t/CK_c slew rate and nominal V_{IX} .
4. All timing and voltage measurements are defined 'at the ball',
5. READ, WRITE, and input setup and hold values are referenced to V_{REF} .
6. t_{DQSKDS} is the absolute value of the difference between any two t_{DQSK} measurements (in a byte lane) within a contiguous sequence of bursts in a 160ns rolling window. t_{DQSKDS} is not tested and is guaranteed by design. Temperature drift in the system is $< 10\text{ }^{\circ}\text{C/s}$. Values do not include clock jitter.
7. t_{DQSKDM} is the absolute value of the difference between any two t_{DQSK} measurements (in a byte lane) within a 1.6 μs rolling window. t_{DQSKDM} is not tested and is guaranteed by design. Temperature drift in the system is $< 10\text{ }^{\circ}\text{C/s}$. Values do not include clock jitter.
8. t_{DQSKDL} is the absolute value of the difference between any two t_{DQSK} measurements (in a byte lane) within a 32ms rolling window. t_{DQSKDL} is not tested and is guaranteed by design. Temperature drift in the system is $< 10\text{ }^{\circ}\text{C/s}$. Values do not include clock jitter.
9. For LOW-to-HIGH and HIGH-to-LOW transitions, the timing reference is at the point when the signal crosses the transition threshold (V_{TT}). t_{HZ} and t_{LZ} transitions occur in the same access time (with respect to clock) as valid data transitions. These parameters are not referenced to a specific voltage level but to the time when the device output is no longer driving (for t_{RPST} , $t_{HZ(DQS)}$ and $t_{HZ(DQ)}$), or begins driving (for t_{RPRE} , $t_{LZ(DQS)}$, $t_{LZ(DQ)}$). Figure 10 shows a method to calculate the point when device is no longer driving $t_{HZ(DQS)}$ and $t_{HZ(DQ)}$, or begins driving $t_{LZ(DQS)}$, $t_{LZ(DQ)}$ by measuring the signal at two different voltages. The actual voltage measurement points are not critical as long as the calculation is consistent.
10. Output Transition Timing

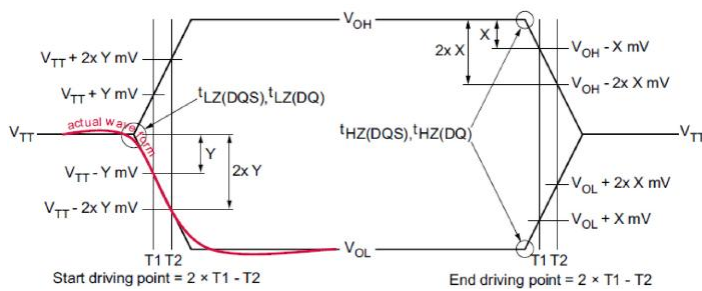

11. The parameters $t_{LZ(DQS)}$, $t_{LZ(DQ)}$, $t_{HZ(DQS)}$, and $t_{HZ(DQ)}$ are defined as single-ended. The timing parameters t_{RPST} and t_{RPST} are determined from the differential signal DQS/DQS#.
12. Measured from the point when DQS_t/DQS_c begins driving the signal to the point when DQS_t/DQS_c begins driving the first rising strobe edge.
13. Measured from the last falling strobe edge of DQS_t/DQS_c to the point when DQS_t/DQS_c finishes driving the signal.
14. CKE input setup time is measured from CKE reaching a HIGH/LOW voltage level to CK_t/CK_c crossing.
15. CKE input hold time is measured from CK_t/CK_c crossing to CKE reaching a HIGH/LOW voltage level.
16. Input set-up/hold time for signal (CA[9:0], CS_n).
17. To ensure device operation before the device is configured, a number of AC boot-timing parameters are defined in this table. Boot parameter symbols have the letter b appended (for example, t_{CK} during boot is t_{CKb}).
18. The LPDDR3 device will set some mode register default values upon receiving a RESET (MRW) command as specified in "Mode Register Definition".
19. The output skew parameters are measured with default output impedance settings using the reference load.
20. The minimum t_{CK} column applies only when t_{CK} is greater than 6ns.

CA and CS_n Setup, Hold and Derating

For all input signals (CA and CS_n) the total t_{IS} (setup time) and t_{IH} (hold time) required is calculated by adding the data sheet $t_{IS}(\text{base})$ and $t_{IH}(\text{base})$ value (see CA Setup and Hold Base-Values table) to the Δt_{IS} and Δt_{IH} derating value (see Derating values t_{IS}/t_{IH} - ac/dc based AC150 table) respectively.

Example: t_{IS} (total setup time) = $t_{IS}(\text{base}) + \Delta t_{IS}$.

Setup (t_{IS}) nominal slew rate for a rising signal is defined as the slew rate between the last crossing of $V_{REF(dc)}$ and the first crossing of $V_{IH(ac)min}$. Setup (t_{IS}) nominal slew rate for a falling signal is defined as the slew rate between the last crossing of $V_{REF(dc)}$ and the first crossing of $V_{IL(ac)max}$. If the actual signal is always earlier than the nominal slew rate line between shaded ' $V_{REF(dc)}$ to ac region', use nominal slew rate for derating value (see Illustration of nominal slew rate and t_{VAC} for setup time t_{IS} for CA and CS_n with respect to clock figure). If the actual signal is later than the nominal slew rate line anywhere between shaded ' $V_{REF(dc)}$ to ac region', the slew rate of a tangent line to the actual signal from the ac level to dc level is used for derating value (see Illustration of tangent line for setup time t_{IS} for CA and CS_n with respect to clock figure).

Hold (t_{IH}) nominal slew rate for a rising signal is defined as the slew rate between the last crossing of $V_{IL(dc)max}$ and the first crossing of $V_{REF(dc)}$. Hold (t_{IH}) nominal slew rate for a falling signal is defined as the slew rate between the last crossing of $V_{IH(dc)min}$ and the first crossing of $V_{REF(dc)}$. If the actual signal is always later than the nominal slew rate line between shaded 'dc to $V_{REF(dc)}$ region', use nominal slew rate for derating value (see Illustration of nominal slew rate for hold time t_{IH} for CA and CS_n with respect to clock figure). If the actual signal is earlier than the nominal slew rate line anywhere between shaded 'dc to $V_{REF(dc)}$ region', the slew rate of a tangent line to the actual signal from the dc level to $V_{REF(dc)}$ level is used for derating value (see Illustration of tangent line for for hold time t_{IH} for CA and CS_n with respect to clock figure).

For a valid transition the input signal has to remain above/below $V_{IH/IL(ac)}$ for some time t_{VAC} (see Required time t_{VAC} above $V_{IH(ac)}$ (below $V_{IL(ac)}$) for valid transition for CA table).

Although for slow slew rates the total setup time might be negative (i.e. a valid input signal will not have reached $V_{H/IL(ac)}$ at the time of the rising clock transition) a valid input signal is still required to complete the transition and reach $V_{H/IL(ac)}$.

For slew rates in between the values listed in Derating values t_{IS}/t_{IH} - ac/dc based AC150 table, the derating values may obtained by linear interpolation.

These values are typically not subject to production test. They are verified by design and characterization.

CA Setup and Hold Base-Values

[ps]	Data Rate			reference
	1600	1866	2133	
$t_{ISCA}(\text{base})$	75	-	-	$V_{IH/L(ac)} = V_{REF(dc)} \pm 150\text{mV}$
$t_{ISCA}(\text{base})$	-	62.5	47.5	$V_{IH/L(ac)} = V_{REF(dc)} \pm 135\text{mV}$
$t_{IHCA}(\text{base})$	100	80	65	$V_{IH/L(dc)} = V_{REF(dc)} \pm 100\text{mV}$

Note: 1. ac/dc referenced for 2V/ns CA slew rate and 4V/ns differential CK_t/CK_c slew rate.

CS_n Setup and Hold Base-Values

[ps]	Data Rate			reference
	1600	1866	2133	
$t_{ISCS}(\text{base})$	195	-	-	$V_{IH/L(ac)} = V_{REF(dc)} \pm 150\text{mV}$
$t_{ISCS}(\text{base})$	-	162.5	137.5	$V_{IH/L(ac)} = V_{REF(dc)} \pm 135\text{mV}$
$t_{IHCS}(\text{base})$	220	180	155	$V_{IH/L(dc)} = V_{REF(dc)} \pm 100\text{mV}$

Note: 1. AC/DC referenced for 2V/ns CS_n slew rate and 4V/ns differential CK_t/CK_c slew rate.

Derating values t_{IS}/t_{IH} - ac/dc based AC150

$\Delta t_{ISCA}, \Delta t_{IHCA}, \Delta t_{ISCS}, \Delta t_{IHCS}$ derating in [ps] AC/DC based AC150 Threshold -> $V_{IH(ac)}=V_{REF(dc)}+150mV, V_{IL(ac)}=V_{REF(dc)}-150mV$ DC100 Threshold -> $V_{IH(dc)}=V_{REF(dc)}+100mV, V_{IL(dc)}=V_{REF(dc)}-100mV$													
		CK_t, CK_c Differential Slew Rate											
		8.0 V/ns		7.0 V/ns		6.0 V/ns		5.0 V/ns		4.0 V/ns		3.0 V/ns	
		Δt_{IS}	Δt_{IH}	Δt_{IS}	Δt_{IH}	Δt_{IS}	Δt_{IH}	Δt_{IS}	Δt_{IH}	Δt_{IS}	Δt_{IH}	Δt_{IS}	Δt_{IH}
CA, CS_n Slew rate V/ns	4.0	38	25	38	25	38	25	38	25	38	25	-	-
	3.0	-	-	25	17	25	17	25	17	25	17	38	29
	2.0	-	-	-	-	0	0	0	0	0	0	13	13
	1.5	-	-	-	-	-	-	-25	-17	-25	-17	-12	-4

Note: 1. Cell contents shaded in red are defined as 'not supported'.

Derating values t_{IS}/t_{IH} - ac/dc based AC135

$\Delta t_{ISCA}, \Delta t_{IHCA}, \Delta t_{ISCS}, \Delta t_{IHCS}$ derating in [ps] AC/DC based AC135 Threshold -> $V_{IH(ac)}=V_{REF(dc)}+135mV, V_{IL(ac)}=V_{REF(dc)}-135mV$ DC100 Threshold -> $V_{IH(dc)}=V_{REF(dc)}+100mV, V_{IL(dc)}=V_{REF(dc)}-100mV$													
		CK_t, CK_c Differential Slew Rate											
		8.0 V/ns		7.0 V/ns		6.0 V/ns		5.0 V/ns		4.0 V/ns		3.0 V/ns	
		Δt_{IS}	Δt_{IH}	Δt_{IS}	Δt_{IH}	Δt_{IS}	Δt_{IH}	Δt_{IS}	Δt_{IH}	Δt_{IS}	Δt_{IH}	Δt_{IS}	Δt_{IH}
CA, CS_n Slew rate V/ns	4.0	34	25	34	25	34	25	34	25	34	25	-	-
	3.0	-	-	23	17	23	17	23	17	23	17	34	29
	2.0	-	-	-	-	0	0	0	0	0	0	11	13
	1.5	-	-	-	-	-	-	-23	-17	-23	-17	-12	-4

Note: 1. Cell contents shaded in red are defined as 'not supported'.

Required time t_{VAC} above $V_{IH(ac)}$ {below $V_{IL(ac)}$ } for valid transition for CA

Slew Rate [V/ns]	t_{VAC} [ps] @ 150mV 1600Mbps		t_{VAC} [ps] @ 135mV 1866Mbps		t_{VAC} [ps] @ 135mV 2133Mbps	
	min	max	min	max	min	max
> 4.0	48	-	40	-	34	-
4.0	48	-	40	-	34	-
3.5	46	-	39	-	33	-
3.0	43	-	36	-	30	-
2.5	40	-	33	-	27	-
2.0	35	-	29	-	23	-
1.5	27	-	21	-	15	-
< 1.5	27	-	21	-	15	-

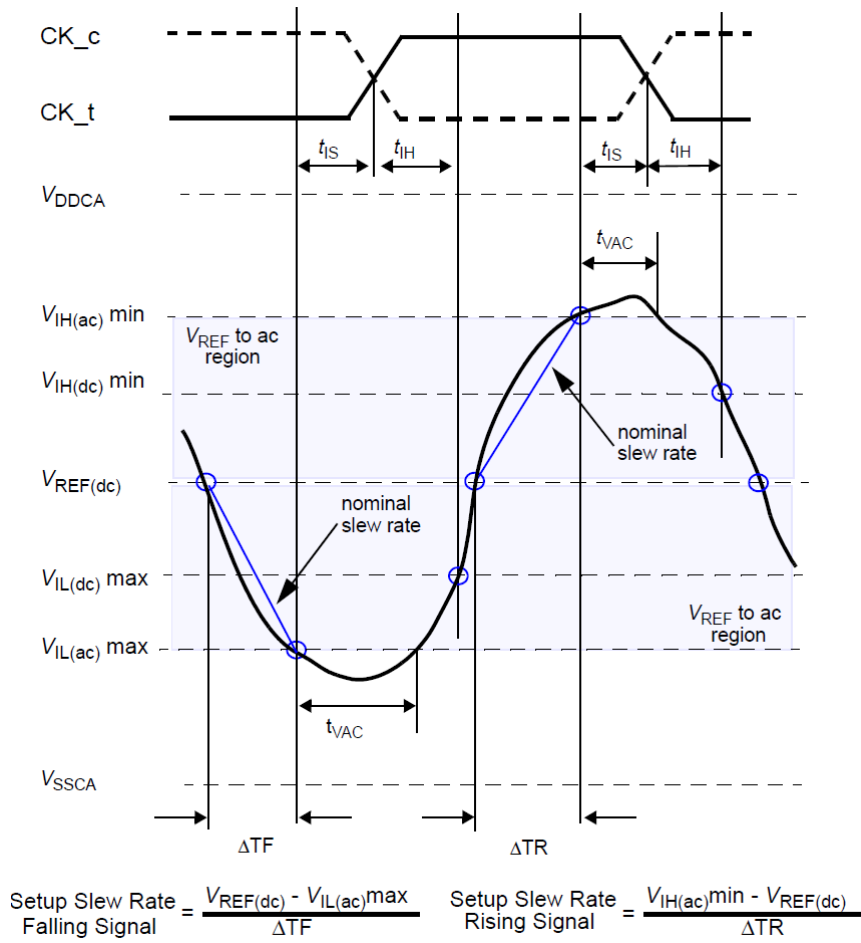

Illustration of nominal slew rate and t_{VAC} for setup time t_{IS} for CA and CS_n with respect to clock.

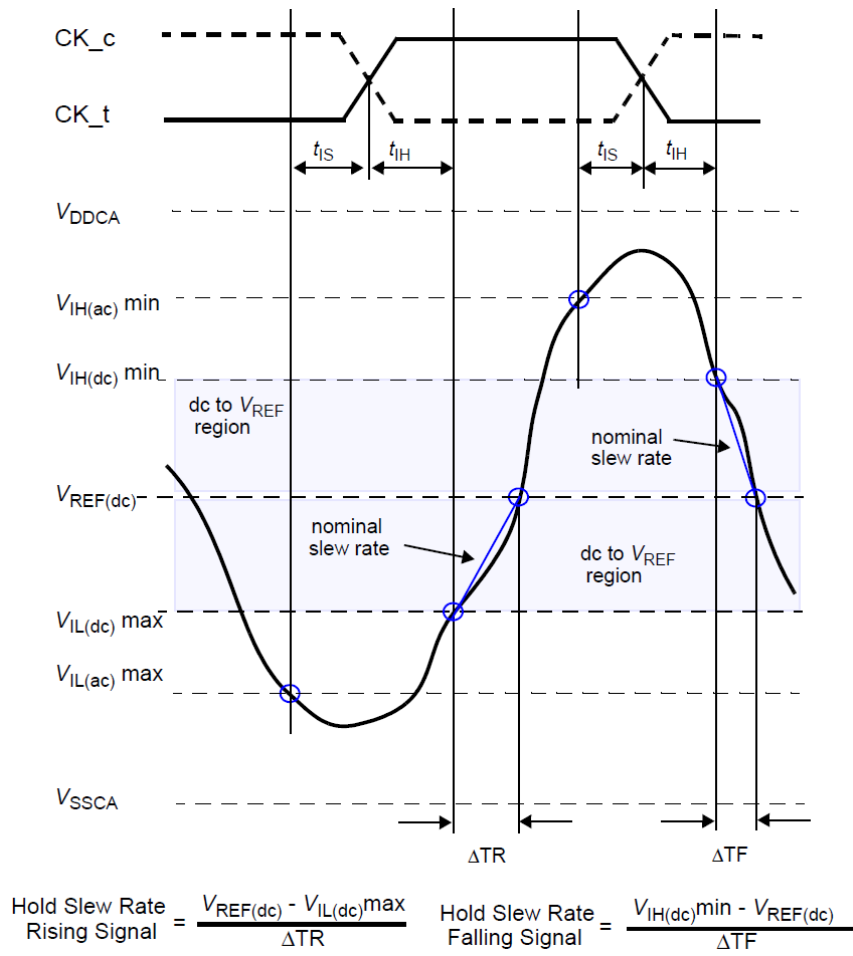

Illustration of nominal slew rate for hold time t_{IH} for CA and CS_n with respect to clock

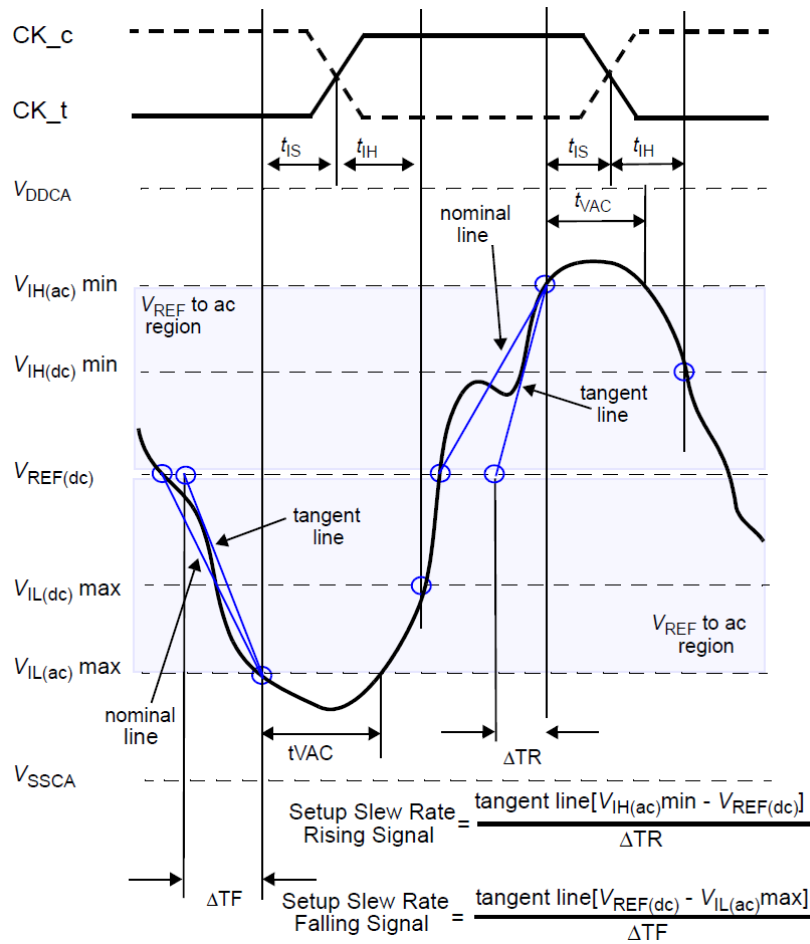

Illustration of tangent line for setup time t_{IS} for CA and CS_n with respect to clock

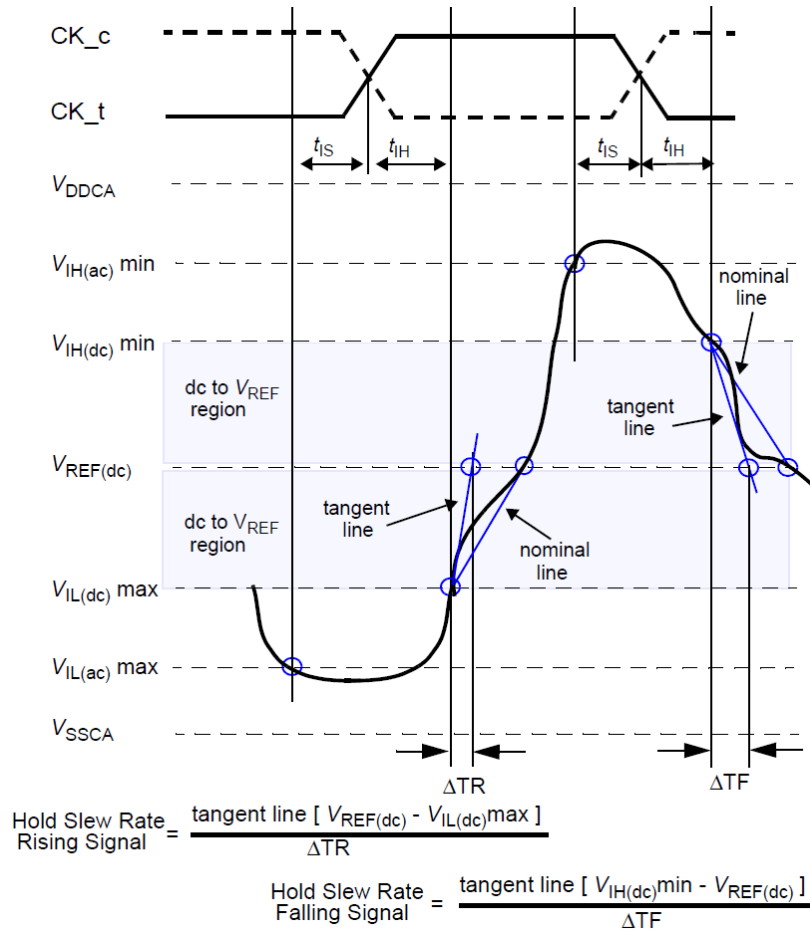

Illustration of tangent line for for hold time t_{IH} for CA and CS_n with respect to clock

Data Setup, Hold and Slew Rate Derating

For all input signals (DQ, DM) the total t_{DS} (setup time) and t_{DH} (hold time) required is calculated by adding the data sheet $t_{DS}(\text{base})$ and $t_{DH}(\text{base})$ value (see Data Setup and Hold Base-Values table) to the Δt_{DS} and Δt_{DH} (see Derating values t_{IS}/t_{IH} - ac/dc based AC150 table) derating value respectively.

Example: $t_{DS}(\text{total setup time}) = t_{DS}(\text{base}) + \Delta t_{DS}$.

Setup (t_{DS}) nominal slew rate for a rising signal is defined as the slew rate between the last crossing of $V_{REF(dc)}$ and the first crossing of $V_{IH(ac)min}$. Setup (t_{DS}) nominal slew rate for a falling signal is defined as the slew rate between the last crossing of $V_{REF(dc)}$ and the first crossing of $V_{IL(ac)max}$ (see Illustration of nominal slew rate and t_{VAC} for setup time t_{DS} for DQ with respect to strobe figure). If the actual signal is always earlier than the nominal slew rate line between shaded 'V_{REF(dc)} to ac region', use nominal slew rate for derating value. If the actual signal is later than the nominal slew rate line anywhere between shaded 'V_{REF(dc)} to ac region', the slew rate of a tangent line to the actual signal from the ac level to dc level is used for derating value (see Illustration of tangent line for setup time t_{DS} for DQ with respect to strobe figure).

Hold (t_{DH}) nominal slew rate for a rising signal is defined as the slew rate between the last crossing of $V_{IL(dc)max}$ and the first crossing of $V_{REF(dc)}$. Hold (t_{DH}) nominal slew rate for a falling signal is defined as the slew rate between the last crossing of $V_{IH(dc)min}$ and the first crossing of $V_{REF(dc)}$ (see Illustration of nominal slew rate for hold time t_{DH} for DQ with respect to strobe figure). If the actual signal is always later than the nominal slew rate line between shaded 'dc level to V_{REF(dc)} region', use nominal slew rate for derating value. If the actual signal is earlier than the nominal slew rate line anywhere between shaded 'dc to V_{REF(dc)} region', the slew rate of a tangent line to the actual signal from the dc level to V_{REF(dc)} level is used for derating value.

For a valid transition the input signal has to remain above/below $V_{IH/IL(ac)}$ for some time t_{VAC} (see Allowed time before ringback t_{DVAC} for DQS_t/DQS_c table).

Although for slow slew rates the total setup time might be negative (i.e. a valid input signal will not have reached $V_{IH/IL(ac)}$ at the time of the rising clock transition) a valid input signal is still required to complete the transition and reach $V_{IH/IL(ac)}$.

For slew rates in between the values listed in the tables the derating values may obtained by linear interpolation.

These values are typically not subject to production test. They are verified by design and characterization.

Data Setup and Hold Base-Values

[ps]	Data Rate			reference
	1600	1866	2133	
$t_{DS}(\text{base})$	75	-	-	$V_{IH/IL(ac)} = V_{REF(dc)} \pm 150\text{mV}$
$t_{DS}(\text{base})$	-	62.5	47.5	$V_{IH/IL(ac)} = V_{REF(dc)} \pm 135\text{mV}$
$t_{DH}(\text{base})$	100	80	65	$V_{IH/IL(dc)} = V_{REF(dc)} \pm 100\text{mV}$

Note: 1. AC/DC referenced for 2V/ns DQ, DM slew rate and 4V/ns differential DQS_t/DQS_c slew rate and nominal V_{IX} .

Derating values LPDDR3 t_{DS}/t_{DH} - ac/dc based AC150

$\Delta t_{DS}, \Delta t_{DH}$ derating in [ps] AC/DC based AC150 Threshold -> $V_{IH(ac)}=V_{REF(dc)}+150mV, V_{IL(ac)}=V_{REF(dc)}-150mV$ DC100 Threshold -> $V_{IH(dc)}=V_{REF(dc)}+100mV, V_{IL(dc)}=V_{REF(dc)}-100mV$													
		DQS_t, DQS_c Differential Slew Rate											
		8.0 V/ns		7.0 V/ns		6.0 V/ns		5.0 V/ns		4.0 V/ns		3.0 V/ns	
		Δt_{DS}	Δt_{DH}	Δt_{DS}	Δt_{DH}	Δt_{DS}	Δt_{DH}	Δt_{DS}	Δt_{DH}	Δt_{DS}	Δt_{DH}	Δt_{DS}	Δt_{DH}
DQ, DM Slew rate V/ns	4.0	38	25	38	25	38	25	38	25	38	25	-	-
	3.0	-	-	25	17	25	17	25	17	25	17	38	29
	2.0	-	-	-	-	0	0	0	0	0	0	13	13
	1.5	-	-	-	-	-	-	-25	-17	-25	-17	-12	-4

Note: 1. Cell contents shaded in red are defined as 'not supported'.

Derating values LPDDR3 t_{DS}/t_{DH} - ac/dc based AC135

$\Delta t_{DS}, \Delta t_{DH}$ derating in [ps] AC/DC based AC135 Threshold -> $V_{IH(ac)}=V_{REF(dc)}+135mV, V_{IL(ac)}=V_{REF(dc)}-135mV$ DC100 Threshold -> $V_{IH(dc)}=V_{REF(dc)}+100mV, V_{IL(dc)}=V_{REF(dc)}-100mV$													
		DQS_t, DQS_c Differential Slew Rate											
		8.0 V/ns		7.0 V/ns		6.0 V/ns		5.0 V/ns		4.0 V/ns		3.0 V/ns	
		Δt_{DS}	Δt_{DH}	Δt_{DS}	Δt_{DH}	Δt_{DS}	Δt_{DH}	Δt_{DS}	Δt_{DH}	Δt_{DS}	Δt_{DH}	Δt_{DS}	Δt_{DH}
DQ, DM Slew rate V/ns	4.0	34	25	34	25	34	25	34	25	34	25	-	-
	3.0	-	-	23	17	23	17	23	17	23	17	34	29
	2.0	-	-	-	-	0	0	0	0	0	0	11	13
	1.5	-	-	-	-	-	-	-23	-17	-23	-17	-12	-4

Note: 1. Cell contents shaded in red are defined as 'not supported'.

Required time t_{VAC} above $V_{IH(ac)}$ {below $V_{IL(ac)}$ } for valid transition for DQ, DM

Slew Rate [V/ns]	t_{VAC} [ps] @ 150mV 1600Mbps		t_{VAC} [ps] @ 135mV 1866Mbps		t_{VAC} [ps] @ 135mV 2133Mbps	
	min	max	min	max	min	max
> 4.0	48	-	40	-	34	-
4.0	48	-	40	-	34	-
3.5	46	-	39	-	33	-
3.0	43	-	36	-	30	-
2.5	40	-	33	-	27	-
2.0	35	-	29	-	23	-
1.5	27	-	21	-	15	-
< 1.5	27	-	21	-	15	-

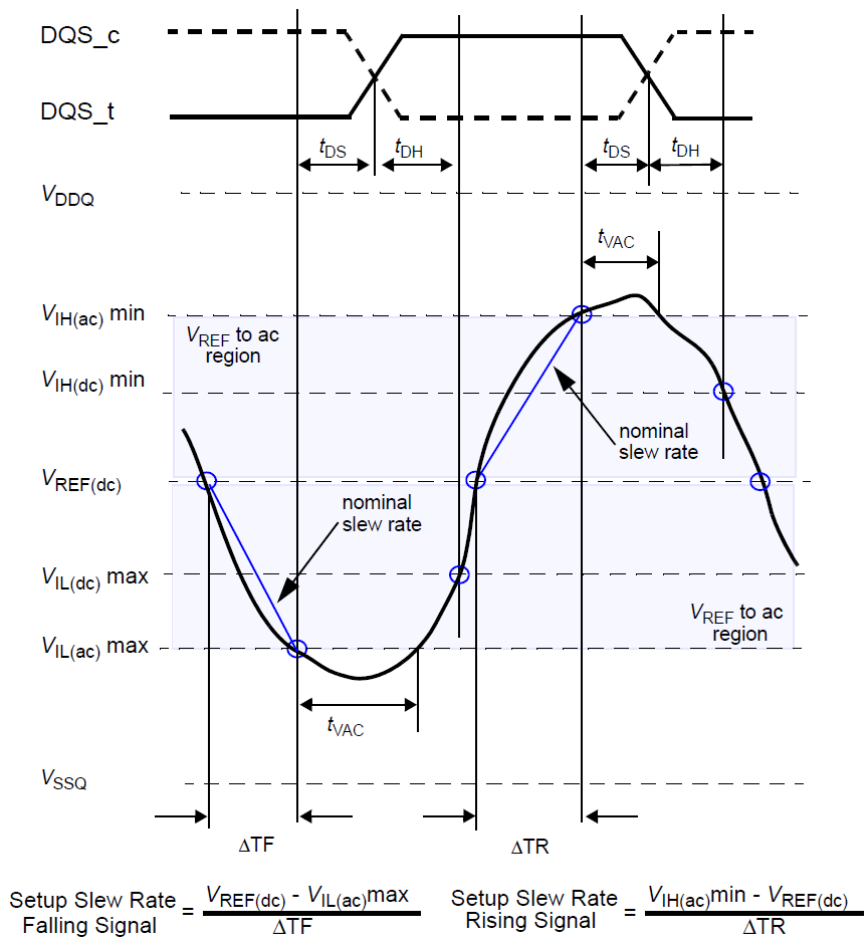

Illustration of nominal slew rate and t_{VAC} for setup time t_{DS} for DQ with respect to strobe

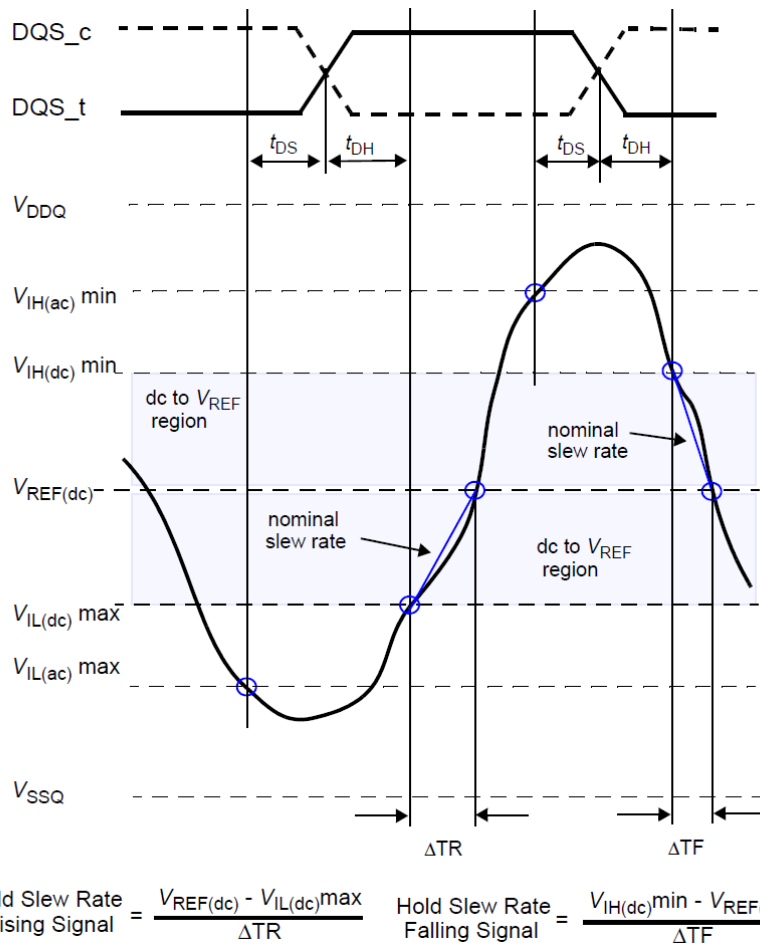

Illustration of nominal slew rate for hold time t_{DH} for DQ with respect to strobe

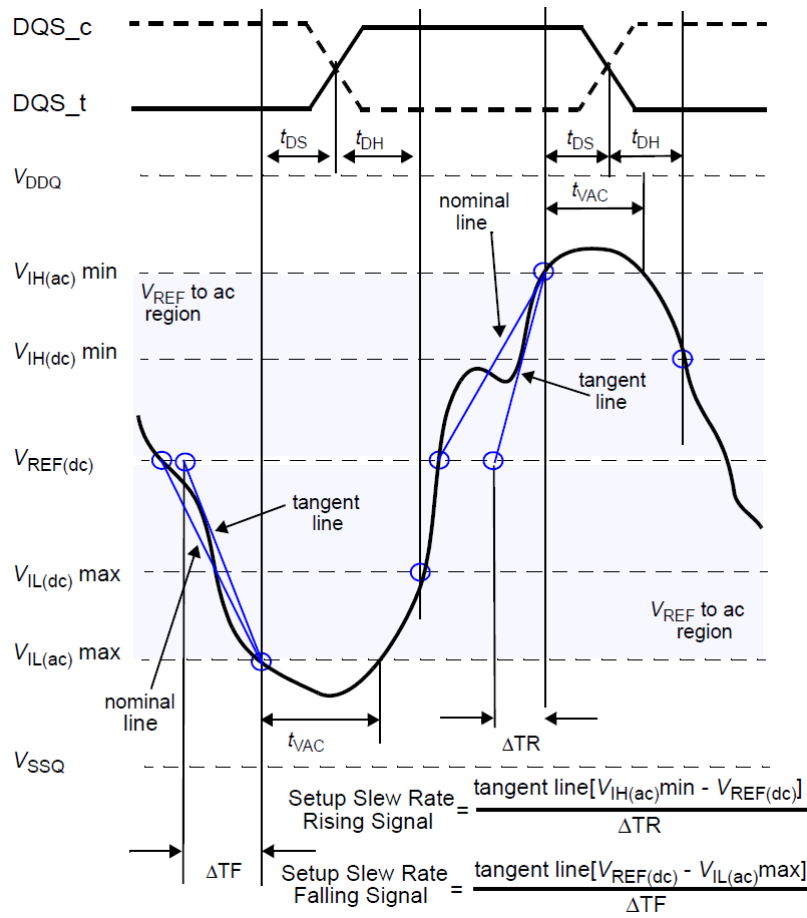

Illustration of tangent line for setup time t_{DS} for DQ with respect to strobe

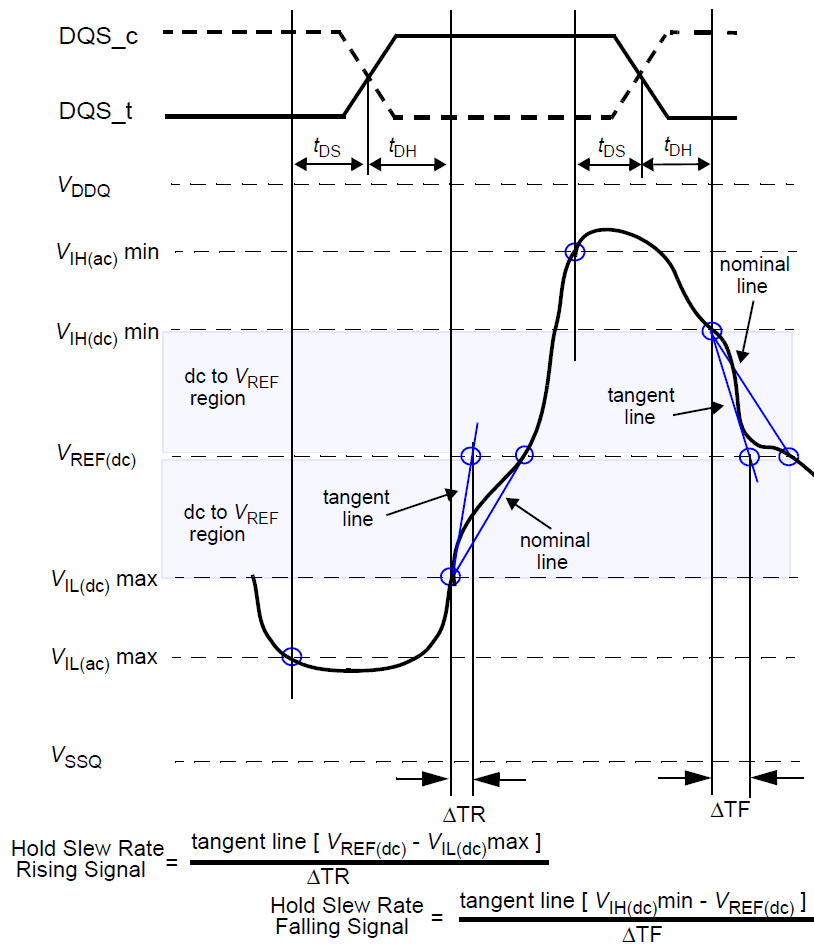

Illustration of tangent line for for hold time t_{DH} for DQ with respect to strobe

PACKING

DIMENSIONS

178-BALL

(11x11.5 mm)

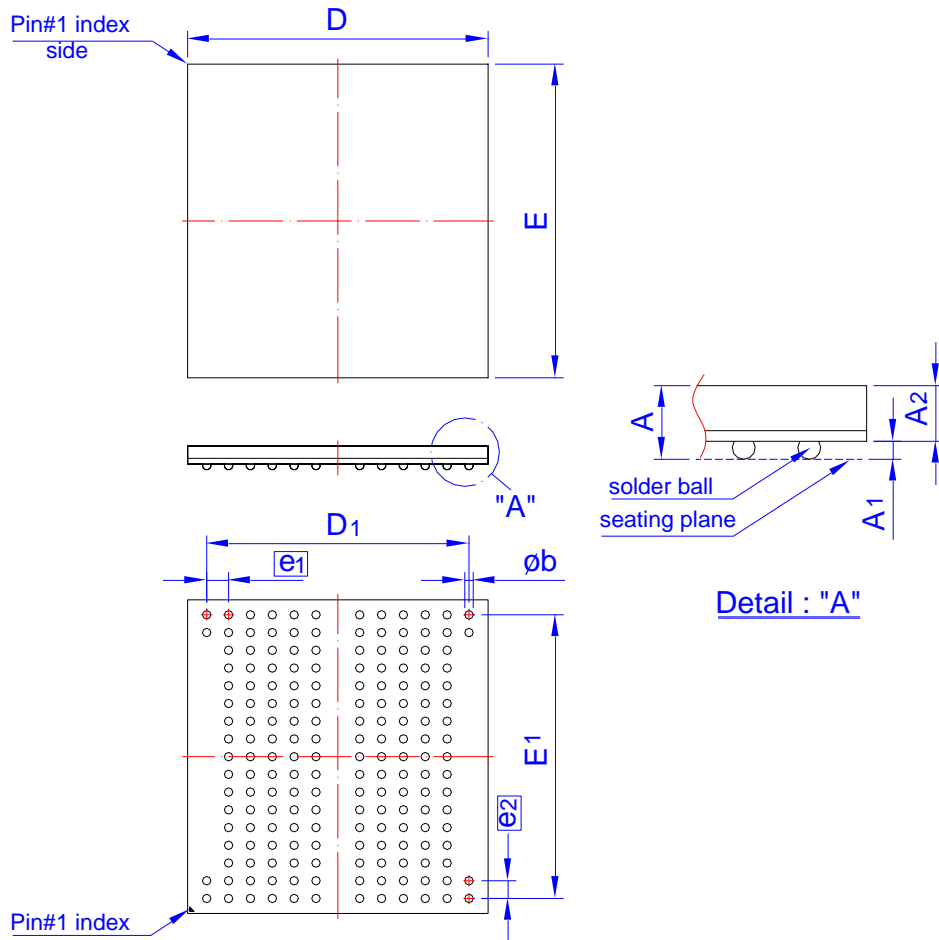

Symbol	Dimension in mm			Dimension in inch		
	Min	Norm	Max	Min	Norm	Max
A	---	---	1.00	---	---	0.039
A ₁	0.16	---	0.28	0.006	---	0.011
A ₂	0.61	---	0.71	0.024	---	0.028
Φ_b	0.25	0.31	0.36	0.010	0.012	0.014
D	10.90	11.00	11.10	0.429	0.433	0.437
E	11.40	11.50	11.60	0.449	0.453	0.457
D ₁	9.60 BSC			0.378 BSC		
E ₁	10.40 BSC			0.409 BSC		
e_1	0.80 BSC			0.031 BSC		
e_2	0.65 BSC			0.026 BSC		

Controlling dimension: Millimeter.
(Revision date: Nov. 17. 2021)

Revision History

Revision	Date	Description
0.1	2023.09.01	Original
0.2	2023.09.27	1. Modify the specification of IDD 2. Add Elevated Temperature range
1.0	2024.03.22	Modify: Version upgrade / IDD spec

Important Notice

All rights reserved.

No part of this document may be reproduced or duplicated in any form or by any means without the prior permission of ESMT.

The contents contained in this document are believed to be accurate at the time of publication. ESMT assumes no responsibility for any error in this document, and reserves the right to change the products or specification in this document without notice.

The information contained herein is presented only as a guide or examples for the application of our products. No responsibility is assumed by ESMT for any infringement of patents, copyrights, or other intellectual property rights of third parties which may result from its use. No license, either express, implied or otherwise, is granted under any patents, copyrights or other intellectual property rights of ESMT or others.

Any semiconductor devices may have inherently a certain rate of failure. To minimize risks associated with customer's application, adequate design and operating safeguards against injury, damage, or loss from such failure, should be provided by the customer when making application designs.

ESMT's products are not authorized for use in critical applications such as, but not limited to, life support devices or system, where failure or abnormal operation may directly affect human lives or cause physical injury or property damage. If products described here are to be used for such kinds of application, purchaser must do its own quality assurance testing appropriate to such applications.