

### 4 PIN DIP ZERO-CROSS TRIAC DRIVER PHOTOCOUPLER ELT304X, ELT306X, ELT308X Series

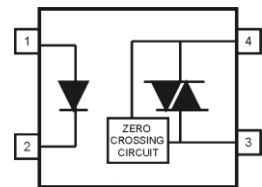

Schematic



Pin Configuration

1. Anode
2. Cathode
3. Terminal
4. Terminal

#### Features:

- Compliance Halogens Free (Br < 900 ppm, Cl < 900 ppm, Br+Cl < 1500 ppm)
- Peak breakdown voltage
  - 400V: ELT304X
  - 600V: ELT306X
  - 800V: ELT308X
- High isolation voltage between input and output (Viso=5000 V rms )
- Zero voltage crossing
  - The product itself will remain within RoHS compliant version
  - Compliance with EU REACH
- UL and cUL approved(No. E214129)
- VDE approved
- SEMKO approved
- NEMKO approved
- DEMKO approved
- FIMKO approved
- CQC approved

#### Description

The ELT304X, ELT306X and ELT308X series of devices each consist of a GaAs infrared emitting diode optically coupled to a monolithic silicon zero voltage crossing photo triac. They are designed for use with a discrete power triac in the interface of logic systems to equipment powered from 110 to 380 VAC lines, such as solid-state relays, industrial controls, motors, solenoids and consumer appliances.

#### Applications

- Solenoid/valve controls
- Light controls
- Static power switch
- AC motor drivers
- E.M. contactors
- Temperature controls

- AC Motor starters

**Absolute Maximum Ratings (Ta=25°C)**

Parameter		Symbol	Rating	Unit
Input	Forward current	$I_F$	60	mA
	Reverse voltage	$V_R$	6	V
	Power dissipation	$P_D$	100	mW
Output	Off-state Output Terminal Voltage	ELT304X	400	V
		ELT306X	600	
		ELT308X	800	
	Peak Repetitive Surge Current	$I_{TSM}$	1	A
	Power dissipation	$P_C$	300	mW
Total power dissipation		$P_{TOT}$	330	mW
Isolation voltage <sup>*1</sup>		$V_{ISO}$	5000	Vrms
Operating temperature		$T_{OPR}$	-55 to 100	°C
Storage temperature		$T_{STG}$	-55 to 125	°C
Soldering Temperature <sup>*2</sup>		$T_{SOL}$	260	°C

Notes:

\*1 AC for 1 minute, R.H.= 40 ~ 60% R.H. In this test, pins 1 & 2 are shorted together, and pins 3 & 4 are shorted together.

\*2 For 10 seconds

**Electro-Optical Characteristics (Ta=25°C unless specified otherwise)**

**Input**

Parameter	Symbol	Min.	Typ.*	Max.	Unit	Condition
Forward Voltage	$V_F$	-	-	1.5	V	$I_F = 30\text{mA}$
Reverse Leakage current	$I_R$	-	-	10	$\mu\text{A}$	$V_R = 6\text{V}$

**Output**

Parameter	Symbol	Min.	Typ.*	Max.	Unit	Condition
Peak Blocking Current	$I_{\text{DRM}}$	-	-	100 500	nA	$V_{\text{DRM}} = \text{Rated } V_{\text{DRM}}$ $I_F = 0\text{mA}$
Peak On-state Voltage	$V_{\text{TM}}$	-	-	3	V	$I_{\text{TM}} = 100\text{mA peak}$ , $I_F = \text{Rated } I_{\text{FT}}$
Critical Rate of Rise off-state Voltage	$dv/dt$	1000 600	-	-	V/ $\mu\text{s}$	$V_{\text{PEAK}} = \text{Rated } V_{\text{DRM}}$ , $I_F = 0$ (Fig. 10)
Inhibit Voltage (MT1-MT2 voltage above which device will not trigger)	$V_{\text{INH}}$	-	-	20	V	$I_F = \text{Rated } I_{\text{FT}}$
Leakage in Inhibited State	$I_{\text{DRM2}}$	-	-	500	$\mu\text{A}$	$I_F = \text{Rated } I_{\text{FT}}$ , $V_{\text{DRM}} = \text{Rated } V_{\text{DRM}}$ , off state

**Transfer Characteristics**

Parameter	Symbol	Min.	Typ.*	Max.	Unit	Condition
LED Trigger Current	$I_{\text{FT}}$	-	-	15 10 5	mA	Main terminal Voltage=3V
Holding Current	$I_H$	-	280	-	$\mu\text{A}$	

\* Typical values at  $T_a = 25^\circ\text{C}$

Typical Electro-Optical Characteristics Curves

Figure 1. Forward Current vs Forward Voltage

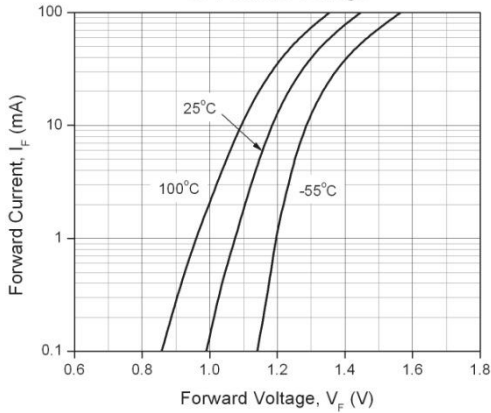

Figure 2. On-State Characteristics

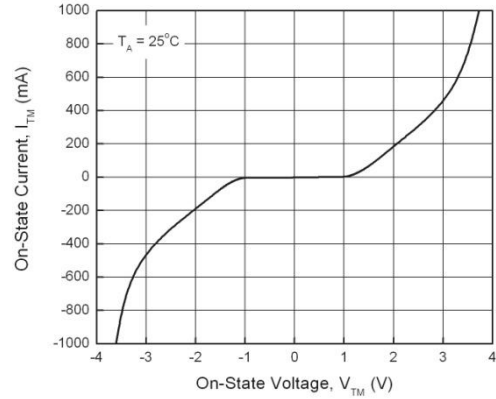

Figure 3. Holding Current vs. Ambient Temperature

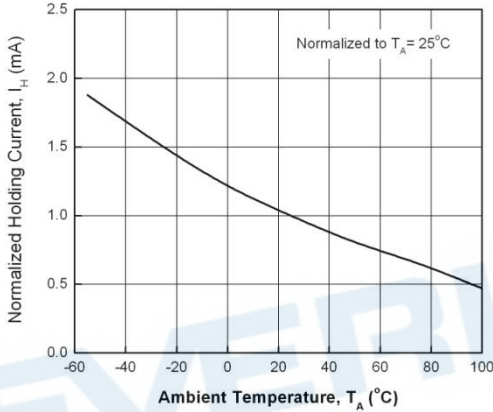

Figure 4. LED Current Required to Trigger vs. LED Pulse Width

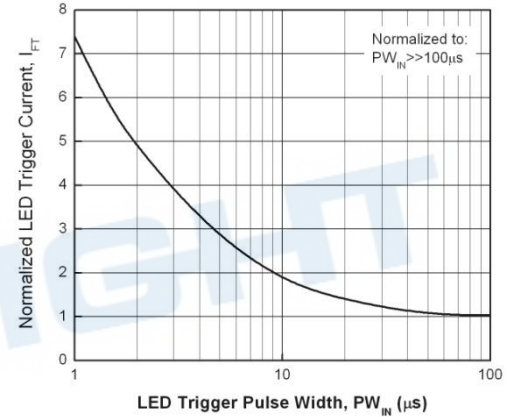

Figure 5. Leakage Current vs. Ambient Temperature

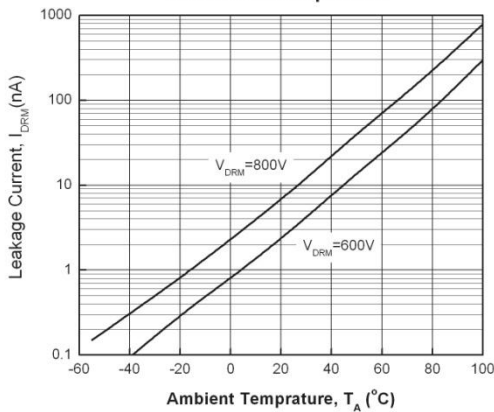

Figure 6. LED Trigger Current vs. Ambient Temperature

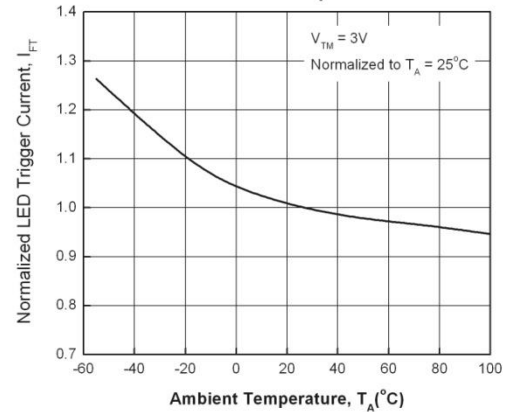

Figure 7. Off-State Output Terminal Voltage vs. Ambient Temperature

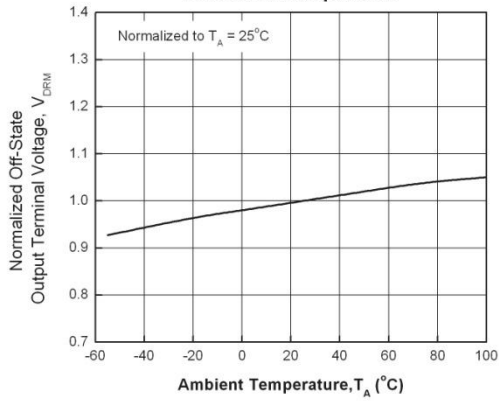

Figure 8. Leakage in Inhibit State vs. Ambient Temperature

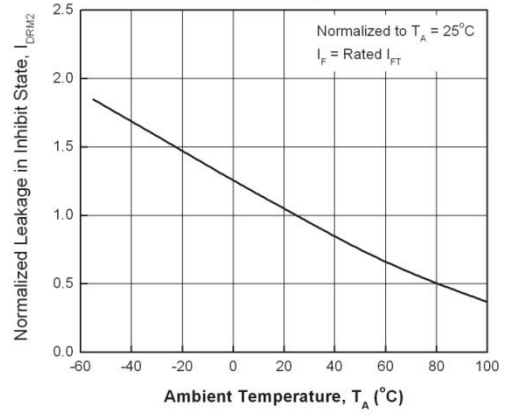

Figure 9. Inhibit Voltage vs. Ambient Temperature

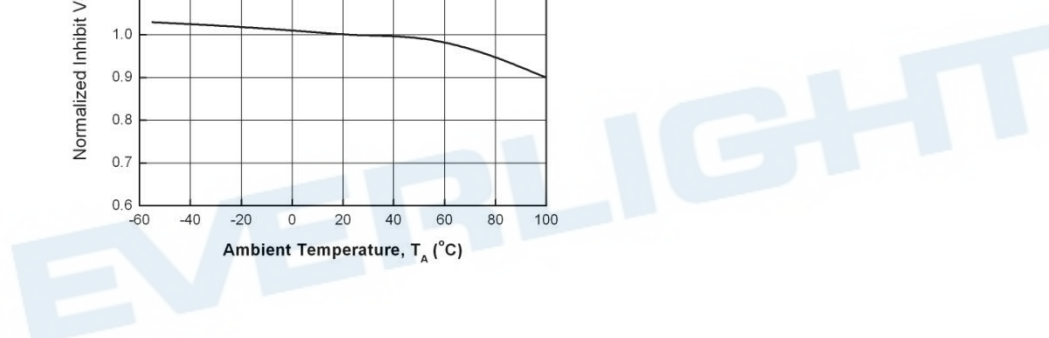
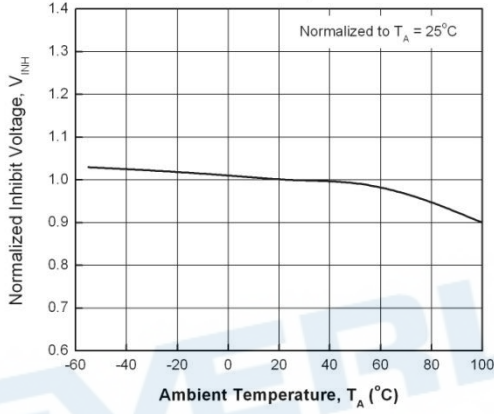
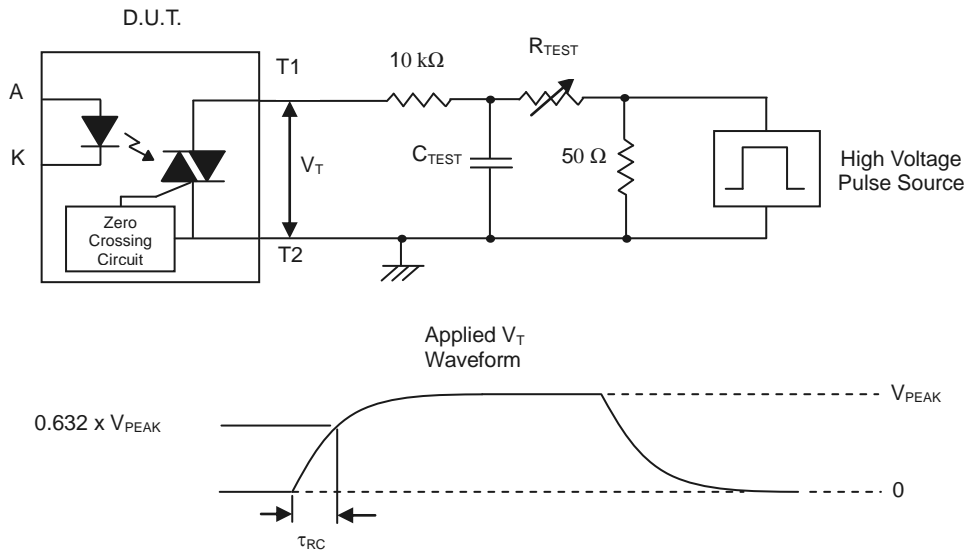

Figure 10. Static dv/dt Test Circuit & Waveform



### Measurement Method

The high voltage pulse is set to the required  $V_{PEAK}$  value and applied to the D.U.T. output side through the RC circuit above. LED current is not applied. The waveform  $V_T$  is monitored using a x100 scope probe. By varying  $R_{TEST}$ , the  $dv/dt$  (slope) is increased, until the D.U.T. is observed to trigger (waveform collapses). The  $dv/dt$  is then decreased until the D.U.T. stops triggering. At this point,  $\tau_{RC}$  is recorded and the  $dv/dt$  calculated.

$$dv/dt = \frac{0.632 \times V_{PEAK}}{\tau_{RC}}$$

For example,  $V_{PEAK} = 600V$  for ELT306X series. The  $dv/dt$  value is calculated as follows:

$$dv/dt = \frac{0.63 \times 600}{\tau_{RC}} = \frac{378}{\tau_{RC}}$$

**Order Information**

**Part Number**

**ELT304X(Y)(Z)-V**  
 or **ELT306X(Y)(Z)-V**  
 or **ELT308X(Y)(Z)-V**

**Note**

Note

X = Part No. (1, 2, or 3)  
 Y = Lead form option (S, S1, M or none)  
 Z = Tape and reel option (TA, TB, TU, TD or none).  
 V = VDE safety approved option

Option	Description	Packing quantity
None	Standard DIP-4	100 units per tube
M	Wide lead bend (0.4 inch spacing)	100 units per tube
S (TA)	Surface mount lead form + TA tape & reel option	1000 units per reel
S (TB)	Surface mount lead form + TB tape & reel option	1000 units per reel
S1 (TA)	Surface mount lead form (low profile) + TA tape & reel option	1000 units per reel
S1 (TB)	Surface mount lead form (low profile) + TB tape & reel option	1000 units per reel
S (TU)	Surface mount lead form + TU tape & reel option	1500 units per reel
S (TD)	Surface mount lead form + TD tape & reel option	1500 units per reel
S1 (TU)	Surface mount lead form (low profile) + TU tape & reel option	1500 units per reel
S1 (TD)	Surface mount lead form (low profile) + TD tape & reel option	1500 units per reel

### Package Dimension (Dimensions in mm)

#### Standard DIP Type

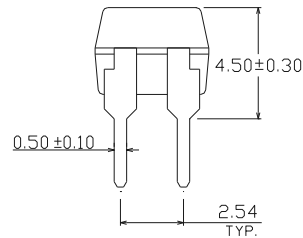
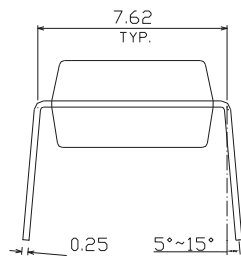
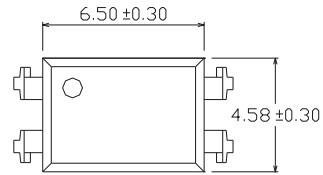

#### Option M Type

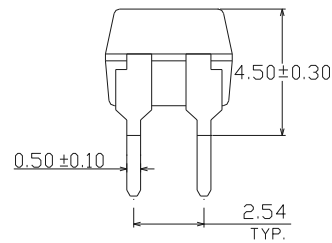
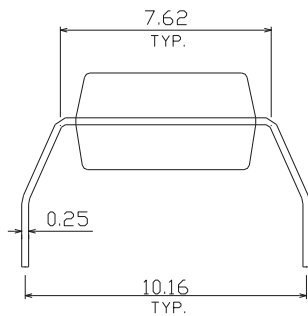
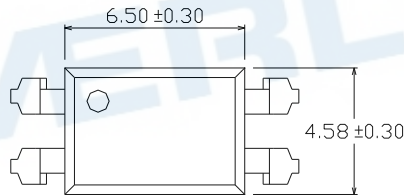



**Option S Type**

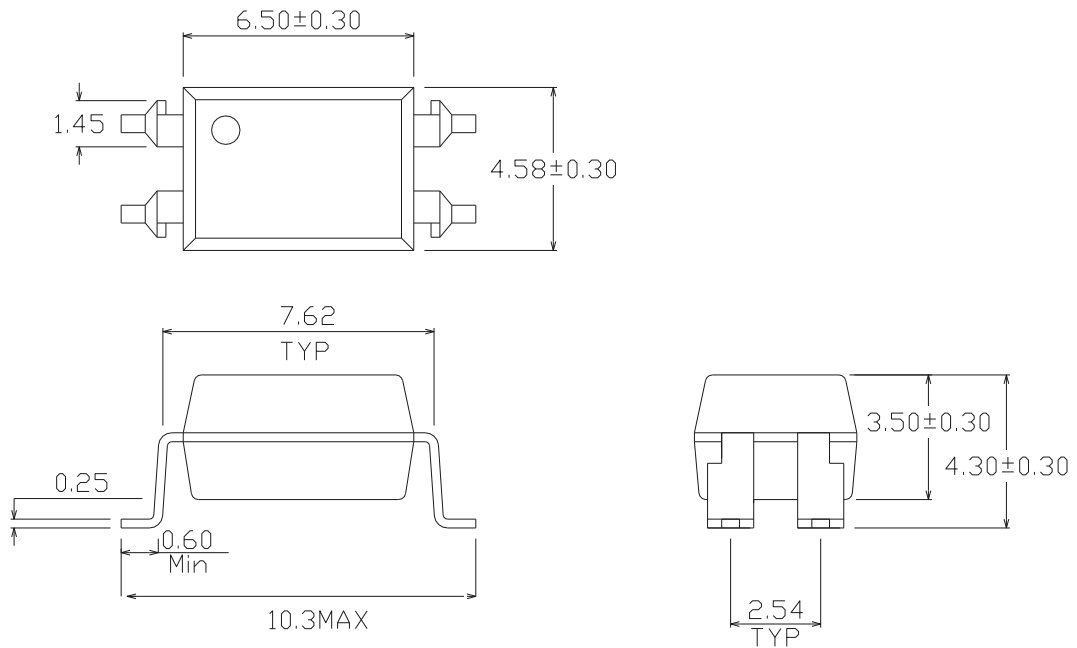

**Option S1 Type**

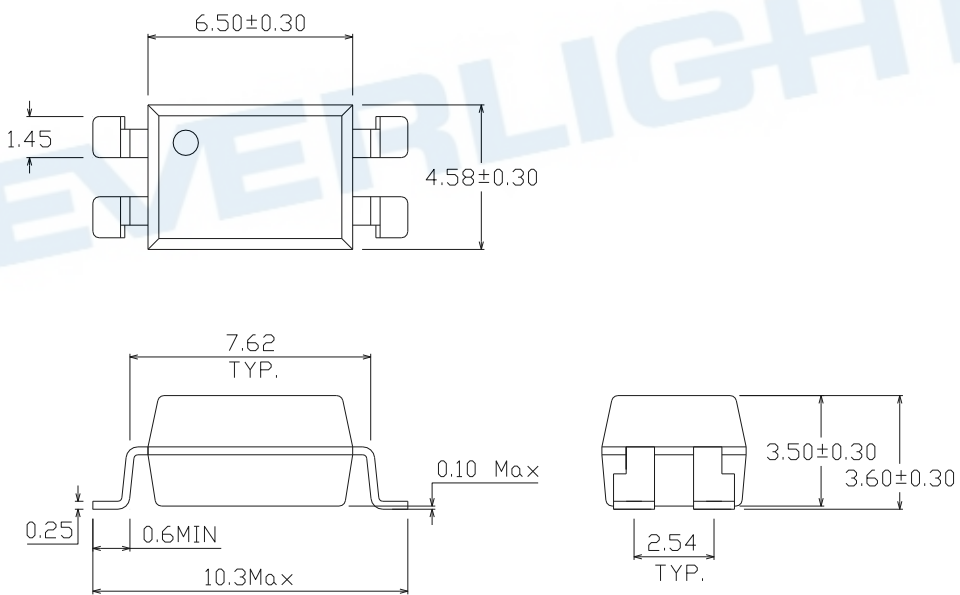

**Recommended pad layout for surface mount leadform**

**For S option**

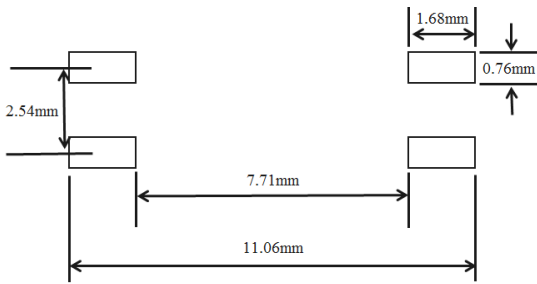

**For S1 option**

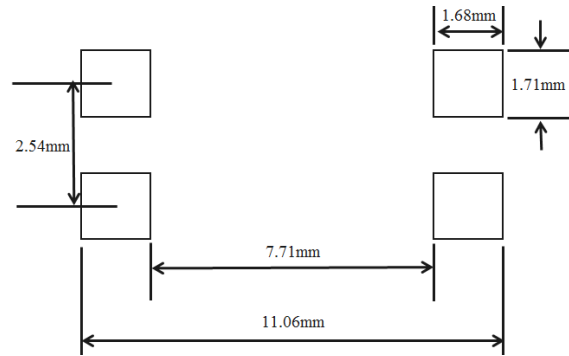

**Device Marking**

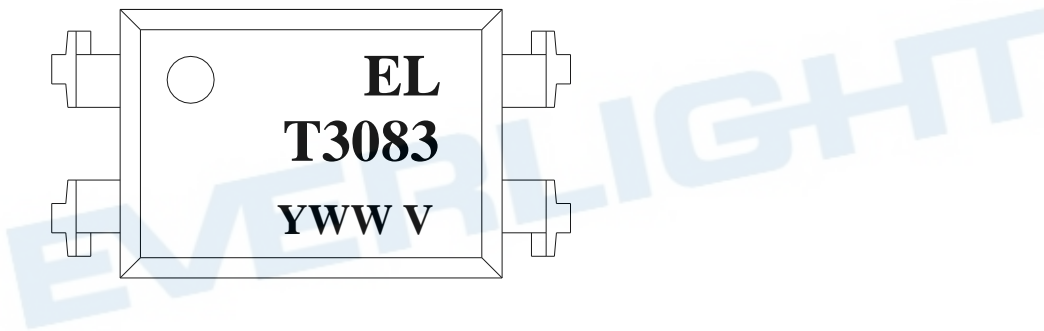

**Notes**

- EL denotes Everlight
- T3083 denotes Device Number
- Y denotes 1 digit Year code
- WW denotes 2 digit Week code
- V denotes VDE option

**Tape & Reel Packing Specifications**

**Option TA**

**Option TB**

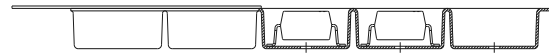
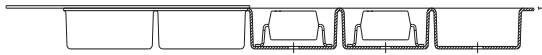
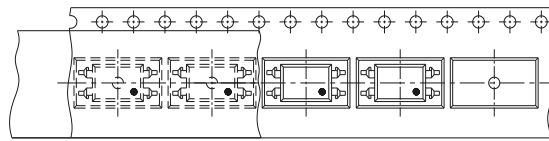
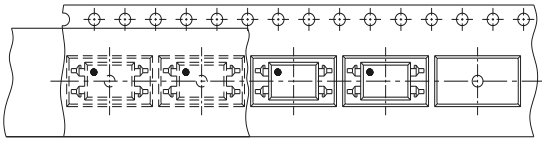

Direction of feed from reel

Direction of feed from reel

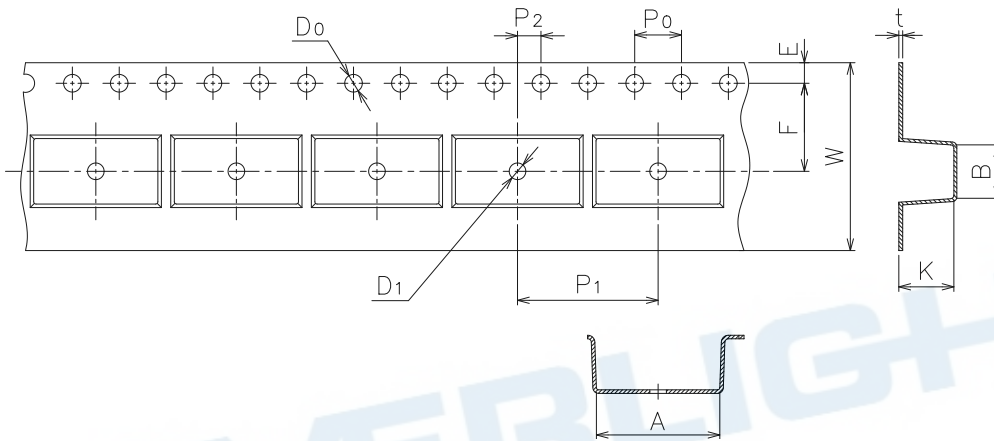
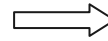
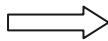

Dimension No.	<b>A</b>	<b>B</b>	<b>Do</b>	<b>D1</b>	<b>E</b>	<b>F</b>
Dimension (mm) S	10.7±0.1	4.65±0.1	1.5±0.1	1.50±0.1	1.75±0.1	7.5±0.1
Dimension (mm) S1	10.7±0.1	4.65±0.1	1.5±0.1	1.50±0.1	1.75±0.1	7.5±0.1
Dimension No.	<b>Po</b>	<b>P1</b>	<b>P2</b>	<b>t</b>	<b>W</b>	<b>K</b>
Dimension (mm) S	4.0±0.1	12.0±0.1	2.0±0.1	0.4±0.1	16.0±0.3	4.75±0.1
Dimension (mm) S1	4.0±0.1	12.0±0.1	2.0±0.1	0.4±0.1	16.0±0.3	3.90±0.1

**Tape dimensions**

**Option TD**

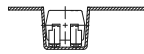
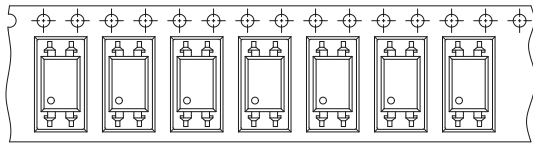

Direction of feed from reel

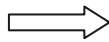

**Option TU**

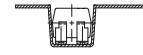
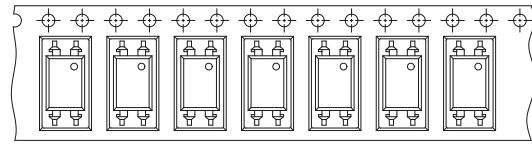

Direction of feed from reel

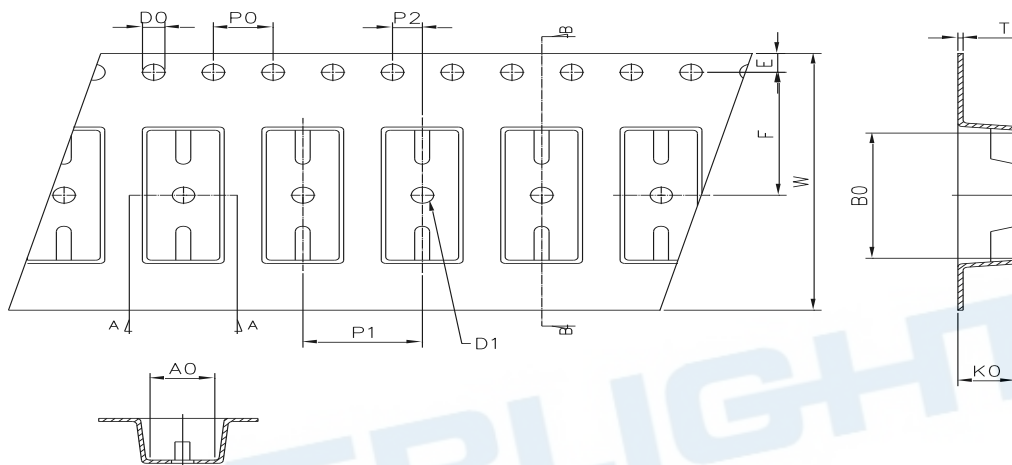
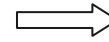

Dimension No.	<b>Ao</b>	<b>Bo</b>	<b>Do</b>	<b>D1</b>	<b>E</b>	<b>F</b>
Dimension (mm) S.S1	4.90±0.1	10.40±0.1	1.5±0.1	1.50±0.1	1.75±0.1	7.50±0.1
Dimension No.	<b>Po</b>	<b>P1</b>	<b>P2</b>	<b>t</b>	<b>W</b>	<b>Ko</b>
Dimension (mm) S.S1	4.00±0.1	8.00±0.	2.00±0.1	0.40±0.1	16.00±0.3	4.60±0.1

**Precautions for Use**

1. Soldering Condition

1.1 (A) Maximum Body Case Temperature Profile for evaluation of Reflow Profile

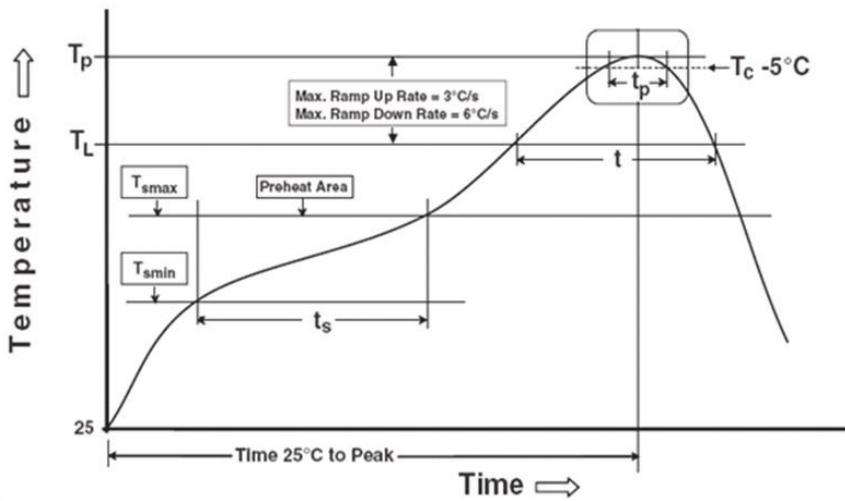

Note:

Reference: IPC/JEDEC J-STD-020D

**Preheat**

Temperature min ( $T_{smin}$ )	150 °C
Temperature max ( $T_{smax}$ )	200°C
Time ( $T_{smin}$ to $T_{smax}$ ) ( $t_s$ )	60-120 seconds
Average ramp-up rate ( $T_{smax}$ to $T_p$ )	3 °C/second max

**Other**

Liquidus Temperature ( $T_L$ )	217 °C
Time above Liquidus Temperature ( $t_L$ )	60-100 sec
Peak Temperature ( $T_p$ )	260°C
Time within 5 °C of Actual Peak Temperature: $T_p - 5^\circ\text{C}$	30 s
Ramp- Down Rate from Peak Temperature	6°C /second max.
Time 25°C to peak temperature	8 minutes max.
Reflow times	3 times

## DISCLAIMER

1. Above specification may be changed without notice. EVERLIGHT will reserve authority on material change for above specification.
2. The graphs shown in this datasheet are representing typical data only and do not show guaranteed values.
3. When using this product, please observe the absolute maximum ratings and the instructions for use outlined in these specification sheets. EVERLIGHT assumes no responsibility for any damage resulting from use of the product which does not comply with the absolute maximum ratings and the instructions included in these specification sheets.
4. These specification sheets include materials protected under copyright of EVERLIGHT. Reproduction in any form is prohibited without the specific consent of EVERLIGHT.
5. This product is not intended to be used for military, aircraft, automotive, medical, life sustaining or life saving applications or any other application which can result in human injury or death. Please contact authorized Everlight sales agent for special application request.
6. Statements regarding the suitability of products for certain types of applications are based on Everlight's knowledge of typical requirements that are often placed on Everlight products in generic applications. Such statements are not binding statements about the suitability of products for a particular application. It is the customer's responsibility to validate that a particular product with the properties described in the product specification is suitable for use in a particular application. Parameters provided in datasheets and/or specifications may vary in different applications and performance may vary over time. All operating parameters, including typical parameters, must be validated for each customer application by the customer's technical experts. Product specifications do not expand or otherwise modify Everlight's terms and conditions of purchase, including but not limited to the warranty expressed therein.