

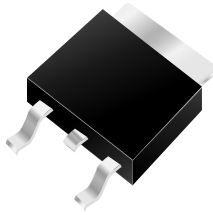

Excellent Schottky Barrier Rectifiers



D2PAK

Primary Characteristics		
I_F	20	A
V_{RRM}	300	V
I_{FSM}	120	A
V_F	0.98	V
$T_J \text{ max}$	150	°C

Features
<ul style="list-style-type: none"> • Low Forward Voltage Drop • Excellent High Temperature Stability • Excellent Barrier Rectifier Technology • Soft, Fast Switching Capability

Mechanical Data
<ul style="list-style-type: none"> • Case: D2-PAK • Case Material: Molded Plastic, UL Flammability Classification Rating 94V-0 • Terminals: Matte Tin Finish annealed over Copper leadframe. Solderable per MIL-STD-202, Method 208 • Weight: 1.43 grams (approximate)

Ordering Information			
Part No.	Remark	Package	Packing
EBRP20M300CD2	General	D2PAK	800 / Reel
EBRP20M300CD2-H	Halogen Free		

Maximum Ratings (TA=25°C unless otherwise noted)			
PARAMETER	SYMBOL	EBRP20M300CD2	UNIT
Maximum repetitive peak reverse voltage	V_{RRM}	300	V
Maximum RMS voltage	V_{RMS}	210	V
Maximum DC blocking voltage	V_{DC}	300	V
Maximum average forward rectified current (Total) (Per Leg)	I_F	20 10	A
Peak forward surge current, 8.3ms single half sine-wave superimposed on rated load	I_{FSM}	120	A
Maximum Instantaneous Forward Voltage $I_F=5A @ 25^\circ C$ $I_F=10A @ 25^\circ C$	V_F	0.80 Typ. 0.98 Max.	V
Maximum DC Reverse Current @ TA=25°C at Rated DC Blocking Voltage @ TA=125°C	I_R	0.2 5	mA
Typical Junction Capacitance(NOTE1)	C_j	90	pF
Typical Thermal Resistance	$R_{\theta JC}$	3	°C/W
Operating Temperature Range	T_J	-55 to +150	°C
Storage Temperature Range	T_{STG}	-55 to +175	°C
Marking Code		P20M300CD2 · 20M300CD2	

NOTES:

1. Measured at 1.0MHz and applied reverse voltage of 4.0V DC



Excellent Schottky Barrier Rectifiers

Rating and Characteristics Curves

FIG. 1-Typical Forward Current Derating Curve

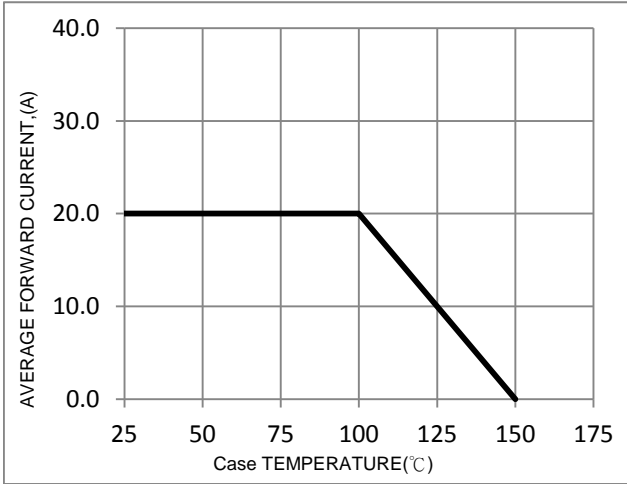

FIG. 2-Typical Forward Characteristics

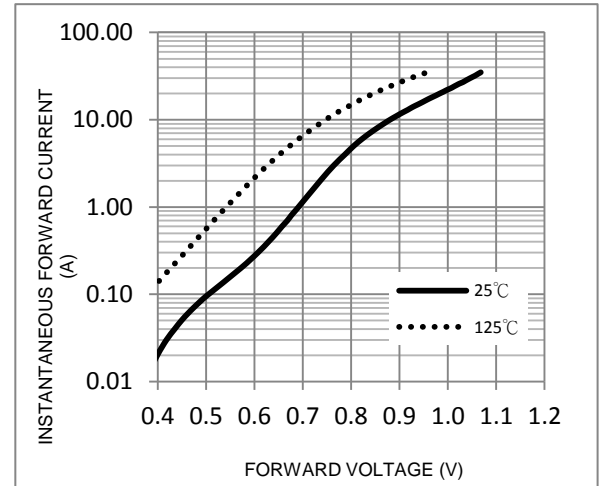

FIG. 3-Maximum Non-Repetitive Forward Surge Current

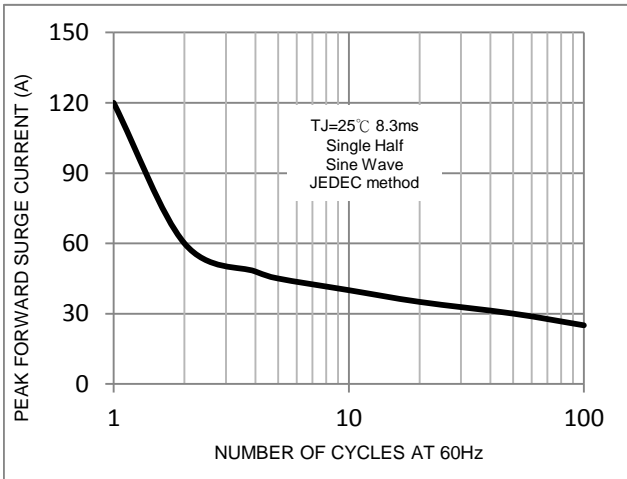

FIG. 4-Typical Reverse Characteristics

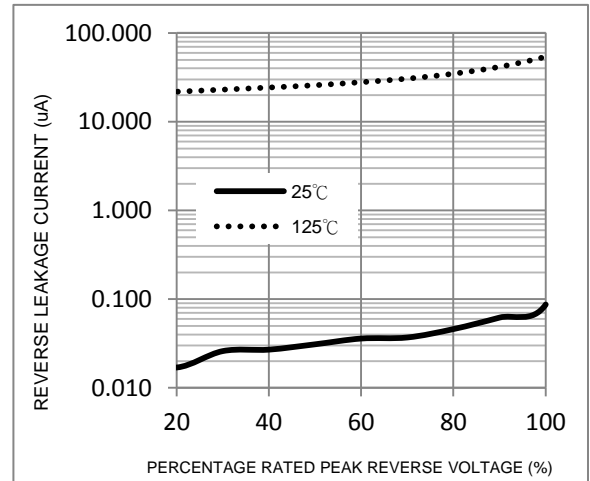
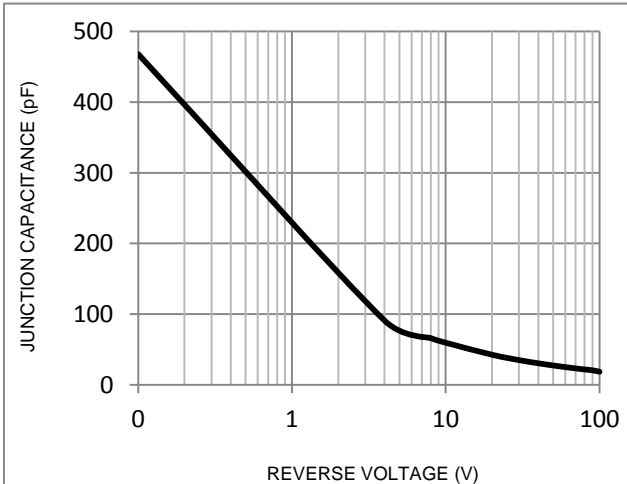
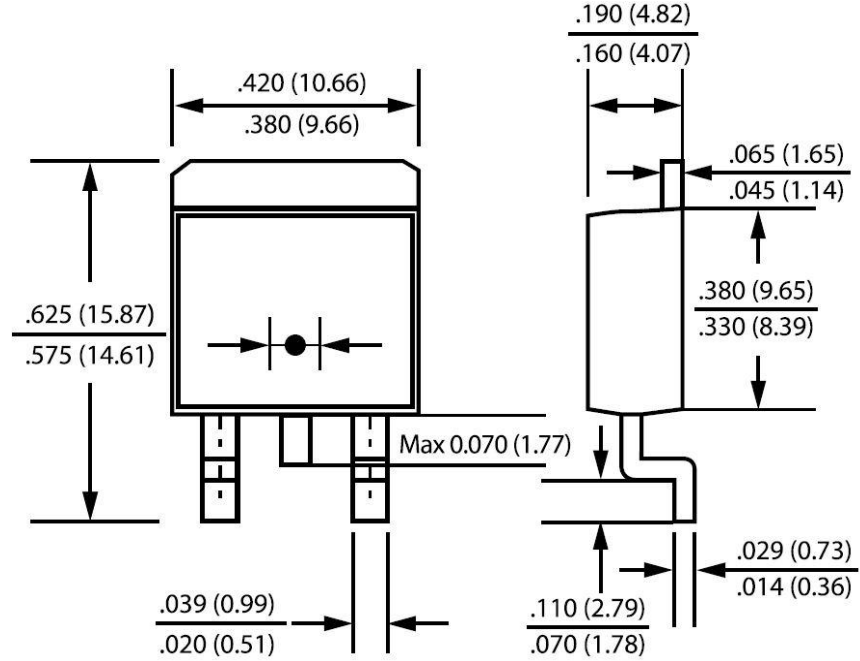

FIG. 5-Typical Junction Capacitance





Package Outline Dimensions



D2PAK

Dimensions in inches and (millimeters)

Marking Information

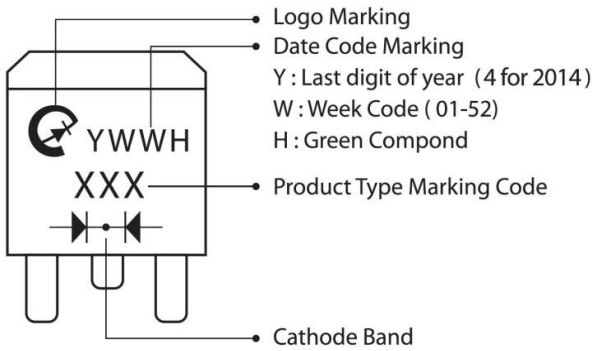

Suggested Pad Layout

Dimension	Outline	D2PAK (mm)
A		5.08
B		1.10
C		10.80
D		8.30
E		3.50
F		16.90

