



# EBRP10L60T



## Excellent Schottky Barrier Rectifiers



TO-277

Features
<ul style="list-style-type: none"> <li>• Schottky barrier diodes</li> <li>• Low forward voltage drop</li> <li>• Low leakage current</li> <li>• Moisture sensitivity: level 1, per J-STD-020</li> <li>• Solder dip 260 °C, 10 s</li> <li>• Low profile</li> <li>• Heatsink design</li> </ul>

Ordering Information		
Part No.	Package	Packing
EBRP10L60T	TO-277	5000 / Reel

Device P/N	
Part Number	Remark
EBRP10L60T	General
EBRP10L60T-H	Halogen Free

Primary Characteristics		
$I_F$	10	A
$V_{RRM}$	60	V
$I_{FSM}$	150	A
$V_F$	0.32 Typ. (IF=2A @ 25°C)	V
$T_J$ max	150	°C

Mechanical Data
<ul style="list-style-type: none"> <li>• Case: TO-277</li> <li>• Case Material: Molded Plastic. UL Flammability Classification Rating 94V-0</li> <li>• Terminals: Lead Free Plating (Tin Finish). Solderable per MIL-STD-202, Method 208</li> <li>• Polarity: Cathode Band</li> <li>• Weight: 0.096 grams (approximate)</li> </ul>

Maximum Ratings (TA=25°C unless otherwise noted)			
PARAMETER	SYMBOL	EBRP10L60T	UNIT
Maximum repetitive peak reverse voltage	$V_{RRM}$	60	V
Maximum RMS voltage	$V_{RMS}$	42	V
Maximum DC blocking voltage	$V_{DC}$	60	V
Maximum average forward rectified current	$I_F$	10	A
Peak forward surge current, 8.3ms single half sine-wave superimposed on rated load	$I_{FSM}$	150	A
Maximum Instantaneous Forward Voltage IF=2A @ 25°C IF=10A @ 25°C	$V_F$	0.32 Typ. 0.50 Max.	V
Maximum DC Reverse Current @ TA=25°C at Rated DC Blocking Voltage @ TA=125°C	$I_R$	0.5 50	mA
Typical Junction Capacitance(NOTE1)	$C_j$	710	pF
Typical Thermal Resistance	$R_{\theta JC}$	10	°C/W
Operating Temperature Range	$T_J$	-55 to +150	°C
Storage Temperature Range	$T_{STG}$	-55 to +150	°C
Marking Code		10L60T 、 P10L60T	

NOTES:

1.Measured at 1.0MHZ and applied reverse voltage of 4.0V DC



## Excellent Schottky Barrier Rectifiers

### Rating and Characteristics Curves

FIG. 1-Typical Forward Current Derating Curve

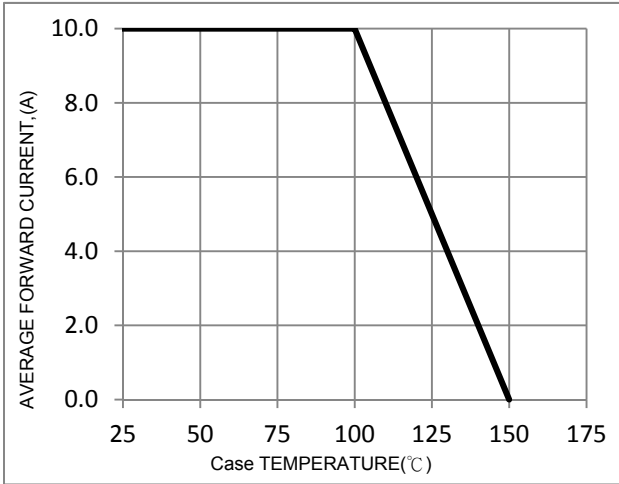

FIG. 2-Typical Forward Characteristics

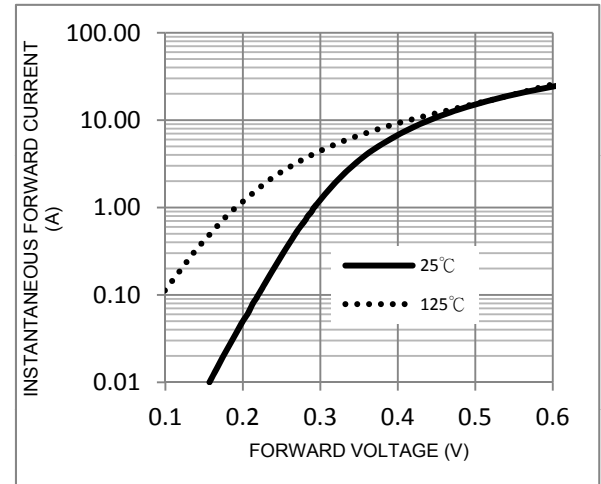

FIG. 3-Maximum Non-Repetitive Forward Surge Current

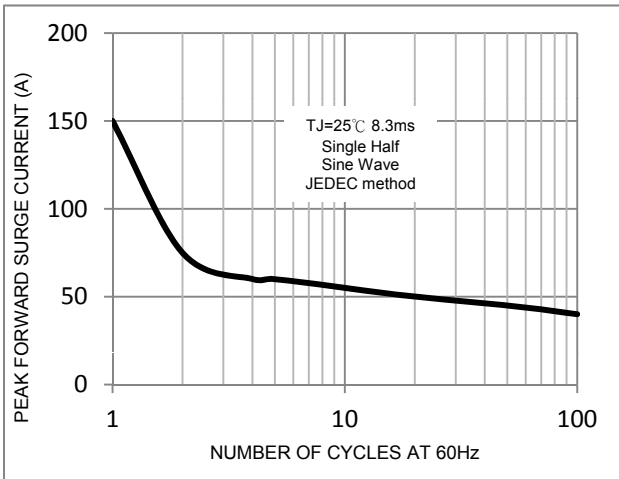

FIG. 4-Typical Reverse Characteristics

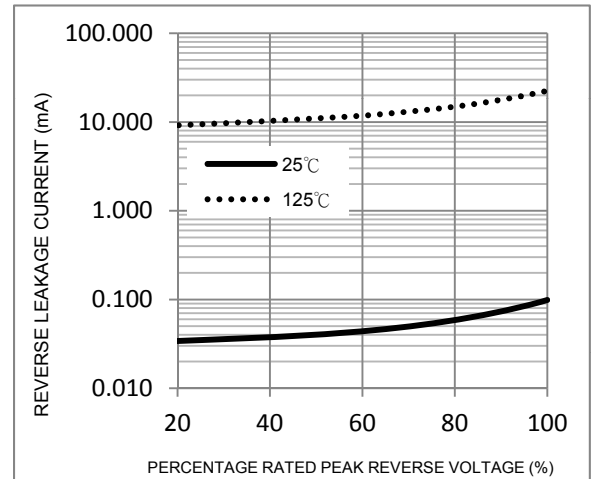
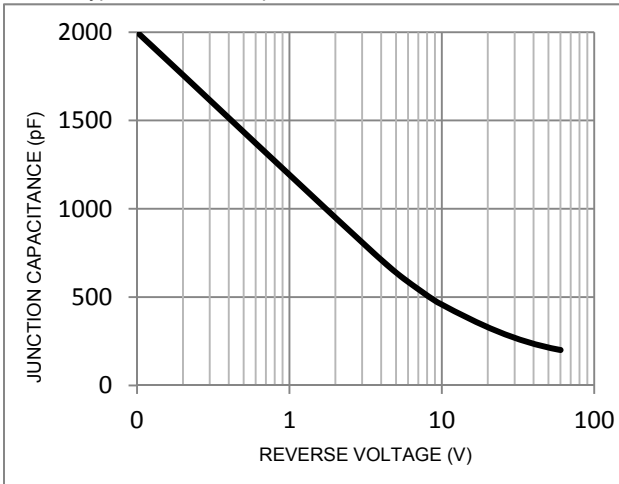

FIG. 5-Typical Junction Capacitance





# Excellent Schottky Barrier Rectifiers

## Package Outline Dimensions

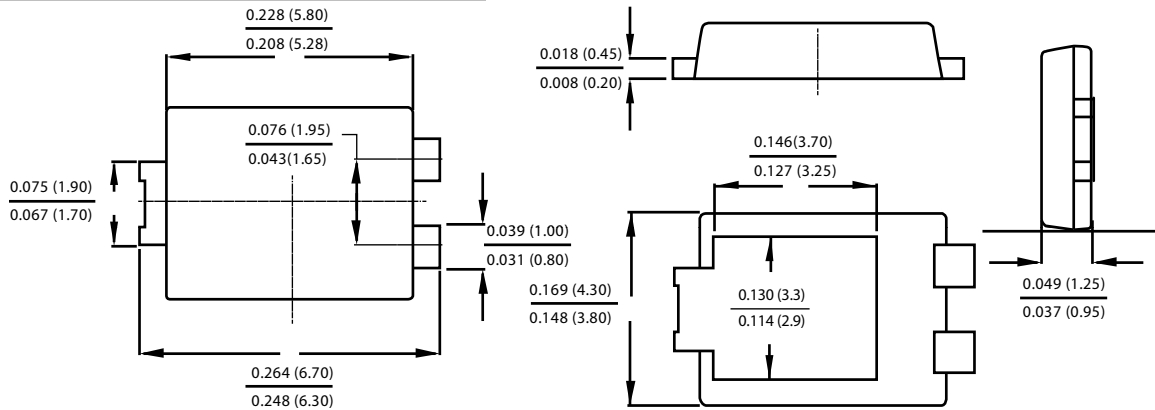

### TO-277

Dimensions in inches and (millimeters)

## Marking Information

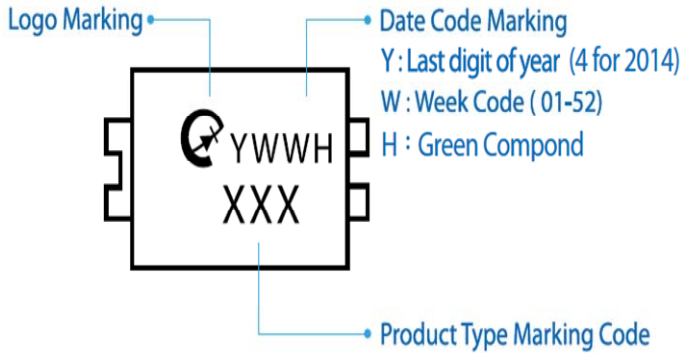

## Suggested Pad Layout

Dimension	Outline	TO-277
A		1.94
B		1.00
C		3.20
D		4.90
E		1.00
F		1.40

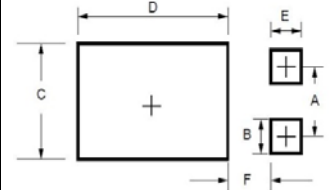

## Tape & Reel Specification

ITEM	SYMBOL	TO-277 (mm)
Carrier width	A	4.38(max)
Carrier length	B	6.9(MAX)
Carrier depth	C	1.4±0.1
Sprocket hole	d	1.50±0.1
Reel outside diameter	D	330±2.0
Feed hole diameter	D0	13.0±0.2
Reel inner diameter	D1	100 (min.)
Sprocket hole position	E	1.75±0.1
Punch hole position	F	7.5±0.05
Sprocket hole pitch	P	8.0±0.1
Sprocket hole pitch	Po	4.0±0.1
Embossment center	P1	2.0±0.10
Overall tape thickness	T	0.6 (max)
Tape width	W	16.0±0.3
Reel width	W2	20(max)
Reel width	W1	16(max)

