



SGM48541/SGM48542 SGM48543/SGM48544/SGM48545 Single High-Speed, Low-Side Gate Drivers with Negative Input Voltage Capability

GENERAL DESCRIPTION

The SGM48541/2/3/4/5 are single high-speed low-side gate drivers for Power MOSFET switches. These devices can provide rail-to-rail driving capability and very small propagation delays (17.5ns, TYP). They also provide 4A peak source current and 8A peak sink current (asymmetrical drive) when $V_{DD} = 12V$. The input can withstand a maximum negative voltage of -10V.

The operating voltage range is 4.5V to 25V. The devices feature under-voltage lockout (UVLO) function. After UVLO is triggered, the output remains low.

The SGM48541 adopts separate output architecture. The separate output structure with asymmetric drive improves the immunity of the device to the parasitic Miller conduction effect and reduces ground bounce.

The SGM48541/4 adopt a dual-input design. IN+ or IN- can independently control the output of the driver. The unused pin can be functioned as an enable control pin. In order to ensure that the output remains low when an input pin is floating, these input pins have internal pull-up and pull-down resistors.

The input thresholds of these devices are compatible with low voltage TTL and CMOS logic, which will not be affected by V_{DD} changes. A Schmitt trigger is used at the input, and a wide range of hysteresis voltage is designed to enhance the immunity.

The SGM48541 is available in Green SOT-23-6 and TDFN-3×3-6AL packages. The SGM48542/3/4/5 are all available in a Green SOT-23-5 package.

FEATURES

- **Asymmetrical Drive**
 - ◆ 4A Peak Source Current
 - ◆ 8A Peak Sink Current
- **TTL and CMOS Compatible Logic Threshold**
- **Logic Levels Independent of Supply Voltage**
- **Hysteretic Input Logic for High Noise Immunity**
- **Outputs are Logic Low when Inputs are Floating**
- **Negative Voltage Handling Capability:**
 - ◆ -10V DC at Inputs
 - ◆ -2V, 200ns Pulse for Outputs
- **Glitch-Free Operation at Power-Up and Power-Down: Outputs are Pulled Low during Supply UVLO**
- **Fast Propagation Delays: 17.5ns (TYP)**
- **Fast Rise Time: 7ns (TYP)**
- **Fast Fall Time: 6.5ns (TYP)**
- **SGM48541 Separate Output Options Allow for Tuning of Turn-on and Turn-off Currents**
- **SGM48541/4 Dual Input Design (Choice of an Inverting (IN-) or Non-Inverting (IN+) Driver Configuration)**
 - ◆ Unused Input Pin can be Used for Enable or Disable Function
- **Input Pin Absolute Maximum Voltage Levels Not Restricted by VDD Pin Bias Supply Voltage**
- **-40°C to +140°C Operating Temperature Range**
- **Small Packaging:**
 - SGM48541 Available in Green SOT-23-6 and TDFN-3×3-6AL Packages
 - SGM48542/3/4/5 Available in a Green SOT-23-5 Package

APPLICATIONS

Power MOSFETs Driving for Power Supplies
DC/DC Converters
Solar Power, Motor Drivers

PACKAGE/ORDERING INFORMATION

MODEL	PACKAGE DESCRIPTION	SPECIFIED TEMPERATURE RANGE	ORDERING NUMBER	PACKAGE MARKING	PACKING OPTION
SGM48541	SOT-23-6	-40°C to +140°C	SGM48541XN6G/TR	07LXX	Tape and Reel, 3000
	TDFN-3×3-6AL	-40°C to +140°C	SGM48541XTGV6G/TR	SGM07T XTGV6 XXXXX	Tape and Reel, 4000
SGM48542	SOT-23-5	-40°C to +140°C	SGM48542XN5G/TR	07MXX	Tape and Reel, 3000
SGM48543	SOT-23-5	-40°C to +140°C	SGM48543XN5G/TR	07NXX	Tape and Reel, 3000
SGM48544	SOT-23-5	-40°C to +140°C	SGM48544XN5G/TR	07PXX	Tape and Reel, 3000
SGM48545	SOT-23-5	-40°C to +140°C	SGM48545XN5G/TR	07QXX	Tape and Reel, 3000

MARKING INFORMATION

NOTE: XX = Date Code. XXXXX = Date Code, Trace Code and Vendor Code.

SOT-23-6/SOT-23-5

YYY X X

└── Date Code - Week
└── Date Code - Year
└── Serial Number

TDFN-3×3-6AL

XXXXX

└── Vendor Code
└── Trace Code
└── Date Code - Year

Green (RoHS & HSF): SG Micro Corp defines "Green" to mean Pb-Free (RoHS compatible) and free of halogen substances. If you have additional comments or questions, please contact your SGMICRO representative directly.

ABSOLUTE MAXIMUM RATINGS

Supply Voltage Range, V_{DD} -0.3V to 28V
EN, IN+, IN- Voltage Range..... -10V to 28V
OUTH, OUTL, OUT Voltage Range
DC.....-0.3V to $V_{DD} + 0.3V$
Repetitive Pulse < 200ns-2V to $V_{DD} + 0.3V$
Package Thermal Resistance
SOT-23-6, θ_{JA} 165°C/W
TDFN-3×3-6AL, θ_{JA} 57°C/W
SOT-23-5, θ_{JA} 172°C/W
Junction Temperature.....+150°C
Storage Temperature Range-65°C to +150°C
Lead Temperature (Soldering, 10s).....+260°C
ESD Susceptibility
HBM
SGM48541 (TDFN-3×3-6AL), SGM48542/3/4/5 4000V
SGM48541 (SOT-23-6)..... 3000V
CDM 1000V

RECOMMENDED OPERATING CONDITIONS

Supply Voltage Range, V_{DD} 4.5V to 25V
EN, IN+, IN- Voltage Range..... -10V to 25V
Operating Junction Temperature Range..... -40°C to +140°C

OVERSTRESS CAUTION

Stresses beyond those listed in Absolute Maximum Ratings may cause permanent damage to the device. Exposure to absolute maximum rating conditions for extended periods may affect reliability. Functional operation of the device at any conditions beyond those indicated in the Recommended Operating Conditions section is not implied.

ESD SENSITIVITY CAUTION

This integrated circuit can be damaged if ESD protections are not considered carefully. SGMICRO recommends that all integrated circuits be handled with appropriate precautions. Failure to observe proper handling and installation procedures can cause damage. ESD damage can range from subtle performance degradation to complete device failure. Precision integrated circuits may be more susceptible to damage because even small parametric changes could cause the device not to meet the published specifications.

DISCLAIMER

SG Micro Corp reserves the right to make any change in circuit design, or specifications without prior notice.

PIN CONFIGURATIONS

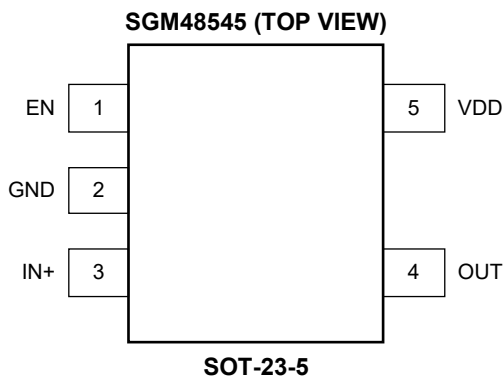
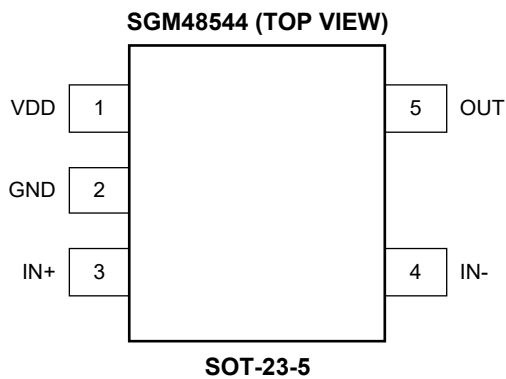
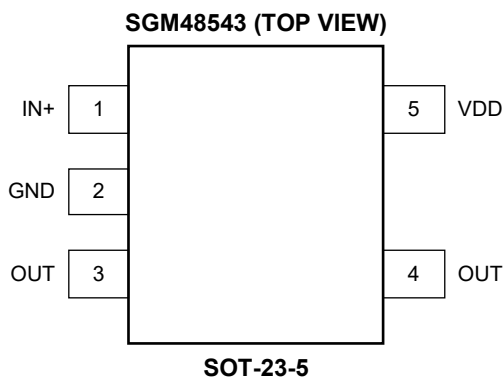
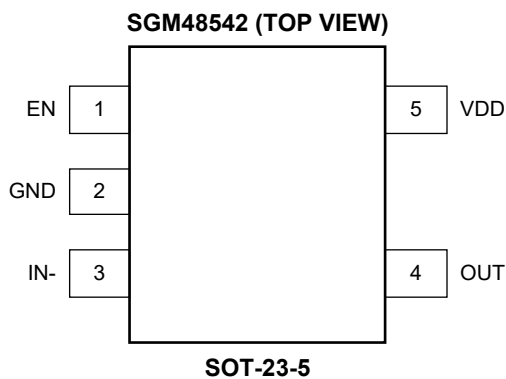
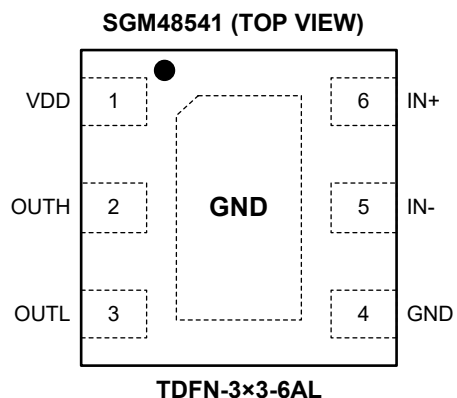
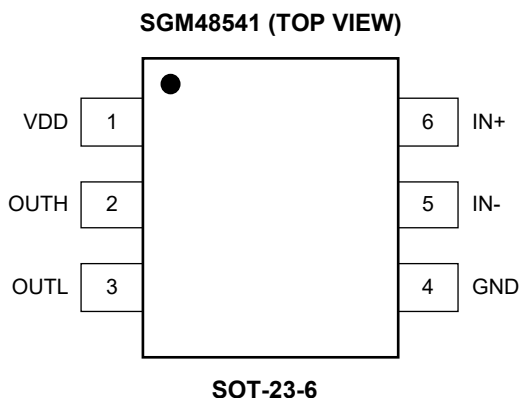

PIN DESCRIPTION

PIN					NAME	I/O	FUNCTION
SGM48541	SGM48542	SGM48543	SGM48544	SGM48545			
1	5	5	1	5	VDD	I	Power Supply Input.
2	—	—	—	—	OUTH	O	Driver Source Current Output.
3	—	—	—	—	OUTL	O	Driver Sink Current Output.
4	2	2	2	2	GND	—	Ground. Reference pin for all signals.
5	3	—	4	—	IN-	I	Inverting Input. OUT is logic low if IN- is unbiased or left floating. For the SGM48541/4, when IN+ is used as a non-inverting input, pull IN- down to GND to enable output. Inject PWM signal to this pin when the driver is used in inverting configuration.
6	—	1	3	3	IN+	I	Non-Inverting Input. OUT is logic low if IN+ is unbiased or left floating. For the SGM48541/4, when IN- is used as an inverting input, pull IN+ up to VDD to enable output. Inject PWM signal to this pin when the driver is used in non-inverting configuration.
Exposed Pad	—	—	—	—	GND	—	Exposed Pad. It should be soldered to PCB board and connected to GND.
—	1	—	—	1	EN	I	Enable Input. Pull EN high or leave it floating to enable output. Pull EN low to disable output, ignoring input state.
—	4	3, 4	5	4	OUT	O	Driver Source/Sink Current Output.

NOTE: I: input, O: output.

PACKAGE INFORMATION

PACKAGE OUTLINE DIMENSIONS

SOT-23-5

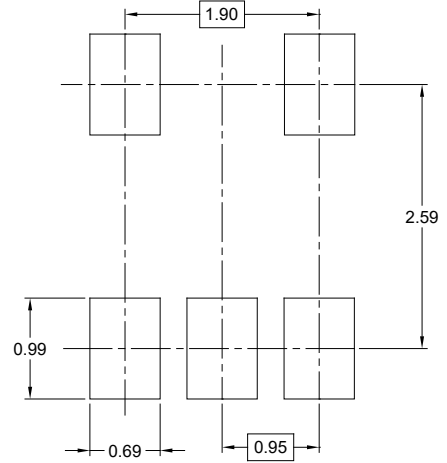
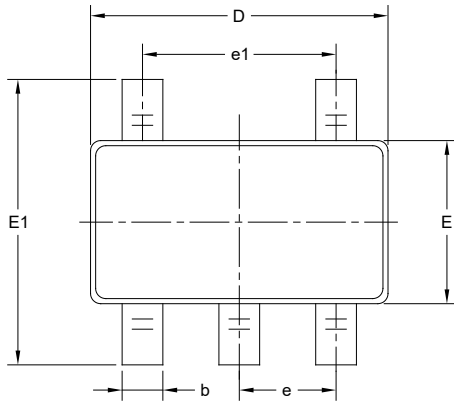

RECOMMENDED LAND PATTERN (Unit: mm)

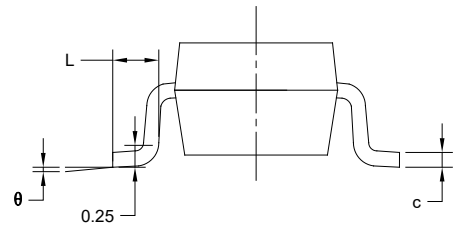
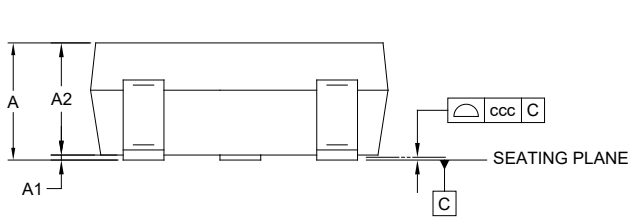

Symbol	Dimensions In Millimeters		
	MIN	MOD	MAX
A	-	-	1.450
A1	0.000	-	0.150
A2	0.900	-	1.300
b	0.300	-	0.500
c	0.080	-	0.220
D	2.750	-	3.050
E	1.450	-	1.750
E1	2.600	-	3.000
e	0.950 BSC		
e1	1.900 BSC		
L	0.300	-	0.600
θ	0°	-	8°
ccc	0.100		

NOTES:

1. This drawing is subject to change without notice.
2. The dimensions do not include mold flashes, protrusions or gate burrs.
3. Reference JEDEC MO-178.

PACKAGE OUTLINE DIMENSIONS

SOT-23-6

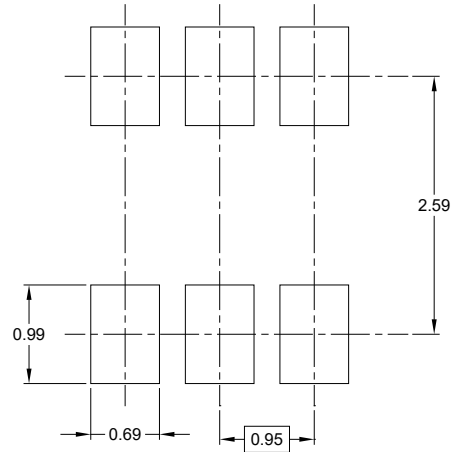
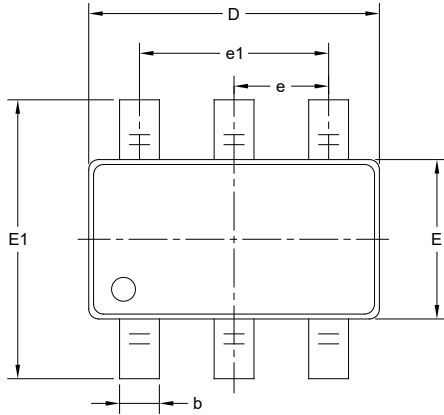

RECOMMENDED LAND PATTERN (Unit: mm)

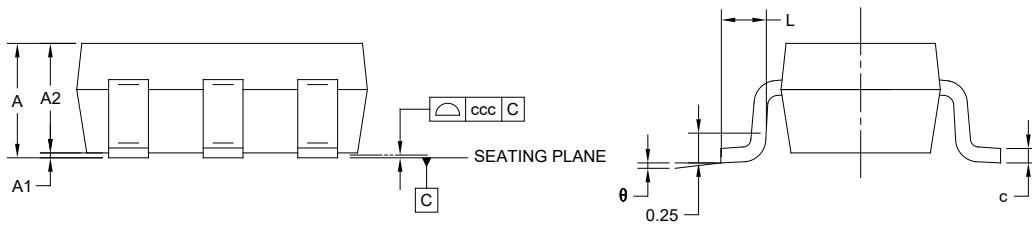

Symbol	Dimensions In Millimeters		
	MIN	MOD	MAX
A	-	-	1.450
A1	0.000	-	0.150
A2	0.900	-	1.300
b	0.300	-	0.500
c	0.080	-	0.220
D	2.750	-	3.050
E	1.450	-	1.750
E1	2.600	-	3.000
e	0.950 BSC		
e1	1.900 BSC		
L	0.300	-	0.600
θ	0°	-	8°
ccc	0.100		

NOTES:

1. This drawing is subject to change without notice.
2. The dimensions do not include mold flashes, protrusions or gate burrs.
3. Reference JEDEC MO-178.

PACKAGE OUTLINE DIMENSIONS

TDFN-3x3-6AL

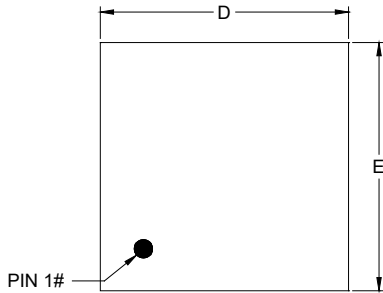

TOP VIEW

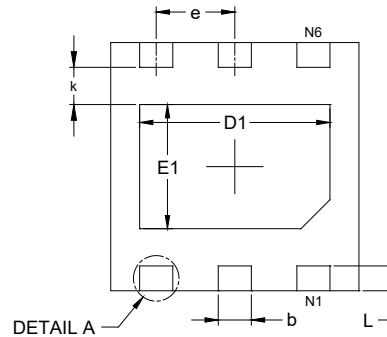

BOTTOM VIEW

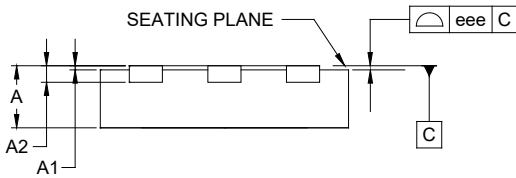

SIDE VIEW

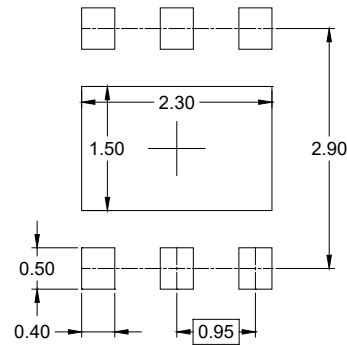
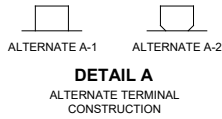

RECOMMENDED LAND PATTERN (Unit: mm)

Symbol	Dimensions In Millimeters		
	MIN	MOD	MAX
A	0.700	-	0.800
A1	0.000	-	0.050
A2	0.203 REF		
b	0.350	-	0.450
D	2.900	-	3.100
E	2.900	-	3.100
D1	2.200	-	2.400
E1	1.400	-	1.600
e	0.950 BSC		
k	0.450 REF		
L	0.200	-	0.400
eee	0.080		

NOTE: This drawing is subject to change without notice.

PACKAGE INFORMATION

TAPE AND REEL INFORMATION

REEL DIMENSIONS

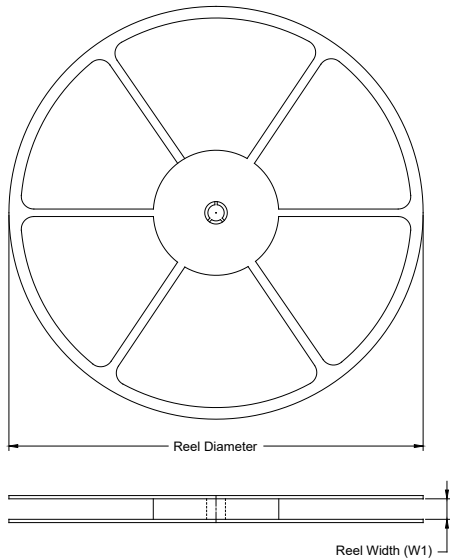

TAPE DIMENSIONS

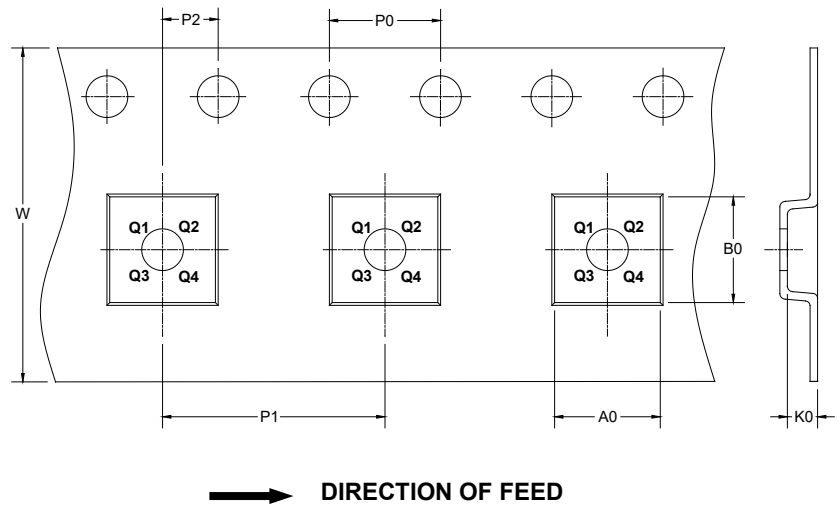

NOTE: The picture is only for reference. Please make the object as the standard.

KEY PARAMETER LIST OF TAPE AND REEL

Package Type	Reel Diameter	Reel Width W1 (mm)	A0 (mm)	B0 (mm)	K0 (mm)	P0 (mm)	P1 (mm)	P2 (mm)	W (mm)	Pin1 Quadrant
SOT-23-5	7"	9.5	3.20	3.20	1.40	4.0	4.0	2.0	8.0	Q3
SOT-23-6	7"	9.5	3.23	3.17	1.37	4.0	4.0	2.0	8.0	Q3
TDFN-3x3-6AL	13"	12.4	3.35	3.35	1.13	4.0	8.0	2.0	12.0	Q2

D00001

PACKAGE INFORMATION

CARTON BOX DIMENSIONS

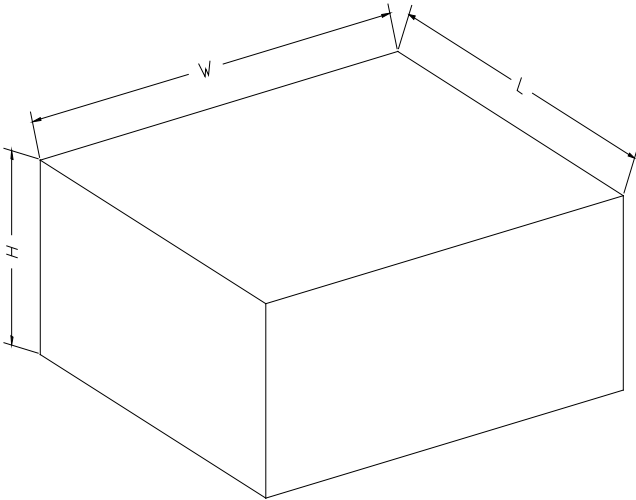

NOTE: The picture is only for reference. Please make the object as the standard.

KEY PARAMETER LIST OF CARTON BOX

Reel Type	Length (mm)	Width (mm)	Height (mm)	Pizza/Carton
7" (Option)	368	227	224	8
7"	442	410	224	18
13"	386	280	370	5

DD0002