

GENERAL DESCRIPTION

The SGM2217 is a low noise, high current and low dropout voltage linear regulator. It is capable of supplying 1.5A output current with typical dropout voltage of 1.3V. The operating input voltage range is from 2.8V to 30V. The fixed output voltages are 1.8V, 2.5V, 2.8V, 3.0V, 3.3V, 5.0V and 12V. The adjustable output voltage range is from 1.25V to 26V.

Other features include short-circuit current limit and thermal shutdown protection.

The SGM2217 is available in Green TO-263-3A and TDFN-4x4-8L packages. It operates over an operating temperature range of -40°C to +125°C.

FEATURES

- **Wide Input Voltage Range: 2.8V to 30V**
- **Adjustable Output from 1.25V to 26V**
- **Fixed Outputs of 1.8V, 2.5V, 2.8V, 3.0V, 3.3V, 5.0V and 12V**
- **1.5A Output Current**
- **Low Dropout Voltage: 1.3V (TYP) at 1.5A**
- **Line Regulation: 0.04% (TYP)**
- **Load Regulation: 0.04% (TYP)**
- **Current Limiting and Thermal Protection**
- **Excellent Load and Line Transient Responses**
- **Stable with Small Case Size Ceramic Capacitors**
- **-40°C to +125°C Operating Temperature Range**
- **Available in Green TO-263-3A and TDFN-4x4-8L Packages**

APPLICATIONS

- Battery Chargers
- Microprocessor Supplies
- Switching Power Supplies
- Constant Current Monitoring System

TYPICAL APPLICATION

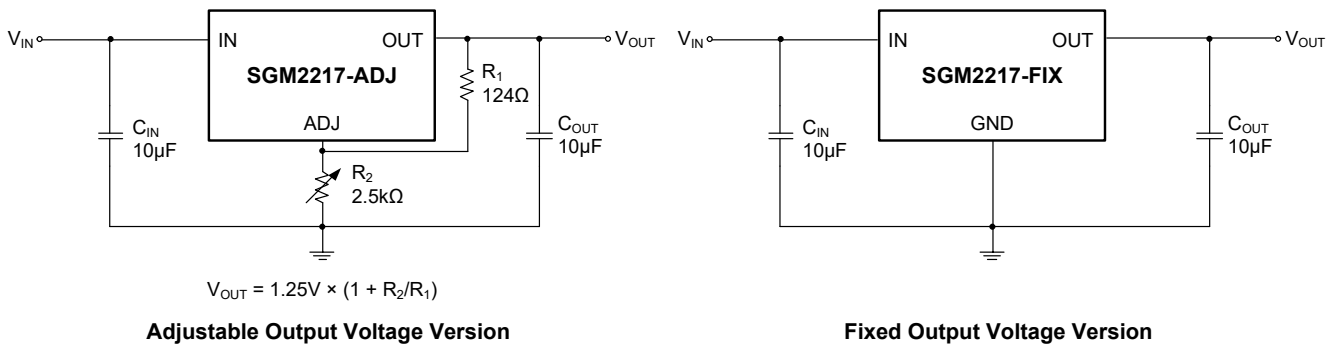

Figure 1. Typical Application Circuits

PACKAGE/ORDERING INFORMATION

MODEL	PACKAGE DESCRIPTION	SPECIFIED TEMPERATURE RANGE	ORDERING NUMBER	PACKAGE MARKING	PACKING OPTION
SGM2217-1.8	TO-263-3A	-40°C to +125°C	SGM2217-1.8XOA3G/TR	SGMR9B XOA3 XXXXX	Tape and Reel, 800
	TDFN-4x4-8L	-40°C to +125°C	SGM2217-1.8XTEL8G/TR	SGMR9D XTEL8 XXXXX	Tape and Reel, 3000
SGM2217-2.5	TO-263-3A	-40°C to +125°C	SGM2217-2.5XOA3G/TR	SGMRBA XOA3 XXXXX	Tape and Reel, 800
	TDFN-4x4-8L	-40°C to +125°C	SGM2217-2.5XTEL8G/TR	SGMRBB XTEL8 XXXXX	Tape and Reel, 3000
SGM2217-2.8	TO-263-3A	-40°C to +125°C	SGM2217-2.8XOA3G/TR	SGMRBC XOA3 XXXXX	Tape and Reel, 800
	TDFN-4x4-8L	-40°C to +125°C	SGM2217-2.8XTEL8G/TR	SGMRBD XTEL8 XXXXX	Tape and Reel, 3000
SGM2217-3.0	TO-263-3A	-40°C to +125°C	SGM2217-3.0XOA3G/TR	SGMRBE XOA3 XXXXX	Tape and Reel, 800
	TDFN-4x4-8L	-40°C to +125°C	SGM2217-3.0XTEL8G/TR	SGMRBF XTEL8 XXXXX	Tape and Reel, 3000
SGM2217-3.3	TO-263-3A	-40°C to +125°C	SGM2217-3.3XOA3G/TR	SGMRC0 XOA3 XXXXX	Tape and Reel, 800
	TDFN-4x4-8L	-40°C to +125°C	SGM2217-3.3XTEL8G/TR	SGMRC1 XTEL8 XXXXX	Tape and Reel, 3000
SGM2217-5.0	TO-263-3A	-40°C to +125°C	SGM2217-5.0XOA3G/TR	SGMRC2 XOA3 XXXXX	Tape and Reel, 800
	TDFN-4x4-8L	-40°C to +125°C	SGM2217-5.0XTEL8G/TR	SGMRC3 XTEL8 XXXXX	Tape and Reel, 3000
SGM2217-12	TO-263-3A	-40°C to +125°C	SGM2217-12XOA3G/TR	SGMR9C XOA3 XXXXX	Tape and Reel, 800
	TDFN-4x4-8L	-40°C to +125°C	SGM2217-12XTEL8G/TR	SGMRA3 XTEL8 XXXXX	Tape and Reel, 3000
SGM2217-ADJ	TO-263-3A	-40°C to +125°C	SGM2217-ADJXOA3G/TR	SGM2217 XOA3 XXXXX	Tape and Reel, 800
	TDFN-4x4-8L	-40°C to +125°C	SGM2217-ADJXTEL8G/TR	SGM2217 XTEL8 XXXXX	Tape and Reel, 3000

MARKING INFORMATION

NOTE: XXXXX = Date Code, Trace Code and Vendor Code.

TO-263-3A/TDFN-4x4-8L

XXXXX

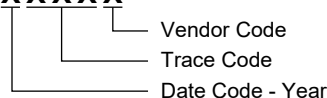

Green (RoHS & HSF): SG Micro Corp defines "Green" to mean Pb-Free (RoHS compatible) and free of halogen substances. If you have additional comments or questions, please contact your SGMICRO representative directly.

ABSOLUTE MAXIMUM RATINGS

Input to Output Voltage	31V
Package Thermal Resistance	
TO-263-3A, θ_{JA}	30°C/W
TO-263-3A, θ_{JB}	32°C/W
TO-263-3A, $\theta_{JC(TOP)}$	5°C/W
TO-263-3A, $\theta_{JC(BOT)}$	2°C/W
TDFN-4x4-8L, θ_{JA}	42°C/W
TDFN-4x4-8L, θ_{JB}	16°C/W
TDFN-4x4-8L, $\theta_{JC(TOP)}$	27°C/W
TDFN-4x4-8L, $\theta_{JC(BOT)}$	2°C/W
Junction Temperature	+150°C
Storage Temperature Range	-65°C to +150°C
Lead Temperature (Soldering, 10s)	+260°C
ESD Susceptibility	
HBM	3000V
CDM	1000V

RECOMMENDED OPERATING CONDITIONS

Input Voltage Range	2.8V to 30V
Input Effective Capacitance, C_{IN}	2.3 μ F (MIN)
Output Effective Capacitance, C_{OUT}	2.3 μ F to 100 μ F
Capacitor Effective Series Resistance, ESR	1m Ω to 8 Ω
Operating Junction Temperature Range	-40°C to +125°C

OVERSTRESS CAUTION

Stresses beyond those listed in Absolute Maximum Ratings may cause permanent damage to the device. Exposure to absolute maximum rating conditions for extended periods may affect reliability. Functional operation of the device at any conditions beyond those indicated in the Recommended Operating Conditions section is not implied.

ESD SENSITIVITY CAUTION

This integrated circuit can be damaged if ESD protections are not considered carefully. SGMICRO recommends that all integrated circuits be handled with appropriate precautions. Failure to observe proper handling and installation procedures can cause damage. ESD damage can range from subtle performance degradation to complete device failure. Precision integrated circuits may be more susceptible to damage because even small parametric changes could cause the device not to meet the published specifications.

DISCLAIMER

SG Micro Corp reserves the right to make any change in circuit design, or specifications without prior notice.

PIN CONFIGURATIONS

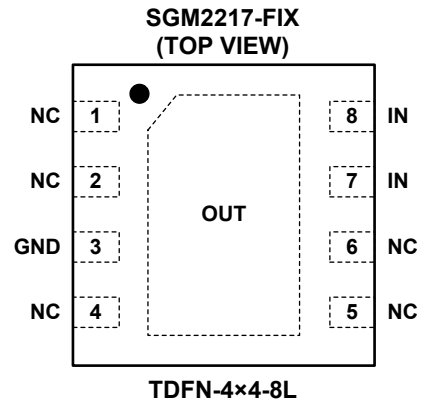
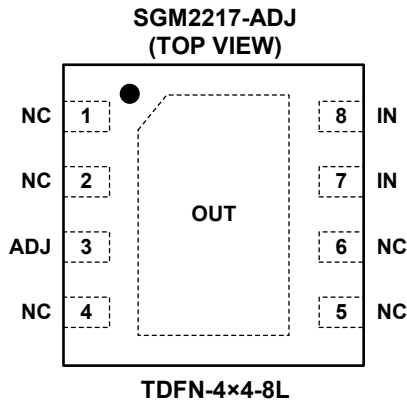
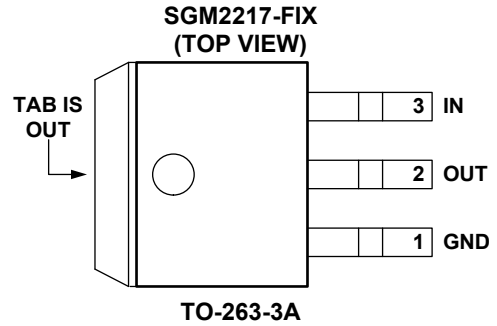
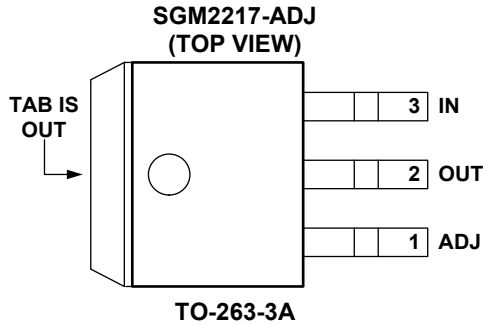

PIN DESCRIPTION

PIN		NAME	FUNCTION
TO-263-3A	TDFN-4x4-8L		
1	3	ADJ	Feedback Voltage Input Pin (adjustable output voltage version only). Connect this pin to the midpoint of an external resistor divider to adjust the output voltage. Place the resistors as close as possible to this pin.
		GND	Ground (fixed output voltage version only).
2, TAB	Exposed Pad	OUT	Regulator Output Pin. It is recommended to use a ceramic capacitor with effective capacitance in the range of 2.3µF to 100µF. This ceramic capacitor should be placed as close as possible to OUT pin.
3	7, 8	IN	Input Supply Voltage Pin. It is recommended to use a 4.7µF or larger ceramic capacitor from IN pin to ground. This ceramic capacitor should be placed as close as possible to IN pin.
—	1, 2, 4, 5, 6	NC	No Connection.

ELECTRICAL CHARACTERISTICS

(T_J = -40°C to +125°C, typical values are at T_J = +25°C, C_{IN} = C_{OUT} = 10μF (ceramic capacitor), unless otherwise noted.)

PARAMETER	SYMBOL	CONDITIONS	MIN	TYP	MAX	UNITS
Reference Voltage (SGM2217-ADJ)	V _{ADJ}	I _{OUT} = 5mA, (V _{IN} - V _{OUT}) = 3V, T _J = +25°C	1.238	1.25	1.262	V
		I _{OUT} = 5mA to 1.5A ⁽¹⁾ , V _{IN} = (1.55V + V _{OUT}) to 30V	1.225		1.275	
Output Voltage Accuracy (SGM2217-FIX)	V _{OUT}	I _{OUT} = 0mA, (V _{IN} - V _{OUT}) = 3V, T _J = +25°C	-1		+1	%
		I _{OUT} = 0mA to 1.5A ⁽¹⁾ , V _{IN} = (1.55V + V _{OUT}) to 30V	-2		+2	
ADJ Pin Current	I _{ADJ}	I _{OUT} = 5mA, (V _{IN} - V _{OUT}) = 3V, SGM2217-ADJ		8	20	μA
ADJ Pin Current Change	ΔI _{ADJ}	I _{OUT} = 5mA to 1.5A, (V _{IN} - V _{OUT}) = 1.55V to 15V, SGM2217-ADJ		0.2	2	μA
Line Regulation	$\frac{\Delta V_{OUT}}{V_{OUT}}$	I _{OUT} = 5mA, V _{IN} = (1.55V + V _{OUT}) to 30V, SGM2217-ADJ, T _J = +25°C		0.04	0.16	%
		I _{OUT} = 5mA, V _{IN} = (1.55V + V _{OUT}) to 30V, SGM2217-ADJ			0.20	
		I _{OUT} = 0mA, V _{IN} = (1.55V + V _{OUT}) to 30V, SGM2217-FIX, T _J = +25°C		0.04	0.16	
		I _{OUT} = 0mA, V _{IN} = (1.55V + V _{OUT}) to 30V, SGM2217-FIX			0.20	
Load Regulation	$\frac{\Delta V_{OUT}}{V_{OUT}}$	I _{OUT} = 5mA to 1.5A, (V _{IN} - V _{OUT}) = 3V, T _J = +25°C		0.04	0.3	%
		I _{OUT} = 5mA to 1.5A, (V _{IN} - V _{OUT}) = 3V			0.4	
		I _{OUT} = 0mA to 1.5A, (V _{IN} - V _{OUT}) = 3V, T _J = +25°C		0.04	0.3	
		I _{OUT} = 0mA to 1.5A, (V _{IN} - V _{OUT}) = 3V			0.4	
Dropout Voltage	V _{DROP}	I _{OUT} = 1.5A, ΔV _{OUT} = 1%		1.3	1.55	V
Output Current Limit	I _{LIMIT}	(V _{IN} - V _{OUT}) = 5V, ΔV _{OUT} = 5%	1.55	3		A
		(V _{IN} - V _{OUT}) = 25V, V _{OUT} = 0V	0.05	0.3		
Supply Pin Current	I _Q	V _{IN} = 30V, I _{OUT} = 0mA, SGM2217-FIX		2	5	mA
Minimum Load Current	I _{OUT_MIN}	V _{IN} = 30V, SGM2217-ADJ		2	5	mA
Turn-On Time	t _{ON}	From assertion of V _{IN} to V _{OUT} = 95% × V _{OUT(NOM)}		0.2	1	ms
Temperature Stability				0.5		%
Long Term Stability		1000 hours, T _J = +125°C		0.3		%
Power Supply Ripple Rejection	PSRR	ΔV _{RIPPLE} = 3V _{P-P} , (V _{IN} - V _{OUT}) = 3V, I _{OUT} = 1.5A, f _{RIPPLE} = 120Hz, C _{OUT} = 20μF	C _{ADJ} = 25μF, SGM2217-ADJ		72	dB
			V _{OUT} = 1.8V		68	
			V _{OUT} = 3.3V		64	
			V _{OUT} = 5.0V		60	
			V _{OUT} = 12V		53	
Output Voltage Noise	e _n	f = 10Hz to 10kHz, I _{OUT} = 1.5A		0.004		%
Thermal Regulation		30ms Pulse, T _J = +25°C		0.01	0.07	%/W
Thermal Shutdown Temperature	T _{SHDN}			160		°C
Thermal Shutdown Hysteresis	ΔT _{SHDN}			20		°C

TYPICAL PERFORMANCE CHARACTERISTICS

$T_J = +25^\circ\text{C}$, $(V_{IN} - V_{OUT}) = 3\text{V}$, $C_{IN} = C_{OUT} = 10\mu\text{F}$ (ceramic capacitor), unless otherwise noted.

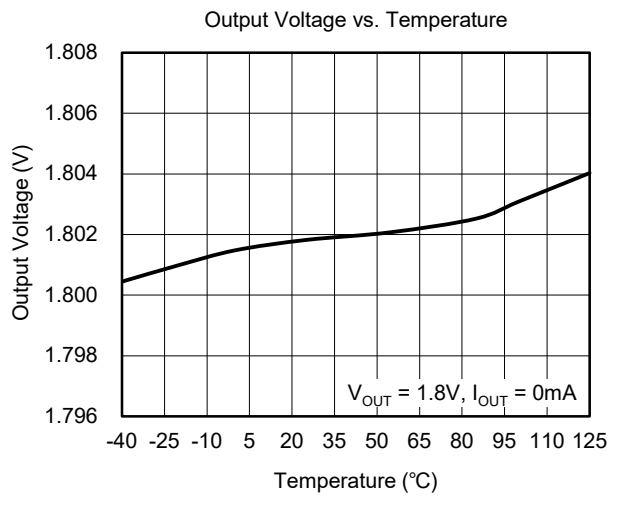
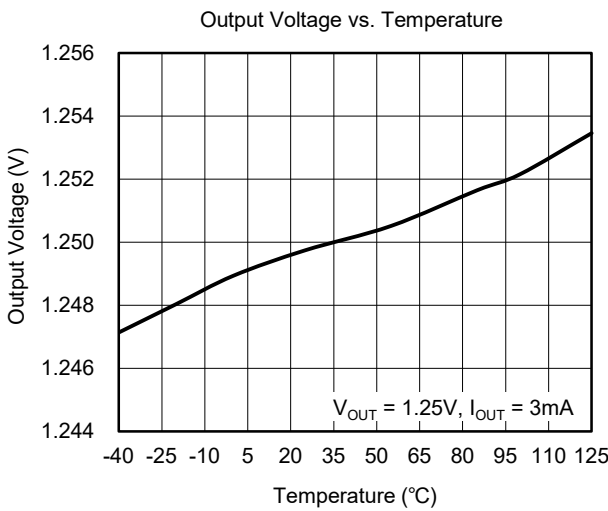
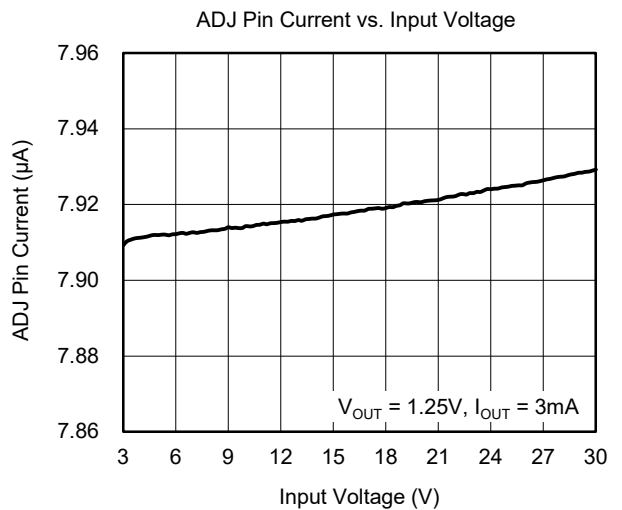
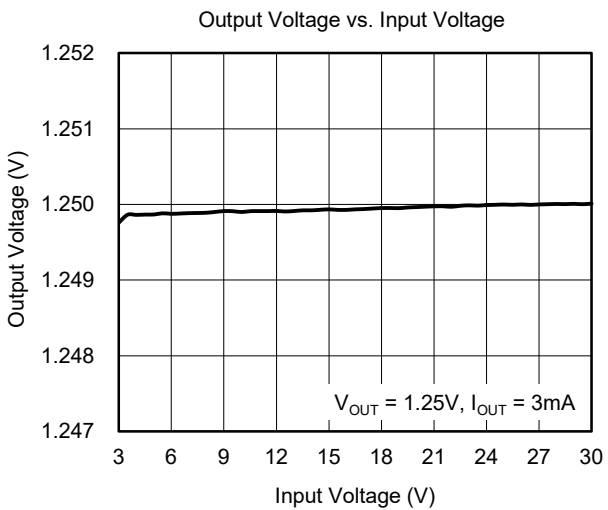
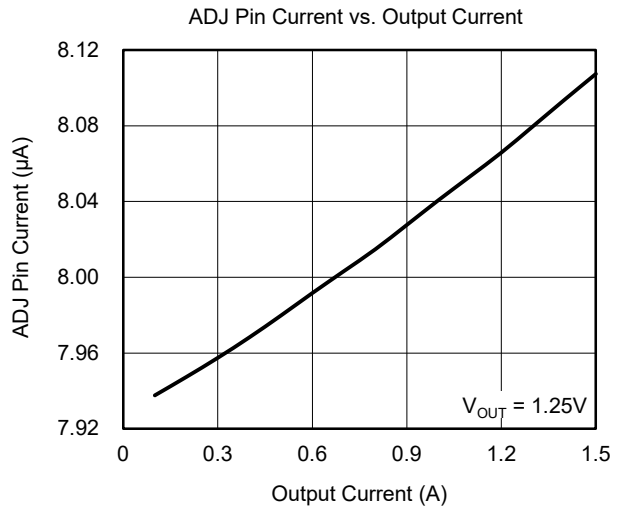
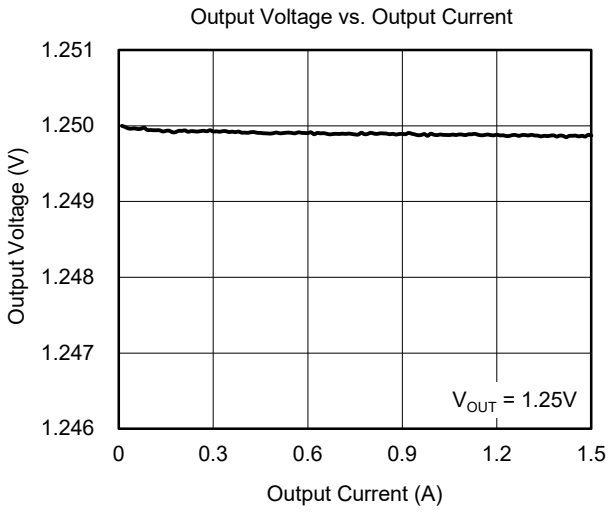

TYPICAL PERFORMANCE CHARACTERISTICS (continued)

$T_J = +25^\circ\text{C}$, $(V_{IN} - V_{OUT}) = 3\text{V}$, $C_{IN} = C_{OUT} = 10\mu\text{F}$ (ceramic capacitor), unless otherwise noted.

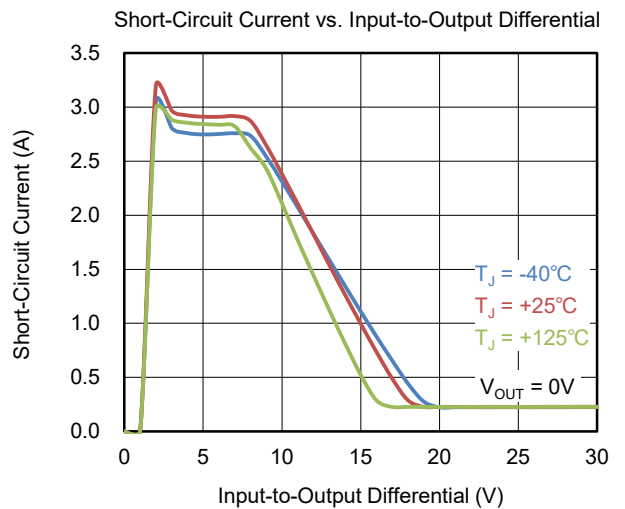
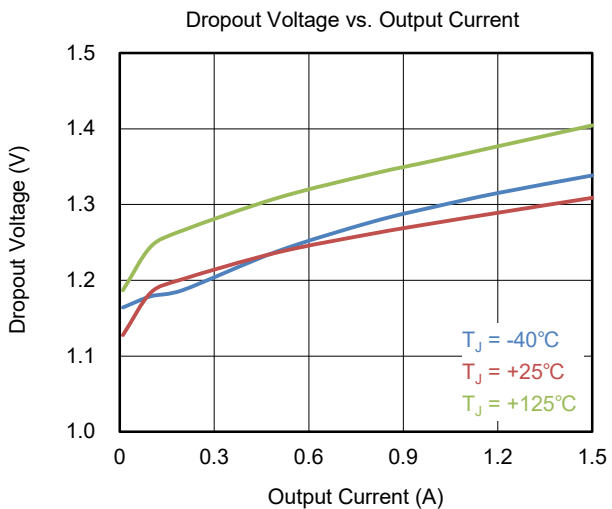
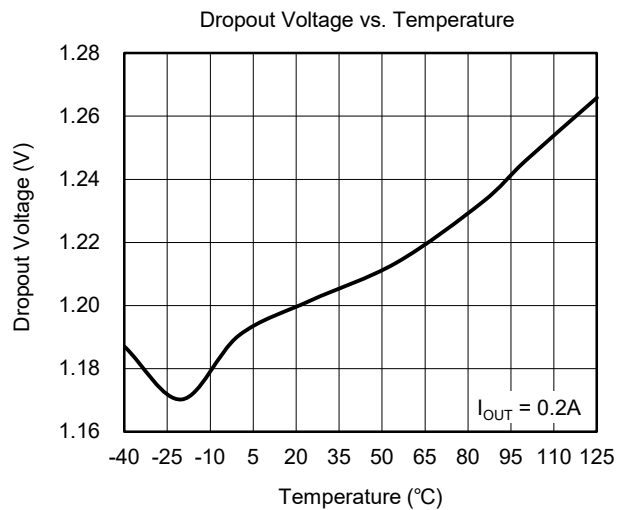
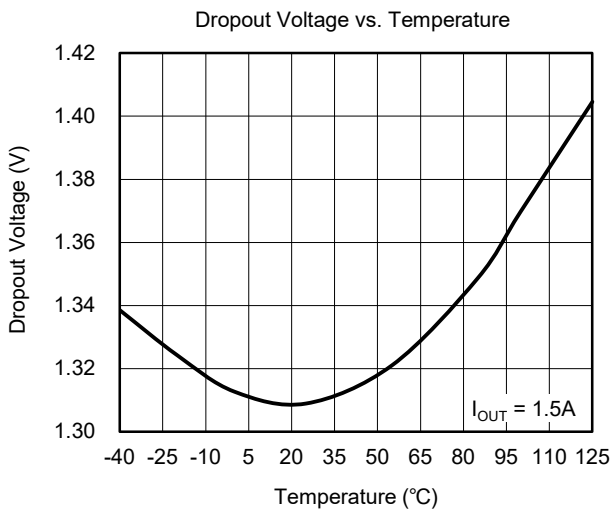
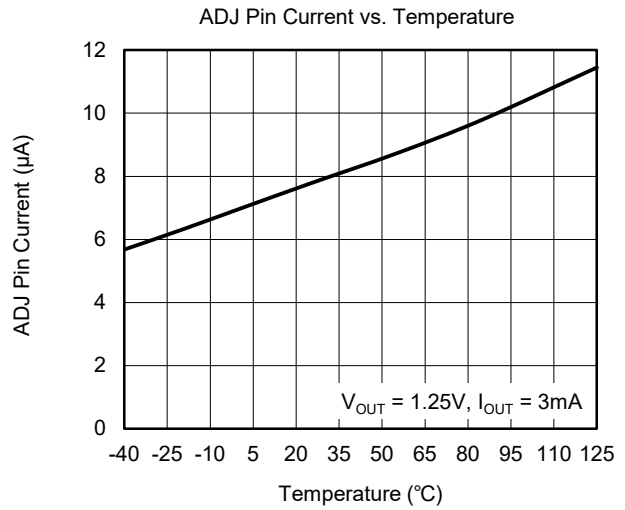
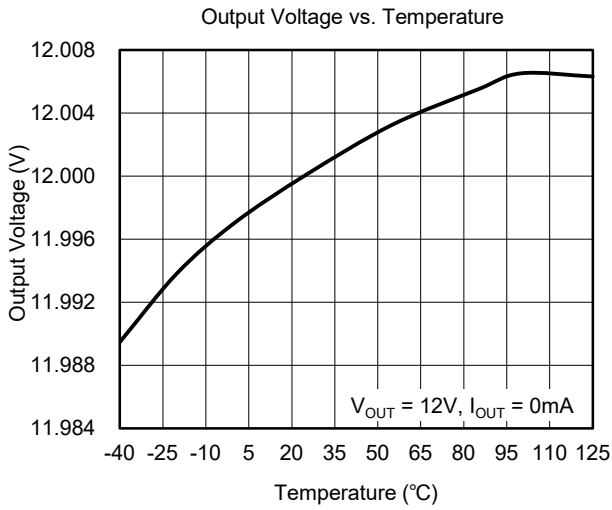

TYPICAL PERFORMANCE CHARACTERISTICS (continued)

T_J = +25°C, (V_{IN} - V_{OUT}) = 3V, C_{IN} = C_{OUT} = 10µF (ceramic capacitor), unless otherwise noted.

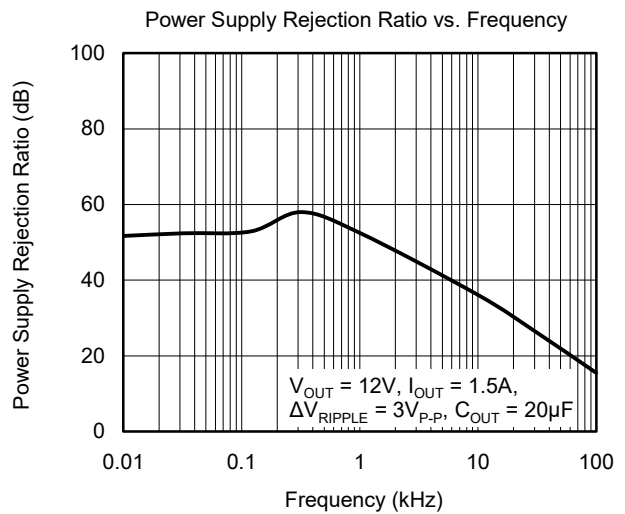
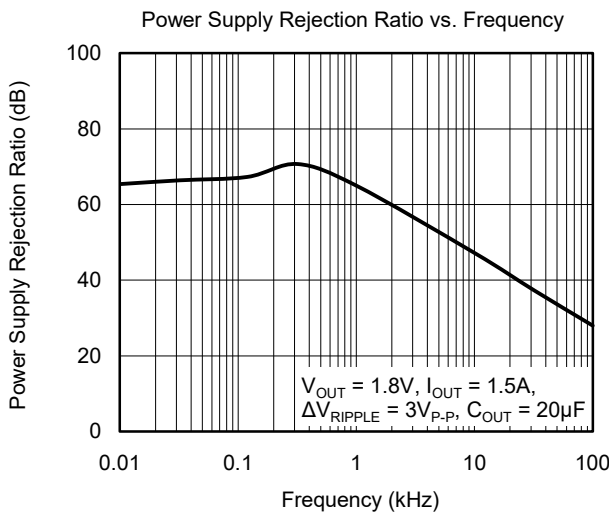
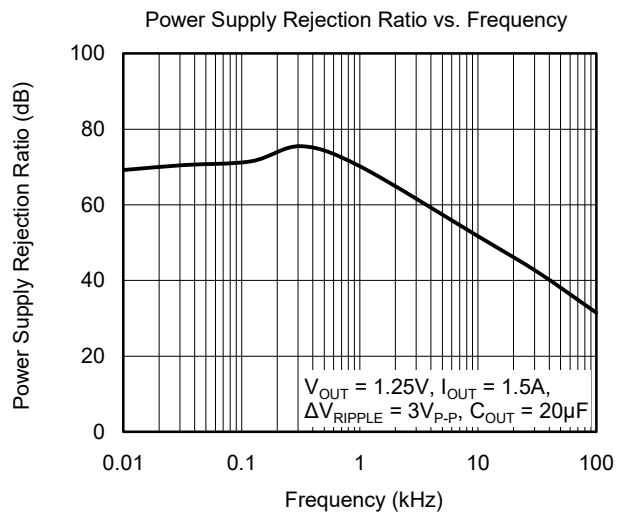
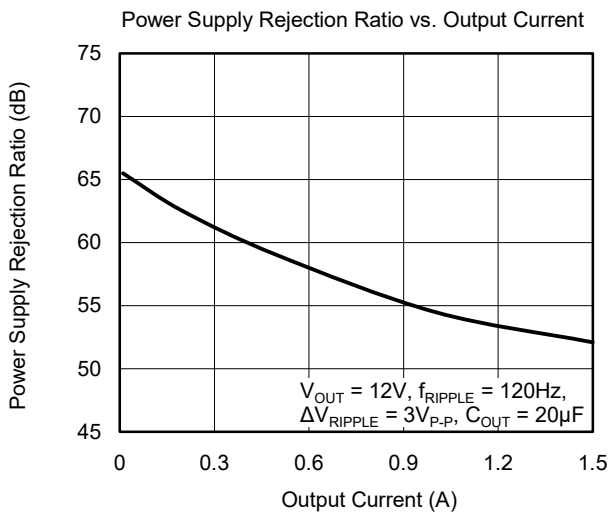
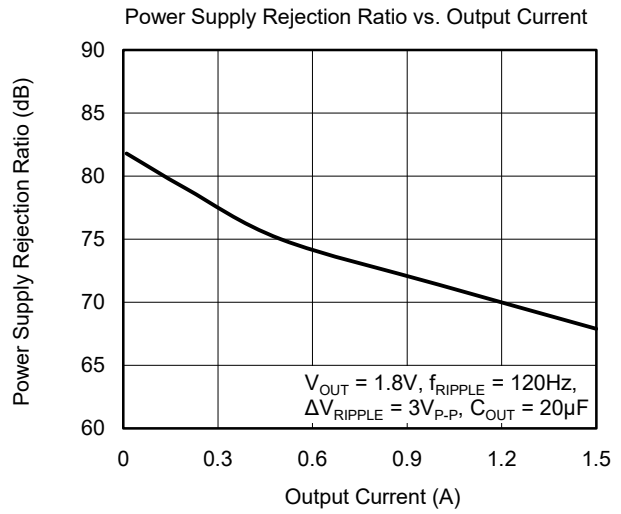
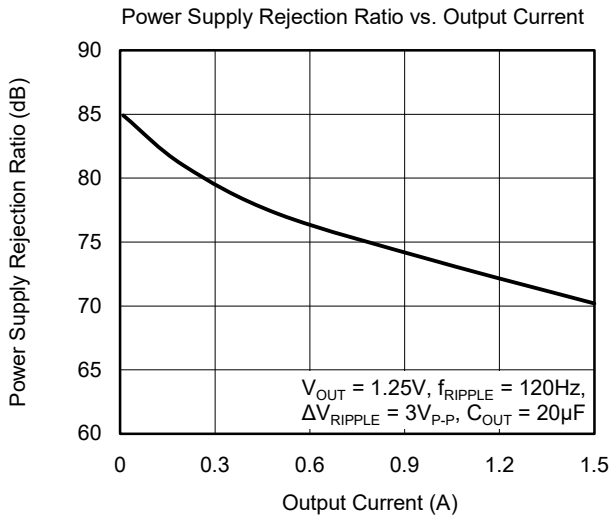

TYPICAL PERFORMANCE CHARACTERISTICS (continued)

$T_J = +25^\circ\text{C}$, $(V_{IN} - V_{OUT}) = 3\text{V}$, $C_{IN} = C_{OUT} = 10\mu\text{F}$ (ceramic capacitor), unless otherwise noted.

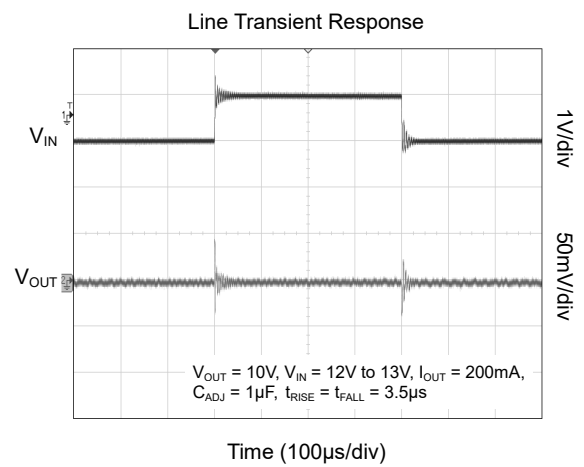
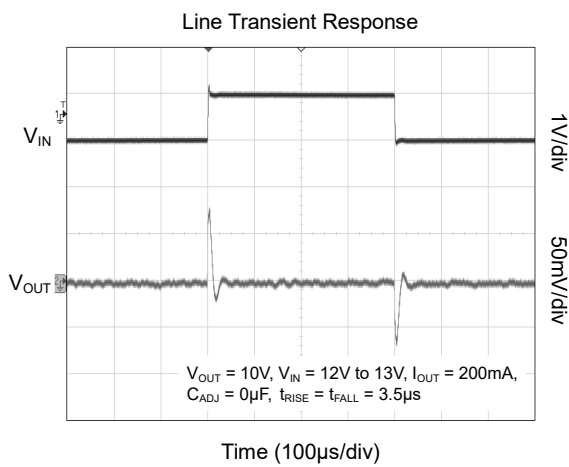
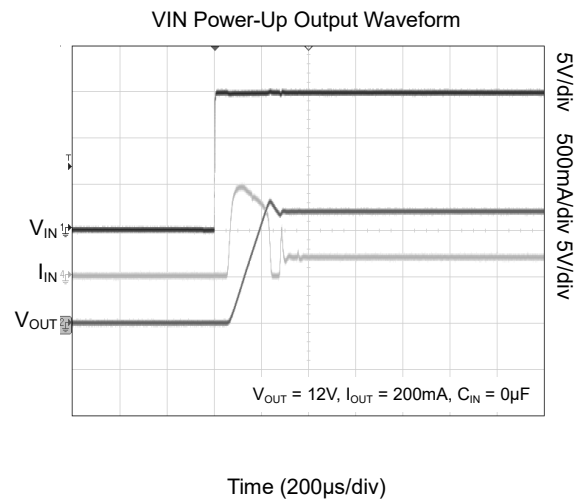
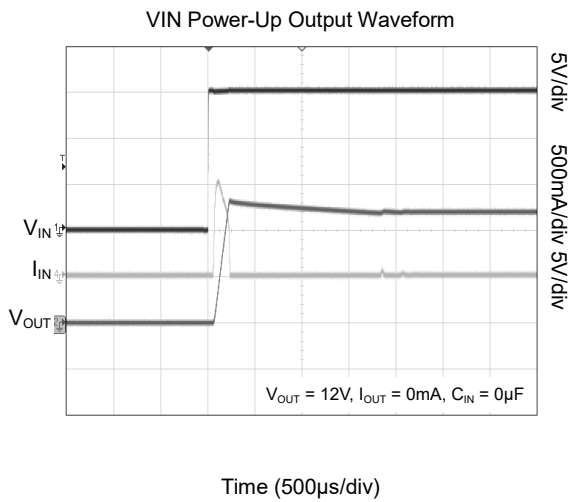
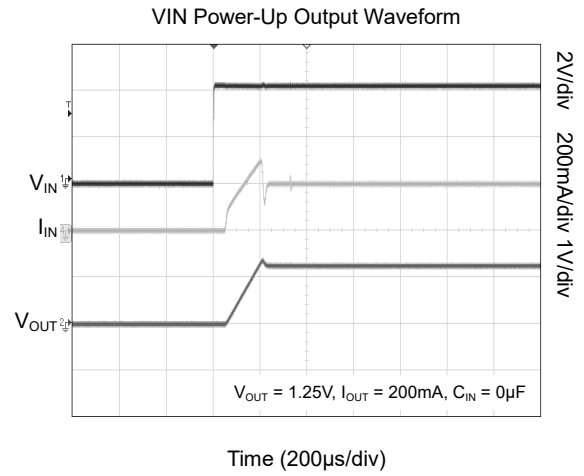
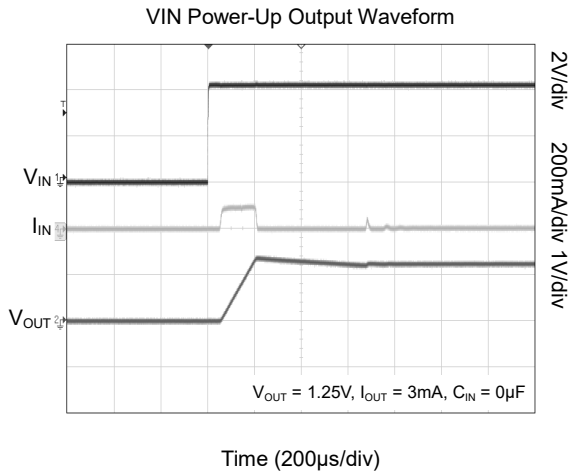

TYPICAL PERFORMANCE CHARACTERISTICS (continued)

$T_J = +25^\circ\text{C}$, $(V_{IN} - V_{OUT}) = 3\text{V}$, $C_{IN} = C_{OUT} = 10\mu\text{F}$ (ceramic capacitor), unless otherwise noted.

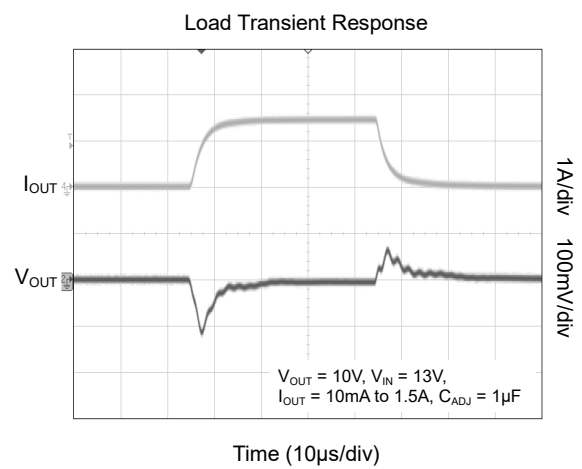
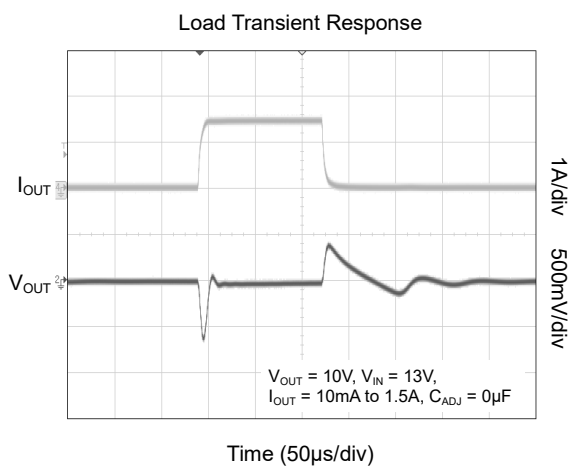
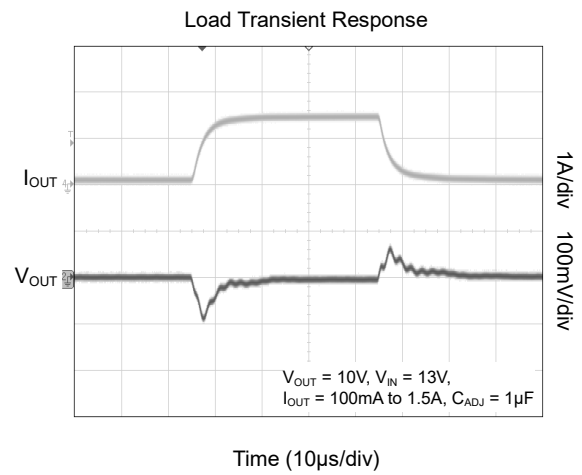
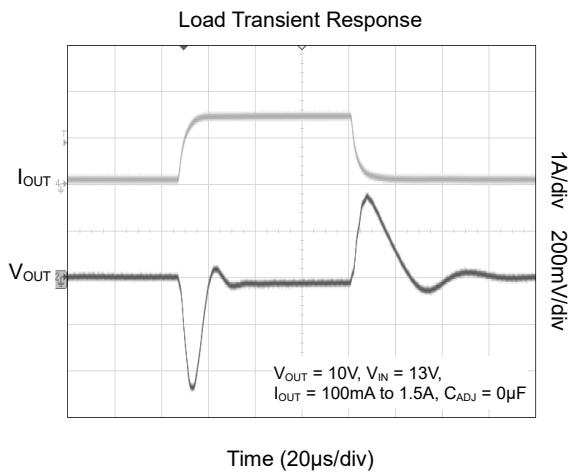
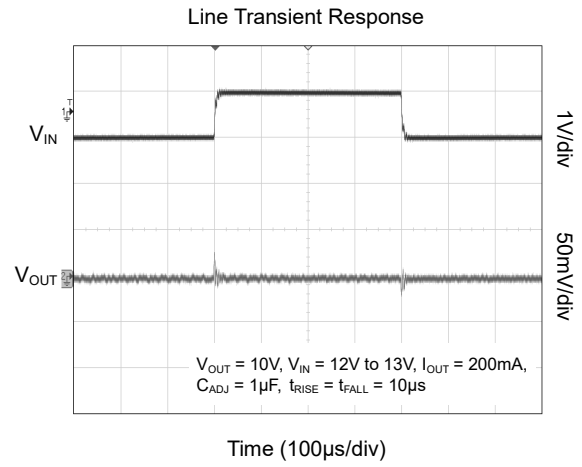
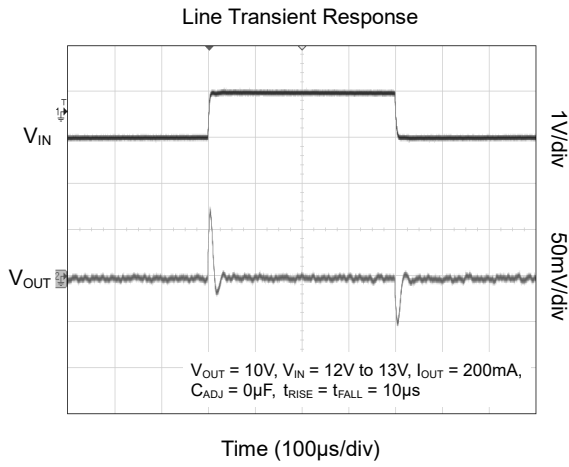

TYPICAL PERFORMANCE CHARACTERISTICS (continued)

$T_J = +25^\circ\text{C}$, $(V_{IN} - V_{OUT}) = 3\text{V}$, $C_{IN} = C_{OUT} = 10\mu\text{F}$ (ceramic capacitor), unless otherwise noted.

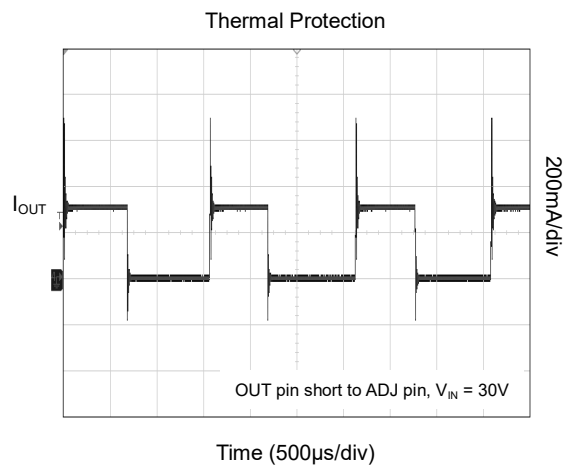
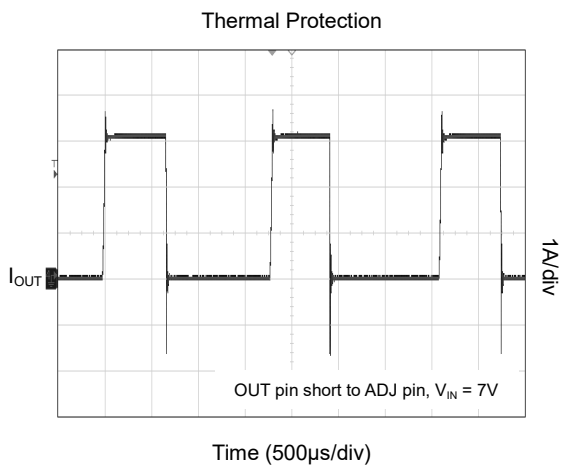

FUNCTIONAL BLOCK DIAGRAMS

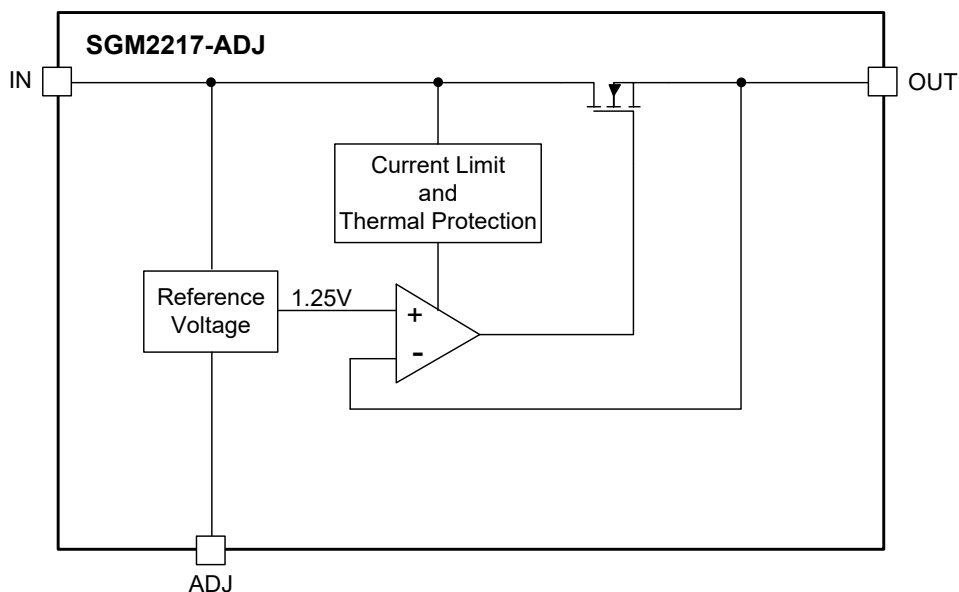

Figure 2. Adjustable Output Voltage Internal Block Diagram

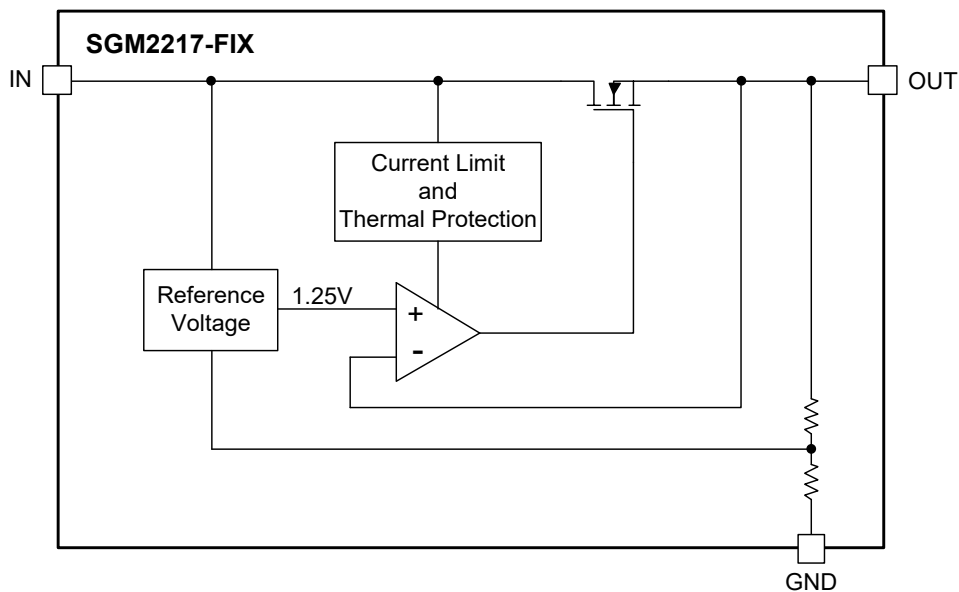

Figure 3. Fixed Output Voltage Internal Block Diagram

APPLICATION INFORMATION

The SGM2217 is a low noise, high current and low dropout LDO and provides 1.5A output current. These features make the device a reliable solution to solve many challenging problems in the generation of clean and accurate power supply. The high performance also makes the SGM2217 useful in a variety of applications. The SGM2217 provides protection functions for output overload, output short-circuit condition and overheating.

Input Capacitor Selection (C_{IN})

The input decoupling capacitor should be placed as close as possible to the IN pin for ensuring the device stability. 10 μ F or larger X7R or X5R ceramic capacitor is selected to get good dynamic performance.

When V_{IN} is required to provide large current instantaneously, a large effective input capacitor is required. Multiple input capacitors can limit the input tracking inductance. Adding more input capacitors is available to restrict the ringing and to keep it below the device absolute maximum ratings.

Output Capacitor Selection (C_{OUT})

The output decoupling capacitor should be placed as close as possible to the OUT pin. It is recommended to use output capacitor with effective capacitance in the range of 2.3 μ F to 100 μ F with an ESR of 8 Ω or less. For ceramic capacitor, temperature, DC bias and package size will change the effective capacitance, so enough margin of C_{OUT} must be considered in design. Additionally, C_{OUT} with larger capacitance and lower ESR will help increase the high frequency PSRR and improve the load transient response.

Output Current Limit and Short-Circuit Protection

The current limiting circuit reduces the output current as the input-to-output differential increases after 2ms of power-on. The current limit is reduced from 3A to 0.3A when the $V_{IN} - V_{OUT}$ voltage is greater than about 20V.

Adjustable Regulator

The output voltage of the SGM2217-ADJ can be adjusted from 1.25V to 26V. The ADJ pin will be connected to two external resistors as shown in Figure 4.

The PSRR and noise of adjustable LDO circuit can be modified slightly to levels close to that of the unity-gain LDO. The adjustment terminal can be bypassed to ground with a capacitor (C_{ADJ}). The impedance of the

C_{ADJ} should be equal to or less than R_2 at the desired frequency.

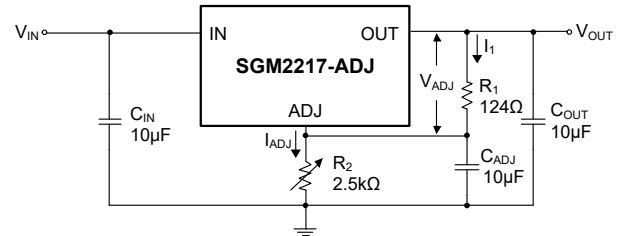

$$V_{OUT} = V_{ADJ} \times (1 + R_2/R_1) + I_{ADJ} \times R_2, I_1 = V_{ADJ}/R_1$$

But I_{ADJ} is far less than I_1 , so $V_{OUT} = V_{ADJ} \times (1 + R_2/R_1)$.
Where V_{OUT} is output voltage and $V_{ADJ} = 1.25V$.

Figure 4. Adjustable Output Voltage Application

Reverse Current Protection

The SGM2217 doesn't incorporate reverse current protection circuit, must add protection diodes prevents current flow backwards through the pass element when the output voltage is greater than the input voltage.

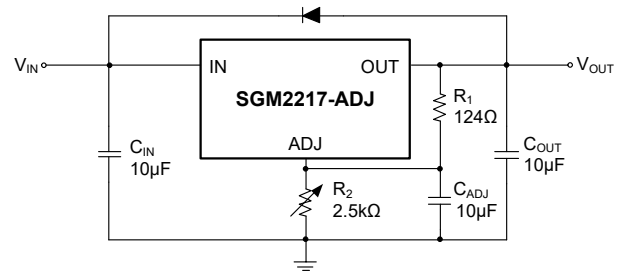

Figure 5. Protection Diodes Application

Thermal Shutdown

The SGM2217 can detect the temperature of die. When the die temperature exceeds the threshold value of thermal shutdown, the SGM2217 will be in shutdown state and it will remain in this state until the die temperature decreases to +140°C.

Power Dissipation (P_D)

Power dissipation (P_D) of the SGM2217 can be calculated by the equation $P_D = (V_{IN} - V_{OUT}) \times I_{OUT}$. The maximum allowable power dissipation ($P_{D(MAX)}$) of the SGM2217 is affected by many factors, including the difference between junction temperature and ambient temperature ($T_{J(MAX)} - T_A$), package thermal resistance from the junction to the ambient environment (θ_{JA}), the rate of ambient airflow and PCB layout. $P_{D(MAX)}$ can be approximated by the following equation:

$$P_{D(MAX)} = (T_{J(MAX)} - T_A)/\theta_{JA} \quad (1)$$

REVISION HISTORY

NOTE: Page numbers for previous revisions may differ from page numbers in the current version.

AUGUST 2023 – REV.A to REV.A.1	Page
Updated Application Information section.....	13

Changes from Original (JUNE 2021) to REV.A	Page
Changed from product preview to production data.....	All

PACKAGE OUTLINE DIMENSIONS

TO-263-3A

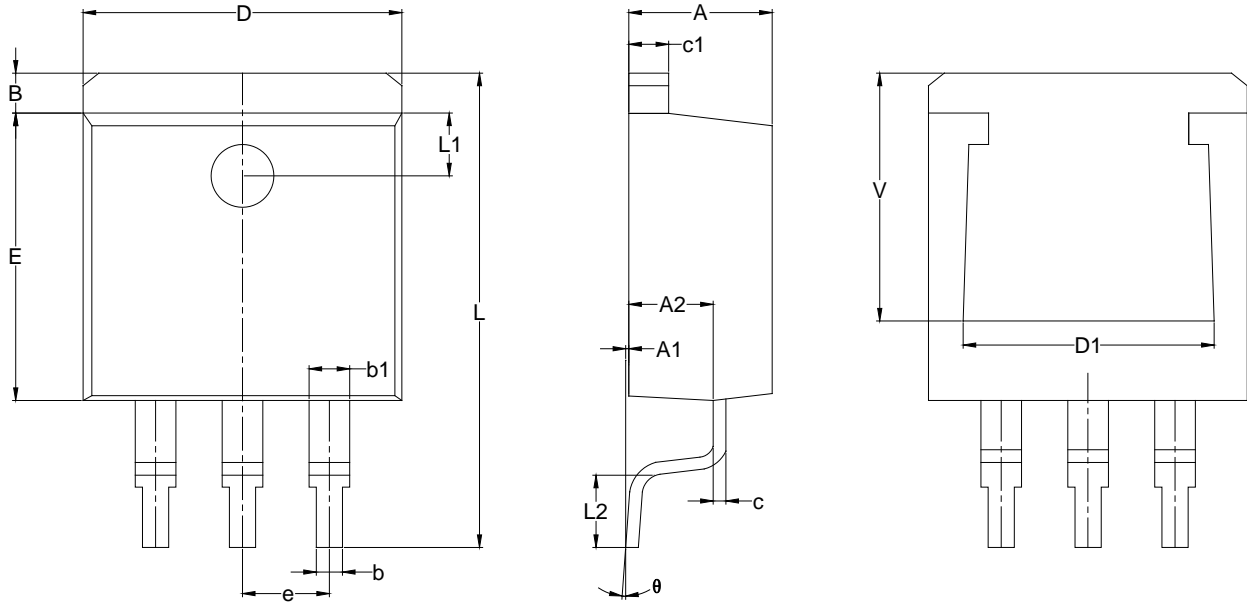

Symbol	Dimensions In Millimeters		
	MIN	MOD	MAX
A	4.400	4.570	4.700
A1	0.000	0.100	0.250
A2	2.590	2.690	2.790
B	1.170	1.270	1.400
b	0.770	-	0.900
b1	1.230	-	1.360
c	0.340	-	0.470
c1	1.220	-	1.320
D	10.060	10.160	10.260
D1	7.800	-	8.200
E	9.050	9.150	9.250
e	2.540 BSC		
L	14.700	15.100	15.500
L1	2.000 REF		
L2	2.000	2.300	2.600
V	6.600	-	-
θ	0°		8°

- NOTES:
 1. Body dimensions do not include mode flash or protrusion.
 2. This drawing is subject to change without notice.

PACKAGE OUTLINE DIMENSIONS

TDFN-4x4-8L

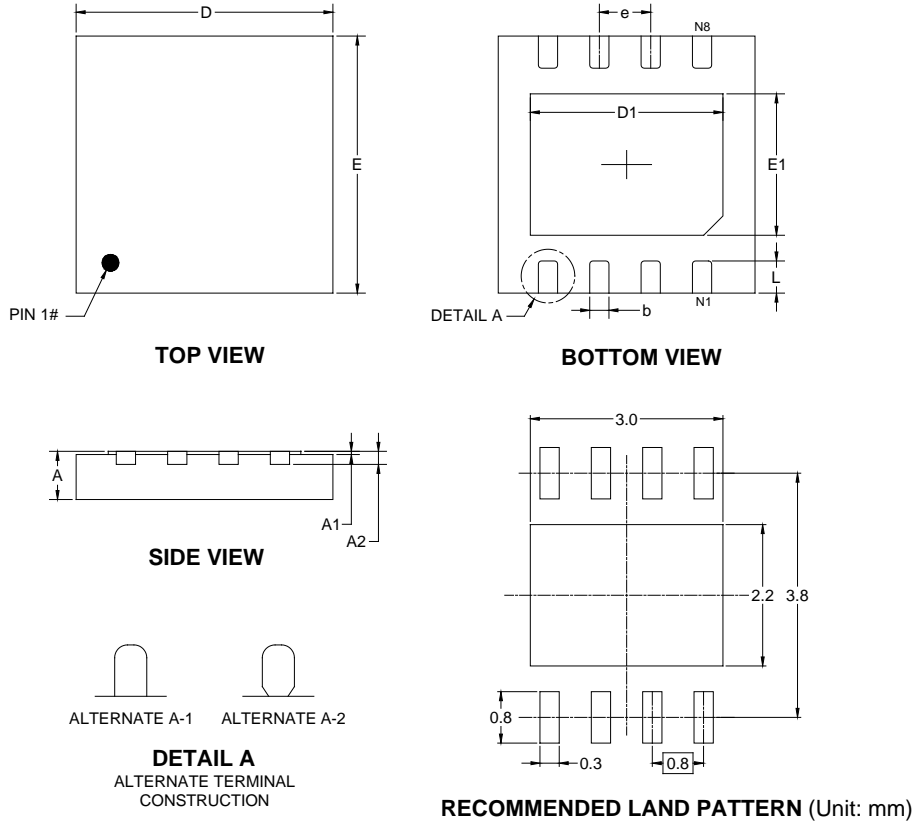

Symbol	Dimensions In Millimeters		
	MIN	MOD	MAX
A	0.700	0.750	0.800
A1	-	-	0.050
A2	0.203 REF		
D	3.950	4.000	4.050
D1	2.950	3.000	3.050
E	3.950	4.000	4.050
E1	2.150	2.200	2.250
b	0.250	0.300	0.350
e	0.800 BSC		
L	0.450	0.500	0.550

NOTE: This drawing is subject to change without notice.

TAPE AND REEL INFORMATION

REEL DIMENSIONS



TAPE DIMENSIONS



NOTE: The picture is only for reference. Please make the object as the standard.

KEY PARAMETER LIST OF TAPE AND REEL

Package Type	Reel Diameter	Reel Width W1 (mm)	A0 (mm)	B0 (mm)	K0 (mm)	P0 (mm)	P1 (mm)	P2 (mm)	W (mm)	Pin1 Quadrant
TO-263-3A	13"	24.4	10.80	16.30	5.11	4.0	16.0	2.0	24.0	
TDFN-4x4-8L	13"	12.4	4.30	4.30	1.10	4.0	8.0	2.0	12.0	Q2

1000001

PACKAGE INFORMATION

CARTON BOX DIMENSIONS



NOTE: The picture is only for reference. Please make the object as the standard.

KEY PARAMETER LIST OF CARTON BOX

Reel Type	Length (mm)	Width (mm)	Height (mm)	Pizza/Carton
13"	386	280	370	5

DD0002